

Зип Общепит

vsezip.ru

+7(812)987-08-81



**04WVT1IV**

**Edition 20131004-**

Зип Общепит

vsezip.ru

+7(812)987-08-81

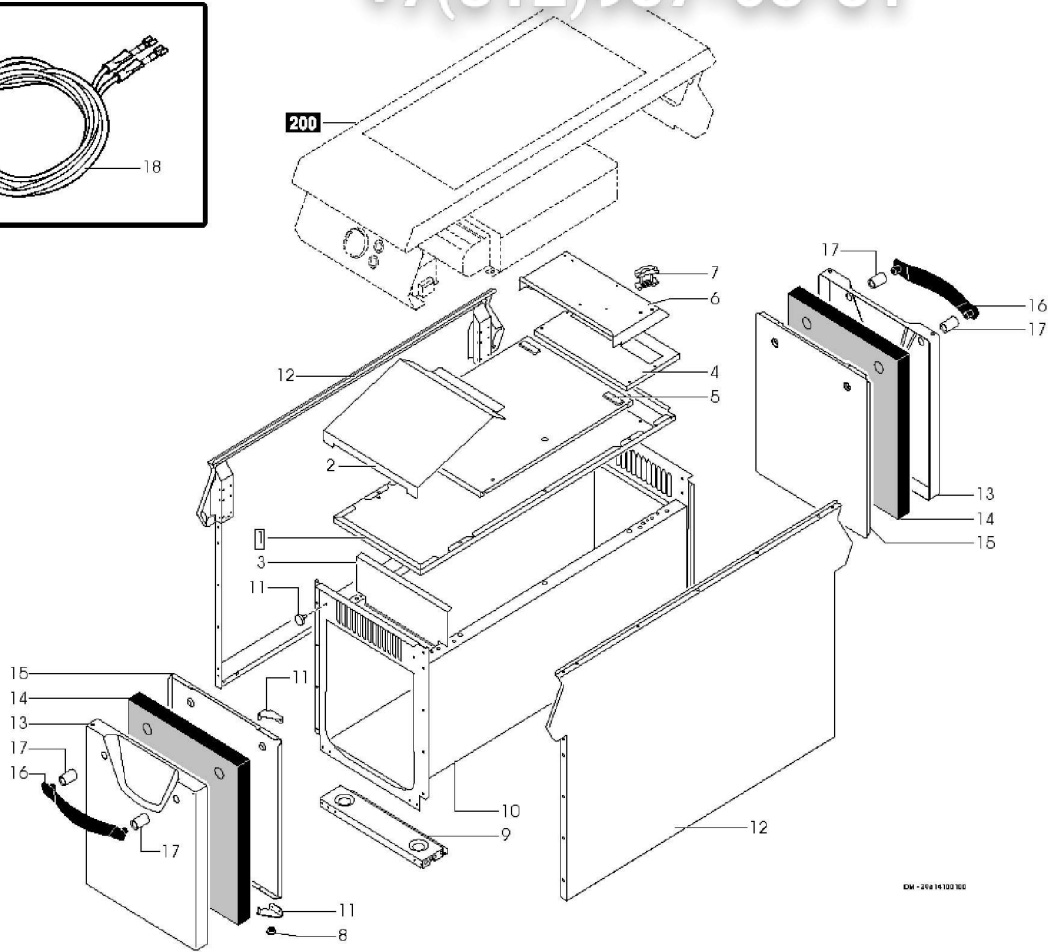
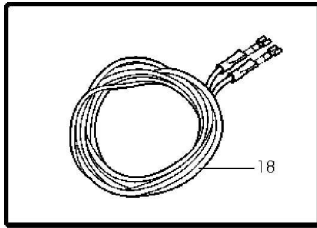

EM-200 16 100 80

Зип Общепит

vsezip.ru

+7(812)987-08-81

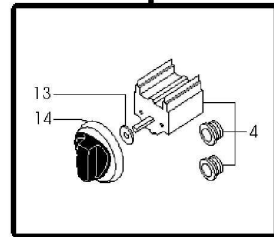
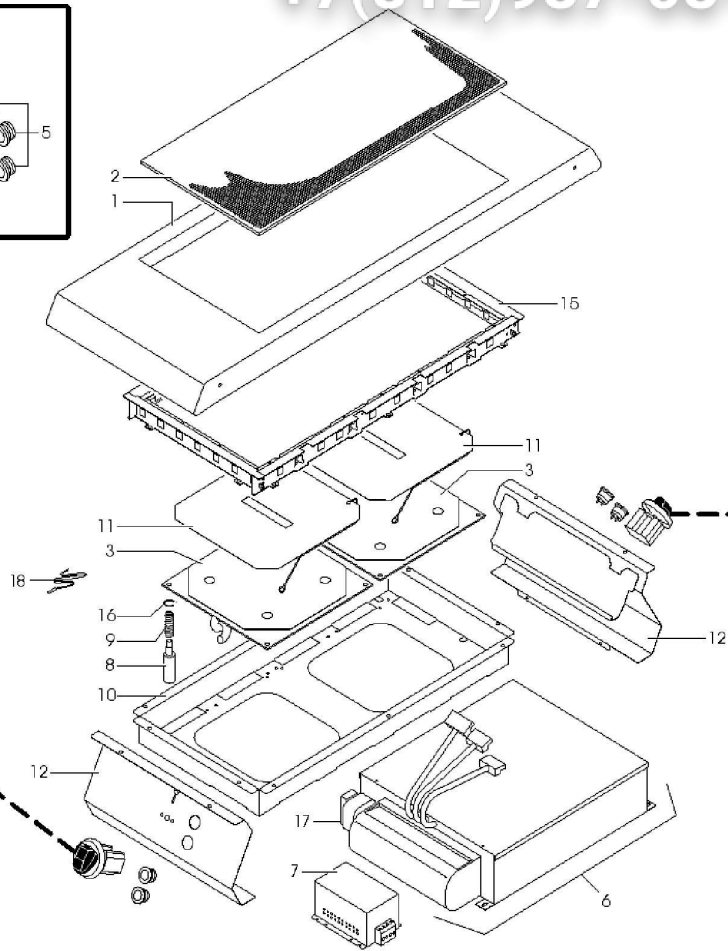
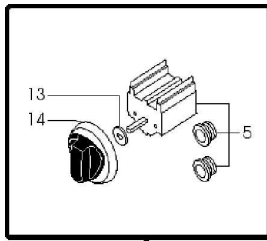

| Page | Pos | Code    | Description                         | Info        |
|------|-----|---------|-------------------------------------|-------------|
| 002  | 001 | 3030980 | CUP BOARD CEILING                   | 08/11/2004- |
| 002  | 002 | 3017350 | AIR CONVEYOR                        | 08/11/2004- |
| 002  | 003 | 3017330 | PROTECTION                          | 08/11/2004- |
| 002  | 004 | 3017320 | SUPPORT                             | 08/11/2004- |
| 002  | 005 | 3017380 | SUPPORT                             | 08/11/2004- |
| 002  | 006 | 3030950 | AIR CONVEYOR                        | 08/11/2004- |
| 002  | 007 | 32D1820 | CABLE CLAMP                         | 08/11/2004- |
| 002  | 008 | 3011000 | BUSHING                             | 08/11/2004- |
| 002  | 009 | 35R1452 | PROFILE OMEGA                       | 08/11/2004- |
| 002  | 010 | 3017420 | UNDERCOMPARTMENT                    | 08/11/2004- |
| 002  | 011 | 6029110 | HINGE ASSEMBLY                      | 19/05/2010- |
| 002  | 012 | 3030800 | PANEL                               | 08/11/2004- |
| 002  | 013 | 3177270 | OVAL DOOR                           | 19/05/2010- |
| 002  | 014 | 3011060 | INSULANTING PANEL                   | 08/11/2004- |
| 002  | 015 | 3010510 | COUNTER DOOR                        | 08/11/2004- |
| 002  | 016 | 3010573 | HANDLE                              | 04/10/2013- |
| 002  | 017 | 3011050 | SPACER                              | 08/11/2004- |
| 002  | 018 | 3009720 | EL. CABLES                          | 08/11/2004- |
| 002  | 200 | M023491 | M.TOP                               | 08/11/2004- |
| 003  | 001 | 3016500 | HOB                                 | 08/11/2004- |
| 003  | 002 | 36A5420 | GLASS FOR INDUCTION HOB             | 08/11/2004- |
| 003  | 003 | 3039290 | 5 Kw INDUCTOR 400V/3/50Hz           | 08/11/2004- |
| 003  | 004 | 3037910 | COMMUTATOR 8 POS. + PILOT LIGH      | 08/11/2004- |
| 003  | 005 | 3037920 | COMMUTATOR 10 POS. + PILOT LIG      | 08/11/2004- |
| 003  | 006 | 3001250 | INDUCTION GENERATOR 5+5KW           | 08/11/2004- |
| 003  | 007 | 3037840 | 400V FILTER                         | 08/11/2004- |
| 003  | 008 | 33Q5000 | SUPPORT                             | 08/11/2004- |
| 003  | 009 | 3007410 | TORSION SPRING                      | 08/11/2004- |
| 003  | 010 | 3033110 | INDUCTION STRUCTURE                 | 08/11/2004- |
| 003  | 011 | 3001320 | FILTER                              | 08/11/2004- |
| 003  | 012 | 3030821 | UPPER CONTROL BOARD                 | 08/11/2004- |
| 003  | 013 | 3152240 | THERMOSTAT PROTECT.                 | 08/11/2004- |
| 003  | 014 | 3015991 | HANDLE                              | 14/03/2008- |
| 003  | 015 | 3033101 | SUPPORT                             | 02/12/2011- |
| 003  | 016 | 3120460 | SEAL RING                           | 08/11/2004- |
| 003  | 017 | 3023200 | TANGENTIAL FAN                      | 08/11/2004- |
| 003  | 018 | 6300774 | TEMP.PROBE PT1000 + TAPE FOR FIXING | 08/11/2004- |