



Зип Общепит

vsezip.ru

+7(812)987-08-81



**GAS COMPONENTS**



**ELECTRIC COMPONENTS**



**WATER TECHNOLOGY**



**MECHANICAL COMPONENTS**



**TOOLS**

Spare parts suitable for

**FAGOR**

Find the complete and up-to-date range of products in our GEV Webshop

Зип Общепит

vsezip.ru

+7(812)987-08-81

# Manufacturer catalogue

The most important spare parts and accessories arranged clearly for every manufacturer



**Complete product range and all appliance data always up to date in the GEV Webshop**



**Alphabetical Index at the end of the catalogue**







## GEV Webshop

[www.gev-online.co.uk](http://www.gev-online.co.uk)

[www.gev-online.com](http://www.gev-online.com)





-  Add to Favourites
-  Sign In with email address and usual password
-  Easy-order – place several items in your basket at the same time
-  Quick item search – no login needed



# heating elements





## heating elements for ovens

|   |   |                 |                     |
|---|---|-----------------|---------------------|
|  |   |                 |                     |
| <b>GEV No.</b>  | 416018  | <b>Ref. No.</b> | 12024610<br>U803004 |
| <b>description</b>  | heating element 1000W 230V L 515mm W 125mm L1 55mm L2 460mm W1 65mm W2 60mm flange length 80mm flange width 20mm tube ø 6.5mm connection length 50mm connection male faston 6.3mm heating circuits 1 rectangular flange dry heating element |                 |                     |
| <b>For models:</b>  | CE7-41, CE7-41Q, CE9-41, CE9-41AD, CE9-41PLUS, CG-210G, CG-310G, CGE7-224, CGE7-41, CGE7-41H, CGE9-11, CGE9-41, CGE9-41AD, CGE9-41PLUS, HE9-10, HE9-20  |                 |                     |

|   |  |                 |                     |
|---|--|-----------------|---------------------|
|  |  |                 |                     |
| <b>GEV No.</b>  | 416608   | <b>Ref. No.</b> | 12018965<br>U183030 |
| <b>description</b>  | heating element 1000W 230V L 515mm W 170mm L1 70mm L2 445mm W1 110mm W2 60mm flange length 80mm flange width 20mm tube ø 6.3mm connection length 50mm connection male faston 6.3mm heating circuits 1 rectangular flange dry heating element |                 |                     |
| <b>For models:</b>  | CE-410, CE9-41   |                 |                     |

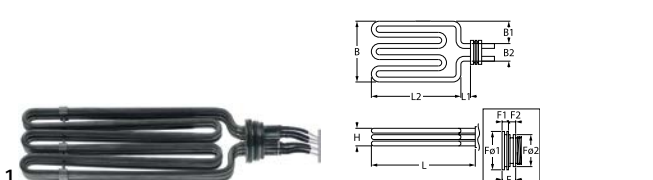
## heating elements for fryers

### center connection

|   |   |                 |                   |
|---|---|-----------------|-------------------|
|  |   |                 |                   |
| <b>GEV No.</b>  | 416824  | <b>Ref. No.</b> | FAG6000001        |
| <b>description</b>  | heating element 7000W 230/400V heating circuits 3 L 325mm W 110mm H 33mm flange length 19.5mm flange length 1 9.5mm flange length 2 9.8mm flange ø1 62mm flange ø2 57mm thermostat sleeves ø 8mm sensor screw connection 2x M10x1 thermostat sleeve upper/lower L1 18mm L2 307mm W1 40mm W2 35mm thread M54x1.5 tube ø 8.5mm cable length 520mm rotation flange immersion heater fryer connection length 50mm 2 |                 |                   |
| <b>spare parts for</b>  | 416824  |                 |                   |
|   | <b>GEV No.</b>  | 510243          | <b>Ref. No.</b> — |
|  | O-ring Viton thickness 3.53mm ID ø 55.56mm Qty 1 pcs  |                 |                   |
|   | <b>GEV No.</b>  | 550496          | <b>Ref. No.</b> — |
|  | O-ring Viton thickness 3.53mm ID ø 50.39mm Qty 1 pcs  |                 |                   |
| <b>accessories for</b>  | 416824  |                 |                   |
|   | <b>GEV No.</b>  | 550447          | <b>Ref. No.</b> — |
|  | ring nut thread M54x1.5   |                 |                   |

Зип Общепит

vsezip.ru

+7(812)987-08-81

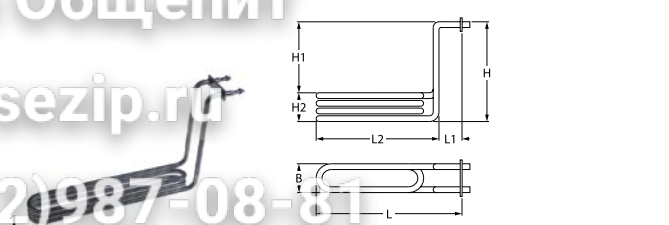
|  |  |                 |         |
|--|--|-----------------|---------|
|  |  |                 |         |
| <b>GEV No.</b>   | 416624   | <b>Ref. No.</b> | X363023 |
| <b>description</b>   | heating element 1500W 230V heating circuits 1 L 300mm W 50mm H 180mm L1 20mm L2 280mm H1 150mm H2 30mm windings 3 flange length 56mm flange width 16mm hole distance 18mm hole ø 5mm mounting thread M4 tube ø 8mm |                 |         |

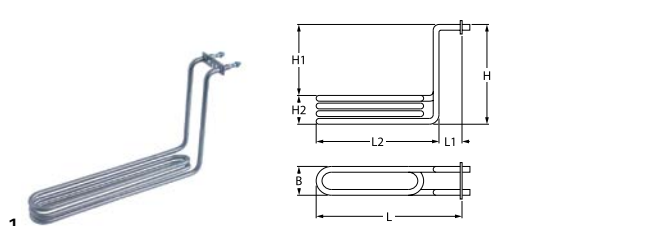
|  |  |                 |         |
|--|--|-----------------|---------|
|  |  |                 |         |
| <b>GEV No.</b>   | 416628   | <b>Ref. No.</b> | X373005 |
| <b>description</b>   | heating element 2000W 230V heating circuits 1 L 298mm W 49mm H 179mm L1 19mm L2 279mm H1 150mm H2 31mm windings 3 flange length 56mm flange width 16mm hole distance 18mm hole ø 5mm connection M4 connection length 23mm tube ø 8mm rectangular flange immersion heater |                 |         |

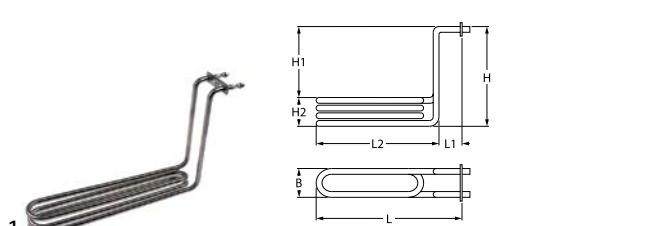
|   |   |                 |                     |
|---|---|-----------------|---------------------|
|  |   |                 |                     |
| <b>GEV No.</b>  | 416625  | <b>Ref. No.</b> | 12024654<br>X373022 |
| <b>description</b>  | heating element 2000W 230V heating circuits 1 L 310mm W 50mm H 180mm L1 30mm L2 280mm H1 150mm H2 30mm windings 3 flange length 56mm flange width 16mm hole distance 18mm hole ø 5mm connection M4 tube ø 8mm rectangular flange immersion heater |                 |                     |
| <b>For models:</b>  | FE-8  |                 |                     |

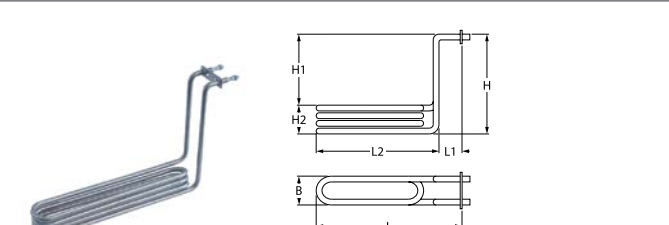
|  |   |                 |  |
|--|---|-----------------|--|
|  |   |                 |  |
| <b>GEV No.</b>   | 416622  | <b>Ref. No.</b> | 12024670<br>12039909<br>X353005<br>X353024 |
| <b>description</b>   | heating element 3000W 230V heating circuits 1 L 303mm W 45mm H 190mm L1 20mm L2 283mm H1 148mm H2 42mm windings 4 flange length 56mm flange width 16mm hole distance 18mm hole ø 5mm connection M4 connection length 35mm tube ø 8mm rectangular flange fryer |                 |  |
| <b>For models:</b>   | FE-4  |                 |  |

electric components



Зип Общепит

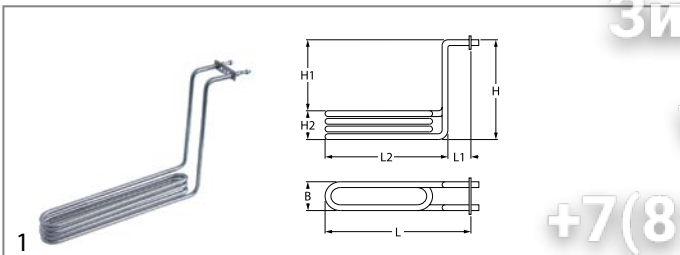

vsezip.ru

+7(812)987-08-81

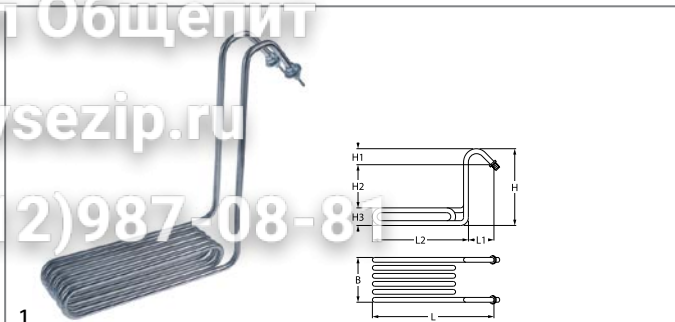

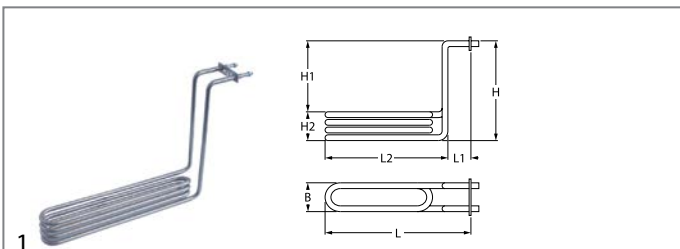

|  |   |                 |                     |
|--|---|-----------------|---------------------|
|  |   |                 |                     |
| <b>GEV No.</b>   | 416630  | <b>Ref. No.</b> | 12024695<br>X383020 |
| <b>description</b>   | heating element 3000W 230V heating circuits 1 L 342mm W 48mm H 220mm L1 47mm L2 295mm H1 174mm H2 46mm windings 4 flange length 56mm flange width 16mm hole distance 18mm hole $\varnothing$ 5mm connection M4 connection length 32mm tube $\varnothing$ 8.5mm rectangular flange immersion heater AISI 304 |                 |                     |
| <b>For models:</b>   | FE-18   |                 |                     |

|  |   |                 |  |
|--|---|-----------------|--|
|  |   |                 |  |
| <b>GEV No.</b>   | 417160  | <b>Ref. No.</b> | 12000058<br>12024757<br>X183021<br>X183068 |
| <b>description</b>   | heating element 6000W 230V heating circuits 1 L 380mm W 90mm H 355mm L1 85mm L2 295mm H1 35mm H2 268mm H3 52mm thread M15x1 tube $\varnothing$ 10mm 2 hole fixing connection M4 immersion heater windings 6 |                 |  |
| <b>For models:</b>   | FE9-05, FE9-05-1C, FE9-05-2C, FE9-05AD, FE9-05PLUS, FE9-05PLUS-S, FE9-05S, FE9-05S-1C, FE9-05S-2C, FE9-05S-AD, FE9-05USMC, FE9-10, FE9-10-2C, FE9-10-4C, FE9-10AD, FE9-10PLUS                               |                 |  |

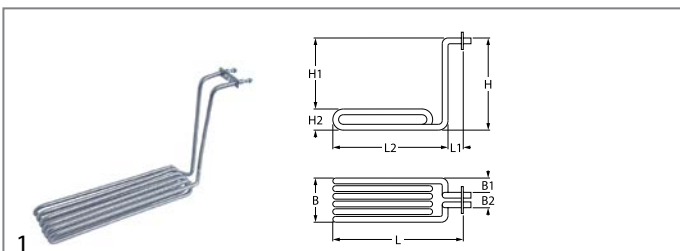
|  |                                  |                 |         |
|--|----------------------------------|-----------------|---------|
|  |                                  |                 |         |
| <b>GEV No.</b>   | 416631                           | <b>Ref. No.</b> | X393010 |
| <b>description</b>   | heating element 4250W windings 4 |                 |         |

|   |   |        |                   |
|---|---|--------|-------------------|
| <b>description</b>  | heating element 6000W 230V heating circuits 1 L 380mm W 90mm H 355mm L1 85mm L2 295mm H1 35mm H2 268mm H3 52mm thread M15x1 tube $\varnothing$ 10mm 2 hole fixing connection M4 immersion heater windings 6 |        |                   |
| <b>For models:</b>  | FE9-05, FE9-05-1C, FE9-05-2C, FE9-05AD, FE9-05PLUS, FE9-05PLUS-S, FE9-05S, FE9-05S-1C, FE9-05S-2C, FE9-05S-AD, FE9-05USMC, FE9-10, FE9-10-2C, FE9-10-4C, FE9-10AD, FE9-10PLUS                               |        |                   |
| <b>spare parts for</b>  | 417160  |        |                   |
|  | <b>GEV No.</b>  | 508017 | <b>Ref. No.</b> — |
|   | flat gasket FIBER ED $\varnothing$ 24mm ID $\varnothing$ 17mm thickness 2mm Qty 1 pcs   |        |                   |
|  | <b>GEV No.</b>  | 528401 | <b>Ref. No.</b> — |
|   | flat gasket fibre ED $\varnothing$ 22mm ID $\varnothing$ 16mm thickness 2mm Qty 1 pcs   |        |                   |

|   |   |                 |                     |
|---|---|-----------------|---------------------|
|  |   |                 |                     |
| <b>GEV No.</b>  | 416632  | <b>Ref. No.</b> | 12024745<br>X393021 |
| <b>description</b>  | heating element 4250W 230V heating circuits 1 L 380mm W 104mm H 230mm L1 46mm L2 335mm W1 28mm W2 48mm H1 194mm H2 40mm windings 6 flange length 57mm flange width 17mm hole distance 18mm hole $\varnothing$ 5mm connection M4 connection length 35mm tube $\varnothing$ 8.5mm rectangular flange immersion heater |                 |                     |
| <b>For models:</b>  | FE-25   |                 |                     |

|   |   |        |                                     |
|---|---|--------|-------------------------------------|
| <b>accessories for</b>  | 417160  |        |                                     |
|  | <b>GEV No.</b>  | 401703 | <b>Ref. No.</b> 12024416<br>X183070 |
|   | copper wire 4mm <sup>2</sup> insulation glass fibre connection cable lug $\varnothing$ 4mm L 1400mm           |        |                                     |
|  | <b>GEV No.</b>  | 521103 | <b>Ref. No.</b> —                   |
|   | nut thread M4 H 3mm WS 7 brass Qty 20 pcs   |        |                                     |
|  | <b>GEV No.</b>  | 521104 | <b>Ref. No.</b> —                   |
|   | washer ID $\varnothing$ 4.3mm ED $\varnothing$ 8mm thickness 0.5mm brass Qty 20 pcs for thread M4             |        |                                     |
|  | <b>GEV No.</b>  | 560111 | <b>Ref. No.</b> 12009987<br>Q232020 |
|   | plain washer ID $\varnothing$ 4.3mm ED $\varnothing$ 9mm thickness 0.8mm SS Qty 20 pcs DIN 125A for thread M4 |        |                                     |
|  | <b>GEV No.</b>  | 560131 | <b>Ref. No.</b> 12009839<br>Q162020 |
|   | hexagonal nut thread M4 H 3.2mm WS 7 SS DIN/ISO DIN 934 / ISO 4032/8673 Qty 20 pcs                            |        |                                     |

## 2 hole fixing

## group 4

|  |   |                 |                     |
|--|---|-----------------|---------------------|
|  |   |                 |                     |
| <b>GEV No.</b>   | 420157  | <b>Ref. No.</b> | 12024661<br>J153007 |
| <b>description</b>   | heating element 2750W 230V heating circuits 1 L 298mm W 150mm L1 46mm L2 252mm W1 98mm W2 52mm thread 1/4" mounting distance 44mm tube $\varnothing$ 8mm connection length 22mm 2 hole fixing fryer heaters |                 |                     |
| <b>For models:</b>   | FE6-05, FE6-10  |                 |                     |



Зип-Общепит

vsezip.ru

+7(812)987-08-81

|                        |  |                 |                                  |
|------------------------|--|-----------------|----------------------------------|
|                        |  |                 |                                  |
| <b>GEV No.</b>         | 416603   | <b>Ref. No.</b> | X323001                          |
| <b>description</b>     | heating element 4000W 230V heating circuits 1 mounting pos. right + centre L 300mm W 85mm H 300mm L1 40mm L2 260mm W1 41mm W2 44mm H1 40mm H2 210mm H3 50mm mounting distance 35mm thread M14x1.25 tube ø 8.5mm 2 hole fixing connection M4 fryer connection length 27mm |                 |                                  |
| <b>accessories for</b> | 416603   |                 |                                  |
|                        | <b>GEV No.</b>   | 521103          | <b>Ref. No.</b> —                |
|                        | nut thread M4 H 3mm WS 7 brass Qty 20 pcs  |                 |                                  |
|                        | <b>GEV No.</b>   | 521104          | <b>Ref. No.</b> —                |
|                        | washer ID ø 4.3mm ED ø 8mm thickness 0.5mm brass Qty 20 pcs for thread M4  |                 |                                  |
|                        | <b>GEV No.</b>   | 528401          | <b>Ref. No.</b> —                |
|                        | flat gasket fibre ED ø 22mm ID ø 16mm thickness 2mm Qty 1 pcs  |                 |                                  |
|                        | <b>GEV No.</b>   | 560111          | <b>Ref. No.</b> 12009987 Q232020 |
|                        | plain washer ID ø 4.3mm ED ø 9mm thickness 0.8mm SS Qty 20 pcs DIN 125A for thread M4  |                 |                                  |
|                        | <b>GEV No.</b>   | 560131          | <b>Ref. No.</b> 12009839 Q162020 |
|                        | hexagonal nut thread M4 H 3.2mm WS 7 SS DIN/ISO DIN 934 / ISO 4032/8673 Qty 20 pcs   |                 |                                  |

|                |   |                 |                  |
|----------------|---|-----------------|------------------|
|                |   |                 |                  |
| <b>GEV No.</b> | 560111  | <b>Ref. No.</b> | 12009987 Q232020 |
|                | plain washer ID ø 4.3mm ED ø 9mm thickness 0.8mm SS Qty 20 pcs DIN 125A for thread M4 |                 |                  |
|                |   |                 |                  |
| <b>GEV No.</b> | 560131  | <b>Ref. No.</b> | 12009839 Q162020 |
|                | Hexagonal nut thread M4 H 3.2mm WS 7 SS DIN/ISO DIN 934 / ISO 4032/8673 Qty 20 pcs    |                 |                  |

|                        |  |                 |   |
|------------------------|--|-----------------|---|
|                        |  |                 |   |
| <b>GEV No.</b>         | 416548   | <b>Ref. No.</b> | 12024704  |
| <b>description</b>     | heating element 4000W 230V heating circuits 1 mounting pos. right + centre L 300mm W 85mm H 300mm L1 40mm L2 260mm W1 41mm W2 44mm H1 40mm H2 210mm H3 50mm mounting distance 36mm thread M14x1.25 tube ø 8mm 2 hole fixing connection M4 immersion heater connection length 27mm windings 6 fryer |                 |   |
| <b>For models:</b>     | FE7-05-1C, FE7-05-2C, FE7-10-2C, FE7-10-4C   |                 |   |
| <b>accessories for</b> | 416548   |                 |   |
|                        | <b>GEV No.</b>   | 401088          | <b>Ref. No.</b> 12020238 12024400 X323008 X323011 |
|                        | copper wire 2.5mm <sup>2</sup> insulation glass fibre connection cable lug ø4mm L 1400mm   |                 |   |
|                        | <b>GEV No.</b>   | 521103          | <b>Ref. No.</b> —                                 |
|                        | nut thread M4 H 3mm WS 7 brass Qty 20 pcs  |                 |   |
|                        | <b>GEV No.</b>   | 521104          | <b>Ref. No.</b> —                                 |
|                        | washer ID ø 4.3mm ED ø 8mm thickness 0.5mm brass Qty 20 pcs for thread M4  |                 |   |

|                        |   |                 |                                  |
|------------------------|---|-----------------|----------------------------------|
|                        |   |                 |                                  |
| <b>GEV No.</b>         | 416604  | <b>Ref. No.</b> | X323002 X323010                  |
| <b>description</b>     | heating element 4000W 230V heating circuits 1 mounting pos. left L 285mm W 85mm H 290mm L1 35mm L2 260mm W1 45mm W2 40mm H1 242mm H2 48mm H3 50mm mounting distance 26mm thread M14x1.25 tube ø 8mm 2 hole fixing cable length 1350mm connection M4 immersion heater connection length 26mm |                 |                                  |
| <b>accessories for</b> | 416604  |                 |                                  |
|                        | <b>GEV No.</b>  | 521103          | <b>Ref. No.</b> —                |
|                        | nut thread M4 H 3mm WS 7 brass Qty 20 pcs   |                 |                                  |
|                        | <b>GEV No.</b>  | 521104          | <b>Ref. No.</b> —                |
|                        | washer ID ø 4.3mm ED ø 8mm thickness 0.5mm brass Qty 20 pcs for thread M4   |                 |                                  |
|                        | <b>GEV No.</b>  | 528401          | <b>Ref. No.</b> —                |
|                        | flat gasket fibre ED ø 22mm ID ø 16mm thickness 2mm Qty 1 pcs   |                 |                                  |
|                        | <b>GEV No.</b>  | 560111          | <b>Ref. No.</b> 12009987 Q232020 |
|                        | plain washer ID ø 4.3mm ED ø 9mm thickness 0.8mm SS Qty 20 pcs DIN 125A for thread M4   |                 |                                  |
|                        | <b>GEV No.</b>  | 560131          | <b>Ref. No.</b> 12009839 Q162020 |
|                        | hexagonal nut thread M4 H 3.2mm WS 7 SS DIN/ISO DIN 934 / ISO 4032/8673 Qty 20 pcs  |                 |                                  |

electric components



Зип Общепит

vsezip.ru

+7(812)987-0808

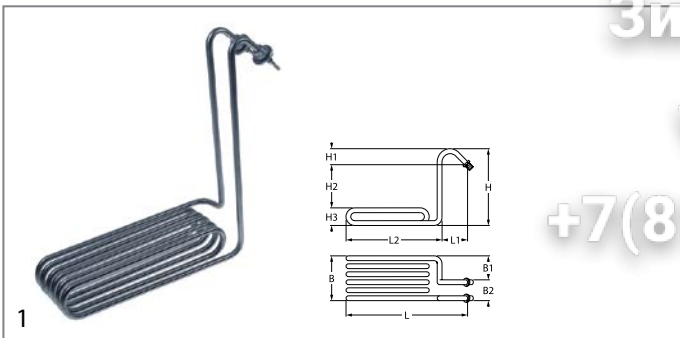

|                |        |                 |          |
|----------------|--------|-----------------|----------|
| <b>GEV No.</b> | 417166 | <b>Ref. No.</b> | 12024707 |
|----------------|--------|-----------------|----------|

**description** heating element 4000W 230V heating circuits 1 mounting pos. left L 295mm W 90mm H 290mm L1 35mm L2 260mm W1 45mm W2 45mm H1 35mm H2 207mm H3 48mm mounting distance 36mm thread M14x1.25 tube ø 8.5mm 2 hole fixing connection M4 immersion on heater connection length 38mm windings 6

**accessories for** 417166

|                |        |                 |  |
|----------------|--------|-----------------|--|
| <b>GEV No.</b> | 401088 | <b>Ref. No.</b> | 12020238<br>12024400<br>X323008<br>X323011 |
|----------------|--------|-----------------|--|

copper wire 2.5mm<sup>2</sup> insulation glass fibre connection cable lug ø4mm L 1400mm

|                |        |                 |   |
|----------------|--------|-----------------|---|
| <b>GEV No.</b> | 521103 | <b>Ref. No.</b> | — |
|----------------|--------|-----------------|---|

nut thread M4 H 3mm WS 7 brass Qty 20 pcs

|                |        |                 |   |
|----------------|--------|-----------------|---|
| <b>GEV No.</b> | 521104 | <b>Ref. No.</b> | — |
|----------------|--------|-----------------|---|

washer ID ø 4.3mm ED ø 8mm thickness 0.5mm brass Qty 20 pcs for thread M4

|                |        |                 |                     |
|----------------|--------|-----------------|---------------------|
| <b>GEV No.</b> | 560111 | <b>Ref. No.</b> | 12009987<br>Q232020 |
|----------------|--------|-----------------|---------------------|

plain washer ID ø 4.3mm ED ø 9mm thickness 0.8mm SS Qty 20 pcs DIN 125A for thread M4

|                |        |                 |                     |
|----------------|--------|-----------------|---------------------|
| <b>GEV No.</b> | 560131 | <b>Ref. No.</b> | 12009839<br>Q162020 |
|----------------|--------|-----------------|---------------------|

hexagonal nut thread M4 H 3.2mm WS 7 SS DIN/ISO DIN 934 / ISO 4032/8673 Qty 20 pcs

## group 10

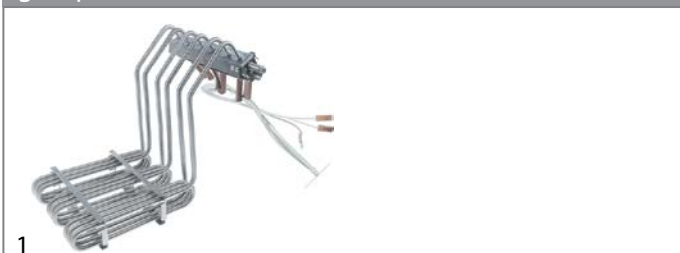

|                |        |                 |          |
|----------------|--------|-----------------|----------|
| <b>GEV No.</b> | 419112 | <b>Ref. No.</b> | 12004358 |
|----------------|--------|-----------------|----------|

**description** heating element 6000W 230V heating circuits 3 L 385mm W 200mm H 285mm cable length 1700mm tube ø 8.5mm

**For models:** FE6-05TE, FE6-10TE

## heating elements for griddles



|                |        |                 |                     |
|----------------|--------|-----------------|---------------------|
| <b>GEV No.</b> | 416602 | <b>Ref. No.</b> | 12024616<br>R893000 |
|----------------|--------|-----------------|---------------------|

**description** heating element 1500W 230V heating circuits 1 L 517mm W 87mm H 71mm tube ø 9mm connection M4 connection length 26mm connection distance 78mm dry heating element

**For models:** FTE7-05, FTE7-05L, FTE7-05R, FTE7-10, FTE7-10L, FTE7-10L+R, FTE7-10R, FTEC7-05L, FTEC7-10L

|                    |   |                 |                     |
|--------------------|---|-----------------|---------------------|
| <b>GEV No.</b>     | 416633  | <b>Ref. No.</b> | 12024626<br>R573010 |
| <b>description</b> | heating element 2000W 230V heating circuits 1 L 585mm W 100mm H 100mm tube ø 8mm connection M4 connection length 25mm connection distance 92mm dry heating element  |                 |                     |
| <b>For models:</b> | FTE9-05L, FTE9-05L-AD, FTE9-05PLUS-CL, FTE9-05PLUS-CR, FTE9-05PLUS-L, FTE9-05PLUS-R, FTE9-05R, FTE9-05R-AD, FTE9-10L, FTE9-10L+R, FTE9-10L+R-AD, FTE9-10L-AD, FTE9-10PLUS-CL, FTE9-10PLUS-CLR, FTE9-10PLUS-CR, FTE9-10PLUS-L, FTE9-10PLUS-LR, FTE9-10PLUS-R, FTE9-10R, FTE9-10R-AD, FTEC9-05L, FTEC9-05L-AD, FTEC9-05R, FTEC9-05R-AD, FTEC9-05USMC, FTEC9-10L, FTEC9-10L+R, FTEC9-10L+R-AD, FTEC9-10L-AD, FTEC9-10R, FTEC9-10R-AD, FTEC9-10USMC |                 |                     |

## heating elements for refrigeration

## heating elements for defrosting



|                |        |                 |  |
|----------------|--------|-----------------|--|
| <b>GEV No.</b> | 417221 | <b>Ref. No.</b> | 12034275<br>12034637<br>6001508021<br>6021250019 |
|----------------|--------|-----------------|--|

**description** heating element 350W 230V L 360mm W 114mm H 12mm cable length 1000mm tube ø 8.5mm defrosting connection with cable

**For models:** AF-1402-MIX, AF-1403-C, AF-1404-C, AF-1602-MIX, AF-1603-C, AF-1604-C, AF-2104-C, AF-2105-C, AF-2106-C, AF-702-C, AF-802-C, AFN-701, AFN-702, AFN-801, AFN-802, AFP-1402-MIX, AP-701, CAF-1402MIXT, CAF-1602MIX, CAF-802-P, CAFN-701, CAFN-702, CAFN-801, CAFN-802, CAP-701, CMFN-135, CMFN-180, CMPN-117-R, CMPN-150, CMPN-169-R, CMPN-202, CMSN-117-R, CMSN-150, CMSN-169-R, CMSN-200, MCN-102-GN-R, MCN-135-GN, MCN-147-GN-R, MCN-180-GN, MCN-192-GN-R, MCN-225-GN, MCN-237-GN-R, MCN-270-GN, MFN-102-GN-R, MFN-135-GN, MFN-147-GN-R, MFN-180-GN, MFN-192-GN-R, MFN-225-GN, MFN-237-GN-R...(Other models you can see in the webshop)



|                |        |                 |                        |
|----------------|--------|-----------------|------------------------|
| <b>GEV No.</b> | 417527 | <b>Ref. No.</b> | 12033938<br>6021250021 |
|----------------|--------|-----------------|------------------------|

**description** heating element 350W 230V L 380mm W 115mm H 12mm cable length 1000mm tube ø 8.5mm defrosting connection with cable

**For models:** CAF-1603-C, CAF-1604-C, CAF-702C, MCN-270-GN, MFN-135, MFN-180, MFN-225-GN, MFN-270-GN, MFP-225-GN, MFP-270-GN, MPN-255, MPN-255-C, MPN-274-R, MSN-150, MSN-200, MSN-250, MSN-300



|                |        |                 |  |
|----------------|--------|-----------------|--|
| <b>GEV No.</b> | 417223 | <b>Ref. No.</b> | 12034050<br>12037967<br>6001508024<br>6021250022 |
|----------------|--------|-----------------|--|

**description** heating element 650W 220V L 660mm W 180mm W1 65mm W2 115mm cable length 1000mm tube ø 8.5mm connection with cable

**For models:** AFN-1402, AFN-1403, AFN-1404, AFN-1602, AFN-1603, AFN-1604, CAFN-1402, CAFN-1403, CAFN-1404



heating elements for tilting bratt pan

Зип-Общепит

vsezip.ru

(812) 98-49-81



|                    |   |                 |                     |
|--------------------|---|-----------------|---------------------|
| <b>GEV No.</b>     | 416607  | <b>Ref. No.</b> | 12024620<br>X273000 |
| <b>description</b> | heating element 1500W 230V L 417mm W 95mm H 46mm connection M4 dry heating element heating circuits 1 tube ø 9mm connection distance 77mm |                 |                     |
| <b>For models:</b> | FTE6-05L, FTE6-05R, SBE7-10   |                 |                     |



|                    |   |                 |                        |
|--------------------|---|-----------------|------------------------|
| <b>GEV No.</b>     | 418801  | <b>Ref. No.</b> | 12032595<br>6021250023 |
| <b>description</b> | heating element dinner cart 1500W 230V L 390mm W 80mm H 35mm connection M5 thread M12x1 tube ø 8.5mm mounting distance 72mm |                 |                        |



|                    |  |                 |                     |
|--------------------|--|-----------------|---------------------|
| <b>GEV No.</b>     | 416615   | <b>Ref. No.</b> | 12018865<br>X143000 |
| <b>description</b> | heating element 2000W 230V L 523mm W 95mm H 81mm connection M4 dry heating element heating circuits 1 tube ø 8mm connection length 26mm connection distance 87mm |                 |                     |
| <b>For models:</b> | SBE9-10, SBE9-10I, SBE9-10IM   |                 |                     |

dry heating elements for dishwashers



|                    |  |                 |          |
|--------------------|--|-----------------|----------|
| <b>GEV No.</b>     | 420561   | <b>Ref. No.</b> | 12048965 |
| <b>description</b> | heating element 2800W 230V heating circuits 1 L 325mm W 55mm H 40mm tube ø 6.5mm connection F6.3x0.8 dry heating element dishwasher  |                 |          |
| <b>For models:</b> | CO-500, CO-500B, CO-500BDD, CO-500DD, CO-501, CO-501B, CO-501BDD, CO-501DD, CO-501-SOFT, CO-502B, CO-502BDD, CO-502DD, CO-502W, COP-503, COP-503B, COP-503BDD, COP-503DD, COP-503-SOFT, COP-504, COP-504B, COP-504BDD, COP-504DD, COP-504W |                 |          |



|                    |  |                 |                     |
|--------------------|--|-----------------|---------------------|
| <b>GEV No.</b>     | 416616   | <b>Ref. No.</b> | 12024617<br>X143010 |
| <b>description</b> | heating element 2000W 230V L 525mm W 82mm H 46mm connection M4 dry heating element heating circuits 1 tube ø 8.5mm connection distance 69mm  |                 |                     |
| <b>For models:</b> | SBE9-10, SBE9-10I, SBE9-10I-AD, SBE9-10I-AD-S, SBE9-10IM, SBE9-10IM-AD, SBE9-10IM-AD-S, SBE9-10IMS, SBE9-10IS, SBE9-10M, SBE9-10MS, SBE9-10PLUS-I, SBE9-10PLUS-IM, SBE9-10PLUS-SI, SBE9-10PLUS-SIM, SBE9-10S, SBE9-10USMC, SBE9-15IM, SBE9-15IM-AD, SBE9-15IM-AD-S, SBE9-15IMS, SBE9-15M, SBE9-15MS, SBE9-15PLUS-IM, SBE9-15PLUS-SIM |                 |                     |

heating cables

connection on both sides

with male fastons



|                    |  |                 |  |
|--------------------|--|-----------------|--|
| <b>GEV No.</b>     | 418807   | <b>Ref. No.</b> | 12035911<br>12036102<br>6001508011<br>6021250011 |
| <b>description</b> | heating cable 18W 230V L 4750mm silicone connection male faston 6.3mm  |                 |  |
| <b>For models:</b> | AF-1403-C, AF-1404-C, AF-1603-C, AF-1604-C, AF-2104-C, AF-2105-C, AF-2106-C, AF-702-C, AFN-1402, AFN-1403, AFN-1404, AFN-1602, AFN-1603, AFN-1604, AFN-701, AFN-702, AFN-801, AFN-802, AFP-1402-MIX, AFP-702, AP-701, CAF-1403C, CAF-1404C, CAF-1603-C, CAF-1604-C, CAF-2104P, CAF-2105P, CAF-2106P, CAF-702C, CAF-802-P, CMPN-117-R, CMPN-150, CMPN-169-R, CMPN-202, CMPN-222-R, CMPN-255, MCN-102-GN-R, MCN-135-GN, MCN-147-GN-R, MCN-180-GN, MCN-192-GN-R, MCN-225-GN, MCN-237-GN-R, MCN-270-GN, MFN-102-GN-R, MFN-135, MFN-135-GN, MFN-147-GN-R, MFN-180, MFN-180-GN...(Other models you can see in the webshop) |                 |  |

heating elements for pasta cookers



|                    |  |                 |                     |
|--------------------|--|-----------------|---------------------|
| <b>GEV No.</b>     | 418799   | <b>Ref. No.</b> | 12024715<br>H063002 |
| <b>description</b> | heating element 4000W 230V heating circuits 3 L 348mm W 65mm H 27mm expansion flange connection male faston 6.3mm tube ø 6.2mm pasta cooker flange 70x18mm |                 |                     |
| <b>For models:</b> | CPE7-05, CPE7-05NC, CPE9-05, CPE9-05AD, CPE9-05AD-S, CPE9-05NC, CPE9-05PLUS, CPE9-05PLUS-S, CPE9-05S, CPE9-05SNC, EPC-350                                  |                 |                     |



|                    |  |                 |  |
|--------------------|--|-----------------|--|
| <b>GEV No.</b>     | 418808   | <b>Ref. No.</b> | 12033714<br>12036313<br>6001508005<br>6021250005 |
| <b>description</b> | heating cable 20W 220V L 3450mm L1 (unheated) 2150mm L2 (heated) 1300mm silicone connection male faston 6.3mm  |                 |  |
| <b>For models:</b> | ADAFN-1602, ADAFN-801, ADMCN-135, ADMCN-180, ADMCN-225, ADMFN-135, ADMFN-180, ADMFN-225, AEP-1602, AEP-802, AF-1402-MIX, AF-1403-C, AF-1404-C, AF-1602-MIX, AF-1603-C, AF-1603-P, AF-1604-C, AF-1604-P, AF-2104-C, AF-2105-C, AF-2106-C, AF-702-P, AF-802-C, AFN-1402, AFN-1403, AFN-1404, AFN-1602, AFN-1603, AFN-1604, AFN-701, AFN-702, AFN-801, AFN-802, AFP-1402-MIX, AFP-1602, AFP-1603, AFP-1604, AFP-701, AFP-702, AFP-702-C, AFP-702-P, ANF-1602AD, ANF-1603AD, ANF-1604AD, ANF-801AD, ANF-802AD, AP-701, CAF-1402MIX, CAF-1602MIX, CAFN-1402...(Other models you can see in the webshop) |                 |  |

heating elements for heated trolleys





|                    |  |                 |                        |
|--------------------|--|-----------------|------------------------|
| <b>GEV No.</b>     | 418802   | <b>Ref. No.</b> | 12034205<br>6021250024 |
| <b>description</b> | heating element dinner cart 1000W 230V L 385mm W 80mm H 35mm connection M4 thread M12x1.25 tube ø 8mm mounting distance 71mm |                 |                        |

Зип Общепит

vsezip.ru

+7(812)987-08-81

|  |   |
|--|---|
|  |   |
| <b>GEV No.</b>   | 418806  |
| <b>Ref. No.</b>  | 12031355<br>12035540<br>6001508007<br>6021250007  |
| <b>description</b>   | heating cable 26W 230V L 6400mm silicone connection male faston 6.3mm   |
| <b>For models:</b>   | AEP-1402, AEP-1403, AEP-1404, AEP-1602, AEP-1603, AEP-1604, AF-1402-MIX, AF-1403-C, AF-1404-C, AF-1602-MIX, AF-1603-C, AF-1604-C, AFN-1402, AFN-1403, AFN-1404, AFN-1602, AFN-1603, AFN-1604, AFN-701, AFP-1402, AFP-1402-MIX, AFP-1403, AFP-1403-C, AFP-1403-FORZ, AFP-1403-P, AFP-1404, AFP-1404-C, AFP-1404-FORZ, AFP-1404-P, AFP-1602, AFP-1602-2, AFP-1603, AFP-1604, CAF-1403C, CAF-1404C, CAF-1603-C, CAF-1604-C, CAFN-1402, CAFN-1403, CAFN-1404, CAFN-1602, CAFN-1603, CAFN-1604 |

|  |  |
|--|--|
|  |  |
| <b>GEV No.</b>   | 418803   |
| <b>Ref. No.</b>  | 12035174<br>12035494<br>6001508015<br>6021250015   |
| <b>description</b>   | heating cable 60W 230V 50Hz L 7400mm silicone defrosting connection male faston 6.3mm                          |
| <b>For models:</b>   | AFP-2103, AFP-2104, AFP-2104-C, AFP-2104-P, AFP-2105, AFP-2105-C, AFP-2105-P, AFP-2106, AFP-2106-C, AFP-2106-P |

|  |  |
|--|--|
|  |  |
| <b>GEV No.</b>   | 418804   |
| <b>Ref. No.</b>  | 12032620<br>12036191<br>6001508010<br>6021250010   |
| <b>description</b>   | heating cable 31W 230V L 3200mm L1 (unheated) 2000mm L2 (heated) 1200mm silicone connection male faston 6.3mm mounting pos. vertical   |
| <b>For models:</b>   | AEP-1402, AEP-1403, AEP-1404, AEP-1602, AEP-1603, AEP-1604, AF-1402-MIX, AF-1403-C, AF-1404-C, AF-1602-MIX, AF-1603-C, AF-1604-C, AFN-1402, AFN-1403, AFN-1404, AFN-1602, AFN-1603, AFN-1604, AFN-701, AFP-1402, AFP-1402-MIX, AFP-1403, AFP-1403-C, AFP-1403-P, AFP-1404, AFP-1404-C, AFP-1404-P, AFP-1602, AFP-1602-2, AFP-1603, AFP-1604, AFP-2103, AFP-2104, AFP-2104-C, AFP-2104-P, AFP-2105, AFP-2105-C, AFP-2105-P, AFP-2106, AFP-2106-C, AFP-2106-P, ATM-101, CAF-1403C, CAF-1404C, CAF-1603-C, CAF-1604-C, CAFN-1402, CAFN-1403, CAFN-1404, CAFN-1602...(Other models you can see in the webshop) |

## heating plates

|  |  |
|--|--|
|  |  |
| <b>GEV No.</b>   | 420522   |
| <b>Ref. No.</b>  | 12024702<br>J303001000   |
| <b>description</b>   | hot plate 1600W 230V L 360mm W 110mm   |
| <b>For models:</b>   | BME6-05, CMF6-05, FTE6-05L, FTE6-05R, FTE6-10L, FTE6-10L+R, FTE6-10R, FTE6-05L, FTE6-10L, FTE6-10L+R |

|  |  |
|--|--|
|  |  |
| <b>GEV No.</b>   | 418809   |
| <b>Ref. No.</b>  | 12034144<br>12034613<br>6001508006<br>6021250006   |
| <b>description</b>   | heating cable 41W 220V L 6250mm L1 (unheated) 3550mm L2 (heated) 2700mm silicone connection male faston 6.3mm  |
| <b>For models:</b>   | AEP-1602, AEP-1603, AEP-1604, AEP-801, AEP-802, AF-1602-MIX, AF-1603-C, AF-1603-P, AF-1604-C, AF-1604-P, AF-802-C, AF-802-P, AFN-1402, AFN-1403, AFN-1404, AFN-1602, AFN-1603, AFN-1604, AFN-701, AFN-801, AFN-802, AFP-1402, AFP-1403, AFP-1403-C, AFP-1403-FORZ, AFP-1403-P, AFP-1404, AFP-1404-C, AFP-1404-FORZ, AFP-1404-P, AFP-1602, AFP-1602-2, AFP-1603, AFP-1603-2, AFP-1604, AFP-801, AFP-802, AFP-802-2, AP-701, APP-701, VM-100-I, VM-100-M, VM-135-I, VM-135-M |

## coil heating elements

|   |  |
|---|--|
|  |  |
| <b>GEV No.</b>  | 418969   |
| <b>Ref. No.</b>   | 12024856<br>Z276391  |
| <b>description</b>  | heating element 1500W 230V L 455mm W 50mm H 25mm tube ø 8mm thread M12x1.25 connection M4 heating circuits 1   |
| <b>For models:</b>  | ECO-160, ECO-160D, ECO-160I, ECO-200, ECO-200D, ECO-200H, ECO-200HD, ECO-200HI, ECO-200I, ECO-2700D, ECO-2700I, ECO-280D, ECO-280I, ECO-370D, ECO-370I, ECO-4000D, ECO-4000I, ECO-460D, ECO-460I, ECO-550D, ECO-550I, ECO-6000D, ECO-6000I, FI-160, FI-160AR, FI-160D, FI-160I, FI-200, FI-200AR, FI-200D, FI-200H, FI-200HD, FI-200HI, FI-200I, FI-200W, FI-200WL, FI-200WR, FI-2700D, FI-2700I, FI-280D, FI-280I, FI-370D, FI-370I, FI-4000D, FI-4000I, FI-460D, FI-460I, FI-550D, FI-550I, FI-6000D...(Other models you can see in the webshop) |

|  |  |
|--|--|
|  |  |
| <b>GEV No.</b>   | 418805   |
| <b>Ref. No.</b>  | 12032324<br>12036014<br>6001508009<br>6021250009   |
| <b>description</b>   | heating cable 43W 230V L 5000mm silicone connection male faston 6.3mm  |
| <b>For models:</b>   | ADAEP-801, ADAFN-1602, ADAFN-801, ADAFP-801, AEP-701, AEP-702, AEP-801, AEP-802, AF-1402-MIX, AF-1403-C, AF-1404-C, AF-1602-MIX, AF-702-C, AF-702-P, AF-802-C, AFN-1402, AFN-701, AFN-702, AFN-801, AFN-802, AFP-1402-FORZ, AFP-1402-MIX, AFP-1403-FORZ, AFP-2103, AFP-2104, AFP-2104-C, AFP-2104-P, AFP-2105, AFP-2105-C, AFP-2105-P, AFP-2106, AFP-2106-C, AFP-2106-P, AFP-701, AFP-702, AFP-702-C, AFP-702-FORZ, AFP-702-P, AFP-801, AFP-802, AFP-802-2, ANF-1602AD, ANF-1603AD, ANF-1604AD, ANF-801AD, ANF-802AD, CAF-1402MIXT, CAF-1602MIX, CAF-702C, CAF-802-P...(Other models you can see in the webshop) |





immersion heating elements

Зип Общежит

3 hole flange ø57.5mm

3 hole flange ø57.5mm

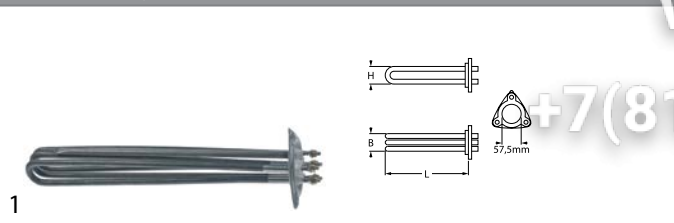

|                |        |                 |                     |
|----------------|--------|-----------------|---------------------|
| <b>GEV No.</b> | 415021 | <b>Ref. No.</b> | 12024713<br>Z313601 |
|----------------|--------|-----------------|---------------------|

**description** heating element 6000W 230V mounting ø 57.5mm heating circuits 3 L 343mm W 37mm H 50mm number of thermostat sleeves 1 thermostat sleeves ø 7mm length thermostat sleeves 294mm thermostat sleeve not clinging tube ø 8.5mm hole distance 72mm hole ø 8mm connection M5 3 hole flange

**For models:** ECO-2700D, ECO-2700I, ECO-280D, ECO-280I, ECO-370D, ECO-370I, ECO-4000D, ECO-4000I, ECO-460D, ECO-460I, ECO-550D, ECO-550I, ECO-6000D, ECO-6000I, FI-2700D, FI-2700I, FI-280D, FI-280I, FI-370D, FI-370I, FI-4000D, FI-4000I, FI-460D, FI-460I, FI-550D, FI-550I, FI-6000D, FI-6000I

**spare parts for** 415021

|   |                |        |                 |                     |
|---|----------------|--------|-----------------|---------------------|
|   | <b>GEV No.</b> | 510409 | <b>Ref. No.</b> | 12010040<br>Q307044 |
| O-ring EPDM thickness 5.34mm ID ø 56.52mm Qty 1 pcs |                |        |                 |                     |

**accessories for** 415021

|   |                |        |                 |   |
|---|----------------|--------|-----------------|---|
|   | <b>GEV No.</b> | 550002 | <b>Ref. No.</b> | — |
| tension strap H 10mm L 21mm W 10mm hole ø 6.5mm for heating element |                |        |                 |   |

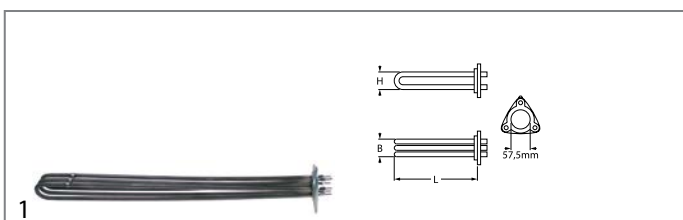

|                |        |                 |  |
|----------------|--------|-----------------|--|
| <b>GEV No.</b> | 418798 | <b>Ref. No.</b> | 12024214<br>12040415<br>Z121740<br>Z121741 |
|----------------|--------|-----------------|--|

**description** heating element 9600W 230V mounting ø 57.5mm heating circuits 3 L 545mm W 36mm H 53mm number of thermostat sleeves 1 thermostat sleeves ø 7mm length thermostat sleeves 190mm tube ø 8mm hole distance 73mm hole ø 8mm connection M4

**For models:** ECO-160, ECO-1600, ECO-160D, ECO-160I, ECO-200, ECO-200D, ECO-200H, ECO-200HD, ECO-200HI, ECO-200I, ECO-2300, ECO-2700D, ECO-2700I, ECO-3000, ECO-4000D, ECO-4000I, ECO-6000D, ECO-6000I, FI-160, FI-1600, FI-160AR, FI-160D, FI-160I, FI-200, FI-200AR, FI-200D, FI-200H, FI-200HD, FI-200HI, FI-200I, FI-200WL, FI-200WR, FI-2300, FI-2700D, FI-2700I, FI-280D, FI-280I, FI-3000, FI-370D, FI-370I, FI-4000D, FI-4000I, FI-460D, FI-460I, FI-550D, FI-550I, FI-6000D, FI-6000I

**accessories for** 418798

|   |                |        |                 |                     |
|---|----------------|--------|-----------------|---------------------|
|   | <b>GEV No.</b> | 510409 | <b>Ref. No.</b> | 12010040<br>Q307044 |
| O-ring EPDM thickness 5.34mm ID ø 56.52mm Qty 1 pcs |                |        |                 |                     |

connection straight

vsezip.ru



|                |        |                 |                     |
|----------------|--------|-----------------|---------------------|
| <b>GEV No.</b> | 420325 | <b>Ref. No.</b> | 12024721<br>Z129502 |
|----------------|--------|-----------------|---------------------|

**description** heating element 12000W 230V mounting ø 60mm heating circuits 3 L 545mm W 36mm H 41mm number of thermostat sleeves 1 thermostat sleeves ø 7mm length thermostat sleeves 175mm thermostat sleeve eccentric, non clinging tube ø 8.5mm hole distance 73mm hole ø 10mm connection M4 3 hole flange immersion heater

**For models:** ECO-6000D, ECO-6000I, FI-160D, FI-160I, FI-200AR, FI-200D, FI-200HD, FI-200HI, FI-200I, FI-200W, FI-2700D, FI-2700I, FI-4000D, FI-4000I, FI-460D, FI-460I, FI-550D, FI-550I, FI-6000D, FI-6000I



|                |        |                 |                                |
|----------------|--------|-----------------|--------------------------------|
| <b>GEV No.</b> | 420324 | <b>Ref. No.</b> | 12024740<br>Z101720<br>Z101740 |
|----------------|--------|-----------------|--------------------------------|

**description** heating element 6000W 230V mounting ø 60mm heating circuits 3 L 545mm W 36mm H 41mm number of thermostat sleeves 1 thermostat sleeves ø 7mm length thermostat sleeves 175mm thermostat sleeve eccentric, non clinging tube ø 8.5mm hole distance 73mm hole ø 10mm connection M4 3 hole flange immersion heater

**For models:** ECO-1600, ECO-2300, ECO-280D, ECO-280I, ECO-3000, ECO-370D, ECO-370I, ECO-460D, ECO-460I, ECO-550D, ECO-550I, FI-1600, FI-2300, FI-280D, FI-280I, FI-3000, FI-370D, FI-370I, FI-460D, FI-460I, FI-550D, FI-550I

with expansion flange 70 x 18mm



|                |        |                 |                     |
|----------------|--------|-----------------|---------------------|
| <b>GEV No.</b> | 416380 | <b>Ref. No.</b> | 12024986<br>Z733601 |
|----------------|--------|-----------------|---------------------|

**description** heating element 1000W 230V heating circuits 1 flange 70x18mm L 273mm W 63mm H 27mm connection M4 immersion heater expansion flange tube ø 6.5mm



**For models:** ECO-120, LVC-12, LVC-15, LVC-21, LVR-10

**accessories for** 416380

|   |                |        |                 |   |
|---|----------------|--------|-----------------|---|
|   | <b>GEV No.</b> | 510429 | <b>Ref. No.</b> | — |
| gasket L 76mm W 23mm hole distance 25mm 3 holes for heating element type DB 70 without thermostat sensor hole |                |        |                 |   |





Зип Общепит  
vsezip.ru  
+7(812)9810818

|   |  |                 |                     |
|---|--|-----------------|---------------------|
|  |  |                 |                     |
| <b>GEV No.</b>  | 416381   | <b>Ref. No.</b> | 12024951<br>R222005 |
| <b>description</b>  | heating element 2000W 230V heating circuits 1 flange 70x18mm L 280mm W 78mm H 22mm connection M4 immersion heater expansion flange tube ø 8.5mm  |                 |                     |
| <b>For models:</b>  | AD-15, AD-15D, AD-20C-UK, AD-21, AD-21B, AD-21BDD, AD-21C, AD-21D, AD-21DD, AD-21W, AD-45BBT, BME7-05, BME7-10, BME9-10, BME9-10AD, BME9-10PLUS, BME9-10V-T, FI-30, FI-30AR, FI-30AR+DD, FI-30B-BT-UK, FI-30-UK, LVC-12, LVC-15, LVC-15D, LVC-21, LVC-21B, LVC-21C, LVC-21D, LVC-21W, LVR-14, LVR-14D, LVR-20, LVR-20B, LVR-20D, MF-21 |                 |                     |
| <b>accessories for</b>  | 416381   |                 |                     |
|  | <b>GEV No.</b>   | 510429          | <b>Ref. No.</b> —   |
|   | gasket L 76mm W 23mm hole distance 25mm 3 holes for heating element type DB 70 without thermostat sensor hole  |                 |                     |

|   |  |                 |                     |
|---|--|-----------------|---------------------|
|  |  |                 |                     |
| <b>GEV No.</b>  | 416382   | <b>Ref. No.</b> | 12024645<br>Z203601 |
| <b>description</b>  | heating element 2800W 230V heating circuits 1 flange 70x18mm L 370mm W 102mm H 27mm immersion heater tube ø 8.5mm  |                 |                     |
| <b>For models:</b>  | AD-48, AD-48B, AD-48BDD, AD-48C, AD-48D, AD-48DD, AD-48HY, AD-48W, AD-64, AD-64B, AD-64BBT, AD-64BDD, AD-64BTDD, AD-64C, AD-64CW, AD-64D, AD-64DD, AD-64HY, AD-72, AD-72W, BME9-05, BME9-05AD, BME9-05PLUS, BME9-05V-T, EASY-500, EASY-500B, EASY-500DD, EASY-500HP, EASY-500HPWBDD, ECO-120, ECO-120B, FI-100, FI-120, FI-120W, FI-30, FI-30AR, FI-30AR+DD, FI-30B, FI-30-UK, FI-48, FI-48AR, FI-48B, FI-48B-BT-UK, FI-48C, FI-48D, FI-48HY-CLINIC, FI-48W, FI-50, FI-60DD, FI-64...(Other models you can see in the webshop) |                 |                     |

|   |  |                 |                                 |
|---|--|-----------------|---------------------------------|
|  |  |                 |                                 |
| <b>GEV No.</b>  | 418800   | <b>Ref. No.</b> | 12024577<br>12041359<br>P533001 |
| <b>description</b>  | heating element 2x3000W 230V heating circuits 2 flange 70x18mm L 510mm W 60mm connection M4 tube ø 8mm expansion flange  |                 |                                 |
| <b>For models:</b>  | LA-25M, LA-AC-25M, LA-AC-25MA, LA-AC-25MP, LAC-25, LAC-25MP, LAC-25MPP, LAC-55, LAC-55MP, LAC-55MPP, LA-E-25M, LA-E-25MA, LA-E-25MP, LC-25, LC-E-25, LF-25MPP, LF-E-25, LF-E-25MP, LF-E-25MPP, LF-E-55, LF-E-55MP, LF-E-55MPP, LR-AC-25M, LR-AC-25MA, LR-AC-25MP, LR-E-25M, LR-E-25MA, LR-E-25MP |                 |                                 |

|   |   |                 |                     |
|---|---|-----------------|---------------------|
|  |   |                 |                     |
| <b>GEV No.</b>  | 418832  | <b>Ref. No.</b> | 12018752<br>P143002 |
| <b>description</b>  | heating element 3000W 230V heating circuits 1 flange 70x18mm L 350mm W 63mm connection M4 tube ø 8mm immersion heater |                 |                     |
| <b>For models:</b>  | LAC-10, LAC-10MP, LAC-10MPP, LC-10, LC-E-10, LC-E-10A, LF-E-10, LF-E-10A, LF-E-10MP, LF-E-10MPP                       |                 |                     |

|  |  |                 |                     |
|--|--|-----------------|---------------------|
|  |  |                 |                     |
| <b>GEV No.</b>   | 418885   | <b>Ref. No.</b> | 12023242<br>P633002 |
| <b>description</b>   | heating element 4000W 230V heating circuits 1 flange 70x18mm L 350mm W 63mm H 18mm L1 23mm L2 19mm L3 308mm tube ø 8mm connection M4 immersion heater connection length 37mm expansion flange EPDM |                 |                     |
| <b>For models:</b>   | LA-18MP, LA-AC-18M, LA-AC-18MA, LA-AC-18MP, LA-E-18M, LA-E-18MA, LA-E-18MP, LF-18MPP, LR-AC-18M, LR-AC-18MA, LR-E-18M, LR-E-18MA, LR-E-18MP  |                 |                     |

|  |   |                 |                     |
|--|---|-----------------|---------------------|
|  |   |                 |                     |
| <b>GEV No.</b>   | 417236  | <b>Ref. No.</b> | 12017885<br>R673003 |
| <b>description</b>   | heating element 4200W 230V heating circuits 2 flange 70x18mm L 395mm W 70mm connection male faston 6.3mm tube ø 8mm expansion flange  |                 |                     |
| <b>For models:</b>   | HME-10-11, HME-10-21, HME-2-10-11, HME-6-11, HMM-10-11, HMM-10-21, HMM-2-10-11, HMM-6-11, HMP-10-11, HMP-10-21, HMP-2-10-11, HMP-6-11 |                 |                     |

|  |  |                 |                     |
|--|--|-----------------|---------------------|
|  |  |                 |                     |
| <b>GEV No.</b>   | 418529   | <b>Ref. No.</b> | 12023778<br>Z743601 |
| <b>description</b>   | heating element 4500W 230V heating circuits 3 flange 70x18mm L 365mm W 65mm H 27mm connection male faston 6.3mm immersion heater expansion flange tube ø 6.7mm   |                 |                     |
| <b>For models:</b>   | AD-120, AD-120B, AD-120BBTDD-UK, AD-120C, AD-120CW, AD-120HY, AD-90, AD-90BA, AD-90BBT, AD-90BDD, AD-90DD, ADE-120, ADE-120B, ECO-120, ECO-120B, FI-100, FI-100AR, FI-100B, FI-100BBT-UK, FI-120, FI-120AR+DD, FI-120B, FI-120C, FI-120HY-CLINIC, FI-120W, FI-80, FI-80AR, FI-80BBT-UK, FI-80W, FI-E-100, MF-120 |                 |                     |

with round flange (miscellaneous)

|  |  |                 |                        |
|--|--|-----------------|------------------------|
|  |  |                 |                        |
| <b>GEV No.</b>   | 419284   | <b>Ref. No.</b> | 12024718<br>Z201708000 |
| <b>description</b>   | heating element 2200W 230V mounting ø 62mm L 422mm W 39mm H 39mm heating circuits 1 flange ø 98mm mounting thread M4 flange tube ø 8.5mm thermostat sleeves ø 7.5mm number of thermostat sleeves 1 length thermostat sleeves 193mm thermostat sleeve centre not clinging |                 |                        |



Зип Общепит  
vsezip.ru  
8(812)987-0983

|                    |   |                 |                     |
|--------------------|---|-----------------|---------------------|
| miscellaneous      |   |                 |                     |
|                    |   |                 |                     |
| 1                  |   |                 |                     |
| <b>GEV No.</b>     | 416386  | <b>Ref. No.</b> | 12024145<br>Z428305 |
| <b>description</b> | heating element 12000W 230V mounting $\varnothing$ 60mm heating circuits 3 L 428mm W 45mm H 44mm thermostat sleeves $\varnothing$ 6.7mm length thermostat sleeves 250mm number of thermostat sleeves 1 thermostat sleeve not clinging tube $\varnothing$ 6.3mm hole distance 82mm hole $\varnothing$ 7mm connection M4 immersion heater 6 hole flange |                 |                     |
| <b>For models:</b> | AD-120, AD-120B, AD-120C, AD-120HY, CO-110, CO-110B, CO-110BDD, CO-110DD, CO-170, CO-170B, CO-170BDD, CO-170DD, CO-170HRS, CO-170HRSDD, CO-170HRS-SOFT, CO-170-SOFT, CO-172, CO-172B, CO-172BDD, CO-172DD, ECO-120, ECO-120B, FI-120, FI-120AR+DD, FI-120B, FI-120C, FI-120HY-CLINIC, FI-120W, LABP-1200, MF-120                                      |                 |                     |

|                    |  |                 |                       |
|--------------------|--|-----------------|-----------------------|
|                    |  |                 |                       |
| 1                  |  |                 |                       |
| <b>GEV No.</b>     | 417678   | <b>Ref. No.</b> | 12026917<br>RT4400195 |
| <b>description</b> | heating element 18000W 230V heating circuits 6 L 194mm W 87mm H 68mm hole distance 50mm hole $\varnothing$ 8mm number of thermostat sleeves 2 thermostat sleeves $\varnothing$ 6/2mm length thermostat sleeves 142/105mm thermostat sleeve clinging cable length 730mm immersion heater 10 hole flange |                 |                       |

|                        |  |                 |  |
|------------------------|--|-----------------|--|
|                        |  |                 |  |
| 1                      |  |                 |  |
| <b>GEV No.</b>         | 416383   | <b>Ref. No.</b> | 12017951<br>12024559<br>Z401711<br>Z401738 |
| <b>description</b>     | heating element 2400W 230V heating circuits 1 mounting $\varnothing$ 42mm L 278mm W 39mm H 39mm hole distance 64mm hole $\varnothing$ 7mm connection M4 immersion heater 5 hole flange |                 |  |
| <b>For models:</b>     | AD-15, AD-15D, LVC-12, LVC-15, LVC-15D, LVC-21D, LVR-10, LVR-14, LVR-14D   |                 |  |
| <b>accessories for</b> | 416383   |                 |  |
|                        | <b>GEV No.</b>   | 505092          | <b>Ref. No.</b>                            |
|                        |  |                 | 12010062<br>12016701<br>Q307053<br>S312113 |
|                        | O-ring EPDM thickness 5.34mm ID $\varnothing$ 43.82mm Qty 1 pcs  |                 |  |

|                        |   |                 |  |
|------------------------|---|-----------------|--|
|                        |   |                 |  |
| 1                      |   |                 |  |
| <b>GEV No.</b>         | 416387  | <b>Ref. No.</b> | 12017952<br>Z421711                        |
| <b>description</b>     | heating element 2800W 230V heating circuits 1 mounting $\varnothing$ 42mm L 275mm W 38mm H 38mm tube $\varnothing$ 8mm hole distance 74mm hole $\varnothing$ 7mm connection M4 immersion heater 5 hole flange |                 |  |
| <b>For models:</b>     | LVC-21, LVC-21B, LVC-21D, LVC-21W, LVR-20, LVR-20B, LVR-20D, MF-21  |                 |  |
| <b>accessories for</b> | 416387  |                 |  |
|                        | <b>GEV No.</b>  | 505092          | <b>Ref. No.</b>                            |
|                        |   |                 | 12010062<br>12016701<br>Q307053<br>S312113 |
|                        | O-ring EPDM thickness 5.34mm ID $\varnothing$ 43.82mm Qty 1 pcs   |                 |  |

|                        |  |                 |  |
|------------------------|--|-----------------|--|
|                        |  |                 |  |
| 1                      |  |                 |  |
| <b>GEV No.</b>         | 416375   | <b>Ref. No.</b> | 12024907<br>Z421712                        |
| <b>description</b>     | heating element 2800W 230V heating circuits 1 mounting $\varnothing$ 42mm L 290mm W 37mm H 52mm tube $\varnothing$ 8mm hole distance 42mm hole $\varnothing$ 7mm connection M4 5 hole flange |                 |  |
| <b>For models:</b>     | AD-21, AD-21B, AD-21BDD, AD-21C, AD-21D, AD-21DD, AD-21W, LVC-15D, LVC-21, LVC-21B, LVC-21C, LVC-21D, LVC-21W  |                 |  |
| <b>accessories for</b> | 416375   |                 |  |
|                        | <b>GEV No.</b>   | 505092          | <b>Ref. No.</b>                            |
|                        |  |                 | 12010062<br>12016701<br>Q307053<br>S312113 |
|                        | O-ring EPDM thickness 5.34mm ID $\varnothing$ 43.82mm Qty 1 pcs  |                 |  |
|                        | <b>GEV No.</b>   | 524478          | <b>Ref. No.</b>                            |
|                        |  |                 | —  |
|                        | O-ring Viton thickness 5.7mm ID $\varnothing$ 44.2mm Qty 1 pcs   |                 |  |

|                        |   |                 |                     |
|------------------------|---|-----------------|---------------------|
|                        |   |                 |                     |
| 1                      |   |                 |                     |
| <b>GEV No.</b>         | 416384  | <b>Ref. No.</b> | 12024683<br>Z201706 |
| <b>description</b>     | heating element 2800W 230V mounting $\varnothing$ 63mm heating circuits 1 L 427mm W 44mm H 43mm thermostat sleeves $\varnothing$ 6.5mm length thermostat sleeves 190mm number of thermostat sleeves 1 thermostat sleeve not clinging hole distance 41mm hole $\varnothing$ 7.5mm connection M4 3 hole flange round flange |                 |                     |
| <b>For models:</b>     | AD-48, AD-48B, AD-48BDD, AD-48C, AD-48D, AD-48DD, AD-48HY, EASY-500, EASY-500B, EASY-500DD, FI-30, FI-30AR, FI-30AR+DD, FI-30B, FI-48, FI-48AR, FI-48B, FI-48B-BT-UK, FI-48C, FI-48D, FI-48HY-CLINIC, FI-48W, FI-50, FI-64W   |                 |                     |
| <b>accessories for</b> | 416384  |                 |                     |
|                        | <b>GEV No.</b>  | 691033          | <b>Ref. No.</b>     |
|                        |   |                 | 12010051<br>Q307035 |
|                        | O-ring EPDM thickness 5.34mm ID $\varnothing$ 62.87mm Qty 1 pcs   |                 |                     |

|                        |   |                 |                     |
|------------------------|---|-----------------|---------------------|
|                        |   |                 |                     |
| 1                      |   |                 |                     |
| <b>GEV No.</b>         | 416385  | <b>Ref. No.</b> | 12024732<br>Z241701 |
| <b>description</b>     | heating element 6000W 230V mounting $\varnothing$ 63mm heating circuits 3 L 420mm W 39mm H 49mm thermostat sleeves $\varnothing$ 6.3mm length thermostat sleeves 190mm number of thermostat sleeves 1 thermostat sleeve not clinging tube $\varnothing$ 8mm hole distance 41mm hole $\varnothing$ 7mm connection M4 immersion heater 6 hole flange  |                 |                     |
| <b>For models:</b>     | AD-120BTD, AD-120BTD-UK, AD-45B, AD-64, AD-64B, AD-64B, AD-64B, AD-64BDD, AD-64BDD, AD-64C, AD-64D, AD-64D, AD-64D, AD-64HY, AD-72, AD-90, AD-90A, AD-90B, AD-90B, AD-90B, AD-90DD, CO-110, CO-110B, CO-110BDD, CO-110DD, CO-112, CO-112B, CO-112BDD, CO-112DD, EASY-500HP, EASY-500HPWBDD, FI-100, FI-48D, FI-60DD, FI-64, FI-64AR, FI-64B, FI-64B-BT-UK, FI-64C, FI-64D, FI-64HY-CLINIC, FI-64W, FI-72, FI-72AR, FI-80, FI-80AR, FI-80B, FI-80B, FI-80W, FI-900, LABP-800, MF-48, MF-64 |                 |                     |
| <b>accessories for</b> | 416385  |                 |                     |
|                        | <b>GEV No.</b>  | 691033          | <b>Ref. No.</b>     |
|                        |   |                 | 12010051<br>Q307035 |
|                        | O-ring EPDM thickness 5.34mm ID $\varnothing$ 62.87mm Qty 1 pcs   |                 |                     |

1 electric components





|                    |   |                 |                     |
|--------------------|---|-----------------|---------------------|
| <b>GEV No.</b>     | 420326  | <b>Ref. No.</b> | 12017495<br>Z691751 |
| <b>description</b> | heating element 9000W 220V mounting $\varnothing$ 63mm heating circuits 3 L 454mm W 48mm H 38mm thermostat sleeves $\varnothing$ 7mm length thermostat sleeves 180mm number of thermostat sleeves 1 thermostat sleeve centre not clinging tube $\varnothing$ 8mm hole distance 41mm hole $\varnothing$ 7mm connection M4 immersion heater 6 hole flange |                 |                     |
| <b>For models:</b> | FI-1200, ME9-10BM, ME9-15BM   |                 |                     |



|                    |   |                 |                       |
|--------------------|---|-----------------|-----------------------|
| <b>GEV No.</b>     | 417694  | <b>Ref. No.</b> | 12029395<br>RT4400194 |
| <b>description</b> | heating element 9000W 230V heating circuits 3 L 192mm W 39mm H 68mm hole distance 90mm hole $\varnothing$ 8mm thermostat sleeves $\varnothing$ 2.5/6.5mm length thermostat sleeves 155mm number of thermostat sleeves 2 thermostat sleeve eccentric, clinging flange length 82mm flange width 82mm tube $\varnothing$ 6.5mm cable length 200mm immersion heater 5 hole flange |                 |                       |



|   |   |                 |  |
|---|---|-----------------|--|
| <b>GEV No.</b>  | 417695  | <b>Ref. No.</b> | 12027948<br>12029916<br>RT32011004<br>RT32011009 |
| <b>description</b>  | heating element 9000W 230V heating circuits 3 L 205mm W 38mm H 70mm number of thermostat sleeves 1 thermostat sleeves $\varnothing$ 2.5mm length thermostat sleeves 120mm thermostat sleeve eccentric, clinging tube $\varnothing$ 6.3mm hole distance 64mm hole $\varnothing$ 8mm connection male faston 6.3mm 4 hole flange immersion heater flange width 82mm flange length 82mm |                 |  |
| <b>accessories for</b>  | 417695  |                 |  |
|  | <b>GEV No.</b>  | <b>Ref. No.</b> | 12036210<br>RT51101003                           |
|   | gasket rubber L 82mm W 82mm thickness 4mm hole $\varnothing$ 9mm hole distance 64mm for heating element suitable for RATIONAL 4 holes   |                 |  |





|   |   |                 |                     |
|---|---|-----------------|---------------------|
| <b>GEV No.</b>  | 420362  | <b>Ref. No.</b> | 12024747            |
| <b>description</b>  | heating element 9000W 230V heating circuits 3 L 280mm W 77mm H 29mm flange hole distance 47.5mm hole $\varnothing$ 6mm connection male faston 6.3mm tube $\varnothing$ 8.5mm flange length 105mm flange width 60mm immersion heater   |                 |                     |
| <b>For models:</b>  | ACE-102, AE-101, AE-101W, AE-102, AE-102W, AE-201, AE-202, APE-101, APE-101W, APE-102, APE-102W, APE-201, APE-202, HEP-10-21, HEP-20-21, ME9-10BM, ME9-10BMS, ME9-15BM, ME9-15BM316, ME9-15BMS, MPE9-10BM, MPE9-10BMS, MPE9-15BM, MPE9-15BMS, VE-102, VE-201, VE-202, VPE-102, VPE-201, VPE-202 |                 |                     |
| <b>accessories for</b>  | 420362  |                 |                     |
|  | <b>GEV No.</b>  | <b>Ref. No.</b> | 12023680<br>T323007 |
|   | gasket L 105mm W 60mm thickness 3mm for heating element   |                 |                     |

Зип Общепит

vsezip.ru

8(12)987-08-81



|   |   |                 |                     |
|---|---|-----------------|---------------------|
| <b>GEV No.</b>  | 417197  | <b>Ref. No.</b> | 12024752<br>T323006 |
| <b>description</b>  | heating element 9000W 230V heating circuits 3 L 280mm W 78mm H 35mm hole distance 48mm hole $\varnothing$ 6mm tube $\varnothing$ 8.5mm flange length 105mm flange width 60mm immersion heater thermostat sleeves $\varnothing$ 3mm number of thermostat sleeves 1 length thermostat sleeves 115mm |                 |                     |
| <b>For models:</b>  | ACE-061, ACE-102, AE-061, AE-061W, AE-101, AE-101W, AE-102, AE-102W, AE-201, AE-202, APE-061, APE-061W, APE-101, APE-101W, APE-102, APE-102W, APE-201, APE-202, HEM-10-21, HEM-20-21, HEP-10-21, HEP-20-21, VE-102, VE-201, VE-202, VPE-102, VPE-201, VPE-202                                     |                 |                     |
| <b>accessories for</b>  | 417197  |                 |                     |
|  | <b>GEV No.</b>  | <b>Ref. No.</b> | 12023680<br>T323007 |
|   | gasket L 105mm W 60mm thickness 3mm for heating element   |                 |                     |



|   |   |                 |                     |
|---|---|-----------------|---------------------|
| <b>GEV No.</b>  | 416606  | <b>Ref. No.</b> | 12023494<br>R143000 |
| <b>description</b>  | heating element 9000W 230V heating circuits 3 L 380mm W 75mm H 28mm rectangular flange hole distance 100mm hole $\varnothing$ 5mm connection male faston 6.3mm tube $\varnothing$ 8.1mm flange length 105mm flange width 60mm immersion heater since year of construction 2011  |                 |                     |
| <b>For models:</b>  | HEM-10-11, HEM-20-11, HEM-6-11, HEP-10-11, HEP-20-11, HEP-6-11, HME-10-11, HME-10-21, HME-20-11, HME-20-21, HME-2-10-11, HME-2-20-11, HME-6-11, HMM-10-11, HMM-10-11UL, HMM-10-21, HMM-10-21UL, HMM-20-11, HMM-20-11UL, HMM-20-21, HMM-20-21UL, HMM-2-10-11, HMM-2-20-11, HMM-40-11-USMC, HMM-6-11, HMM-6-11UL, HMP-10-11, HMP-10-21, HMP-20-11, HMP-20-21, HMP-2-10-11, HMP-2-20-11, HMP-6-11, ME7-10BM, ME9-10BM, ME9-10BMS, ME9-15BM, ME9-15BM316, ME9-15BMS, MPE9-10BM, MPE9-10BMS, MPE9-15BM, MPE9-15BMS, VE-101, VE-201, VPE-101, VPE-201 |                 |                     |
| <b>accessories for</b>  | 416606  |                 |                     |
|  | <b>GEV No.</b>  | <b>Ref. No.</b> | 12007832<br>R145012 |
|   | gasket L 105mm W 55mm thickness 5mm for heating element suitable for FAGOR equiv. no. R145012   |                 |                     |







|   |   |                 |                        |
|---|---|-----------------|------------------------|
| <b>GEV No.</b>  | 417711  | <b>Ref. No.</b> | 12029915<br>RT32011006 |
| <b>description</b>  | heating element 9000W 255V heating circuits 3 L 204mm W 38mm H 75mm number of thermostat sleeves 1 thermostat sleeves $\varnothing$ 3mm length thermostat sleeves 102mm thermostat sleeve eccentric, clinging tube $\varnothing$ 6.5mm hole distance 65mm hole $\varnothing$ 8mm connection length 38mm connection male faston 6.3mm rectangular flange immersion heater flange width 82mm flange length 82mm |                 |                        |
| <b>spare parts for</b>  | 417711  |                 |                        |
|  | <b>GEV No.</b>  | <b>Ref. No.</b> | 12036965<br>RT4400280  |
|   | gasket L 81mm W 81mm hole distance 65mm thickness 4mm for heating element suitable for RATIONAL equiv. no. 4400280  |                 |                        |





Зип Общепит heating elements for convection







vsezip.ru  
8(495)987-08-81

|   |   |                 |                                     |
|---|---|-----------------|-------------------------------------|
|  |   |                 |                                     |
| <b>GEV No.</b>  | 416614  | <b>Ref. No.</b> | 12023926<br>Z721701                 |
| <b>description</b>  | heating element 9600W 230V mounting $\phi$ 63mm heating circuits 3 L 425mm W 50mm H 45mm thermostat sleeves $\phi$ 6.5mm length thermostat sleeves 200mm number of thermostat sleeves 1 thermostat sleeve eccentric, non clinging tube $\phi$ 6.5mm hole distance 82mm hole $\phi$ 7mm connection M4 immersion heater 6 hole flange |                 |                                     |
| <b>For models:</b>  | CO-142W, CO-142WDD, FI-100, FI-100AR, FI-100B, FI-100BBT-UK, FI-120, FI-80, FI-80W, FI-E-100, LABP-1000, ME9-10BM, ME9-10BMS, ME9-15BM, ME9-15BM316, ME9-15BMS, MPE9-10BM, MPE9-10BMS, MPE9-15BM, MPE9-15BMS  |                 |                                     |
| <b>spare parts for</b>  | 416614  |                 |                                     |
|  | <b>GEV No.</b>  | 532163          | <b>Ref. No.</b> —                   |
|   | O-ring EPDM thickness 5.34mm ID $\phi$ 62.87mm Qty 10 pcs   |                 |                                     |
|  | <b>GEV No.</b>  | 691033          | <b>Ref. No.</b> 12010051<br>Q307035 |
|   | O-ring EPDM thickness 5.34mm ID $\phi$ 62.87mm Qty 1 pcs  |                 |                                     |

|  |  |                 |                                   |
|--|--|-----------------|-----------------------------------|
|  |  |                 |                                   |
| <b>GEV No.</b>   | 419270   | <b>Ref. No.</b> | 12024349<br>T323034<br>T323034000 |
| <b>description</b>   | heating element 15000W 230V heating circuits 3 ID $\phi$ 540mm ED $\phi$ 560mm L 580mm H 148mm W1 160mm H1 16mm H2 132mm flange length 210mm flange width 30mm hole distance 180mm connection M4 tube $\phi$ 10mm mounting thread M6 |                 |                                   |
| <b>For models:</b>   | ACE-102, ACE-202, AE-102, AE-102W, AE-202, APE-102, APE-102W, APE-202  |                 |                                   |

|   |  |                 |                     |
|---|--|-----------------|---------------------|
|  |  |                 |                     |
| <b>GEV No.</b>  | 417222   | <b>Ref. No.</b> | 12017628<br>Z603601 |
| <b>description</b>  | heating element 2000W 230V heating circuits 1 L 280mm W 140mm H 23mm thread 1/4" mounting distance 132mm tube $\phi$ 8mm connection male faston 6.3mm immersion heater 2 hole fixing stainless steel |                 |                     |

|   |  |                 |                                   |
|---|--|-----------------|-----------------------------------|
|  |  |                 |                                   |
| <b>GEV No.</b>  | 419271   | <b>Ref. No.</b> | 12024359<br>T323035<br>T323035000 |
| <b>description</b>  | heating element 15000W 230V heating circuits 3 ID $\phi$ 620mm ED $\phi$ 640mm L 660mm H 152mm W1 160mm H1 20mm H2 132mm flange length 210mm flange width 30mm hole distance 180mm connection M4 tube $\phi$ 10mm mounting thread M6 |                 |                                   |
| <b>For models:</b>  | ACE-102, ACE-202, AE-102, AE-102W, AE-202, APE-102, APE-102W, APE-202  |                 |                                   |

|   |   |                 |                     |
|---|---|-----------------|---------------------|
|  |   |                 |                     |
| <b>GEV No.</b>  | 416235  | <b>Ref. No.</b> | 12030300<br>EU80677 |
| <b>description</b>  | heating element 3000W 230V heating circuits 1 L 320mm W 50mm H 40mm thread M10x1 mounting distance 44mm tube $\phi$ 6.3mm connection male faston 6.3mm 2 hole fixing L1 32mm L2 288mm |                 |                     |
| <b>spare parts for</b>  | 416235  |                 |                     |
|  | <b>GEV No.</b>  | 510893          | <b>Ref. No.</b> —   |
|   | O-ring EPDM thickness 2.62mm ID $\phi$ 9.92mm Qty 1 pcs   |                 |                     |
| <b>accessories for</b>  | 416235  |                 |                     |
|  | <b>GEV No.</b>  | 510416          | <b>Ref. No.</b> —   |
|   | flat gasket fibre ED $\phi$ 19mm ID $\phi$ 10.5mm thickness 1.5mm for thread M10 Qty 1 pcs  |                 |                     |
|  | <b>GEV No.</b>  | 510893          | <b>Ref. No.</b> —   |
|   | O-ring EPDM thickness 2.62mm ID $\phi$ 9.92mm Qty 1 pcs   |                 |                     |
|  | <b>GEV No.</b>  | 521129          | <b>Ref. No.</b> —   |
|   | nut thread M10 H 6mm SS WS 17 Qty 1 pcs DIN/ISO DIN 439   |                 |                     |
|  | <b>GEV No.</b>  | 560192          | <b>Ref. No.</b> —   |
|   | tooth lock washer ID $\phi$ 10.4mm ED $\phi$ 18mm SS DIN/ISO DIN 6798A Qty 1 pcs for thread M10   |                 |                     |

|  |  |                 |                        |
|--|--|-----------------|------------------------|
|  |  |                 |                        |
| <b>GEV No.</b>   | 417670   | <b>Ref. No.</b> | 12026971<br>RT32001002 |
| <b>description</b>   | heating element 15000W 230V heating circuits 6 ID $\phi$ 505mm ED $\phi$ 517mm L 620mm H 195mm W1 155mm H1 27mm H2 168mm flange length 210mm flange width 25mm |                 |                        |

electric components





Зип Общежит

vsezip.ru



+7(812)987-08-81

|   |   |                 |                     |
|---|---|-----------------|---------------------|
|  |   |                 |                     |
| 1   |   |                 |                     |
| <b>GEV No.</b>  | 417198  | <b>Ref. No.</b> | 12018441<br>T323002 |
| <b>description</b>  | heating element 15000W 230V heating circuits 6 ID $\phi$ 508mm ED $\phi$ 515mm L 605mm H 205mm L1 30mm H1 35mm H2 170mm flange length 210mm flange width 30mm tube $\phi$ 8.5mm mounting pos. inner |                 |                     |
| <b>For models:</b>  | HEI-10-21, HEM-10-21  |                 |                     |

|  |   |                 |                       |
|--|---|-----------------|-----------------------|
|  |   |                 |                       |
| 1  |   |                 |                       |
| <b>GEV No.</b>   | 417676  | <b>Ref. No.</b> | 12038126<br>RT4000265 |
| <b>description</b>   | heating element 18000W 230V heating circuits 3 ID $\phi$ 410mm ED $\phi$ 477mm L 477mm H 110mm W1 110mm H1 20mm H2 90mm flange length 140mm flange width 62mm hole distance 64mm connection cable connection length 70mm tube $\phi$ 6.3mm convection heating element |                 |                       |

|   |   |                 |  |
|---|---|-----------------|--|
|    |   |                 |  |
| 1   |   |                 |  |
| <b>GEV No.</b>  | 417675  | <b>Ref. No.</b> | 12026859<br>12026880<br>RT32001003<br>RT32001017 |
| <b>description</b>  | heating element 15000W 230V heating circuits 6 ID $\phi$ 635mm ED $\phi$ 650mm L 696mm H 200mm L1 23mm W1 156mm H1 35mm H2 165mm flange length 210mm flange width 24mm hole distance 31mm connection male faston 6.3mm connection length 80mm tube $\phi$ 6.3mm convection heating element hole $\phi$ 7mm mounting pos. outer rectangular flange |                 |  |
| <b>spare parts for</b>  | 417675  |                 |  |
|  | <b>GEV No.</b>  | 512484          | <b>Ref. No.</b>                                  |
|   |   |                 | 12035774<br>RT51101009                           |
| gasket L 210mm W 24mm thickness 2mm for heating element                             |   |                 |  |

|  |   |                 |                       |
|--|---|-----------------|-----------------------|
|  |   |                 |                       |
| 1  |   |                 |                       |
| <b>GEV No.</b>   | 417677  | <b>Ref. No.</b> | 12025968<br>RT4000597 |
| <b>description</b>   | heating element 18000W 230V heating circuits 6 ID $\phi$ 407mm ED $\phi$ 485mm L 485mm H 106mm W1 111mm H1 11mm H2 85mm flange length 140mm flange width 72mm hole distance 128mm connection cable connection length 98mm tube $\phi$ 6.6mm cable length 600mm convection heating element hole $\phi$ 5mm rectangular flange L1 485mm |                 |                       |

|  |   |                 |                       |
|--|---|-----------------|-----------------------|
|          |   |                 |                       |
| 1  |   |                 |                       |
| <b>GEV No.</b>   | 417683  | <b>Ref. No.</b> | 12025672<br>RT4000267 |
| <b>description</b>   | heating element 30000W 230V heating circuits 6 ID $\phi$ 573mm ED $\phi$ 630mm L 655mm H 120mm W1 135mm H1 15mm H2 110mm flange length 160mm flange width 75mm hole distance 74mm connection cable connection length 95mm tube $\phi$ 8.5mm cable length 600mm convection heating element hole $\phi$ 6mm rectangular flange L1 8mm |                 |                       |
| <b>accessories for</b>   | 417683  |                 |                       |
|           | <b>GEV No.</b>  | 560611          | <b>Ref. No.</b>       |
|  |   |                 | —                     |
| gasket L 160mm W 75mm for heating element thickness 2mm hole distance 74mm SCC Linie 102/202 |   |                 |                       |

|   |   |                 |                     |
|---|---|-----------------|---------------------|
|  |   |                 |                     |
| 1   |   |                 |                     |
| <b>GEV No.</b>  | 417199  | <b>Ref. No.</b> | 12018381<br>T323000 |
| <b>description</b>  | heating element 15000W 230V heating circuits 6 ID $\phi$ 650mm ED $\phi$ 668mm L 670mm H 213mm W1 158mm H1 35mm H2 165mm flange length 210mm flange width 30mm tube $\phi$ 8mm convection heating element mounting pos. outer |                 |                     |
| <b>For models:</b>  | HEI-10-21, HEM-10-21  |                 |                     |



Зип Общепит

vsezip.ru

+7(812)987-08-81



1

|                    |   |                 |                       |
|--------------------|---|-----------------|-----------------------|
| <b>GEV No.</b>     | 417690  | <b>Ref. No.</b> | 12027912<br>RT4000261 |
| <b>description</b> | heating element 9000W 230V heating circuits 3 ID ø 407mm ED ø 420mm L 443mm H 105mm W1 107mm H1 21mm H2 88mm flange length 140mm flange width 62mm hole distance 65mm connection cable connection length 90mm tube ø 6.5mm cable length 270mm convection heating element hole ø 5mm rectangular flange L1 6mm |                 |                       |



1

|                    |   |                 |                                   |
|--------------------|---|-----------------|-----------------------------------|
| <b>GEV No.</b>     | 419269  | <b>Ref. No.</b> | T803051<br>T803051000<br>12039497 |
| <b>description</b> | heating element 9000W 230V heating circuits 3 ID ø 490mm ED ø 507mm L 53mm H 100mm L1 14mm W1 100mm H1 83mm H2 17mm flange length 142mm flange width 25mm mounting distance 125mm connection M4 tube ø 8.5mm mounting thread M6 |                 |                                   |
| <b>For models:</b> | ACE-101, ACE-201, AE-101, AE-101W, AE-201, APE-101, APE-101W, APE-201   |                 |                                   |



1

|   |  |                 |                                   |                        |
|---|--|-----------------|-----------------------------------|------------------------|
| <b>GEV No.</b>  | 419268   | <b>Ref. No.</b> | 12039496<br>T803050<br>T803050000 |                        |
| <b>description</b>  | heating element 9000W 230V heating circuits 3 ID ø 410mm ED ø 417mm L 450mm H 100mm L1 15mm W1 105mm H1 80mm H2 20mm flange length 142mm flange width 25mm mounting distance 125mm connection M4 tube ø 8.5mm mounting thread M6 |                 |                                   |                        |
| <b>For models:</b>  | ACE-061, ACE-101, ACE-201, AE-061, AE-061W, AE-101, AE-101W, AE-201, APE-061, APE-061W, APE-101, APE-101W, APE-201   |                 |                                   |                        |
| <b>accessories for</b>  | 419268   |                 |                                   |                        |
|  | <b>GEV No.</b>   | 521284          | <b>Ref. No.</b>                   | 12041165<br>T803052000 |
|   | gasket for heating element L 142mm W 25mm thickness 2mm graphite   |                 |                                   |                        |



1

|                    |  |                 |                        |
|--------------------|--|-----------------|------------------------|
| <b>GEV No.</b>     | 417693   | <b>Ref. No.</b> | 12026871<br>RT32001001 |
| <b>description</b> | heating element 9000W 230V heating circuits 3 ID ø 504mm ED ø 516mm L 535mm H 130mm W1 156mm H1 35mm H2 95mm flange length 210mm flange width 25mm hole distance 31mm connection male faston 6.3mm connection length 80mm tube ø 6.5mm dry heating element hole ø 7.5mm mounting pos. outer rectangular flange L1 19mm |                 |                        |



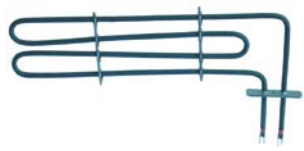

1

|   |  |                 |                 |                        |
|---|--|-----------------|-----------------|------------------------|
| <b>GEV No.</b>  | 417692   | <b>Ref. No.</b> | 12028209        |                        |
| <b>description</b>  | heating element 9000W 230V heating circuits 3 ID ø 445mm ED ø 458mm L 474mm H 130mm W1 156mm H1 33mm H2 97mm flange length 210mm flange width 25mm hole distance 31mm connection male faston 6.3mm connection length 80mm tube ø 6.5mm dry heating element hole ø 7.5mm mounting pos. inner rectangular flange |                 |                 |                        |
| <b>accessories for</b>  | 417692   |                 |                 |                        |
|  | <b>GEV No.</b>   | 512484          | <b>Ref. No.</b> | 12035774<br>RT51101009 |
|   | gasket L 210mm W 24mm thickness 2mm for heating element  |                 |                 |                        |



1



|   |   |                 |                     |                     |
|---|---|-----------------|---------------------|---------------------|
| <b>GEV No.</b>  | 416634  | <b>Ref. No.</b> | 12024692<br>R663016 |                     |
| <b>description</b>  | heating element 1500W 230V heating circuits 1 L 350mm W 102mm L1 30mm L2 320mm W2 82mm flange length 70mm flange width 22mm hole distance 56mm connection length 71mm connection male faston 6.3mm tube ø 6.3mm hole ø 6mm W1 20mm rectangular flange convection heating element windings 2 |                 |                     |                     |
| <b>For models:</b>  | COE-061, HEI-6-11, HEM-6-11, HEP-6-11, HME-6-11, HMI-6-11, HMI-6-11UL, HMM-6-11, HMM-6-11UL, HMP-6-11, VE-061, VPE-061  |                 |                     |                     |
| <b>spare parts for</b>  | 416634  |                 |                     |                     |
|  | <b>GEV No.</b>  | 510368          | <b>Ref. No.</b>     | —                   |
|   | gasket L 70mm W 23.5mm hole ø 5mm hole distance 56mm FIBER thickness 2mm for heating element  |                 |                     |                     |
| <b>accessories for</b>  | 416634  |                 |                     |                     |
|  | <b>GEV No.</b>  | 550761          | <b>Ref. No.</b>     | 12023637<br>R693017 |
|   | gasket L 69mm W 22mm D1 ø 12mm D2 ø 6mm graphite thickness 2mm for heating element  |                 |                     |                     |

Зип Общепит  
hot plates

square & rectangular  
with radused edge

vsezip.ru  
+7(812)987-08-81

|   |  |                 |  |
|---|--|-----------------|--|
|  |  |                 |  |
| <b>GEV No.</b>  | 417658   | <b>Ref. No.</b> | 12031112<br>12043757<br>D01AC02257<br>D01AC02254<br>D01AC02257 |
| <b>description</b>  | heating element 2000W 230V L 500mm W 86mm connection male faston 6.3mm |                 |  |
| <b>For models:</b>  | SF-13, SF-8  |                 |  |

|   |  |                 |                                     |
|---|--|-----------------|-------------------------------------|
|  |  |                 |                                     |
| <b>GEV No.</b>  | 416620   | <b>Ref. No.</b> | 12024727<br>R673002                 |
| <b>description</b>  | heating element 3000W 230V heating circuits 2 L 570mm W 100mm L1 70mm L2 500mm W2 70mm flange length 100mm flange width 22mm hole distance 44mm connection length 90mm connection male faston 6.3mm tube ø 8.5mm hole ø M5mm W1 30mm rectangular flange convection heating element |                 |                                     |
| <b>For models:</b>  | COE-101, HEI-10-11, HEM-10-11, HEP-10-11, HME-10-11, HMI-10-11, HMI-10-11UL, HMM-10-11, HMM-10-11UL, HMP-10-11, VE-101, VPE-101  |                 |                                     |
| <b>accessories for</b>  | 416620   |                 |                                     |
|  | <b>GEV No.</b>   | 550760          | <b>Ref. No.</b> 12023655<br>R673063 |
|   | gasket L 100mm W 22mm D1 ø 12mm D2 ø 7mm graphite thickness 2mm for heating element  |                 |                                     |

|   |  |                 |                     |
|---|--|-----------------|---------------------|
|  |  |                 |                     |
| <b>GEV No.</b>  | 416621   | <b>Ref. No.</b> | 12017124<br>R093002 |
| <b>description</b>  | heating element 4000W 230V heating circuits 2 L 1155mm W 100mm L1 70mm L2 1085mm W2 75mm flange length 100mm flange width 22mm hole distance 88mm connection length 90mm connection male faston 6.3mm tube ø 8mm hole ø M6mm W1 25mm rectangular flange convection heating element |                 |                     |
| <b>For models:</b>  | COE-201, HEI-20-11, HEM-20-11, HEP-20-11, HME-20-11, HMM-20-11, HMM-20-11UL, HMP-20-11, MFHMM-20-11, VE-201, VPE-201   |                 |                     |

|   |   |                 |                     |
|---|---|-----------------|---------------------|
|  |   |                 |                     |
| <b>GEV No.</b>  | 416019  | <b>Ref. No.</b> | 12017453<br>R683000 |
| <b>description</b>  | heating element 4000W 230V heating circuits 2 L 570mm W 100mm L1 70mm L2 500mm W2 70mm flange length 100mm flange width 22mm hole distance 44mm connection length 90mm connection male faston 6.3mm tube ø 8mm W1 30mm rectangular flange convection heating element mounting thread M6 |                 |                     |
| <b>For models:</b>  | HEP-10-11, HME-10-21, HME-20-11, HME-20-21, HME-2-10-11, HME-2-20-11, HMI-10-21, HMI-10-21UL, HMI-2-10-11, HMM-10-21, HMM-10-21UL, HMM-20-21, HMM-20-21UL, HMM-2-10-11, HMM-2-20-11, HMM-40-11-USMC, HMP-10-21, HMP-20-11, HMP-20-21, HMP-2-10-11, HMP-2-20-11                          |                 |                     |

|  |   |                 |                     |
|--|---|-----------------|---------------------|
|  |   |                 |                     |
| <b>GEV No.</b>   | 490056 <sup>1</sup>   | <b>Ref. No.</b> | 12024805<br>U673011 |
| <b>description</b>   | hot plate dimensions 300x300mm 3000W 230V with spill ring connection 4 screw clamps protector yes square            |                 |                     |
| <b>For models:</b>   | CE7-20Q, CE7-40Q, CE7-41Q, CE9-20, CE9-20AD, CE9-20PLUS, CE9-40, CE9-40AD, CE9-40PLUS, CE9-41, CE9-41AD, CE9-41PLUS |                 |                     |

<sup>1</sup>incl. protector

|   |   |                 |                     |
|---|---|-----------------|---------------------|
|  |   |                 |                     |
| <b>GEV No.</b>  | 490073  | <b>Ref. No.</b> | 12024803<br>U673012 |
| <b>description</b>  | hot plate dimensions 300x300mm 3000W 400V with spill ring connection 4 screw clamps protector no square |                 |                     |
| <b>For models:</b>  | CE7-20Q, CE7-40Q, CE7-41Q, CE9-20, CE9-40, CE9-41   |                 |                     |

|  |  |                 |                     |
|--|--|-----------------|---------------------|
|  |  |                 |                     |
| <b>GEV No.</b>   | 490071 <sup>1</sup>  | <b>Ref. No.</b> | 12024806<br>U673010 |
| <b>description</b>   | hot plate dimensions 300x300mm 4000W 230V with spill ring connection 4 screw clamps protector yes square |                 |                     |
| <b>For models:</b>   | CE9-20, CE9-20AD, CE9-20PLUS, CE9-40, CE9-40AD, CE9-40PLUS, CE9-41, CE9-41AD, CE9-41PLUS                 |                 |                     |

<sup>1</sup>incl. protector





Зип Общепит  
energy regulators

EGO  
1-circuit

+7(812)987-08-81

|   |  |          |                     |
|---|--|----------|---------------------|
|  |  |          |                     |
| GEV No.   | 490074 <sup>1</sup>  | Ref. No. | 12024802<br>U673013 |
| description   | hot plate dimensions 300x300mm 4000W 400V with spill ring connection 4 screw clamps protector yes square |          |                     |
| For models:   | CE9-20, CE9-40, CE9-41   |          |                     |

<sup>1</sup>incl. protector

round  
with radiused edge  
for domestic and commercial kitchens

|   |  |          |                     |
|---|--|----------|---------------------|
|  |  |          |                     |
| GEV No.   | 490012   | Ref. No. | 12024602<br>U803002 |
| description   | hot plate ø 145mm 1500W 230V connection 4 screw clamps with 8mm spill ring |          |                     |
| For models:   | CE6-40, CE6-41, CE7-20, CE7-40, CE7-41                                     |          |                     |



|   |  |          |                     |
|---|--|----------|---------------------|
|  |  |          |                     |
| GEV No.   | 490020   | Ref. No. | 12024076<br>U803000 |
| description   | hot plate ø 220mm 2600W 230V connection 4 screw clamps with 8mm spill ring |          |                     |
| For models:   | CE7-20, CE7-40, CE7-41   |          |                     |
| accessories for   | 490020   |          |                     |
|   | GEV No.  | 550796   | Ref. No.            |
|   |  |          | —                   |
|   | fixing plate for hot plate ø220mm  |          |                     |

|  |  |          |   |
|--|--|----------|---|
|  |  |          |   |
| GEV No.  | 380015   | Ref. No. | 12024522<br>12029890<br>K002B42045<br>S333001 |
| description  | energy regulator 230V 13A single-circuit turn direction right shaft ø 6x4.6mm shaft L 23mm mounting thread M4 power release 6-100% no. 50.57021.010  |          |   |
| For models:  | CPE6-05, CPE7-05, CPE7-05NC, CPE9-05, CPE9-05AD, CPE9-05AD-S, CPE9-05NC, CPE9-05PLUS, CPE9-05PLUS-S, CPE9-05S, CPE9-05SNC, CV6-20, CV6-40, EPC-350, HGV-10-11, HGV-20-11, HVG-10-11, HVG-10-11UL, HVG-10-21, HVG-10-21UL, HVG-20-11, HVG-20-21, HVG-2-10-11, HVG-2-20-21, ME7-10BM, ME9-10BM, ME9-10BMS, ME9-10PLUS-BM, ME9-10PLUS-BMS, ME9-15BM, ME9-15BM316, ME9-15BM-AD, ME9-15BMS, ME9-15PLUS-BM, ME9-15PLUS-BMS, MFHVG-10-11, MFHVG-10-21, MG9-10AD, MG9-10BMAD, MG9-10BMSAD, MG9-10PLUS, MG9-10PLUS-BM, MG9-10PLUS-BMS, MG9-10PLUS-S, MG9-10S-AD, MG9-15AD, MG9-15BMAD, MG9-15BMSAD, MG9-15PLUS, MG9-15PLUS-BM...(Other models you can see in the webshop) |          |   |

thermostats

bi-metal thermostats

safety bi-metal thermostats

|   |  |          |                        |
|---|--|----------|------------------------|
|  |  |          |                        |
| GEV No.   | 390590   | Ref. No. | 12033906<br>BR00C23114 |
| description   | bi-metal safety thermostat hole distance 24mm switch-off temp.°C 1NC 1-poleAV connection plug 2 hole fixing  |          |                        |
|  |  |          |                        |
| GEV No.   | 390451   | Ref. No. | 12025141<br>R213004    |
| description   | bi-metal safety thermostat hole distancemm switch-off temp. 115°C 1NC 1-pole 16A connection F6.3   |          |                        |
| For models:   | AD-120, AD-120B, AD-120BBTDD-UK, AD-120C, AD-120CW, AD-120HY, AD-90, AD-90BA, AD-90BBT, AD-90BDD, AD-90DD, ADE-120, ADE-120B, BME7-05, BME7-10, BME9-05, BME9-10, ECO-120, ECO-120B, FI-100, FI-100AR, FI-100B, FI-100BBT-UK, FI-120, FI-120AR+DD, FI-120B, FI-120C, FI-120HY-CLINIC, FI-120W, FI-80, FI-80AR, FI-80BBT-UK, FI-80W, FI-E-100, LABP-1000, LABP-1200, MF-120 |          |                        |
| accessories for   | 390451   |          |                        |
|   | GEV No.  | 505093   | Ref. No.               |
|   |  |          | 12024049<br>N503017    |
|   | gasket for thermostat ED ø 35mm ID ø 24mm thickness 7mm equiv. no. N503017   |          |                        |

1 electric components



bi-metal thermostats



|                    |   |                 |          |
|--------------------|---|-----------------|----------|
| <b>GEV No.</b>     | 391045  | <b>Ref. No.</b> | 12095019 |
| <b>description</b> | bi-metal thermostat hole distance 23.5mm switch-off temp. 51°C 1NC 1-pole 10A connection F6.3 threaded probe ø 16mm   |                 |          |
| <b>For models:</b> | ACE-061, ACE-101, ACE-102, ACE-201, ACE-202, ACG-061, ACG-101, ACG-102, ACG-201, ACG-202, AE-061, AE-101, AE-102, AE-201, AE-202, AG-061, AG-101, AG-102, AG-201, AG-202, CO-350, CO-350-B, CO-350-B-DD, CO-350-COLD, CO-350-COLD-B, CO-350-COLD-B-DD, CO-350-COLD-DD, CO-350-DD, CO-400, CO-400-B, CO-400-B-DD, CO-400-COLD, CO-400-COLD-B, CO-400-COLD-B-DD, CO-400-COLD-DD, CO-400-DD, CO-400-SOFT |                 |          |



|                    |   |                 |                        |
|--------------------|---|-----------------|------------------------|
| <b>GEV No.</b>     | 375160  | <b>Ref. No.</b> | 12035324<br>RT30140325 |
| <b>description</b> | bi-metal thermostat hole distance mm switch-off temp. 110°C 1NC 1-pole 16A connection F6.3 M4 |                 |                        |



|                        |   |                 |                                |                     |
|------------------------|---|-----------------|--------------------------------|---------------------|
| <b>GEV No.</b>         | 390450  | <b>Ref. No.</b> | 12023708<br>Z653013<br>Z718405 |                     |
| <b>description</b>     | bi-metal thermostat hole distance mm switch-off temp. 66/57°C NC/NO 2-pole 16A connection F6.3  |                 |                                |                     |
| <b>For models:</b>     | EASY-500, EASY-500B, EASY-500DD, EASY-500HP, EASY-500HPWBDD, ECO-120, ECO-1200, ECO-120B, FI-100, FI-100AR, FI-100B, FI-100BBT-UK, FI-120, FI-1200, FI-120AR+DD, FI-120B, FI-120C, FI-120HY-CLINIC, FI-120W, FI-30, FI-300B, FI-300R, FI-30AR, FI-30AR+DD, FI-30B, FI-30B-BT-UK, FI-30-UK, FI-48, FI-48B, FI-48B-BT-UK, FI-48D, FI-48W, FI-60DD, FI-64, FI-64AR, FI-64B, FI-64C, FI-64D, FI-64W, FI-650R, FI-72, FI-72AR, FI-80, FI-80AR, FI-80BBT-UK, FI-80W, FI-900, LABP-1000, LABP-1200, LABP-800...(Other models you can see in the webshop) |                 |                                |                     |
| <b>accessories for</b> | 390450  |                 |                                |                     |
|                        | <b>GEV No.</b>  | 505093          | <b>Ref. No.</b>                | 12024049<br>N503017 |
|                        | gasket for thermostat ED ø 35mm ID ø 24mm thickness 7mm equiv. no. N503017  |                 |                                |                     |

Зип Общепит

vsezip.ru

+7(812)987 08 81



|                        |   |                 |                     |                     |
|------------------------|---|-----------------|---------------------|---------------------|
| <b>GEV No.</b>         | 390428  | <b>Ref. No.</b> | 12023814<br>P503025 |                     |
| <b>description</b>     | bi-metal thermostat hole distance mm switch-off temp. °C 1NO/1NC 2-pole 15A 250V connection F6.3  |                 |                     |                     |
| <b>For models:</b>     | LA-13M, LA-18MP, LA-25M, LA-AC-10M, LA-AC-10MA, LA-AC-10MP, LA-AC-13M, LA-AC-13MA, LA-AC-13MP, LA-AC-18M, LA-AC-18MA, LA-AC-18MP, LA-AC-25M, LA-AC-25MA, LA-AC-25MP, LAC-10MP, LAC-10MPP, LAC-14MP, LAC-14MPP, LAC-25MP, LAC-25MPP, LAC-55MP, LAC-55MPP, LAC-7MP, LAC-7MPP, LA-E-10M, LA-E-10MA, LA-E-10MP, LA-E-13M, LA-E-13MA, LA-E-13MP, LA-E-18M, LA-E-18MA, LA-E-18MP, LA-E-25M, LA-E-25MA, LA-E-25MP, LA-V-10M, LA-V-10MP, LA-V-13M, LA-V-13MP, LA-V-18M, LA-V-18MP, LA-V-25M, LA-V-25MP, LB-AC-10M, LB-E-10M, LB-V-10M, LF-13MPP, LF-18MPP...(Other models you can see in the webshop) |                 |                     |                     |
| <b>accessories for</b> | 390428  |                 |                     |                     |
|                        | <b>GEV No.</b>  | 505093          | <b>Ref. No.</b>     | 12024049<br>N503017 |
|                        | gasket for thermostat ED ø 35mm ID ø 24mm thickness 7mm equiv. no. N503017  |                 |                     |                     |

control and safety thermostats

EGO

control thermostats

55.13\_ series

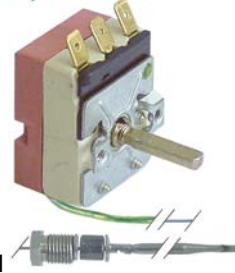

|                    |  |                 |                     |
|--------------------|--|-----------------|---------------------|
| <b>GEV No.</b>     | 375415   | <b>Ref. No.</b> | 12018245<br>R343018 |
| <b>description</b> | thermostat t.max. 105°C temperature range 52-105°C 1-pole 1CO 16A probe ø 3.03mm probe L 201mm capillary pipe 2380mm capillary pipe isolated 2200mm gland nut M9x1 shaft ø 6x4.6mm shaft L 23mm shaft position upper rotation 270°   |                 |                     |
| <b>For models:</b> | HCV-10-11, HCV-10-21, HCV-2-10-21, HCV-5-11, HCV-6-11, HEI-10-11, HEI-20-11, HEI-6-11, HGV-10-11, HGV-20-11, HMI-10-11, HMI-10-11UL, HMI-10-21, HMI-10-21UL, HMI-2-10-11, HMI-6-11, HMI-6-11UL, HMM-10-11, HMM-10-11UL, HMM-10-21, HMM-10-21UL, HMM-20-11, HMM-20-11UL, HMM-20-21, HMM-20-21UL, HMM-2-10-11, HMM-40-11-USMC, HMM-6-11, HMM-6-11UL, HVG-10-11, HVG-10-11UL, HVG-10-21, HVG-10-21UL, HVG-20-11, HVG-20-21, HVG-2-10-11, HVG-2-20-21, MFHMM-20-11, MFHVG-10-11, MFHVG-10-21 |                 |                     |



Зип Общепит

vsezip.ru

+7(812)987-08-81



|                    |   |                 |                                   |
|--------------------|---|-----------------|-----------------------------------|
| <b>GEV No.</b>     | 375123  | <b>Ref. No.</b> | 12024662<br>K008B41006<br>X033000 |
| <b>description</b> | thermostat t.max. 215°C temperature range 60-215°C 1-pole 1NO 16A probe ø 6mm probe L 77mm capillary pipe 2250mm capillary pipe isolated 2100mm gland nut shaft L 23mm shaft position upper rotation 270° |                 |                                   |
| <b>For models:</b> | FE-18, FE-25, FE-4, FE-6, FE6-05TE, FE6-10TE, FE-71-15, FE-8, FE-91-20  |                 |                                   |



|                    |  |                 |                                   |
|--------------------|--|-----------------|-----------------------------------|
| <b>GEV No.</b>     | 390086   | <b>Ref. No.</b> | 12018764<br>R013002<br>R013002000 |
| <b>description</b> | thermostat t.max. 300°C temperature range -10 to +300°C 1-pole 1CO probe ø 3mm probe L 201mm capillary pipe 1170mm capillary pipe isolated 1100mm shaft ø 6x4.6mm shaft L 26mm rotation 250° probe material SS |                 |                                   |



|                    |  |                 |                     |
|--------------------|--|-----------------|---------------------|
| <b>GEV No.</b>     | 375204   | <b>Ref. No.</b> | 12024623<br>X163010 |
| <b>description</b> | thermostat t.max. 215°C temperature range 61-215°C 1-pole 1NO 16A probe ø 3.1mm probe L 201mm capillary pipe 870mm capillary pipe isolated 600mm gland nut M9x1 shaft L 23mm shaft position upper rotation 270°  |                 |                     |
| <b>For models:</b> | FE6-05, FE6-10, FE7-05-1C, FE7-05-2C, FE-710, FE7-10-2C, FE7-10-4C, FE-720, FE9-05, FE9-05-1C, FE9-05-2C, FE9-05AD, FE9-05PLUS, FE9-05PLUS-S, FE9-05S, FE9-05S-1C, FE9-05S-2C, FE9-05S-AD, FE9-05US-MC, FE9-10, FE9-10-2C, FE9-10-4C, FE9-10AD, FE9-10PLUS, FE-920, FG7-05-1C, FG7-05-2C, FG-710, FG7-10-2C, FG7-104C, FG7-10-4C, FG-720, FG9-05, FG9-05-1C, FG9-05-2C, FG9-05AD, FG9-05PLUS, FG9-05PLUS-S, FG9-05S, FG9-05S-1C, FG9-05S-2C, FG9-05S-AD, FG9-10, FG9-10-2C, FG9-10-4C, FG9-10AD, FG9-10PLUS, FG-920, FGCL9-05, FGCL9-05-1C...(Other models you can see in the webshop) |                 |                     |



|                    |  |                 |                     |
|--------------------|--|-----------------|---------------------|
| <b>GEV No.</b>     | 375459   | <b>Ref. No.</b> | 12024939<br>Z953001 |
| <b>description</b> | thermostat t.max. 82°C temperature range fixed 82°C 1-pole 1COA probe ø 15/9mm probe L 21mm capillary pipe 1000mm capillary pipe isolated 950mm gland nut shaft ømm shaft Lmm shaft position rotation° probe material SS |                 |                     |
| <b>For models:</b> | GA-20, GA-20D, GA-40, GA-40D   |                 |                     |



|                    |  |                 |                     |
|--------------------|--|-----------------|---------------------|
| <b>GEV No.</b>     | 375460   | <b>Ref. No.</b> | 12018390<br>R343073 |
| <b>description</b> | thermostat t.max. 255°C temperature range 55-255°C 1-pole 1NO 16A probe ø 3.1mm probe L 201mm capillary pipe 1170mm capillary pipe isolated 1100mm gland nut shaft ø 6x4.6mm shaft L 23mm shaft position upper |                 |                     |
| <b>For models:</b> | HCV-10-11, HCV-5-11  |                 |                     |



|                    |   |                 |                     |
|--------------------|---|-----------------|---------------------|
| <b>GEV No.</b>     | 375414  | <b>Ref. No.</b> | 12024648<br>R343100 |
| <b>description</b> | thermostat t.max. 85°C temperature range 30-85°C 1-pole 1CO 16A probe ø 6mm probe L 73mm capillary pipe 1540mm capillary pipe isolated 1400mm gland nut M9x1 shaft ø 6x4.6mm shaft L 23mm shaft position upper rotation 270°  |                 |                     |
| <b>For models:</b> | FI-120W, FI-80W, HCV-10-11, HCV-10-21, HCV-2-10-21, HCV-6-11, HEI-10-21, HEM-10-11, HEM-20-11, HEM-6-11, HEP-10-11, HEP-20-11, HEP-6-11, HGV-10-11, HGV-20-11, HME-10-11, HME-10-21, HME-20-11, HME-2-10-11, HME-2-20-11, HME-6-11, HMM-10-11, HMM-10-11UL, HMM-10-21, HMM-10-21UL, HMM-20-11, HMM-20-11UL, HMM-2-20-11, HMM-2-21UL, HMM-2-10-11, HMM-40-11-USMC, HMM-6-11, HMM-6-11UL, HMP-10-11, HMP-10-21, HMP-20-11, HMP-20-21, HMP-2-10-11, HMP-6-11, HVG-10-11, HVG-10-11UL, HVG-10-21, HVG-10-21UL, HVG-20-11, HVG-20-21, HVG-2-10-11, HVG-2-20-21, MFHMM-20-11, MFHVG-10-11...(Other models you can see in the webshop) |                 |                     |

Зип-Общепит

vsezip.ru

+7(812)987-08-81

E-G-O

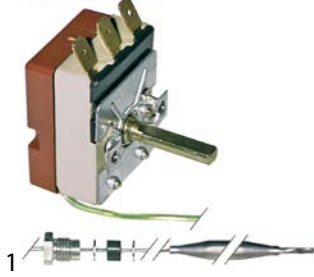

|                    |   |                 |                     |
|--------------------|---|-----------------|---------------------|
| <b>GEV No.</b>     | 375400  | <b>Ref. No.</b> | 12024096<br>Z393005 |
| <b>description</b> | thermostat t.max. 90°C temperature range 30-90°C 1-pole 1CO 16A probe ø 6mm probe L 98mm capillary pipe 2380mm capillary pipe isolated 1700mm gland nut M9x1 shaft ø 6x4.6mm shaft L 18mm shaft position upper rotation 270°  |                 |                     |
| <b>For models:</b> | AD-15, AD-15D, AD-20C-UK, AD-21, AD-21B, AD-21BDD, AD-21C, AD-21D, AD-21DD, AD-21W, AD-90, AD-90DD, FI-30, FI-30AR, FI-30AR+DD, FI-30B, FI-30B-BT-UK, FI-30-UK, FI-80, FI-80AR, FI-80W, LABP-800, LVC-12, LVC-15, LVC-15D, LVC-21, LVC-21B, LVC-21C, LVC-21D, LVC-21W, LVR-10, LVR-14, LVR-14D, LVR-20, LVR-20B, LVR-20D, MF-21 |                 |                     |

E-G-O

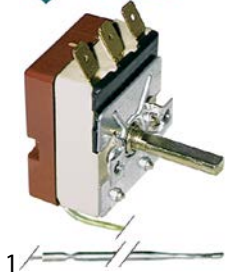

|                    |   |                 |   |
|--------------------|---|-----------------|---|
| <b>GEV No.</b>     | 375130  | <b>Ref. No.</b> | 12024573<br>12030953<br>AL00000121<br>Z203014 |
| <b>description</b> | thermostat t.max. 90°C temperature range 32-90°C 1-pole 1CO 16A probe ø 6mm probe L 129mm capillary pipe 710mm capillary pipe isolated 500mm gland nut shaft ø 6x4.6mm shaft L 23mm shaft position upper rotation 270°  |                 |   |
| <b>For models:</b> | AD-120, AD-120B, AD-120BBTDD-UK, AD-120C, AD-120CW, AD-120HY, AD-45BBT, AD-48, AD-48B, AD-48BDD, AD-48C, AD-48D, AD-48DD, AD-48HY, AD-48W, AD-64, AD-64B, AD-64BBT, AD-64BDD, AD-64C, AD-64CW, AD-64D, AD-64DD, AD-64HY, AD-72, AD-72W, AD-90, AD-90BA, AD-90BBT, AD-90BDD, AD-90DD, ADE-120, ADE-120B, BME6-05, BME7-05, BME7-10, BME9-05, BME9-05AD, BME9-05PLUS, BME9-05V-T, BME9-10, BME9-10AD, BME9-10PLUS, BME9-10V-T, ECO-120, ECO-120B, ECO-160, ECO-160D, ECO-160I...(Other models you can see in the webshop) |                 |   |

55.11\_ series



|                    |  |                 |          |
|--------------------|--|-----------------|----------|
| <b>GEV No.</b>     | 376094   | <b>Ref. No.</b> | 39FA0010 |
| <b>description</b> | thermostat t.max. 324°C temperature range 54-324°C 1-pole 1NO 16A probe ø 3.03mm probe L 160mm capillary pipe 1130mm capillary pipe isolated 870mm gland nut shaft ø 6x4.6mm shaft L 23mm shaft position upper rotation 270° |                 |          |

## safety thermostats

55.11\_ series

E-G-O



|                    |   |                 |                     |
|--------------------|---|-----------------|---------------------|
| <b>GEV No.</b>     | 375120  | <b>Ref. No.</b> | 12024600<br>X033001 |
| <b>description</b> | safety thermostat switch-off temp. 245°C 1-pole 16A probe ø 6mm probe L 77mm capillary pipe 2290mm capillary pipe isolated 2260mm gland nut probe SS  |                 |                     |
| <b>For models:</b> | FE-18, FE-25, FE-4, FE-6, FE6-05TE, FE6-10TE, FE-71-15, FE-8, FE-91-20, MG7-10BM, MG9-10BM, MG9-10BMAD, MG9-10BMS, MG9-10BMSAD, MG9-10PLUS-BM, MG9-10PLUS-BMS, MG9-15BM, MG9-15BM316, MG9-15BMAD, MG9-15BMS, MG9-15BMSAD, MG9-15PLUS-BM, MG9-15PLUS-BMS, MPG9-10BM, MPG9-10BMS, MPG9-15BM, MPG9-15BMS |                 |                     |

E-G-O



|                    |  |                 |                     |
|--------------------|--|-----------------|---------------------|
| <b>GEV No.</b>     | 375461   | <b>Ref. No.</b> | 12023818<br>Z953002 |
| <b>description</b> | safety thermostat switch-off temp. 92°C 1-pole 1NC 16A probe ø 9/15mm probe L 20mm capillary pipe 50mm capillary pipe isolated gland nut shaft ømm probe probe material SS |                 |                     |
| <b>For models:</b> | GA-20, GA-20D, GA-40, GA-40D   |                 |                     |



Зип Общепит

vsezip.ru

+7(812)987-08-81

55.12\_series



|                    |  |                 |                        |
|--------------------|--|-----------------|------------------------|
| <b>GEV No.</b>     | 375084   | <b>Ref. No.</b> | 12030006<br>RT30140328 |
| <b>description</b> | safety thermostat switch-off temp. 135°C 1-pole 10A probe ø 6mm probe L 83mm capillary pipe 1440mm capillary pipe isolated 1360mm gland nut probe SS |                 |                        |



|                    |   |                 |                       |
|--------------------|---|-----------------|-----------------------|
| <b>GEV No.</b>     | 375775  | <b>Ref. No.</b> | 12028861<br>RT4001329 |
| <b>description</b> | safety thermostat switch-off temp. 160°C 1-pole 10A probe ø 6mm probe L 87mm capillary pipe 1440mm capillary pipe isolated 1400mm gland nut probe |                 |                       |

55.13\_series



|                    |  |                 |                     |
|--------------------|--|-----------------|---------------------|
| <b>GEV No.</b>     | 375205   | <b>Ref. No.</b> | 12017873<br>X012130 |
| <b>description</b> | safety thermostat switch-off temp. 225°C 1-pole 16A probe ø 11mm probe L 16.5mm capillary pipe 830mm capillary pipe isolatedmm gland nut probe screw-in probe probe thread M14x1 |                 |                     |
| <b>For models:</b> | FE-710, FE-720, FE-920, FG-710, FG-720, FG-91-20, FG-920, FG-92-40   |                 |                     |



|                    |  |                 |                     |
|--------------------|--|-----------------|---------------------|
| <b>GEV No.</b>     | 390806   | <b>Ref. No.</b> | 12024607<br>X163001 |
| <b>description</b> | safety thermostat switch-off temp. 245°C 1-pole 16A probe ø 3.1mm probe L 201mm capillary pipe 870mm capillary pipe isolated 600mm gland nut M9x1 probe  |                 |                     |
| <b>For models:</b> | FE6-05, FE6-10, FE7-05-1C, FE7-05-2C, FE7-10-2C, FE7-10-4C, FE9-05, FE9-05-1C, FE9-05-2C, FE9-05AD, FE9-05PLUS, FE9-05PLUS-S, FE9-05S, FE9-05S-1C, FE9-05S-2C, FE9-05S-AD, FE9-10, FE9-10-2C, FE9-10-4C, FE9-10AD, FE9-10PLUS, FG6-05, FG6-10, FG7-05-1C, FG7-05-2C, FG7-10-2C, FG7-104C, FG7-10-4C, FG9-05, FG9-05-1C, FG9-05-2C, FG9-05AD, FG9-05PLUS, FG9-05PLUS-S, FG9-05S, FG9-05S-1C, FG9-05S-2C, FG9-05S-AD, FG9-10, FG9-10-2C, FG9-10-4C, FG9-10AD, FG9-10PLUS, FGCL9-05, FGCL9-05-1C, FGCL9-05-2C, FGCL9-05S-1C, FGCL9-05S-2C |                 |                     |



|                    |  |                 |                     |
|--------------------|--|-----------------|---------------------|
| <b>GEV No.</b>     | 375131   | <b>Ref. No.</b> | 12018982<br>X163040 |
| <b>description</b> | safety thermostat switch-off temp. 245°C 1-pole 16A probe ø 3.1mm probe L 201mm capillary pipe 870mm capillary pipe isolated 600mm gland nut probe |                 |                     |



|                    |   |                 |                     |
|--------------------|---|-----------------|---------------------|
| <b>GEV No.</b>     | 375416  | <b>Ref. No.</b> | 12019062<br>R243016 |
| <b>description</b> | safety thermostat switch-off temp. 329°C 1-pole 16A probe ø 3.03mm probe L 160mm capillary pipe 1230mm capillary pipe isolated 1060mm gland nut probe   |                 |                     |
| <b>For models:</b> | HCG-10-11, HCG-10-21, HCG-20-11, HCG-20-21, HCG-2-10-11, HCG-2-20-11, HCG-6-11, HCV-10-11, HCV-10-21, HCV-2-10-21, HCV-5-11, HCV-6-11, HE-10-11, HE-10-21, HE-2-10-11, HE-5-11, HE-6-11, HEI-10-11, HEI-20-11, HEI-6-11, HEM-10-11, HEM-20-11, HEM-6-11, HEP-10-11, HEP-20-11, HEP-6-11, HG-10-11, HG-10-21, HG-2-10-11, HGC-10-11, HGC-20-11, HGC-6-11, HGV-10-11, HGV-20-11, HME-10-11, HME-10-21, HME-20-11, HME-2-10-11, HME-2-20-11, HME-6-11, HMG-10-11, HMG-10-11UL, HMG-10-21, HMG-10-21UL, HMG-20-11, HMG-2-10-11, HMG-6-11, HMI-10-11, HMI-10-11UL... (Other models you can see in the webshop) |                 |                     |

Зип-Общепит

56\_ series

E-G-O  
vsezip.ru

+7(812)987-08-81



|                    |  |                 |                     |
|--------------------|--|-----------------|---------------------|
| <b>GEV No.</b>     | 375441   | <b>Ref. No.</b> | 12024591<br>T303009 |
| <b>description</b> | safety thermostat switch-off temp. 360°C 1-pole 1NC 16A probe ø 3mm probe L 110mm capillary pipe 870mm capillary pipe isolated 700mm gland nut probe screw connection M8x1 |                 |                     |



|                    |   |                 |                     |
|--------------------|---|-----------------|---------------------|
| <b>GEV No.</b>     | 375121  | <b>Ref. No.</b> | 12024691<br>R612103 |
| <b>description</b> | safety thermostat switch-off temp. 420°C 1-pole 1NO 16A probe ø 3.9mm probe L 228mm capillary pipe 1130mm capillary pipe isolated 700mm gland nut starting temperature 394°C probe  |                 |                     |
| <b>For models:</b> | CMF6-05, FTE6-05L, FTE6-05R, FTE6-10L, FTE6-10L+R, FTE6-10R, FTE7-05, FTE7-05L, FTE7-05R, FTE7-10, FTE7-10L, FTE7-10L+R, FTE7-10R, FTE9-05L, FTE9-05L-AD, FTE9-05PLUS-CL, FTE9-05PLUS-CR, FTE9-05PLUS-L, FTE9-05PLUS-R, FTE9-05R, FTE9-05R-AD, FTE9-10L, FTE9-10L+R, FTE9-10L+R-AD, FTE9-10L-AD, FTE9-10PLUS-CL, FTE9-10PLUS-CLR, FTE9-10PLUS-CR, FTE9-10PLUS-L, FTE9-10PLUS-LR, FTE9-10PLUS-R, FTE9-10R, FTE9-10R-AD, FTEC6-05L, FTEC6-10L, FTEC6-10L+R, FTEC7-05L, FTEC7-10L, FTEC9-05, FTEC9-05L, FTEC9-05L-AD, FTEC9-05R, FTEC9-05R-AD, FTEC9-05USMC, FTEC9-10, FTEC9-10L, FTEC9-10L+R, FTEC9-10L+R-AD, FTEC9-10L-AD, FTEC9-10R...(Other models you can see in the webshop) |                 |                     |

55.33\_ series



|                    |   |                 |          |
|--------------------|---|-----------------|----------|
| <b>GEV No.</b>     | 375764  | <b>Ref. No.</b> | 12124621 |
| <b>description</b> | safety thermostat switch-off temp. 282°C 3-pole 20A probe ø 4mm probe L 157mm capillary pipe 1770mm capillary pipe isolated 1490mm gland nut probe SS |                 |          |



|                    |   |                 |                     |
|--------------------|---|-----------------|---------------------|
| <b>GEV No.</b>     | 375447  | <b>Ref. No.</b> | 12024884<br>Z953035 |
| <b>description</b> | safety thermostat switch-off temp. 150°C 1-pole 1CO 16A probe ø 6mm probe L 77mm capillary pipe 1460mm capillary pipe isolated 1100mm gland nut M9x1 starting temperature 139°C probe   |                 |                     |
| <b>For models:</b> | AE-061, AE-061W, AE-101, AE-101W, AE-102, AE-102W, AE-201, AE-202, AG-061, AG-061W, AG-101, AG-101W, AG-102, AG-102W, AG-201, AG-202, APE-061, APE-061W, APE-101, APE-101W, APE-102, APE-102W, APE-201, APE-202, APG-061, APG-061W, APG-101, APG-101W, APG-102, APG-102W, APG-201, APG-202, GA-20, GA-20D, GA-40, GA-40D, HEM-10-21, HEM-20-21, HEP-10-21, HEP-20-21, HGP-10-21, HGP-20-21, HGV-10-11, HGV-20-11, HVG-10-11, HVG-10-11UL, HVG-10-21, HVG-10-21UL, HVG-20-11...(Other models you can see in the webshop) |                 |                     |



|                    |  |                 |          |
|--------------------|--|-----------------|----------|
| <b>GEV No.</b>     | 390854   | <b>Ref. No.</b> | 12048400 |
| <b>description</b> | safety thermostat switch-off temp. 245°C 1-pole 1NC 16A probe ø 3.1mm probe L 155mm capillary pipe 1130mm capillary pipe isolatedmm gland nut M9x1 probe |                 |          |



|                    |   |                 |  |
|--------------------|---|-----------------|--|
| <b>GEV No.</b>     | 375774  | <b>Ref. No.</b> | 12028972<br>12029862<br>RT4000605<br>RT4001482 |
| <b>description</b> | safety thermostat switch-off temp. 365°C 1-pole 16A probe ø 4mm probe L 96mm capillary pipe 1160mm capillary pipe isolated 1100mm gland nut probe SS with special screwing screw connection M10x1 |                 |  |



Зип Общепит

safety thermostats

vsezip.ru

+7(812)987-08-81

|   |  |                 |                        |
|---|--|-----------------|------------------------|
|  |  |                 |                        |
| <b>GEV No.</b>  | 375159   | <b>Ref. No.</b> | 12029569<br>RT30140326 |
| <b>description</b>  | safety thermostat switch-off temp. 365°C 1-pole 16A probe ø 4mm probe L 96mm capillary pipe 1160mm capillary pipe isolated 1100mm gland nut probe with special screwing screw connection M14x1 |                 |                        |

|  |   |                 |                                  |
|--|---|-----------------|----------------------------------|
|  |   |                 |                                  |
| <b>GEV No.</b>   | E90452  | <b>Ref. No.</b> | 12023830<br>R34312400<br>Z213014 |
| <b>description</b>   | safety thermostat switch-off temp. 125°C 1-pole 16A probe ø 6mm probe L 73mm capillary pipe 870mm capillary pipe isolated 690mm gland nut M9x1 probe SS   |                 |                                  |
| <b>For models:</b>   | AD-120, AD-120B, AD-120BBTDD-UK, AD-120C, AD-120CW, AD-120HY, AD-125, AD-125HRS, AD-125-SOFT, AD-21W, AD-45BBT, AD-48, AD-48B, AD-48BDD, AD-48C, AD-48D, AD-48DD, AD-48HY, AD-48W, AD-50S, AD-50S-SOFT, AD-64, AD-64B, AD-64BBT, AD-64BDD, AD-64BTDD, AD-64C, AD-64CW, AD-64D, AD-64DD, AD-64HY, AD-72, AD-72W, AD-90, AD-90BA, AD-90BBT, AD-90BDD, AD-90DD, BME6-05, BME7-05, BME7-10, BME9-05, BME9-05AD, BME9-05PLUS, BME9-05V-T, BME9-10, BME9-10AD, BME9-10PLUS, BME9-10V-T, CO-110... (Other models you can see in the webshop) |                 |                                  |

|  |   |                 |                     |
|--|---|-----------------|---------------------|
| <p>TECASA</p> <p>control thermostats</p>   |   |                 |                     |
|  |   |                 |                     |
| <b>GEV No.</b>   | 376058  | <b>Ref. No.</b> | 12024549<br>X153110 |
| <b>description</b>   | thermostat t.max. 310°C temperature range 50-310°C 1-pole 16A probe ø 3mm probe L 160mm capillary pipe 850mm capillary pipe isolated 700mm shaft ø 6x4.6mm  |                 |                     |
| <b>For models:</b>   | BME6-05, CE6-41, CE7-41, CE7-41Q, CE9-41, CE9-41AD, CE9-41PLUS, CGE6-41, CGE7-227, CGE7-41, CGE7-41H, CGE9-11, CGE9-41, CGE9-41AD, CGE9-41PLUS, CMF6-05, FTE6-05L, FTE6-05R, FTE6-10L, FTE6-10L+R, FTE6-10R, FTE7-05, FTE7-05L, FTE7-05R, FTE7-10, FTE7-10L, FTE7-10L+R, FTE7-10R, FTE9-05L, FTE9-05L-AD, FTE9-05PLUS-CL, FTE9-05PLUS-CR, FTE9-05PLUS-L, FTE9-05PLUS-R, FTE9-05R, FTE9-05R-AD, FTE9-10L, FTE9-10L+R, FTE9-10L+R-AD, FTE9-10L-AD, FTE9-10PLUS-CL, FTE9-10PLUS-CLR, FTE9-10PLUS-CR, FTE9-10PLUS-L, FTE9-10PLUS-LR, FTE9-10PLUS-R, FTE9-10R, FTE9-10R-AD, FTEC6-05L, FTEC6-10L...(Other models you can see in the webshop) |                 |                     |

|  |  |                 |                                    |
|--|--|-----------------|------------------------------------|
|  |  |                 |                                    |
| <b>GEV No.</b>   | 376078   | <b>Ref. No.</b> | 12038157<br>12135898<br>DO1DG11154 |
| <b>description</b>   | thermostat switch-off temp. 180°C 2-pole 16A probe ø 6mm probe L 59mm capillary pipe 2000mm capillary pipe isolatedmm shaft ømm 240V |                 |                                    |
| <b>For models:</b>   | SF-13, SF-8, SR-10MP-PSM, SR-13MP-PSM, SR-32MP-PSM   |                 |                                    |

|   |   |                 |                        |
|---|---|-----------------|------------------------|
|  |   |                 |                        |
| <b>GEV No.</b>  | 375448  | <b>Ref. No.</b> | 12034068<br>6021350005 |
| <b>description</b>  | thermostat t.max. 85°C temperature range 30-90°C 1-pole 1NO 16A probe ø 6mm probe L 90mm capillary pipe 2000mm capillary pipe isolated 1950mm gland nut shaft ø 6x4.6mm shaft L 23mm shaft position upper rotation 270° probe material SS |                 |                        |
| <b>For models:</b>  | AC-120, AC-180, CCF-10, CCF-10Cl, CCF-20, CCF-20Cl, CCF-40, CCF-40Cl  |                 |                        |

|  |   |                 |          |
|--|---|-----------------|----------|
|  |   |                 |          |
| <b>GEV No.</b>   | 376074  | <b>Ref. No.</b> | 12044749 |
| <b>description</b>   | thermostat switch-off temp. 290°C 1-pole 1NO 20A probe ø 6mm probe L 52mm capillary pipe 1500mm capillary pipe isolated 1300mm gland nut starting temperature 245°C probe SS  |                 |          |
| <b>For models:</b>   | FE-18, FE-25, FE-4, FE-6, FE6-05TE, FE6-10TE, FE-8, MG7-10BM, MG9-10BM, MG9-10BMS, MG9-10PLUS-BM, MG9-10PLUS-BMS, MG9-15BM, MG9-15BM316, MG9-15BMS, MG9-15PLUS-BM, MG9-15PLUS-BMS, MPG9-10BM, MPG9-10BMS, MPG9-15BM, MPG9-15BMS |                 |          |



## Зип-Общепит

K50 series

various

safety thermostats



|                    |   |                 |                        |
|--------------------|---|-----------------|------------------------|
| <b>GEV No.</b>     | 390798  | <b>Ref. No.</b> | 12032244<br>GR51000028 |
| <b>description</b> | safety thermostat switch-off temp. 235°C 1-pole 1CO probe ø 6mm probe L 63mm capillary pipe 1600mm capillary pipe isolated 80mm |                 |                        |
| <b>For models:</b> | PE-18-100, PE-18-120  |                 |                        |

## refrigeration thermostats

DANFOSS

control thermostats



|                    |   |                 |            |
|--------------------|---|-----------------|------------|
| <b>GEV No.</b>     | 390677  | <b>Ref. No.</b> | 6021350023 |
| <b>description</b> | thermostat type 077B0028 capillary pipe 1200mm temperature range -4,5 up to +10,5°C probe ømm probe Lmm |                 |            |
| <b>For models:</b> | BFP-100A, BFP-100I, BFP-150A, BFP-150I, BFP-200A, BFP-200I, BFP-250A, BFP-250I, BFP-300I                |                 |            |

RANCO

K22 series



|                    |   |                 |  |
|--------------------|---|-----------------|--|
| <b>GEV No.</b>     | 390524  | <b>Ref. No.</b> | 12033335<br>12033350<br>BR00023004<br>BR00023591 |
| <b>description</b> | thermostat RANCO type K22L1082 probe ømm probe Lmm capillary pipe 2000mm temperature range -22 up to -3°C |                 |  |

vsezip.ru

+7(812)987-08-81



|                    |  |                 |                        |
|--------------------|--|-----------------|------------------------|
| <b>GEV No.</b>     | 390427 <sup>1</sup>                                  | <b>Ref. No.</b> | 12035536<br>6021350009 |
| <b>description</b> | thermostat RANCO type K50L3389 capillary pipe 1200mm |                 |                        |
| <b>For models:</b> | BFP-150, BFP-200, BFP-250, BFP-300                   |                 |                        |

<sup>1</sup>incl. knob

## accessories

probe clips

miscellaneous



|                    |   |                 |                     |
|--------------------|---|-----------------|---------------------|
| <b>GEV No.</b>     | 550770  | <b>Ref. No.</b> | 12011614<br>R662630 |
| <b>description</b> | probe clip for combi-steamer  |                 |                     |
| <b>For models:</b> | HCG-10-11, HCG-10-21, HCG-20-11, HCG-20-21, HCG-2-10-11, HCG-2-20-11, HCG-6-11, HME-10-11, HME-10-21, HME-20-11, HME-20-21, HME-2-10-11, HME-2-20-11, HME-6-11, HMG-10-11, HMG-10-11UL, HMG-10-21, HMG-10-21UL, HMG-20-11, HMG-2-10-11, HMG-6-11, HMI-10-11, HMI-10-11UL, HMI-10-21, HMI-10-21UL, HMI-2-10-11, HMI-6-11, HMI-6-11UL, HMM-10-11, HMM-10-11UL, HMM-10-21, HMM-10-21UL, HMM-20-11, HMM-20-11UL, HMM-20-21, HMM-20-21UL, HMM-2-10-11, HMM-40-11-USMC, HMM-6-11, HMM-6-11UL, HMP-10-11, HMP-10-21, HMP-20-11, HMP-20-21, HMP-2-10-11, HMP-6-11, HVG-10-11, HVG-10-11UL, HVG-10-21, HVG-10-21UL...(Other models you can see in the webshop) |                 |                     |

## gland nut accessories

ducts



|                    |  |                 |                     |
|--------------------|--|-----------------|---------------------|
| <b>GEV No.</b>     | 691731   | <b>Ref. No.</b> | 12020538<br>X166113 |
| <b>description</b> | duct ET M14x1 IT M9x1                          |                 |                     |
| <b>For models:</b> | FE-710, FE-720, FE-920, FG-710, FG-720, FG-920 |                 |                     |







3 in 1 Общепит switches and momentary switches

vsezip.ru (812) 987-08-81

plunger sockets

|  |  |                 |                     |
|--|--|-----------------|---------------------|
|  <p>1</p> |  |                 |                     |
| <b>GEV No.</b>   | 505207   | <b>Ref. No.</b> | 12022413<br>Z263002 |
| <b>description</b>   | thermowell thread M12x1.75 IT ET M12x1.75 ID ø 8mm L 95mm SS/brass single ø 10mm   |                 |                     |
| <b>For models:</b>   | ECO-120, ECO-1200, ECO-120B, ECO-160, ECO-160D, ECO-160I, ECO-200, ECO-200D, ECO-200H, ECO-200HD, ECO-200HI, ECO-200I, ECO-2700D, ECO-2700I, ECO-280D, ECO-280I, ECO-370D, ECO-370I, ECO-4000D, ECO-4000I, ECO-460D, ECO-460I, ECO-550D, ECO-550I, ECO-6000D, ECO-6000I, FI-100, FI-100AR, FI-100B, FI-100BBT-UK, FI-120, FI-1200, FI-120AR+DD, FI-120B, FI-120C, FI-120HY-CLINIC, FI-120W, FI-160, FI-160AR, FI-160D, FI-160I, FI-200, FI-200AR, FI-200D, FI-200H, FI-200HD, FI-200HI, FI-200I, FI-200W, FI-200WL...(Other models you can see in the webshop) |                 |                     |



connecting bows

|  |  |                 |                     |
|--|--|-----------------|---------------------|
|  <p>1</p> |  |                 |                     |
| <b>GEV No.</b>   | 691005   | <b>Ref. No.</b> | 12001816<br>X313001 |
| <b>description</b>   | support bracket for thermostat and switch  |                 |                     |
| <b>For models:</b>   | BME7-05, BME7-10, BME9-05, BME9-05V-T, BME9-10, BME9-10V-T, FE7-05-1C, FE7-05-2C, FE-710, FE7-10-2C, FE7-10-4C, FE-720, FE9-05, FE9-05-1C, FE9-05-2C, FE9-05S, FE9-05S-1C, FE9-05S-2C, FE9-05USMC, FE9-10, FE9-10-2C, FE9-10-4C, FG7-05-1C, FG7-05-2C, FG-710, FG7-10-2C, FG7-104C, FG7-10-4C, FG-720, FG9-05, FG9-05-1C, FG9-05-2C, FG9-05S, FG9-05S-1C, FG9-05S-2C, FG9-10, FG9-10-2C, FG9-10-4C, FGCL9-05, FI-120, FI-180, FI-250, FTE7-05, FTE7-05L, FTE7-05R, FTE7-10, FTE7-10L, FTE7-10L+R, FTE7-10R, FTE9-05L...(Other models you can see in the webshop) |                 |                     |

miscellaneous

|  |  |                 |                     |
|--|--|-----------------|---------------------|
|  <p>1</p> |  |                 |                     |
| <b>GEV No.</b>   | 510214   | <b>Ref. No.</b> | 12016656<br>X163015 |
| <b>description</b>   | union screw thread M9x1 hole ø 3.7mm L 12mm                  |                 |                     |
| <b>For models:</b>   | FE9-05, FE9-05S, FE9-05USMC, FE9-10, FG9-05, FG9-05S, FG9-10 |                 |                     |

rocker/momentary rocker switches

|  |  |                 |                          |
|--|--|-----------------|--------------------------|
|  <p>1</p> |  |                 |                          |
| <b>GEV No.</b>   | 301066   | <b>Ref. No.</b> | 12016888<br>R743008      |
| <b>description</b>   | rocker switch mounting measurements 19x13mm black 2NO 250V 6A 0-I connection male faston 4.8mm ambient temperature max. 85°C protection IP40   |                 |                          |
| <b>For models:</b>   | HGV-10-11, HGV-20-11, HME-20-11, HMG-10-11, HMG-10-11UL, HMG-10-21, HMG-10-21UL, HMG-20-11, HMG-2-10-11, HMG-6-11, HMM-10-11, HMM-10-11UL, HMM-10-21, HMM-10-21UL, HMM-20-11, HMM-20-11UL, HMM-20-21, HMM-20-21UL, HMM-2-10-11, HMM-40-11-USMC, HMM-6-11, HMM-6-11UL, HMP-20-11, HVG-10-11, HVG-10-11UL, HVG-10-21, HVG-10-21UL, HVG-20-11, HVG-20-21, HVG-2-10-11, HVG-2-20-21, MFHMM-20-11, MFHVG-10-11, MFHVG-10-21 |                 |                          |
| <b>accessories for</b>   | 301066   |                 |                          |
|  |  <p>GEV No.</p>   | 301064          | <p>Ref. No.</p> <p>—</p> |
|  | protective cover for pressure switch external size 23.4x17.4mm internal size 19x13mm H 7.5mm clear mounting measurementsmm   |                 |                          |

28x13.5mm

|   |   |                 |                    |
|---|---|-----------------|--------------------|
|  <p>1</p> |   |                 |                    |
| <b>GEV No.</b>  | 347873  | <b>Ref. No.</b> | 12024372<br>Z20307 |
| <b>description</b>  | momentary rocker switch mounting measurements 27.4x12.4mm black 1NO 250V 16A connection male faston 6.3mm ambient temperature max. 85°C protection IP40 |                 |                    |
| <b>For models:</b>  | FI-48D, FI-64D, LVC-15, LVC-15D, LVC-21, LVC-21D  |                 |                    |

30x11mm

|  |   |                 |                     |
|--|---|-----------------|---------------------|
|  <p>1</p> |   |                 |                     |
| <b>GEV No.</b>   | 345489  | <b>Ref. No.</b> | 12023616<br>Z403033 |
| <b>description</b>   | momentary rocker switch mounting measurements 30x11mm orange 1NO 250V 16A connection male faston 6.3mm ambient temperature max. 90°C protection IP40  |                 |                     |
| <b>For models:</b>   | FI-48, FI-48AR, FI-48B, FI-48B-BT-UK, FI-48C, FI-48D, FI-48HY-CLINIC, FI-48W, FI-64, FI-64AR, FI-64B, FI-64B-BT-UK, FI-64C, FI-64D, FI-64HY-CLINIC, FI-64W, LVC-12, LVC-15, LVC-15D, LVC-21, LVC-21B, LVC-21C, LVC-21D, LVC-21W, LVR-14, LVR-14D, LVR-20, LVR-20D |                 |                     |

electric components



Зип Общепит



vsezip.ru



+7(812)987-08-81

|   |   |                 |                        |
|---|---|-----------------|------------------------|
|  |   |                 |                        |
| <b>1</b>  |   |                 |                        |
| <b>GEV No.</b>  | 301011  | <b>Ref. No.</b> | 12037353<br>6021130002 |
| <b>description</b>  | rocker switch mounting measurements 30x11mm orange 1NC / indicator light 250V 16A 0-I connection male faston 6.3mm ambient temperature max. 85/125°C protection IP40  |                 |                        |
| <b>For models:</b>  | AEP-1402, AEP-1602, AEP-2103, AEP-701, AEP-801, AEP-802, AF-1402-MIX, AF-1403-C, AF-1403-P, AF-1404-C, AF-1404-P, AF-1602-MIX, AF-1603-C, AF-1603-P, AF-1604-C, AF-1604-P, AF-2104-C, AF-2104-P, AF-2105-C, AF-2105-P, AF-2106-C, AF-2106-P, AF-702-C, AF-702-P, AF-802-C, AF-802-P, AFN-1402, AFN-1403, AFN-1404, AFN-1602, AFN-1603, AFN-1604, AFN-701, AFN-702, AFN-801, AFN-802, AFP-1402, AFP-1403, AFP-1404, AFP-1404-USMC, AFP-1602, AFP-1602-2, AFP-1603, AFP-1603-2, AFP-1604, AFP-2103, AFP-2104, AFP-2105, AFP-2106, AFP-701...(Other models you can see in the webshop) |                 |                        |

|   |   |                 |                        |
|---|---|-----------------|------------------------|
|  |   |                 |                        |
| <b>1</b>  |   |                 |                        |
| <b>GEV No.</b>  | 346787  | <b>Ref. No.</b> | 12037702<br>6003010074 |
| <b>description</b>  | dummy element external size 30x11mm black   |                 |                        |
| <b>For models:</b>  | AF-1402-MIX, AF-1403-C, AF-1403-P, AF-1404-C, AF-1404-P, AF-1602-MIX, AF-1603-C, AF-1603-P, AF-1604-C, AF-1604-P, AF-2104-C, AF-2104-P, AF-2105-C, AF-2105-P, AF-2106-C, AF-2106-P, AF-702-C, AF-702-P, AF-802-C, AF-802-P, AFN-1402, AFN-1403, AFN-1404, AFN-1602, AFN-1603, AFN-1604, AFN-702, AFN-801, AFN-802, MFP-135-B, MFP-180-B, MFP-225-B, MFP-270-B |                 |                        |



## 30x22mm

|   |  |                 |  |
|---|--|-----------------|--|
|  |  |                 |  |
| <b>1</b>  |  |                 |  |
| <b>GEV No.</b>  | 301002   | <b>Ref. No.</b> | 12024356<br>12035989<br>12036781<br>12037293<br>6001507003<br>6021130001<br>Z203003<br>Z203033<br>ZAINTE0009 |
| <b>description</b>  | rocker switch mounting measurements 30x22mm orange 2NO 250V 16A illuminated 0-I connection male faston 6.3mm ambient temperature max. 85/125°C protection IP65   |                 |  |
| <b>For models:</b>  | AC-120, AC-180, AEP-1402, AEP-1403, AEP-1404, AEP-1602, AEP-1603, AEP-1604, AEP-2103, AEP-701, AEP-702, AEP-801, AEP-802, AF-1402-MIX, AF-1403-C, AF-1403-P, AF-1404-C, AF-1404-P, AF-1602-MIX, AF-1603-C, AF-1603-P, AF-1604-C, AF-1604-P, AF-2104-C, AF-2104-P, AF-2105-C, AF-2105-P, AF-2106-C, AF-2106-P, AF-702-C, AF-702-P, AF-802-C, AF-802-P, AFN-1402, AFN-1403, AFN-1404, AFN-1602, AFN-1603, AFN-1604, AFN-701, AFN-702, AFN-801, AFN-802, AFP-1402, AFP-1402-FORZ, AFP-1402-MIX, AFP-1403, AFP-1403-C, AFP-1403-FORZ, AFP-1403-P...(Other models you can see in the webshop) |                 |  |
| <b>accessories for</b>  | 301002   |                 |  |
|  | <b>GEV No.</b>   | 301036          | <b>Ref. No.</b> —  |
|   | protective cover internal size 30x22mm for rocker switch mounting measurementsmm   |                 |  |

|   |  |                 |                                |
|---|--|-----------------|--------------------------------|
|  |  |                 |                                |
| <b>1</b>  |  |                 |                                |
| <b>GEV No.</b>  | 345491   | <b>Ref. No.</b> | 12039115<br>Z213001<br>Z213033 |
| <b>description</b>  | momentary rocker switch mounting measurements 30x22mm orange 1NO/indicator light 250V 16A connection male faston 6.3mm ambient temperature max. 100/55°C protection IP40   |                 |                                |
| <b>For models:</b>  | EASY-500, EASY-500B, EASY-500DD, EASY-500HP, EASY-500HPWBDD, FI-48, FI-48AR, FI-48B, FI-48B-BT-UK, FI-48C, FI-48D, FI-48HY-CLINIC, FI-48W, FI-64, FI-64AR, FI-64B, FI-64B-BT-UK, FI-64C, FI-64D, FI-64HY-CLINIC, FI-64W, FI-72, GA-20, GA-20D, GA-40, GA-40D, HCG-10-11, HCG-10-21, HCG-20-11, HCG-20-21, HCG-2-10-11, HCG-2-20-11, HCG-6-11, HCG-10-11, HCG-20-11, HCG-6-11, HGV-10-11, HGV-20-11, HVG-10-11, HVG-10-11UL, HVG-10-21, HVG-10-21UL, HVG-20-11, HVG-20-21, HVG-2-10-11, HVG-2-20-21, LAC-10MP, LAC-10MPP, LAC-14MP, LAC-14MPP...(Other models you can see in the webshop) |                 |                                |
| <b>accessories for</b>  | 345491   |                 |                                |
|  | <b>GEV No.</b>   | 301036          | <b>Ref. No.</b> —              |
|   | protective cover internal size 30x22mm for rocker switch mounting measurementsmm   |                 |                                |

|   |   |                 |                     |
|---|---|-----------------|---------------------|
|  |   |                 |                     |
| <b>1</b>  |   |                 |                     |
| <b>GEV No.</b>  | 346689  | <b>Ref. No.</b> | 12024213<br>Z203080 |
| <b>description</b>  | momentary rocker switch mounting measurements 30x22mm orange 1NO/indicator light 230V 16A illuminated connection male faston 6.3mm ambient temperature max. 125°C protection IP40   |                 |                     |
| <b>For models:</b>  | FI-48, FI-48AR, FI-48B, FI-48B-BT-UK, FI-48C, FI-48D, FI-48HY-CLINIC, FI-48W, FI-64, FI-64AR, FI-64B, FI-64B-BT-UK, FI-64C, FI-64D, FI-64HY-CLINIC, FI-64W, FI-72, FI-72AR, FI-72W, GA-20, GA-40, LVC-15, LVC-15D, LVC-21, LVC-21B, LVC-21C, LVC-21D, LVC-21W |                 |                     |

|   |  |                 |                     |
|---|--|-----------------|---------------------|
|  |  |                 |                     |
| <b>1</b>  |  |                 |                     |
| <b>GEV No.</b>  | 301061   | <b>Ref. No.</b> | 12025209<br>Z203071 |
| <b>description</b>  | rocker switch mounting measurements 30x22mm orange 2NO 250V 16A illuminated connection male faston 6.3mm ambient temperature max. 125/55°C protection IP40 |                 |                     |
| <b>For models:</b>  | FI-30, FI-30AR, FI-30AR+DD, FI-30-UK, FI-60DD, LVC-12, LVC-15, LVC-21  |                 |                     |

|   |   |                 |                      |
|---|---|-----------------|----------------------|
|  |   |                 |                      |
| <b>1</b>  |   |                 |                      |
| <b>GEV No.</b>  | 346377  | <b>Ref. No.</b> | 12037317<br>12049461 |
| <b>description</b>  | rocker switch mounting measurements 30x22mm black 2CO 230V 16A 0-I connection male faston 6.3mm ambient temperature max. 125/55°C protection IP40 |                 |                      |
| <b>accessories for</b>  | 346377  |                 |                      |
|  | <b>GEV No.</b>  | 301036          | <b>Ref. No.</b> —    |
|   | protective cover internal size 30x22mm for rocker switch mounting measurementsmm  |                 |                      |



Зип Общепит

vsezip.ru

87(012)987-08-81

|   |   |                 |                     |
|---|---|-----------------|---------------------|
|  |   |                 |                     |
| 1   |   |                 |                     |
| <b>GEV No.</b>  | 345423  | <b>Ref. No.</b> | 12020632<br>X343002 |
| <b>description</b>  | momentary rocker switch mounting measurement: 30x22mm black 2CO 230V 16A with neutral position arrow up/down connection male faston 6.3mm ambient temperature max. 125/55°C protection IP40 |                 |                     |
| <b>For models:</b>  | SBE9-10IM, SBE9-10IMS, SBE9-10M, SBE9-10MS, SBE9-15IM, SBE9-15IMS, SBG9-10IM, SBG9-10IMS, SBG9-10M, SBG9-10MS, SBG9-15IM, SBG9-15IMS  |                 |                     |

|   |   |                 |                     |
|---|---|-----------------|---------------------|
|  |   |                 |                     |
| 1   |   |                 |                     |
| <b>GEV No.</b>  | 345689 <sup>1</sup>   | <b>Ref. No.</b> | 12020974<br>R723027 |
| <b>description</b>  | momentary rocker switch mounting measurements 30x22mm orange 1NO 250V 16A illuminated, lamp 12 V connection male faston 6.3mm ambient temperature max. 85/125°C protection IP40 |                 |                     |
| <b>For models:</b>  | HCG-10-11, HCG-10-21, HCG-20-11, HCG-2-10-11, HCG-6-11, HMG-10-11, HMG-10-11UL, HMG-10-21, HMG-10-21UL, HMG-20-11, HMG-2-10-11, HMG-6-11  |                 |                     |

<sup>1</sup>illuminated

|  |  |                 |                        |
|--|--|-----------------|------------------------|
|  |  |                 |                        |
| 1  |  |                 |                        |
| <b>GEV No.</b>   | 347092   | <b>Ref. No.</b> | 12035896<br>OSC0000107 |
| <b>description</b>   | rocker switch mounting measurements 30x22mm red/black 1CO/indicator light 250V 16A connection male faston 6.3mm ambient temperature max. 85°C protection IP65 with cover cap |                 |                        |

push/momentary push switches

19x13mm

|   |   |                 |                     |
|---|---|-----------------|---------------------|
|  |   |                 |                     |
| 1   |   |                 |                     |
| <b>GEV No.</b>  | 345690  | <b>Ref. No.</b> | 12016811<br>R663032 |
| <b>description</b>  | momentary push switch mounting measurements 19x13mm black 1NO 250V 16A connection male faston 4.8mm ambient temperature max. 105°C protection IP40  |                 |                     |
| <b>For models:</b>  | FF-35, HCG-10-11, HCG-10-21, HCG-20-11, HCG-20-21, HCG-2-10-11, HCG-2-20-11, HCG-6-11, HEI-10-11, HEI-20-11, HEI-6-11, HEM-10-11, HEM-20-11, HEM-6-11, HEP-10-11, HEP-20-11, HEP-6-11, HGC-10-11, HGC-20-11, HGC-6-11, HME-10-11, HME-10-21, HME-20-11, HME-20-21, HME-2-10-11, HME-2-20-11, HME-6-11, HMG-10-11, HMG-10-11UL, HMG-10-21, HMG-10-21UL, HMG-20-11, HMG-2-10-11, HMG-6-11, HMI-10-11, HMI-10-11UL, HMI-10-21, HMI-10-21UL, HMI-2-10-11, HMI-6-11, HMI-6-11UL, HMP-10-11, HMP-10-21, HMP-20-11, HMP-20-21, HMP-2-10-11, HMP-6-11 |                 |                     |

|   |  |                 |                     |
|---|--|-----------------|---------------------|
|  |  |                 |                     |
| 1   |  |                 |                     |
| <b>GEV No.</b>  | 301047 <sup>1</sup>  | <b>Ref. No.</b> | 12024373<br>Z853001 |
| <b>description</b>  | push switch mounting measurements 30x22mm green 2NO 250V 16A illuminated connection male faston 6.3mm ambient temperature max. 85°C protection IP40 latching |                 |                     |
| <b>For models:</b>  | FE-18, FE-25, FE-4, FE-6, FE-71-15, FE-8, FE-91-20, FI-300R, FI-650R, HCV-10-11, HCV-10-21, HCV-2-10-21  |                 |                     |

<sup>1</sup>illuminated

|   |  |                 |                        |
|---|--|-----------------|------------------------|
|  |  |                 |                        |
| 1   |  |                 |                        |
| <b>GEV No.</b>  | 348233   | <b>Ref. No.</b> | 12023927<br>T723009000 |
| <b>description</b>  | momentary push switch mounting ø 22mm black 1NO/1NC 250V 3A connection F2,8x0,5  |                 |                        |
| <b>For models:</b>  | ACE-061, ACE-101, AE-061, AE-101, APE-061, APE-101, APE-102, APE-201, APE-202, APG-061, APG-101, APG-102, APG-201, APG-202, CG9-31PLUS-D, CG9-31PLUS-I |                 |                        |

|   |  |                 |          |
|---|--|-----------------|----------|
|  |  |                 |          |
| 1   |  |                 |          |
| <b>GEV No.</b>  | 348220   | <b>Ref. No.</b> | 12115383 |
| <b>description</b>  | momentary push switch mounting ø 22mm silver 1NO/1NC/indicator light 220V 5A connection male faston 2.8mm round  |                 |          |
| <b>For models:</b>  | CO-350, CO-350-B, CO-350-B-DD, CO-350-COLD, CO-350-COLD-B, CO-350-COLD-B-DD, CO-350-COLD-DD, CO-350-DD, CO-400, CO-400-B, CO-400-B-DD, CO-400-COLD, CO-400-COLD-B, CO-400-COLD-B-DD, CO-400-COLD-DD, CO-400-DD, CO-400-SOFT, CO-500, CO-500B, CO-500BDD, CO-500DD, CO-501, CO-501B, CO-501BDD, CO-501DD, CO-501-SOFT |                 |          |

|   |  |                 |                     |
|---|--|-----------------|---------------------|
|  |  |                 |                     |
| 1   |  |                 |                     |
| <b>GEV No.</b>  | 346662   | <b>Ref. No.</b> | 12000066<br>X022108 |
| <b>description</b>  | protective cover internal size 30x55mm   |                 |                     |
| <b>For models:</b>  | SBE9-10I, SBE9-10IM, SBE9-10IMS, SBE9-10IS, SBE9-10M, SBE9-10MS, SBE9-15IM, SBE9-15IMS, SBE9-15M, SBE9-15MS, SBG9-10IM, SBG9-10IMS, SBG9-10M, SBG9-10MS, SBG9-15IM, SBG9-15IMS |                 |                     |



Зип Общепит

vsezip.ru

+7(812)987 08 81

ø25mm



1

|  |   |                 |                        |
|--|---|-----------------|------------------------|
| <b>GEV No.</b>   | 345039  | <b>Ref. No.</b> | 12036803<br>FX40100036 |
| <b>description</b>   | protective cover round ED ø 33mm external size 23mm internal size 21mm H 12mm clear mounting ø 25mm |                 |                        |
| <b>accessories for</b>   | 345039  |                 |                        |
|   | <b>GEV No.</b>  | 345001          | <b>Ref. No.</b> —      |
| momentary push switch mounting ø 25mm yellow 1NO/indicator light 250V 16A cover connection male faston 6.3mm ambient temperature max. 85°C protection IP65 |   |                 |                        |

1

|                    |  |                 |                     |
|--------------------|--|-----------------|---------------------|
| <b>GEV No.</b>     | 691005   | <b>Ref. No.</b> | 12001816<br>X313001 |
| <b>description</b> | support bracket for thermostat and switch  |                 |                     |
| <b>For models:</b> | BME7-05, BME7-10, BME9-05, BME9-05V-T, BME9-10, BME9-10V-T, FE7-05-1C, FE7-05-2C, FE-710, FE7-10-2C, FE7-10-4C, FE-720, FE9-05, FE9-05-1C, FE9-05-2C, FE9-05S, FE9-05S-1C, FE9-05S-2C, FE9-05USMC, FE9-10, FE9-10-2C, FE9-10-4C, FG7-05-1C, FG7-05-2C, FG-710, FG7-10-2C, FG7-104C, FG7-10-4C, FG-720, FG9-05, FG9-05-1C, FG9-05-2C, FG9-05S, FG9-05S-1C, FG9-05S-2C, FG9-10, FG9-10-2C, FG9-10-4C, FGCL9-05, FI-120, FI-180, FI-250, FTE7-05, FTE7-05L, FTE7-05R, FTE7-10, FTE7-10L, FTE7-10L+R, FTE7-10R, FTE9-05L...(Other models you can see in the webshop) |                 |                     |

## accessories

## fitting parts



1

|                    |  |                 |                     |
|--------------------|--|-----------------|---------------------|
| <b>GEV No.</b>     | 691716   | <b>Ref. No.</b> | 12013476<br>T093000 |
| <b>description</b> | mounting plate electric suitable for convection oven |                 |                     |
| <b>For models:</b> | HCG-20-11, HMG-20-11                                 |                 |                     |



1

|                    |  |                 |                     |
|--------------------|--|-----------------|---------------------|
| <b>GEV No.</b>     | 691717   | <b>Ref. No.</b> | 12012593<br>T083003 |
| <b>description</b> | mounting plate electric suitable for convection oven   |                 |                     |
| <b>For models:</b> | HCG-10-11, HCG-10-21, HCG-20-11, HCG-20-21, HCG-2-10-11, HCG-2-20-11, HCG-6-11, HGC-10-11, HGC-20-11, HGC-6-11 |                 |                     |



1

|                    |   |                 |                     |
|--------------------|---|-----------------|---------------------|
| <b>GEV No.</b>     | 401784  | <b>Ref. No.</b> | 12003412<br>X342608 |
| <b>description</b> | mounting plate for switch   |                 |                     |
| <b>For models:</b> | SBE9-10, SBE9-10I, SBE9-10IM, SBE9-10IMS, SBE9-10IS, SBE9-10M, SBE9-10MS, SBE9-10S, SBE9-15IM, SBE9-15IMS, SBE9-15M, SBE9-15MS, SBG9-10IM, SBG9-10IMS, SBG9-10M, SBG9-10MS, SBG9-15IM, SBG9-15IMS |                 |                     |



1

|                    |                           |                 |                     |
|--------------------|---------------------------|-----------------|---------------------|
| <b>GEV No.</b>     | 401785                    | <b>Ref. No.</b> | 12012103<br>S322613 |
| <b>description</b> | mounting plate for switch |                 |                     |
| <b>For models:</b> | MG7-10BM                  |                 |                     |

## microswitches

## lever actuated



1

|                    |   |                 |                       |
|--------------------|---|-----------------|-----------------------|
| <b>GEV No.</b>     | 345254  | <b>Ref. No.</b> | 12033747<br>GMP831613 |
| <b>description</b> | microswitch with lever 250V 16A 1CO connection male faston 6.3mm ambient temperature max. 120°C mounting distance 22mm actuating force: 60g lever length 58mm |                 |                       |

## roller-lever actuated

## microswitches



1

|                    |  |                 |                        |
|--------------------|--|-----------------|------------------------|
| <b>GEV No.</b>     | 345216   | <b>Ref. No.</b> | 12035139<br>RT30160101 |
| <b>description</b> | microswitch 250V 16A 1CO connection male faston 6.3mm ambient temperature max. 125°C mounting distance 22mm with handle with a switch blue/black |                 |                        |



1

|                    |  |                 |                        |
|--------------------|--|-----------------|------------------------|
| <b>GEV No.</b>     | 347949   | <b>Ref. No.</b> | 12035191<br>RT30160102 |
| <b>description</b> | microswitch with handle with a switch 250V 0.1A 1NC connection male faston 6.3mm L 21mm L1 12mm mounting distance 24mm white |                 |                        |



Зип Общепит

vsezip.ru

(812) 987-08-81

electric components

|   |   |                 |                     |
|---|---|-----------------|---------------------|
|  |   |                 |                     |
| 1   |   |                 |                     |
| <b>GEV No.</b>  | 345250  | <b>Ref. No.</b> | 12025193<br>R010534 |
| <b>description</b>  | microswitch with handle with a switch 250V 16A 1CO connection male faston 6.3mm L 27mm L1 36mm ambient temperature max. 125°C mounting distance 22mm type RL6-1-FGE-P12-5-L actuating force: 90g  |                 |                     |
| <b>For models:</b>  | ACE-061, ACE-101, ACE-102, ACE-201, ACE-202, ACG-061, ACG-101, ACG-102, ACG-201, ACG-202, AE-061, AE-061W, AE-101, AE-101W, AE-102, AE-102W, AE-201, AE-202, AG-061, AG-061W, AG-101, AG-101W, AG-102, AG-102W, AG-201, AG-202, APE-061, APE-061W, APE-101, APE-101W, APE-102, APE-102W, APE-201, APE-202, APG-061, APG-061W, APG-101, APG-101W, APG-102, APG-102W, APG-201, APG-202, COE-061, COE-101, COE-102, COE-201, COE-202, FE-710, FE-720, FE-905...(Other models you can see in the webshop) |                 |                     |

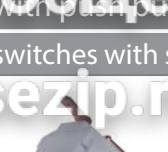
|  |   |                 |                        |
|--|---|-----------------|------------------------|
|  |   |                 |                        |
| with push button   |   |                 |                        |
| switches with snap-fit   |   |                 |                        |
| 1  |   |                 |                        |
| <b>GEV No.</b>   | 346724  | <b>Ref. No.</b> | 12037396<br>6021130008 |
| <b>description</b>   | microswitch with push button 250V 0.25A 1NO connection male faston 4.8mm L 25x12.5mm ambient temperature max. 85°C actuating force: 900g  |                 |                        |
| <b>For models:</b>   | AEP-1402, AEP-1602, AEP-2103, AEP-701, AEP-801, AEP-802, AF-1402-MIX, AF-1403-C, AF-1403-P, AF-1404-C, AF-1404-P, AF-1602-MIX, AF-1603-C, AF-1603-P, AF-1604-C, AF-1604-P, AF-2104-C, AF-2104-P, AF-2105-C, AF-2105-P, AF-2106-C, AF-2106-P, AF-702-C, AF-702-P, AF-802-C, AF-802-P, AFN-1402, AFN-1403, AFN-1404, AFN-1602, AFN-1603, AFN-1604, AFN-702, AFN-801, AFN-802, AFP-1402, AFP-1403, AFP-1404, AFP-1404-USMC, AFP-1602, AFP-1602-2, AFP-1603, AFP-1603-2, AFP-1604, AFP-2103, AFP-2104, AFP-2105, AFP-2106, AFP-701, AFP-702...(Other models you can see in the webshop) |                 |                        |

|   |  |                 |                        |
|---|--|-----------------|------------------------|
| pin-plunger actuated  |  |                 |                        |
|  |  |                 |                        |
| 1   |  |                 |                        |
| <b>GEV No.</b>  | 345105   | <b>Ref. No.</b> | 12037903<br>BR00023055 |
| <b>description</b>  | microswitch with plunger 250V 16A 1CO connection male faston 6.3mm L 28mm ambient temperature max. 125°C mounting distance 22mm type SM-51 actuating force: 280g black |                 |                        |

|   |   |                 |  |
|---|---|-----------------|--|
|  |   |                 |  |
| 1   |   |                 |  |
| <b>GEV No.</b>  | 348207  | <b>Ref. No.</b> | 12036888<br>12037050<br>6021130032<br>6021130041 |
| <b>description</b>  | switch 250V 5A 1CO connection F4.8 L 27.5mm type 5E4 25T85 actuating force: 150g  |                 |  |
| <b>For models:</b>  | ADAEP-1602, ADAEP-801, ADAFN-1602, ADAFN-801, ADAFP-1602, ADAFP-801, AEF-801AD, AEF-802AD, AEP-1402, AEP-1602, AEP-1602AD, AEP-1603AD, AEP-1604AD, AEP-2103, AEP-701, AEP-801, AEP-802, AF-1402-MIX, AF-1403-C, AF-1403-P, AF-1404-C, AF-1404-P, AF-1602-MIX, AF-1603-C, AF-1603-P, AF-1604-C, AF-1604-P, AF-2104-C, AF-2104-P, AF-2105-C, AF-2105-P, AF-2106-C, AF-2106-P, AF-702-C, AF-702-P, AF-802-C, AF-802-P, AFN-1402, AFN-1403, AFN-1404, AFN-1602, AFN-1603, AFN-1604, AFN-702, AFN-801, AFN-802, AFP-1402, AFP-1403, AFP-1404...(Other models you can see in the webshop) |                 |  |

|   |   |                 |                       |
|---|---|-----------------|-----------------------|
| M10   |   |                 |                       |
|  |   |                 |                       |
| 1   |   |                 |                       |
| <b>GEV No.</b>  | 345032  | <b>Ref. No.</b> | 12040850<br>GMP831318 |
| <b>description</b>  | microswitch with plunger thread M10x1 thread L 12mm 250V 16A 1CO connection male faston 6.3mm stroke 7mm mounting distance 22mm L 28mm ambient temperature max. 125°C type SP9603 actuating force: 180g   |                 |                       |
| <b>For models:</b>  | FE-18, FE-25, FE-4, FE-6, FE-8, SBE7-10, SBE9-10, SBE9-10I, SBE9-10IM, SBE9-10IMS, SBE9-10IS, SBE9-10M, SBE9-10MS, SBE9-10PLUS-I, SBE9-10PLUS-IM, SBE9-10PLUS-SI, SBE9-10PLUS-SIM, SBE9-10S, SBE9-15IM, SBE9-15IMS, SBE9-15M, SBE9-15MS, SBE9-15PLUS-IM, SBE9-15PLUS-SIM, SBG7-10, SBG9-10, SBG9-10I, SBG9-10IM, SBG9-10IMS, SBG9-10IS, SBG9-10M, SBG9-10MS, SBG9-10PLUS-I, SBG9-10PLUS-IM, SBG9-10PLUS-SI, SBG9-10PLUS-SIM, SBG9-10S, SBG9-15IM, SBG9-15IMS, SBG9-15PLUS-IM, SBG9-15PLUS-SIM |                 |                       |

|   |                          |                 |         |
|---|--------------------------|-----------------|---------|
| accessories   |                          |                 |         |
|  |                          |                 |         |
| 1   |                          |                 |         |
| <b>GEV No.</b>  | 505166                   | <b>Ref. No.</b> | Z653010 |
| <b>description</b>  | actuator for microswitch |                 |         |

|   |  |                 |                     |
|---|--|-----------------|---------------------|
|  |  |                 |                     |
| 1   |  |                 |                     |
| <b>GEV No.</b>  | 691863   | <b>Ref. No.</b> | 12020591<br>X153007 |
| <b>description</b>  | bar L 200mm ø 8mm  |                 |                     |
| <b>For models:</b>  | SBE7-10, SBE9-10, SBE9-10I, SBE9-10IM, SBE9-10IMS, SBE9-10IS, SBE9-10M, SBE9-10MS, SBE9-10S, SBE9-15IM, SBE9-15IMS, SBE9-15M, SBE9-15MS, SBE9-15PLUS-IM, SBE9-15PLUS-SIM |                 |                     |



Зип Общепит

vsezip.ru

7(812)987-08-81



|                    |   |                 |                     |
|--------------------|---|-----------------|---------------------|
| <b>GEV No.</b>     | 691077  | <b>Ref. No.</b> | 12009985<br>R010535 |
| <b>description</b> | insulation L 45mm for microswitch W 30mm thickness 1mm  |                 |                     |
| <b>For models:</b> | ACE-061, ACE-101, ACE-102, ACE-201, ACE-202, ACG-061, ACG-101, ACG-102, ACG-201, ACG-202, AE-061, AE-061W, AE-101, AE-101W, AE-102, AE-102W, AE-201, AE-202, AG-061, AG-061W, AG-101, AG-101W, AG-102, AG-102W, AG-201, AG-202, APE-061, APE-061W, APE-101, APE-101W, APE-102, APE-102W, APE-201, APE-202, APG-061, APG-061W, APG-101, APG-101W, APG-102, APG-102W, APG-201, APG-202, COE-061, COE-101, COE-102, COE-201, COE-202, FE-710, FE-720, FE9-05...(Other models you can see in the webshop) |                 |                     |



|                    |   |                 |                     |
|--------------------|---|-----------------|---------------------|
| <b>GEV No.</b>     | 691079  | <b>Ref. No.</b> | 12020976<br>R010533 |
| <b>description</b> | pressure pin for microswitch  |                 |                     |
| <b>For models:</b> | FE-710, FE-720, FE9-05, FE9-05S, FE9-05USMC, FE9-10, FE-920, HCG-10-11, HCG-10-21, HCG-20-11, HCG-2-10-11, HCG-6-11, HCV-10-11, HCV-10-21, HCV-2-10-21, HE-10-11, HE-10-21, HE-2-10-11, HE-6-11, HG-10-21, HG-2-10-11, HME-10-11, HME-10-21, HME-20-11, HME-20-21, HME-2-10-11, HME-6-11, HMG-10-11, HMG-10-11UL, HMG-10-21, HMG-10-21UL, HMG-20-11, HMG-2-10-11, HMG-6-11, HMI-10-11, HMI-10-11UL, HMI-10-21, HMI-10-21UL, HMI-2-10-11, HMI-6-11, HMI-6-11UL, HMM-10-11, HMM-10-11UL, HMM-10-21, HMM-10-21UL, HMM-20-11, HMM-20-11UL, HMM-20-21, HMM-2-10-11, HMM-6-11...(Other models you can see in the webshop) |                 |                     |

system switches (ROLD)



|                    |   |                 |                     |
|--------------------|---|-----------------|---------------------|
| <b>GEV No.</b>     | 346499  | <b>Ref. No.</b> | 12009331<br>X022107 |
| <b>description</b> | element holder mounting measurements 28.5x52.6mm black two-fold element holder  |                 |                     |
| <b>For models:</b> | SBE9-10, SBE9-10I, SBE9-10IM, SBE9-10IM-AD, SBE9-10IM-AD-S, SBE9-10IMS, SBE9-10IS, SBE9-10M, SBE9-10MS, SBE9-10PLUS-IM, SBE9-10PLUS-SIM, SBE9-10S, SBE9-15IM, SBE9-15IM-AD, SBE9-15IM-AD-S, SBE9-15IMS, SBE9-15M, SBE9-15MS, SBE9-15PLUS-IM, SBE9-15PLUS-SIM, SBG9-10IM, SBG9-10IM-AD, SBG9-10IM-AD-S, SBG9-10IMS, SBG9-10M, SBG9-10MS, SBG9-10PLUS-IM, SBG9-10PLUS-SIM, SBG9-15IM, SBG9-15IM-AD, SBG9-15IM-AD-S, SBG9-15IMS, SBG9-15PLUS-IM, SBG9-15PLUS-SIM |                 |                     |



|                    |   |                 |                     |
|--------------------|---|-----------------|---------------------|
| <b>GEV No.</b>     | 345650  | <b>Ref. No.</b> | 12024804<br>X022109 |
| <b>description</b> | momentary switch unit 2CO 250V 16A connection male faston 6.3mm   |                 |                     |
| <b>For models:</b> | SBE9-10, SBE9-10I, SBE9-10IM, SBE9-10IM-AD, SBE9-10IM-AD-S, SBE9-10IMS, SBE9-10IS, SBE9-10M, SBE9-10MS, SBE9-10PLUS-IM, SBE9-10PLUS-SIM, SBE9-10S, SBE9-15IM, SBE9-15IM-AD, SBE9-15IM-AD-S, SBE9-15IMS, SBE9-15M, SBE9-15MS, SBE9-15PLUS-IM, SBE9-15PLUS-SIM, SBG9-10IM, SBG9-10IM-AD, SBG9-10IM-AD-S, SBG9-10IMS, SBG9-10M, SBG9-10MS, SBG9-10PLUS-IM, SBG9-10PLUS-SIM, SBG9-15IM, SBG9-15IM-AD, SBG9-15IM-AD-S, SBG9-15IMS, SBG9-15PLUS-IM, SBG9-15PLUS-SIM |                 |                     |



|                    |   |                 |                     |
|--------------------|---|-----------------|---------------------|
| <b>GEV No.</b>     | 345626  | <b>Ref. No.</b> | 12009956<br>X022106 |
| <b>description</b> | push button ø 23mm black arrow  |                 |                     |
| <b>For models:</b> | SBE9-10, SBE9-10I, SBE9-10IM, SBE9-10IM-AD, SBE9-10IM-AD-S, SBE9-10IMS, SBE9-10IS, SBE9-10M, SBE9-10MS, SBE9-10PLUS-IM, SBE9-10PLUS-SIM, SBE9-10S, SBE9-15IM, SBE9-15IM-AD, SBE9-15IM-AD-S, SBE9-15IMS, SBE9-15M, SBE9-15MS, SBE9-15PLUS-IM, SBE9-15PLUS-SIM, SBG9-10IM, SBG9-10IM-AD, SBG9-10IM-AD-S, SBG9-10IMS, SBG9-10M, SBG9-10MS, SBG9-10PLUS-IM, SBG9-10PLUS-SIM, SBG9-15IM, SBG9-15IM-AD, SBG9-15IM-AD-S, SBG9-15IMS, SBG9-15PLUS-IM, SBG9-15PLUS-SIM |                 |                     |

cam switches

on/off

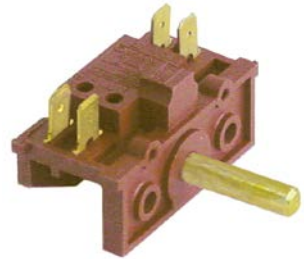

|                    |   |                 |                     |
|--------------------|---|-----------------|---------------------|
| <b>GEV No.</b>     | 345686  | <b>Ref. No.</b> | 12020265<br>R753000 |
| <b>description</b> | cam switch 2 operating positions 2NO sequence 0-1 10A shaft ø 6x4.6mm shaft L 23mm connection male faston 6.3mm ON-OFF plastic  |                 |                     |
| <b>For models:</b> | HEI-10-11, HEI-20-11, HME-20-11, HMI-10-11, HMI-10-11UL, HMI-10-21, HMI-10-21UL, HMI-2-10-11, HMM-10-11, HMM-10-11UL, HMM-10-21, HMM-10-21UL, HMM-20-11, HMM-20-11UL, HMM-20-21, HMM-20-21UL, HMM-2-10-11, HMM-6-11, HMP-20-11, MFHMM-20-11 |                 |                     |

7-position



|                    |   |                 |                     |
|--------------------|---|-----------------|---------------------|
| <b>GEV No.</b>     | 300031  | <b>Ref. No.</b> | 12024405<br>U673007 |
| <b>description</b> | cam switch 7 operating positions 1NO/2CO sequence 0-1-2-3-4-5-6 16A shaft ø 6x4.6mm shaft L 23mm connection male faston 6.3mm 7-position plastic                    |                 |                     |
| <b>For models:</b> | CE6-20, CE6-40, CE6-41, CE7-20, CE7-20Q, CE7-40, CE7-40Q, CE7-41, CE7-41Q, CE9-20, CE9-20AD, CE9-20PLUS, CE9-40, CE9-40AD, CE9-40PLUS, CE9-41, CE9-41AD, CE9-41PLUS |                 |                     |



Зип Общепит

vsezip.ru

+7(812)987-08-81

2 operating positions



|                    |  |                 |                     |
|--------------------|--|-----------------|---------------------|
| <b>GEV No.</b>     | 301316   | <b>Ref. No.</b> | 12024465<br>T343008 |
| <b>description</b> | cam switch 2 operating positions 2NO sequence 0-1 16A shaft ø 6x4.6mm shaft L 23mm connection male faston 6.3mm 660201   |                 |                     |
| <b>For models:</b> | BME7-05, BME7-10, BMG7-10, CPE9-05, CPE9-05NC, CPE9-05S, CPE9-05SNC, CPG9-05, CPG9-05NC, CPG9-05S, CPG9-05SNC, HGC-10-21, HGC-20-21, MV7-10BM, MV9-10BM, MV9-15BM, SBE7-10, SBE9-10, SBE9-10I, SBE9-10IM, SBE9-10IMS, SBE9-10IS, SBE9-10M, SBE9-10MS, SBE9-10S, SBE9-15IM, SBE9-15IMS, SBE9-15M, SBE9-15MS, SBG7-10, SBG9-10, SBG9-10I, SBG9-10IM, SBG9-10IMS, SBG9-10IS, SBG9-10M, SBG9-10MS, SBG9-10S, SBG9-15IM, SBG9-15IMS |                 |                     |



|                        |   |                 |                     |                     |
|------------------------|---|-----------------|---------------------|---------------------|
| <b>GEV No.</b>         | 345687  | <b>Ref. No.</b> | 12019852<br>T013001 |                     |
| <b>description</b>     | cam switch 3 operating positions sequence 1-0-2 16A shaft ø 6x4.6mm shaft L 23mm connection male faston 6.3mm plastic |                 |                     |                     |
| <b>For models:</b>     | HCG-10-11, HCG-10-21, HCG-20-11, HCG-20-21, HCG-2-10-11, HCG-2-20-11, HCG-6-11, HGC-10-11, HGC-20-11, HGC-6-11        |                 |                     |                     |
| <b>accessories for</b> | 345687  |                 |                     |                     |
|                        | <b>GEV No.</b>  | 691074          | <b>Ref. No.</b>     | 12024516<br>R663046 |
|                        | gasket switch shaft   |                 |                     |                     |

3 operating positions



|                    |   |                 |                     |
|--------------------|---|-----------------|---------------------|
| <b>GEV No.</b>     | 345684  | <b>Ref. No.</b> | 12019182<br>R663026 |
| <b>description</b> | cam switch 3 operating positions 10NO sequence 1-2-3 16A shaft ø 6x4.6mm shaft L 34mm connection male faston 6.3mm plastic  |                 |                     |
| <b>For models:</b> | HEI-10-21, HEI-20-21, HEM-10-11, HEM-10-21, HEM-20-11, HEM-20-21, HEM-6-11, HEP-10-11, HEP-20-11, HEP-6-11, HGC-10-21, HGC-20-21, HGV-10-21, HGV-20-21, HME-10-11, HME-10-21, HME-20-11, HME-20-21, HME-2-10-11, HME-2-20-11, HME-6-11, HMP-10-11, HMP-10-21, HMP-20-11, HMP-20-21, HMP-2-10-11, HMP-6-11 |                 |                     |

4 operating positions



|                    |   |                 |                     |
|--------------------|---|-----------------|---------------------|
| <b>GEV No.</b>     | 347386  | <b>Ref. No.</b> | 12024733<br>Z273005 |
| <b>description</b> | cam switch 4 operating positions 6NO sequence 0-1-2-3 16A shaft ø 6x4.6mm shaft L 23mm connection male faston 6.3mm 7LA 840601  |                 |                     |
| <b>For models:</b> | ECO-160, ECO-160D, ECO-160I, ECO-200, ECO-200D, ECO-200H, ECO-200HD, ECO-200HI, ECO-200I, ECO-2700D, ECO-2700I, ECO-280D, ECO-280I, ECO-370D, ECO-370I, ECO-4000D, ECO-4000I, ECO-460D, ECO-460I, ECO-550D, ECO-550I, ECO-6000D, ECO-6000I, FI-160, FI-160AR, FI-160D, FI-160I, FI-200, FI-200AR, FI-200D, FI-200H, FI-200HD, FI-200HI, FI-200I, FI-200W, FI-200WL, FI-200WR, FI-2700D, FI-2700I, FI-280D, FI-280I, FI-370D, FI-370I, FI-4000D, FI-4000I, FI-460D, FI-460I, FI-550D, FI-550I, FI-6000D... (Other models you can see in the webshop) |                 |                     |

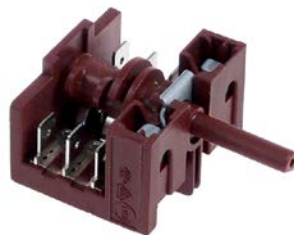

|                    |   |                 |                     |
|--------------------|---|-----------------|---------------------|
| <b>GEV No.</b>     | 345492  | <b>Ref. No.</b> | 12025105<br>Z213003 |
| <b>description</b> | cam switch 3 operating positions 3NO sequence 1-0-2 16A shaft ø 6x4.6mm shaft L 23mm connection male faston 6.3mm |                 |                     |



|                    |  |                 |                     |
|--------------------|--|-----------------|---------------------|
| <b>GEV No.</b>     | 347638   | <b>Ref. No.</b> | 12023800<br>R693004 |
| <b>description</b> | cam switch 4 operating positions 6NO sequence 0-1-2-3 16A shaft ø 6x4.6mm shaft L 23mm connection male faston 6.3mm plastic  |                 |                     |
| <b>For models:</b> | CPE9-05, CPE9-05AD, CPE9-05AD-S, CPE9-05NC, CPE9-05PLUS, CPE9-05PLUS-S, CPE9-05S, CPE9-05SNC, CPG9-05, CPG9-05AD, CPG9-05AD-S, CPG9-05NC, CPG9-05PLUS, CPG9-05PLUS-S, CPG9-05S, CPG9-05SNC, HEI-10-11, HEI-20-11, HEI-6-11, HMI-10-11, HMI-10-11UL, HMI-10-21, HMI-10-21UL, HMI-2-10-11, HMI-6-11, HMI-6-11UL, ME7-10BM, ME9-10BM, ME9-10BMS, ME9-10PLUS-BM, ME9-10PLUS-BMS, ME9-15BM, ME9-15BM316, ME9-15BM-AD, ME9-15BMS, ME9-15PLUS-BM, ME9-15PLUS-BMS, MG7-10, MG7-10BM, MG9-10, MG9-10AD, MG9-10BM, MG9-10BMAD, MG9-10BMS, MG9-10BMSAD, MG9-10PLUS, MG9-10PLUS-BM, MG9-10PLUS-BMS, MG9-10PLUS-S, MG9-10S... (Other models you can see in the webshop) |                 |                     |



Зип Общепит

vsezip.ru

+7(812)987-08-81



1

|                    |   |                 |                     |
|--------------------|---|-----------------|---------------------|
| <b>GEV No.</b>     | 345409  | <b>Ref. No.</b> | 12023918<br>U673006 |
| <b>description</b> | cam switch 4 operating positions 8NO sequence 0-1-2-3 16A shaft $\varnothing$ 6x4.6mm shaft L 23mm connection male faston 6.3mm plastic               |                 |                     |
| <b>For models:</b> | CE6-41, CE7-41, CE7-41Q, CE9-41, CE9-41AD, CE9-41PLUS, CGE6-41, CGE7-229, CGE7-41, CGE7-41H, CGE9-11, CGE9-41, CGE9-41AD, CGE9-41PLUS, HE9-10, HE9-20 |                 |                     |



1

|                    |  |                 |         |
|--------------------|--|-----------------|---------|
| <b>GEV No.</b>     | 345493   | <b>Ref. No.</b> | Z223001 |
| <b>description</b> | cam switch 4 operating positions sequence 1-0-2-3 shaft $\varnothing$ 6x4.6mm connection male faston 8-pole  |                 |         |
| <b>For models:</b> | FI-30, FI-30AR, FI-30AR+DD, FI-30B, FI-30B-BT-UK, FI-30-UK, FI-48, FI-48AR, FI-48B, FI-48B-BT-UK, FI-48C, FI-48D, FI-48HY-CLINIC, FI-48W, FI-64, FI-64AR, FI-64B, FI-64B-BT-UK, FI-64C, FI-64D, FI-64HY-CLINIC, FI-64W, MF-48, MF-64 |                 |         |

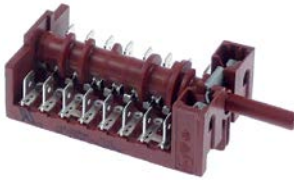

1

|                    |  |                 |          |
|--------------------|--|-----------------|----------|
| <b>GEV No.</b>     | 347817   | <b>Ref. No.</b> | 12024445 |
| <b>description</b> | cam switch 4 operating positions 8NO sequence 1-0-2-3 16A shaft $\varnothing$ 6x4.6mm shaft L 23mm connection male faston 6.3mm plastic              |                 |          |
| <b>For models:</b> | CO-500, CO-500B, CO-500BDD, CO-500DD, CO-501, CO-501B, CO-501BDD, CO-501DD, CO-501-SOFT, EASY-500, EASY-500B, EASY-500DD, EASY-500HP, EASY-500HPWBDD |                 |          |

### 6 operating positions



1

|                    |   |                 |                     |
|--------------------|---|-----------------|---------------------|
| <b>GEV No.</b>     | 345683  | <b>Ref. No.</b> | 12019003<br>R663025 |
| <b>description</b> | cam switch 6 operating positions 7NO sequence 0-1-2-3-4-5 16A shaft $\varnothing$ 6x4.6mm shaft L 23mm connection male faston 6.3mm plastic   |                 |                     |
| <b>For models:</b> | HEM-10-11, HEM-20-11, HEM-6-11, HEP-10-11, HEP-20-11, HEP-6-11, HME-10-11, HME-10-21, HME-20-11, HME-20-21, HME-2-10-11, HME-2-20-11, HME-6-11, HMP-10-11, HMP-10-21, HMP-20-11, HMP-20-21, HMP-2-10-11, HMP-6-11 |                 |                     |



1

|                    |   |                 |                                 |
|--------------------|---|-----------------|---------------------------------|
| <b>GEV No.</b>     | 345494  | <b>Ref. No.</b> | 12024972 old version<br>Z433001 |
| <b>description</b> | cam switch 4 operating positions sequence 1-0-2-3 momentary 16A(4)A shaft $\varnothing$ 6x4.6mm shaft L 23mm connection male faston 6.3mm plastic |                 |                                 |
| <b>For models:</b> | LVC-15D, LVC-21B, LVC-21C, LVC-21D, LVC-21W, LVR-14D, LVR-20, LVR-20B, LVR-20D, MF-21   |                 |                                 |



1

|                    |   |                 |                     |
|--------------------|---|-----------------|---------------------|
| <b>GEV No.</b>     | 347578  | <b>Ref. No.</b> | 12024290<br>Z683085 |
| <b>description</b> | cam switch 6 operating positions 7NO sequence 0-1-2-3-4-5 16A shaft $\varnothing$ 6x4.6mm shaft L 23mm connection male faston 6.3mm plastic |                 |                     |
| <b>For models:</b> | ECO-120, ECO-120B, FI-100, FI-100AR, FI-100B, FI-120, FI-1200, FI-120AR+DD, FI-120B, FI-120W, FI-900, LABP-1000, LABP-1200, MF-120          |                 |                     |

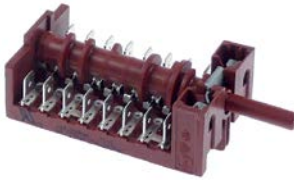

1

|                    |   |                 |                      |
|--------------------|---|-----------------|----------------------|
| <b>GEV No.</b>     | 348225  | <b>Ref. No.</b> | 12024972 new version |
| <b>description</b> | cam switch 4 operating positions sequence 1-0-2-3 momentary 16A(4)A shaft $\varnothing$ 6x4.6mm shaft L 23mm connection male faston 6.3mm plastic |                 |                      |



1

|                    |   |                 |                     |
|--------------------|---|-----------------|---------------------|
| <b>GEV No.</b>     | 345688  | <b>Ref. No.</b> | 12019026<br>R723011 |
| <b>description</b> | cam switch 6 operating positions sequence 0-1-2-3-4-5 16A shaft $\varnothing$ 6x4.6mm shaft L 23mm connection male faston 6.3mm plastic |                 |                     |
| <b>For models:</b> | HMG-10-11, HMG-10-11UL, HMG-10-21, HMG-10-21UL, HMG-20-11, HMG-2-10-11, HMG-6-11  |                 |                     |





Зип Общежит rotary switches

vsezip.ru

+7(812)987-08-81



1

|                    |  |                 |                     |
|--------------------|--|-----------------|---------------------|
| <b>GEV No.</b>     | 347091   | <b>Ref. No.</b> | 12018564<br>T113030 |
| <b>description</b> | cam switch 6 operating positions sequence 0-1-2-3-4-5 16A shaft $\varnothing$ 6x4.6mm shaft L 23mm connection male faston 6.3mm plastic        |                 |                     |
| <b>For models:</b> | HGV-10-11, HGV-20-11, HVG-10-11, HVG-10-11UL, HVG-10-21, HVG-10-21UL, HVG-20-11, HVG-20-21, HVG-2-10-11, HVG-2-20-21, MFHVG-10-11, MFHVG-10-21 |                 |                     |



1

|                    |  |                 |                     |
|--------------------|--|-----------------|---------------------|
| <b>GEV No.</b>     | 347874   | <b>Ref. No.</b> | 12023965<br>Z743019 |
| <b>description</b> | rotary switch 5 0-1-2-3-4 sets of contacts 10 type 46RCTH 400V 16A shaft $\varnothing$ 6x4.6mm shaft L 23mm shaft 6x4.6 connection male faston 6.3mm |                 |                     |
| <b>For models:</b> | FI-80BBT-UK  |                 |                     |

7 operating positions

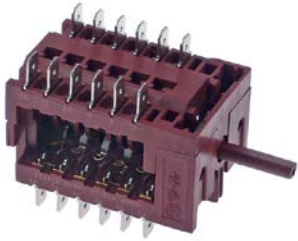

1

|                    |   |                 |                     |
|--------------------|---|-----------------|---------------------|
| <b>GEV No.</b>     | 301298  | <b>Ref. No.</b> | 12024932<br>Z713097 |
| <b>description</b> | cam switch 7 operating positions 12NO sequence 0-1-2-3-4-5-6 16A shaft $\varnothing$ 6x4.6mm shaft L 23mm connection male faston 6.3mm plastic 12-pole  |                 |                     |
| <b>For models:</b> | CO-110, CO-110B, CO-110BDD, CO-110DD, CO-170, CO-170B, CO-170BDD, CO-170DD, CO-170HRS, CO-170HRSDD, CO-170HRS-SOFT, CO-170-SOFT, ECO-120B, FI-100B, FI-100BBT-UK, FI-120B, FI-120C, FI-120HY-CLINIC |                 |                     |

magnetic switches

32x15mm



1

|                    |                 |                 |                       |
|--------------------|-----------------|-----------------|-----------------------|
| <b>GEV No.</b>     | 346510          | <b>Ref. No.</b> | 12032901<br>RT4000335 |
| <b>description</b> | magnetic switch |                 |                       |

operation switches

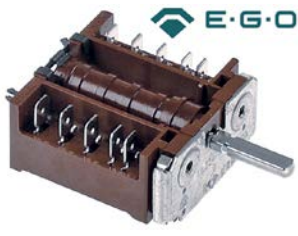

1

|                    |  |                 |                     |
|--------------------|--|-----------------|---------------------|
| <b>GEV No.</b>     | 301109   | <b>Ref. No.</b> | 12024459<br>X163007 |
| <b>description</b> | cam switch 2 operating positions 4NO 16A sequence 0-1 shaft $\varnothing$ 6x4.6mm shaft L 23mm connection male faston 6.3mm plastic 4-pole   |                 |                     |
| <b>For models:</b> | BME6-05, BME7-05, BME7-10, BME9-05, BME9-05AD, BME9-05PLUS, BME9-05V-T, BME9-10, BME9-10AD, BME9-10PLUS, BME9-10V-T, CMF6-05, CPE6-05, FE6-05, FE6-05TE, FE6-10, FE6-10TE, FE7-05-1C, FE7-05-2C, FE-710, FE7-10-2C, FE7-10-4C, FE-720, FE9-05, FE9-05-1C, FE9-05-2C, FE9-05AD, FE9-05PLUS, FE9-05PLUS-S, FE9-05S, FE9-05S-1C, FE9-05S-2C, FE9-05S-AD, FE9-05USMC, FE9-10, FE9-10-2C, FE9-10-4C, FE9-10AD, FE9-10PLUS, FE-920, FG7-05-1C, FG7-05-2C, FG-710, FG7-10-2C, FG7-104C, FG7-10-4C, FG-720, FG9-05, FG9-05-1C, FG9-05-2C...(Other models you can see in the webshop) |                 |                     |

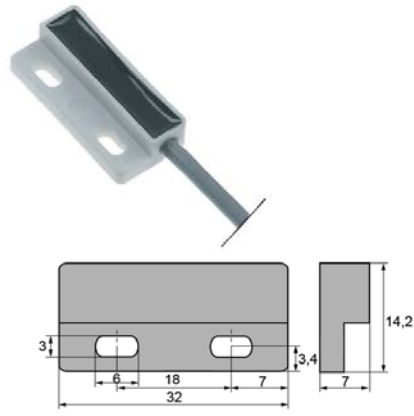

1

|                    |   |                 |                        |
|--------------------|---|-----------------|------------------------|
| <b>GEV No.</b>     | 345109  | <b>Ref. No.</b> | 12034091<br>RT30161415 |
| <b>description</b> | magnetic switch L 32mm W 15mm 1NO 250V 1A P max. 40W connection cable cable length 2000mm |                 |                        |

electric components



Зип.Общепит

Ø 6mm

65x20mm

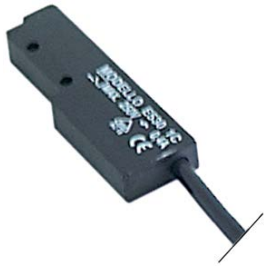

1

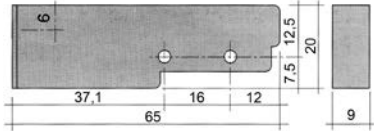

|  |  |                 |                     |
|--|--|-----------------|---------------------|
| <b>GEV No.</b>   | 345116   | <b>Ref. No.</b> | 12024560<br>Z100522 |
| <b>description</b>   | magnetic switch L 65mm W 20mm 1NO 250V 0.4A P max. 100W connection cable cable length 3000mm   |                 |                     |
| <b>For models:</b>   | ACE-061, ACE-101, ACE-102, ACE-201, ACE-202, ACG-061, ACG-101, ACG-102, ACG-201, ACG-202, AE-061, AE-061W, AE-101, AE-101W, AE-102, AE-102W, AE-201, AE-202, AG-061, AG-061W, AG-101, AG-101W, AG-102, AG-102W, AG-201, AG-202, APE-061, APE-061W, APE-101, APE-101W, APE-102, APE-102W, APE-201, APE-202, APG-061, APG-061W, APG-101, APG-101W, APG-102, APG-102W, APG-201, APG-202, COE-061, COE-101, COE-102, COE-201, COE-202, COG-061, COG-101, COG-102...(Other models you can see in the webshop) |                 |                     |
| <b>accessories for</b>   | 345116   |                 |                     |
|  | <b>GEV No.</b>   | 345399          | <b>Ref. No.</b> —   |
| magnet Ø 3.3mm L 40mm H 8mm W 13mm hole distance 30mm M3                           |  |                 |                     |

84x30mm



1

|                    |                               |                 |                     |
|--------------------|-------------------------------|-----------------|---------------------|
| <b>GEV No.</b>     | 347089                        | <b>Ref. No.</b> | 12039784<br>Z100511 |
| <b>description</b> | magnetic switch L 84mm W 30mm |                 |                     |

vsezip.ru

+7(812)987-08-81

1

|                    |   |                 |                     |
|--------------------|---|-----------------|---------------------|
| <b>GEV No.</b>     | 345202  | <b>Ref. No.</b> | 12024477<br>Z203009 |
| <b>description</b> | magnetic switch 250V 0.04A P max. 10W probe L 29mm 1NO connection plug cable length 1400mm  |                 |                     |
| <b>For models:</b> | AD-120, AD-120B, AD-120BBTDD-UK, AD-120C, AD-120CW, AD-120HY, AD-125, AD-125HRS, AD-125-SOFT, AD-15, AD-15D, AD-20C-UK, AD-21, AD-21B, AD-21BDD, AD-21C, AD-21D, AD-21DD, AD-21W, AD-45BBT, AD-48, AD-48B, AD-48BDD, AD-48C, AD-48D, AD-48DD, AD-48HY, AD-48W, AD-505, AD-505-SOFT, AD-64, AD-64B, AD-64BBT, AD-64BDD, AD-64BTDD, AD-64C, AD-64CW, AD-64D, AD-64DD, AD-64HY, AD-72, AD-72W, AD-90, AD-90BA, AD-90BBT, AD-90BDD, AD-90DD, ADE-120, ADE-120B, ATA-061...(Other models you can see in the webshop) |                 |                     |

Ø 8mm



1

|                    |  |                 |                        |
|--------------------|--|-----------------|------------------------|
| <b>GEV No.</b>     | 346511   | <b>Ref. No.</b> | 12031820<br>RT30161417 |
| <b>description</b> | magnetic switch 230V 0.2A P max. 50W probe L 60mm 1NO connection cable cable length 2500mm |                 |                        |

accessories

magnets



1

|                    |                              |                 |                        |
|--------------------|------------------------------|-----------------|------------------------|
| <b>GEV No.</b>     | 346514                       | <b>Ref. No.</b> | 12033601<br>RT30161409 |
| <b>description</b> | magnet Ø 10mm L 40mm Hmm Wmm |                 |                        |





Зип Общепит  
control equipment

vsezip.ru

+7(812)987-08-81

|  |  |                 |                     |
|--|--|-----------------|---------------------|
|  <p>1</p> |  |                 |                     |
| <b>GEV No.</b>   | 347093   | <b>Ref. No.</b> | 12024499<br>Z271207 |
| <b>description</b>   | magnet ø 31mm Lmm H 15mm Wmm M5  |                 |                     |
| <b>For models:</b>   | ECO-160, ECO-160D, ECO-160I, ECO-200, ECO-200D, ECO-200H, ECO-200HD, ECO-200HI, ECO-200I, ECO-280D, ECO-280I, ECO-370D, ECO-370I, ECO-460D, ECO-460I, ECO-550D, ECO-550I, FI-160, FI-160AR, FI-160D, FI-160I, FI-200, FI-200AR, FI-200D, FI-200H, FI-200HD, FI-200HI, FI-200I, FI-200W, FI-200WL, FI-200WR, FI-280D, FI-280I, FI-370D, FI-370I, FI-460D, FI-460I, FI-550D, FI-550I |                 |                     |

|  |   |                 |                     |
|--|---|-----------------|---------------------|
|  <p>1</p> |   |                 |                     |
| <b>GEV No.</b>   | 505004  | <b>Ref. No.</b> | 12024303<br>Z200506 |
| <b>description</b>   | magnet ømm L 17mm H 12mm W 14mm   |                 |                     |
| <b>For models:</b>   | ACE-061, ACE-101, ACE-102, ACG-061, ACG-101, ACG-102, AD-120, AD-120B, AD-120BBTDD-UK, AD-120C, AD-120CW, AD-120HY, AD-15, AD-15D, AD-20C-UK, AD-21, AD-21B, AD-21BDD, AD-21C, AD-21D, AD-21DD, AD-21W, AD-45BBT, AD-48, AD-48B, AD-48BDD, AD-48C, AD-48D, AD-48DD, AD-48HY, AD-48W, AD-64, AD-64B, AD-64BBT, AD-64BDD, AD-64BTDD, AD-64C, AD-64CW, AD-64D, AD-64DD, AD-64HY, AD-72, AD-72W, AD-90, AD-90BA, AD-90BBT, AD-90BDD, AD-90DD, ADE-120, ADE-120B...(Other models you can see in the webshop) |                 |                     |

|  |   |                 |                     |
|--|---|-----------------|---------------------|
| <p>magnetic holders</p>  <p>1</p> |   |                 |                     |
| <b>GEV No.</b>   | 700816  | <b>Ref. No.</b> | 12024094<br>Z200507 |
| <b>description</b>   | protection cap for magnet internal size 14x17mm H 17mm for dishwasher   |                 |                     |
| <b>For models:</b>   | AD-120, AD-120B, AD-120BBTDD-UK, AD-120C, AD-120CW, AD-120HY, AD-15, AD-15D, AD-20C-UK, AD-21, AD-21B, AD-21BDD, AD-21C, AD-21D, AD-21DD, AD-21W, AD-45BBT, AD-48, AD-48B, AD-48BDD, AD-48C, AD-48D, AD-48DD, AD-48HY, AD-48W, AD-64, AD-64B, AD-64BBT, AD-64BDD, AD-64BTDD, AD-64C, AD-64CW, AD-64D, AD-64DD, AD-64HY, AD-72, AD-72W, AD-90, AD-90BA, AD-90BBT, AD-90BDD, AD-90DD, ADE-120, ADE-120B, COE-061, COE-101, COE-102, COG-061, COG-101, COG-102...(Other models you can see in the webshop) |                 |                     |

|   |   |                 |                     |
|---|---|-----------------|---------------------|
| <p>TELEMECANIQUE (EFA)</p> <p>XB2 series</p> <p>rotary switches</p>  <p>1</p> |   |                 |                     |
| <b>GEV No.</b>  | 345222  | <b>Ref. No.</b> | 12024490<br>Z103044 |
| <b>description</b>  | rotary selector mounting measurements ø22mm black latching sequence 0-1 |                 |                     |
| <b>For models:</b>  | ECO-1600, ECO-2300, ECO-3000, FI-1600, FI-2300, FI-3000                 |                 |                     |

|  |   |                 |                     |
|--|---|-----------------|---------------------|
| <p>lamps</p>  <p>1</p> |   |                 |                     |
| <b>GEV No.</b>   | 359807  | <b>Ref. No.</b> | 12039863<br>Z103056 |
| <b>description</b>   | light bulb socket Ba9s 24V 2W ø 10mm L 28mm clear       |                 |                     |
| <b>For models:</b>   | ECO-1600, ECO-2300, ECO-3000, FI-1600, FI-2300, FI-3000 |                 |                     |

|   |         |                 |                       |
|---|---------|-----------------|-----------------------|
| <p>encoders and potentiometers</p>  <p>1</p> |         |                 |                       |
| <b>GEV No.</b>  | 300198  | <b>Ref. No.</b> | 12030862<br>RT4000404 |
| <b>description</b>  | encoder |                 |                       |

|  |   |                 |                     |
|--|---|-----------------|---------------------|
|  <p>1</p> |   |                 |                     |
| <b>GEV No.</b>   | 300253  | <b>Ref. No.</b> | 12024753<br>T513009 |
| <b>description</b>   | encoder shaft L 16mm for combi-steamer cable length 125mm shaft 6x4.6mm |                 |                     |
| <b>For models:</b>   | VE-061, VE-101, VE-102, VE-201, VE-202, VG-101, VG-102, VG-201, VG-202  |                 |                     |

1 electric components

Зип.Общепит

lamps  
indicator lights  
vsezip.ru  
indicator lights 3-piece (housing, lens and bulb)

+7(812)987-08-81

lamps  
light bulbs

|   |  |                 |                     |
|---|--|-----------------|---------------------|
|  |  |                 |                     |
| 1   |  |                 |                     |
| <b>GEV No.</b>  | 300254   | <b>Ref. No.</b> | 12018545<br>T303022 |
| <b>description</b>  | encoder shaft L 16mm for combi-steamer cable length 160mm shaft 6x4.6mm  |                 |                     |
| <b>For models:</b>  | HEI-10-21, HEI-20-21, HEM-10-21, HEM-20-21, HEP-10-21, HEP-20-21, HGC-10-21, HGC-20-21, HGP-10-21, HGP-20-21, HGV-10-21, HGV-20-21 |                 |                     |

|   |  |                 |                     |
|---|--|-----------------|---------------------|
|  |  |                 |                     |
| 1   |  |                 |                     |
| <b>GEV No.</b>  | 401717   | <b>Ref. No.</b> | 12020078<br>T303020 |
| <b>description</b>  | potentiometer  |                 |                     |
| <b>For models:</b>  | HEI-10-21, HEI-20-21, HEM-10-21, HEM-20-21, HGV-10-21, HGV-20-21 |                 |                     |

|  |  |                 |                       |
|--|--|-----------------|-----------------------|
|  |  |                 |                       |
| 1  |  |                 |                       |
| <b>GEV No.</b>   | 300197   | <b>Ref. No.</b> | 12032034<br>RT4000464 |
| <b>description</b>   | potentiometer 4.7KOhm rotation 360° shaft ø 5.9mm with switch shaft L 22mm |                 |                       |

|   |  |                 |          |
|---|--|-----------------|----------|
|  |  |                 |          |
| 1   |  |                 |          |
| <b>GEV No.</b>  | 403747   | <b>Ref. No.</b> | 12043405 |
| <b>description</b>  | potentiometer rotation 360° shaft ø 6x4.6mm shaft L 13mm   |                 |          |
| <b>For models:</b>  | ACE-061, ACE-101, AE-061, AE-061W, AE-101, AE-101W, AE-102, AE-102W, AE-201, AE-202, AG-061, AG-061W, AG-101, AG-101W, AG-102, AG-102W, AG-201, AG-202, APE-061, APE-101 |                 |          |

|   |  |                 |                        |
|---|--|-----------------|------------------------|
|  |  |                 |                        |
| 1   |  |                 |                        |
| <b>GEV No.</b>  | 400106   | <b>Ref. No.</b> | 12027410<br>RT88171303 |
| <b>description</b>  | pulsar KOhm rotation 360° shaft ø 6mm type CPC |                 |                        |

|  |   |                 |                     |
|--|---|-----------------|---------------------|
|  |   |                 |                     |
| 1  |   |                 |                     |
| <b>GEV No.</b>   | 359807  | <b>Ref. No.</b> | 12039863<br>Z103056 |
| <b>description</b>   | light bulb socket Ba9s 24V 2W ø 10mm L 28mm clear       |                 |                     |
| <b>For models:</b>   | ECO-1600, ECO-2300, ECO-3000, FI-1600, FI-2300, FI-3000 |                 |                     |

|   |   |                 |                        |
|---|---|-----------------|------------------------|
| <b>indicator lights (complete)</b>  |   |                 |                        |
| 32x14mm   |   |                 |                        |
|  |   |                 |                        |
| 1   |   |                 |                        |
| <b>GEV No.</b>  | 348218  | <b>Ref. No.</b> | 12037303<br>6021130010 |
| <b>description</b>  | indicator light mounting measurements 32x14mm 230V connection male faston 6.3mm temp.-resist. 105°C   |                 |                        |
| <b>For models:</b>  | AEP-1402, AEP-1602, AEP-2103, AEP-701, AEP-801, AEP-802, AF-1402-MIX, AF-1403-C, AF-1403-P, AF-1404-C, AF-1404-P, AF-1602-MIX, AF-1603-C, AF-1603-P, AF-1604-C, AF-1604-P, AF-2104-C, AF-2104-P, AF-2105-C, AF-2105-P, AF-2106-C, AF-2106-P, AF-702-C, AF-702-P, AF-802-C, AF-802-P, AFN-1402, AFN-1403, AFN-1404, AFN-1602, AFN-1603, AFN-1604, AFN-702, AFN-801, AFN-802, AFP-1402, AFP-1403, AFP-1404, AFP-1404-USMC, AFP-1602, AFP-1602-2, AFP-1603, AFP-1603-2, AFP-1604, AFP-2103, AFP-2104, AFP-2105, AFP-2106, AFP-701, AFP-702...(Other models you can see in the webshop) |                 |                        |

|   |  |                 |          |
|---|--|-----------------|----------|
| <b>ø 9mm</b>  |  |                 |          |
|  |  |                 |          |
| 1   |  |                 |          |
| <b>GEV No.</b>  | 359137   | <b>Ref. No.</b> | 12024344 |
| <b>description</b>  | indicator light ø 9mm 230V yellow connection male faston 6.3mm temp.-resist. 120°C with lens   |                 |          |
| <b>For models:</b>  | ECO-120, ECO-120B, FI-100, FI-100AR, FI-100B, FI-100BBT-UK, FI-120, FI-120AR+DD, FI-120B, FI-120C, FI-120HY-CLINIC, FI-120W, FI-80, FI-80AR, FI-80BBT-UK, FI-80W, GA-20, GA-20D, GA-40, GA-40D |                 |          |

|   |   |                 |                      |
|---|---|-----------------|----------------------|
| <b>ø12mm</b>  |   |                 |                      |
| with screw socket   |   |                 |                      |
|  |   |                 |                      |
| 1   |   |                 |                      |
| <b>GEV No.</b>  | 359048  | <b>Ref. No.</b> | 12035239<br>ICR13205 |
| <b>description</b>  | indicator light ø 12mm 230V yellow connection male faston 6.3mm |                 |                      |



Зип Общепит

vsezip.ru

(812)987-08-81

|   |  |                 |   |
|---|--|-----------------|---|
| 1  |  |                 |   |
| <b>GEV No.</b>  | 359027   | <b>Ref. No.</b> | 12025211<br>12036324<br>DO1DL14713<br>R693055 |
| <b>description</b>  | indicator light ø 12mm 250V green connection male faston 6.3mm   |                 |   |
| <b>For models:</b>  | BME6-05, BME7-05, BME7-10, BME9-05, BME9-05AD, BME9-05PLUS, BME9-05V-T, BME9-10, BME9-10AD, BME9-10PLUS, BME9-10V-T, CE6-41, CE7-41, CE7-41Q, CE9-41, CGE6-41, CGE7-41, CGE7-41H, CGE9-11, CGE9-41, CGE9-41AD, CGE9-41PLUS, CMF6-05, CPE6-05, CPE7-05, CPE7-05NC, CPE9-05, CPE9-05AD, CPE9-05AD-S, CPE9-05NC, CPE9-05PLUS, CPE9-05PLUS-S, CPE9-05S, CPE9-05SNC, EASY-500, EASY-500B, EASY-500DD, EASY-500HP, EASY-500HPWBDD, EPC-350, FE-18, FE-25, FE-4, FE-6, FE6-05, FE6-05TE, FE6-10, FE6-10TE, FE7-05-1C, FE7-05-2C...(Other models you can see in the webshop) |                 |   |

|   |  |                 |                     |
|---|--|-----------------|---------------------|
| 1  |  |                 |                     |
| <b>GEV No.</b>  | 359193   | <b>Ref. No.</b> | 12023599<br>X143017 |
| <b>description</b>  | indicator light ø 12mm 250V green connection male faston 6.3mm temp.-resist. 120°C   |                 |                     |
| <b>For models:</b>  | CE9-41AD, CE9-41PLUS, ME7-10BM, SBE7-10, SBE9-10, SBE9-10I, SBE9-10I-AD, SBE9-10I-AD-S, SBE9-10IM, SBE9-10IM-AD, SBE9-10IM-AD-S, SBE9-10IMS, SBE9-10IS, SBE9-10M, SBE9-10MS, SBE9-10PLUS-I, SBE9-10PLUS-IM, SBE9-10S, SBE9-10USMC, SBE9-15IM, SBE9-15IM-AD, SBE9-15IM-AD-S, SBE9-15IMS, SBE9-15M, SBE9-15MS, SBE9-15PLUS-IM, SBG7-10, SBG9-10, SBG9-10I, SBG9-10I-AD, SBG9-10I-AD-S, SBG9-10IM, SBG9-10IM-AD, SBG9-10IM-AD-S, SBG9-10IMS, SBG9-10IS, SBG9-10M, SBG9-10MS, SBG9-10PLUS-I, SBG9-10PLUS-IM, SBG9-10PLUS-SI, SBG9-10PLUS-SIM, SBG9-10S, SBG9-15IM, SBG9-15IM-AD, SBG9-15IM-AD-S, SBG9-15IMS, SBG9-15PLUS-IM, SBG9-15PLUS-SIM |                 |                     |

with plug-in socket

|   |   |                 |                     |
|---|---|-----------------|---------------------|
| 1  |   |                 |                     |
| <b>GEV No.</b>  | 359898  | <b>Ref. No.</b> | 12021166<br>Z203004 |
| <b>description</b>  | indicator light ø 12mm 230V green connection male faston 6.3mm  |                 |                     |
| <b>For models:</b>  | BME7-05, BME7-10, BME9-05, BME9-10, CE7-41, CE9-41, CGE7-203, CGE7-41, CGE9-41, FE-18, FE-25, FE-4, FE-6, FE-710, FE-8, FE9-05, FE9-05S, FE9-10, FE-920, FG-710, FG-720, FG9-05, FG9-05S, FG9-10, FG-920, FG-940, FI-30, FI-48, FI-48B, FI-48W, FI-64, FI-64B, FI-64W, FTE7-05, FTE7-10, FTE9-05L, FTE9-05R, FTE9-10L, FTE9-10L+R, FTE9-10R, FTEC9-05, FTEC9-05L, FTEC9-05R, FTEC9-10, FTEC9-10L, FTEC9-10L+R, FTEC9-10R, GA-20, GA-40, HCG-10-11...(Other models you can see in the webshop) |                 |                     |

ø13mm  
with plug-in socket

|   |  |                 |         |
|---|--|-----------------|---------|
| 1  |  |                 |         |
| <b>GEV No.</b>  | 359142   | <b>Ref. No.</b> | Z203004 |
| <b>description</b>  | indicator light ø 13mm green 230V connection male faston 6.3mm temp.-resist. 120°C Qty 1 pcs |                 |         |

|   |  |                 |  |
|---|--|-----------------|--|
| 1  |  |                 |  |
| <b>GEV No.</b>  | 505099   | <b>Ref. No.</b> | 12016901<br>12024254<br>12036445<br>K008B41002<br>R214902<br>R693056<br>X353021<br>Z203005 |
| <b>description</b>  | indicator light ø 12mm 230V yellow   |                 |  |
| <b>For models:</b>  | BME6-05, BME7-05, BME7-10, BME9-05, BME9-05AD, BME9-05PLUS, BME9-05V-T, BME9-10, BME9-10AD, BME9-10PLUS, BME9-10V-T, CE6-20, CE6-40, CE6-41, CE7-20, CE7-20Q, CE7-40, CE7-40Q, CE7-41, CE7-41Q, CE9-20, CE9-20AD, CE9-20PLUS, CE9-40, CE9-40AD, CE9-40PLUS, CE9-41, CE9-41AD, CE9-41PLUS, CGE6-41, CGE7-41, CGE7-41H, CGE9-11, CGE9-41, CGE9-41AD, CGE9-41PLUS, CMF6-05, CPE6-05, CPE7-05, CPE7-05NC, CPE9-05, CPE9-05AD, CPE9-05AD-S, CPE9-05NC, CPE9-05PLUS, CPE9-05PLUS-S, CPE9-05S, CPE9-05SNC, CV6-20, CV6-40...(Other models you can see in the webshop) |                 |  |

ø14mm  
with plug-in socket

|   |  |                 |  |
|---|--|-----------------|--|
| 1  |  |                 |  |
| <b>GEV No.</b>  | 359148   | <b>Ref. No.</b> | 12021153<br>12039891<br>R343123<br>U183044 |
| <b>description</b>  | indicator light ø 14mm green 230V connection male faston 6.3mm temp.-resist. 120°C voltage AC  |                 |  |
| <b>For models:</b>  | CE-410, FE-18, FE-25, FE-4, FE-6, FE-8, FE-91-20, HCV-10-11, HCV-10-21, HCV-2-10-21, HE-10-11, HE-10-21, HE-2-10-11, HE-6-11, HG-10-21, HG-2-10-11 |                 |  |

|   |  |                 |                     |
|---|--|-----------------|---------------------|
| 1  |  |                 |                     |
| <b>GEV No.</b>  | 359149   | <b>Ref. No.</b> | 12039886<br>R343125 |
| <b>description</b>  | indicator light ø 14mm yellow 230V connection male faston 6.3mm temp.-resist. 105°C  |                 |                     |
| <b>For models:</b>  | CE-410, FE-18, FE-25, FE-4, FE-6, FE-8, FE-91-20, HCV-10-11, HCV-10-21, HCV-2-10-21, HE-10-11, HE-10-21, HE-2-10-11, HE-6-11, HG-10-21, HG-2-10-11 |                 |                     |

electric components



## Зип.Общепит

linear lamps

vsezip.ru

+7(812)987-08-81

ø18mm



1

|                    |   |                 |                        |
|--------------------|---|-----------------|------------------------|
| <b>GEV No.</b>     | 358197  | <b>Ref. No.</b> | 12024669<br>Z313080000 |
| <b>description</b> | indicator light ø 18mm yellow 250V connection F6.3 temp.-resist. 120°C plastic/metal complete   |                 |                        |
| <b>For models:</b> | BME6-05, BME7-05, BME7-10, BME9-05, BME9-05PLUS, BME9-05V-T, BME9-10, BME9-10PLUS, BME9-10V-T, CE6-20, CE6-40, CE6-41, CE7-20, CE7-20Q, CE7-40, CE7-40Q, CE7-41, CE7-41Q, CE9-20, CE9-20PLUS, CE9-40, CE9-40PLUS, CE9-41, CE9-41PLUS, CGE6-41, CGE7-41, CGE7-41H, CGE9-11, CGE9-41, CGE9-41PLUS, CMF6-05, CPE6-05, CPE7-05, CPE7-05NC, CPE9-05, CPE9-05NC, CPE9-05PLUS, CPE9-05PLUS-S, CPE9-05S, CPE9-05SNC, CV6-20, CV6-40, CV9-20PLUS, CV9-40PLUS, FE-18, FE-25, FE-4, FE-6, FE6-05TE, FE6-10TE...(Other models you can see in the webshop) |                 |                        |

## screw-on/push-on fit

## light bulbs

## for indicator lights



1

|                    |   |                 |                     |
|--------------------|---|-----------------|---------------------|
| <b>GEV No.</b>     | 359807  | <b>Ref. No.</b> | 12039863<br>Z103056 |
| <b>description</b> | light bulb socket Ba9s 24V 2W ø 10mm L 28mm clear       |                 |                     |
| <b>For models:</b> | ECO-1600, ECO-2300, ECO-3000, FI-1600, FI-2300, FI-3000 |                 |                     |

## halogen lamp

## for socket G4 / G6.35 / G9



1

500°C

|                    |   |                 |   |
|--------------------|---|-----------------|---|
| <b>GEV No.</b>     | 359596  | <b>Ref. No.</b> | 12025123<br>12036215<br>R663013<br>RT30240201 |
| <b>description</b> | halogen lamp socket G4 12V 10W temp.-resist. 500°C  |                 |   |
| <b>For models:</b> | ACE-061, ACE-101, ACE-102, ACE-201, ACE-202, ACG-061, ACG-101, ACG-102, ACG-201, ACG-202, AE-061, AE-061W, AE-101, AE-101W, AE-102, AE-102W, AE-201, AE-202, AG-061, AG-061W, AG-101, AG-101W, AG-102, AG-102W, AG-201, AG-202, APE-061, APE-061W, APE-101, APE-101W, APE-102, APE-102W, APE-201, APE-202, APG-061, APG-061W, APG-101, APG-101W, APG-102, APG-102W, APG-201, APG-202, HCG-10-11, HCG-10-21, HCG-20-11, HCG-20-21, HCG-2-10-11, HCG-2-20-11, HCG-6-11, HEI-10-21...(Other models you can see in the webshop) |                 |   |

## sockets for linear lamps

R7s



1

|                    |   |                 |                        |
|--------------------|---|-----------------|------------------------|
| <b>GEV No.</b>     | 359663  | <b>Ref. No.</b> | 12035430<br>6021290015 |
| <b>description</b> | lamp socket socket R7s 250V ømm for length of lamp 117.6mm H 47mm connection cable 150mm mounting distance 65mm holder length 140.5mm Qty 1 pcs |                 |                        |

## fluorescent lamps

## fluorescent lamps

## G13



1

|                    |  |                 |  |
|--------------------|--|-----------------|--|
| <b>GEV No.</b>     | 359383   | <b>Ref. No.</b> | 12036923<br>12037057<br>6001509001<br>6021290001 |
| <b>description</b> | fluorescent lamp socket G13 L 438mm 15W 230V Qty 1 pcs light colour 640  |                 |  |
| <b>For models:</b> | AEP-1402, AEP-1403, AEP-1404, AEP-1602, AEP-1603, AEP-1604, AEP-2103, AEP-701, AEP-702, AEP-801, AEP-802, AF-1402-MIX, AF-1403-C, AF-1403-P, AF-1404-C, AF-1404-P, AF-1602-MIX, AF-1603-C, AF-1603-P, AF-1604-C, AF-1604-P, AF-2104-C, AF-2104-P, AF-2105-C, AF-2105-P, AF-2106-C, AF-2106-P, AF-702-C, AF-702-P, AF-802-C, AF-802-P, AFP-1402, AFP-1402-FORZ, AFP-1402-MIX, AFP-1403, AFP-1403-C, AFP-1403-FORZ, AFP-1403-P, AFP-1404, AFP-1404-C, AFP-1404-FORZ, AFP-1404-P, AFP-1404-USMC, AFP-1602, AFP-1602-2, AFP-1603, AFP-1603-2, AFP-1604, AFP-2103, AFP-2104...(Other models you can see in the webshop) |                 |  |



1

|                    |  |                 |  |
|--------------------|--|-----------------|--|
| <b>GEV No.</b>     | 359371   | <b>Ref. No.</b> | 12036885<br>12036938<br>6001509002<br>6021290002 |
| <b>description</b> | fluorescent lamp socket G13 L 590mm 18W 230V Qty 1 pcs |                 |  |
| <b>For models:</b> | VM-100-I, VM-100-M, VM-135-I, VM-135-M                 |                 |  |

complete with holder

|   |   |                 |                                    |
|---|---|-----------------|------------------------------------|
|  |   |                 |                                    |
| <b>GEV No.</b>  | 360610  | <b>Ref. No.</b> | 12033220<br>12053986<br>6021290052 |
| <b>description</b>  | fluorescent lamp L 343mm W 23mm 8W 220-240V plug type Euro-8 (C7) type T5/T4 for FAGOR  |                 |                                    |
| <b>For models:</b>  | AEP-1402, AEP-1602, AEP-2103, AEP-701, AEP-801, AEP-802, AF-1402-MIX, AF-1403-C, AF-1403-P, AF-1404-C, AF-1404-P, AF-1602-MIX, AF-1603-C, AF-1603-P, AF-1604-C, AF-1604-P, AF-2104-C, AF-2104-P, AF-2105-C, AF-2105-P, AF-2106-C, AF-2106-P, AF-702-C, AF-702-P, AF-802-C, AF-802-P, AFP-1402, AFP-1403, AFP-1404, AFP-1602, AFP-1602-2, AFP-1603, AFP-1603-2, AFP-1604, AFP-2103, AFP-2104, AFP-2105, AFP-2106, AFP-701, AFP-702, AFP-801, AFP-802, AFP-802-2, AFP-802-2C, AFP-802-3C, ERM-150 |                 |                                    |

|   |  |                 |  |
|---|--|-----------------|--|
|  |  |                 |  |
| <b>GEV No.</b>  | 550772   | <b>Ref. No.</b> | 12033470<br>12036835<br>6000202505<br>6007170105 |
| <b>description</b>  | cover for fluorescent lamps L 540mm  |                 |  |
| <b>For models:</b>  | AEP-1402, AEP-1403, AEP-1404, AEP-1602, AEP-1603, AEP-1604, AEP-2103, AEP-701, AEP-702, AEP-801, AEP-802, AF-1402-MIX, AF-1403-C, AF-1403-P, AF-1404-C, AF-1404-P, AF-1602-MIX, AF-1603-C, AF-1603-P, AF-1604-C, AF-1604-P, AF-2104-C, AF-2104-P, AF-2105-C, AF-2105-P, AF-2106-C, AF-2106-P, AF-702-C, AF-702-P, AF-802-C, AF-802-P, AFP-1402, AFP-1402-FORZ, AFP-1402-MIX, AFP-1403, AFP-1403-C, AFP-1403-FORZ, AFP-1403-P, AFP-1404, AFP-1404-C, AFP-1404-FORZ, AFP-1404-P, AFP-1404-USMC, AFP-1602, AFP-1602-2, AFP-1603, AFP-1603-2, AFP-1604, AFP-2103, AFP-2104...(Other models you can see in the webshop) |                 |  |

accessories

ballasts

|   |   |                 |                        |
|---|---|-----------------|------------------------|
|  |   |                 |                        |
| <b>GEV No.</b>  | 401504  | <b>Ref. No.</b> | 12035299<br>6001507022 |
| <b>description</b>  | electrical ballast 18W 230V Qty 1 pcs   |                 |                        |
| <b>For models:</b>  | AEP-701, AEP-702, AEP-801, AEP-802, AFP-1402-MIX, AFP-2103, AFP-2104, AFP-2104-C, AFP-2104-P, AFP-2105, AFP-2105-C, AFP-2105-P, AFP-2106, AFP-2106-C, AFP-2106-P, AFP-701, AFP-702, AFP-702-C, AFP-702-P, AFP-801, AFP-802, AFP-802-2, VC-14-I, VC-14-M, VM-100-I, VM-100-M, VTP-139-C, VTP-139-P |                 |                        |

|   |  |                 |  |
|---|--|-----------------|--|
|  |  |                 |  |
| <b>GEV No.</b>  | 401505   | <b>Ref. No.</b> | 12035296<br>12036849<br>6001507023<br>6021290014 |
| <b>description</b>  | electrical ballast 36W 230V Qty 1 pcs  |                 |  |
| <b>For models:</b>  | AEP-1402, AEP-1403, AEP-1404, AEP-1602, AEP-1603, AEP-1604, AEP-2103, AEP-701, AEP-801, AEP-802, AF-1602-MIX, AF-1603-C, AF-1603-P, AF-1604-C, AF-1604-P, AF-2104-C, AF-2104-P, AF-2105-C, AF-2105-P, AF-2106-C, AF-2106-P, AF-702-C, AF-702-P, AF-802-C, AF-802-P, AFP-1402, AFP-1403, AFP-1403-C, AFP-1403-P, AFP-1404, AFP-1404-C, AFP-1404-P, AFP-1602, AFP-1602-2, AFP-1603, AFP-1603-2, AFP-1604, AFP-2103, AFP-2104, AFP-2105, AFP-2106, AFP-701, AFP-702, AFP-801, AFP-802, AFP-802-2, AP-701, APP-701, VC-14-I, VC-14-M...(Other models you can see in the webshop) |                 |  |

oven lamps

producer-specific oven lamps

|   |   |                 |                     |
|---|---|-----------------|---------------------|
| <p>FAGOR</p>  |   |                 |                     |
| <b>GEV No.</b>  | 359433  | <b>Ref. No.</b> | 12017827<br>R660535 |
| <b>description</b>  | gasket  |                 |                     |
| <b>For models:</b>  | HCG-10-11, HCG-10-21, HCG-20-11, HCG-2-10-11, HCG-6-11, HME-10-11, HME-10-21, HME-20-11, HME-20-21, HME-2-10-11, HME-6-11, HMG-10-11, HMG-10-11UL, HMG-10-21, HMG-10-21UL, HMG-20-11, HMG-2-10-11, HMG-6-11, HMI-10-11, HMI-10-11UL, HMI-10-21, HMI-10-21UL, HMI-2-10-11, HMI-6-11, HMI-6-11UL, HMM-10-11, HMM-10-11UL, HMM-10-21, HMM-10-21UL, HMM-20-11, HMM-20-11UL, HMM-20-21, HMM-2-10-11, HMM-6-11, HMM-6-11UL, HMP-10-11, HMP-10-21, HMP-20-11, HMP-20-21, HMP-2-10-11, HMP-6-11 |                 |                     |

|  |  |                 |                     |
|--|--|-----------------|---------------------|
|  |  |                 |                     |
| <b>GEV No.</b>   | 359432   | <b>Ref. No.</b> | 12019933<br>R663058 |
| <b>description</b>   | lamp socket 25V socket G4 cable length 350mm connection male faston 4.8mm ømm H 18mm with 2 hole fixing mounting distance 16mm holder length 23mm Qty 1 pcs  |                 |                     |
| <b>For models:</b>   | HCG-10-11, HCG-10-21, HCG-20-11, HCG-20-21, HCG-2-10-11, HCG-2-20-11, HCG-6-11, HEI-20-11, HEM-20-11, HEP-20-11, HME-10-11, HME-10-21, HME-20-11, HME-20-21, HME-2-10-11, HME-2-20-11, HME-6-11, HMG-10-11, HMG-10-11UL, HMG-10-21, HMG-10-21UL, HMG-20-11, HMG-2-10-11, HMG-6-11, HMI-10-11, HMI-10-11UL, HMI-10-21, HMI-10-21UL, HMI-2-10-11, HMI-6-11, HMI-6-11UL, HMM-10-11, HMM-10-11UL, HMM-10-21, HMM-10-21UL, HMM-20-11, HMM-20-11UL, HMM-20-21, HMM-20-21UL, HMM-2-10-11, HMM-2-20-11, HMM-40-11-USMC, HMM-6-11, HMM-6-11UL, HMP-10-11, HMP-10-21, HMP-20-11, HMP-20-21, HMP-2-10-11, HMP-2-20-11...(Other models you can see in the webshop) |                 |                     |





Зип Общепит  
vsezip.ru  
+7(812)987 08 81

|   |  |                 |                     |
|---|--|-----------------|---------------------|
|  |  |                 |                     |
| <b>GEV No.</b>  | 359424   | <b>Ref. No.</b> | 12012381<br>R670608 |
| <b>description</b>  | frame L 75mm W 75mm mounting distance 61mm   |                 |                     |
| <b>For models:</b>  | HCG-10-11, HCG-10-21, HCG-20-11, HCG-20-21, HCG-2-10-11, HCG-2-20-11, HCG-6-11, HEI-20-11, HEM-20-11, HEP-20-11, HME-10-11, HME-10-21, HME-20-11, HME-20-21, HME-2-10-11, HME-2-20-11, HME-6-11, HMI-10-11, HMI-10-11UL, HMI-10-21, HMI-10-21UL, HMI-2-10-11, HMI-6-11, HMI-6-11UL, HMM-10-11, HMM-10-11UL, HMM-10-21, HMM-10-21UL, HMM-20-11, HMM-20-11UL, HMM-20-21, HMM-20-21UL, HMM-2-10-11, HMM-2-20-11, HMM-40-11-USMC, HMM-6-11, HMM-6-11UL, HMP-10-11, HMP-10-21, HMP-20-11, HMP-20-21, HMP-2-10-11, HMP-2-20-11, HMP-6-11, HVG-10-11, HVG-10-11UL, HVG-10-21, HVG-10-21UL, HVG-20-11, HVG-20-21...(Other models you can see in the webshop) |                 |                     |
| <b>accessories for</b>  | 359424   |                 |                     |
|  |  |                 |                     |
| <b>GEV No.</b>  | 359425   | <b>Ref. No.</b> | 12020892<br>R670609 |
| <b>description</b>  | gasket L 71mm W 71mm rubber thickness 1.5mm for oven lamp  |                 |                     |
|  |  |                 |                     |
| <b>GEV No.</b>  | 359426   | <b>Ref. No.</b> | 12016678<br>R670618 |
| <b>description</b>  | lamp glass L 38mm W 38mm thickness 3mm   |                 |                     |
|  |  |                 |                     |
| <b>GEV No.</b>  | 359432   | <b>Ref. No.</b> | 12019933<br>R663058 |
| <b>description</b>  | lamp socket 25V socket G4 cable length 350mm connection male faston 4.8mm ømm H 18mm with 2 hole fixing mounting distance 16mm holder length 23mm Qty 1 pcs  |                 |                     |

|  |  |                 |                     |
|--|--|-----------------|---------------------|
|  |  |                 |                     |
| <b>GEV No.</b>   | 359432   | <b>Ref. No.</b> | 12019933<br>R663058 |
| <b>description</b>   | lamp socket 25V socket G4 cable length 350mm connection male faston 4.8mm ømm H 18mm with 2 hole fixing mounting distance 16mm holder length 23mm Qty 1 pcs  |                 |                     |
| <b>For models:</b>   | HCG-10-11, HCG-10-21, HCG-20-11, HCG-20-21, HCG-2-10-11, HCG-2-20-11, HCG-6-11, HEI-20-11, HEM-20-11, HEP-20-11, HME-10-11, HME-10-21, HME-20-11, HME-20-21, HME-2-10-11, HME-2-20-11, HME-6-11, HMI-10-11, HMI-10-11UL, HMI-10-21, HMI-10-21UL, HMI-2-10-11, HMI-6-11, HMI-6-11UL, HMM-10-11, HMM-10-11UL, HMM-10-21, HMM-10-21UL, HMM-20-11, HMM-20-11UL, HMM-20-21, HMM-20-21UL, HMM-2-10-11, HMM-2-20-11, HMM-40-11-USMC, HMM-6-11, HMM-6-11UL, HMP-10-11, HMP-10-21, HMP-20-11, HMP-20-21, HMP-2-10-11, HMP-2-20-11, HMP-6-11, HVG-10-11, HVG-10-11UL, HVG-10-21, HVG-10-21UL, HVG-20-11, HVG-20-21...(Other models you can see in the webshop) |                 |                     |

|   |  |                 |                     |
|---|--|-----------------|---------------------|
|  |  |                 |                     |
| <b>GEV No.</b>  | 359425   | <b>Ref. No.</b> | 12020892<br>R670609 |
| <b>description</b>  | gasket L 71mm W 71mm rubber thickness 1.5mm for oven lamp  |                 |                     |
| <b>For models:</b>  | HCG-10-11, HCG-10-21, HCG-20-11, HCG-20-21, HCG-2-10-11, HCG-2-20-11, HCG-6-11, HEI-20-11, HEM-20-11, HEP-20-11, HME-10-11, HME-10-21, HME-20-11, HME-20-21, HME-2-10-11, HME-2-20-11, HME-6-11, HMI-10-11, HMI-10-11UL, HMI-10-21, HMI-10-21UL, HMI-2-10-11, HMI-6-11, HMI-6-11UL, HMM-10-11, HMM-10-11UL, HMM-10-21, HMM-10-21UL, HMM-20-11, HMM-20-11UL, HMM-20-21, HMM-20-21UL, HMM-2-10-11, HMM-2-20-11, HMM-40-11-USMC, HMM-6-11, HMM-6-11UL, HMP-10-11, HMP-10-21, HMP-20-11, HMP-20-21, HMP-2-10-11, HMP-2-20-11, HMP-6-11, HVG-10-11, HVG-10-11UL, HVG-10-21, HVG-10-21UL, HVG-20-11, HVG-20-21...(Other models you can see in the webshop) |                 |                     |

|  |  |                 |                     |
|--|--|-----------------|---------------------|
|  |  |                 |                     |
| <b>GEV No.</b>   | 359428   | <b>Ref. No.</b> | 12012053<br>R670610 |
| <b>description</b>   | reflector  |                 |                     |
| <b>For models:</b>   | HCG-10-11, HCG-10-21, HCG-20-11, HCG-20-21, HCG-2-10-11, HCG-2-20-11, HCG-6-11, HEI-20-11, HEM-20-11, HEP-20-11, HME-10-11, HME-10-21, HME-20-11, HME-20-21, HME-2-10-11, HME-2-20-11, HME-6-11, HMI-10-11, HMI-10-11UL, HMI-10-21, HMI-10-21UL, HMI-2-10-11, HMI-6-11, HMI-6-11UL, HMM-10-11, HMM-10-11UL, HMM-10-21, HMM-10-21UL, HMM-20-11, HMM-20-11UL, HMM-20-21, HMM-20-21UL, HMM-2-10-11, HMM-2-20-11, HMM-40-11-USMC, HMM-6-11, HMM-6-11UL, HMP-10-11, HMP-10-21, HMP-20-11, HMP-20-21, HMP-2-10-11, HMP-2-20-11, HMP-6-11, HVG-10-11, HVG-10-11UL, HVG-10-21, HVG-10-21UL, HVG-20-11, HVG-20-21...(Other models you can see in the webshop) |                 |                     |

|   |  |                 |                     |
|---|--|-----------------|---------------------|
|  |  |                 |                     |
| <b>GEV No.</b>  | 359426   | <b>Ref. No.</b> | 12016678<br>R670618 |
| <b>description</b>  | lamp glass L 38mm W 38mm thickness 3mm   |                 |                     |
| <b>For models:</b>  | HCG-10-11, HCG-10-21, HCG-20-11, HCG-20-21, HCG-2-10-11, HCG-2-20-11, HCG-6-11, HEI-20-11, HEM-20-11, HEP-20-11, HME-10-11, HME-10-21, HME-20-11, HME-20-21, HME-2-10-11, HME-2-20-11, HME-6-11, HMI-10-11, HMI-10-11UL, HMI-10-21, HMI-10-21UL, HMI-2-10-11, HMI-6-11, HMI-6-11UL, HMM-10-11, HMM-10-11UL, HMM-10-21, HMM-10-21UL, HMM-20-11, HMM-20-11UL, HMM-20-21, HMM-20-21UL, HMM-2-10-11, HMM-2-20-11, HMM-40-11-USMC, HMM-6-11, HMM-6-11UL, HMP-10-11, HMP-10-21, HMP-20-11, HMP-20-21, HMP-2-10-11, HMP-2-20-11, HMP-6-11, HVG-10-11, HVG-10-11UL, HVG-10-21, HVG-10-21UL, HVG-20-11, HVG-20-21...(Other models you can see in the webshop) |                 |                     |

|  |  |                 |                     |
|--|--|-----------------|---------------------|
|  |  |                 |                     |
| <b>GEV No.</b>   | 359423   | <b>Ref. No.</b> | 12024464<br>T303047 |
| <b>description</b>   | frame L 95mm W 80mm for oven lamp thickness 6mm  |                 |                     |
| <b>For models:</b>   | ACE-061, ACE-101, ACE-102, ACE-201, ACE-202, ACG-061, ACG-101, ACG-102, ACG-201, ACG-202, AE-061, AE-061W, AE-101, AE-101W, AE-102, AE-102W, AE-201, AE-202, AG-061, AG-061W, AG-101, AG-101W, AG-102, AG-102W, AG-201, AG-202, APE-061, APE-061W, APE-101, APE-101W, APE-102, APE-102W, APE-201, APE-202, APG-061, APG-061W, APG-101, APG-101W, APG-102, APG-102W, APG-201, APG-202, COE-061, COE-101, COE-102, COE-201, COE-202, COG-061, COG-101, COG-102...(Other models you can see in the webshop) |                 |                     |







Зип-Общепит



vsezip.ru

8(812)987-08-81

|   |  |                 |                     |
|---|--|-----------------|---------------------|
|  |  |                 |                     |
| 1   |  |                 |                     |
| <b>GEV No.</b>  | 359415   | <b>Ref. No.</b> | 12023532<br>T303027 |
| <b>description</b>  | gasket for oven lamp L 78mm W 62mm thickness 1mm graphite  |                 |                     |
| <b>For models:</b>  | ACE-061, ACE-101, ACE-102, ACE-201, ACE-202, ACG-061, ACG-101, ACG-102, ACG-201, ACG-202, AE-061, AE-061W, AE-101, AE-101W, AE-102, AE-102W, AE-201, AE-202, AG-061, AG-061W, AG-101, AG-101W, AG-102, AG-102W, AG-201, AG-202, APE-061, APE-061W, APE-101, APE-101W, APE-102, APE-102W, APE-201, APE-202, APG-061, APG-061W, APG-101, APG-101W, APG-102, APG-102W, APG-201, APG-202, COE-061, COE-101, COE-102, COE-201, COE-202, COG-061, COG-101, COG-102...(Other models you can see in the webshop) |                 |                     |

|   |  |                 |                     |
|---|--|-----------------|---------------------|
|  |  |                 |                     |
| 2   |  |                 |                     |
| <b>GEV No.</b>  | 359405   | <b>Ref. No.</b> | 12023578<br>T303026 |
| <b>description</b>  | gasket L 95mm W 80mm thickness 2mm graphite hole ø 5mm   |                 |                     |
| <b>For models:</b>  | ACE-061, ACE-101, ACE-102, ACE-201, ACE-202, ACG-061, ACG-101, ACG-102, ACG-201, ACG-202, AE-061, AE-061W, AE-101, AE-101W, AE-102, AE-102W, AE-201, AE-202, AG-061, AG-061W, AG-101, AG-101W, AG-102, AG-102W, AG-201, AG-202, APE-061, APE-061W, APE-101, APE-101W, APE-102, APE-102W, APE-201, APE-202, APG-061, APG-061W, APG-101, APG-101W, APG-102, APG-102W, APG-201, APG-202, COE-061, COE-101, COE-102, COE-201, COE-202, COG-061, COG-101, COG-102...(Other models you can see in the webshop) |                 |                     |

|   |  |                 |          |
|---|--|-----------------|----------|
|  |  |                 |          |
| 1   |  |                 |          |
| <b>GEV No.</b>  | 359408   | <b>Ref. No.</b> | 12023668 |
| <b>description</b>  | glass panel L 74mm W 59mm thickness 3mm  |                 |          |
| <b>For models:</b>  | ACE-061, ACE-101, ACE-102, ACE-201, ACE-202, ACG-061, ACG-101, ACG-102, ACG-201, ACG-202, AE-061, AE-061W, AE-101, AE-101W, AE-102, AE-102W, AE-201, AE-202, AG-061, AG-061W, AG-101, AG-101W, AG-102, AG-102W, AG-201, AG-202, APE-061, APE-061W, APE-101, APE-101W, APE-102, APE-102W, APE-201, APE-202, APG-061, APG-061W, APG-101, APG-101W, APG-102, APG-102W, APG-201, APG-202, COE-061, COE-101, COE-102, COE-201, COE-202, COG-061, COG-101, COG-102...(Other models you can see in the webshop) |                 |          |

|   |  |                 |                     |
|---|--|-----------------|---------------------|
|  |  |                 |                     |
| 1   |  |                 |                     |
| <b>GEV No.</b>  | 359295   | <b>Ref. No.</b> | 12024545<br>T303023 |
| <b>description</b>  | lamp socket for halogen lamp 12V 20W socket G4 mounting measurements 55 x 70mm cable length 135mm  |                 |                     |
| <b>For models:</b>  | ACE-061, ACE-101, ACE-102, ACE-201, ACE-202, ACG-061, ACG-101, ACG-102, ACG-201, ACG-202, AE-061, AE-061W, AE-101, AE-101W, AE-102, AE-102W, AE-201, AE-202, AG-061, AG-061W, AG-101, AG-101W, AG-102, AG-102W, AG-201, AG-202, APE-061, APE-061W, APE-101, APE-101W, APE-102, APE-102W, APE-201, APE-202, APG-061, APG-061W, APG-101, APG-101W, APG-102, APG-102W, APG-201, APG-202, COE-061, COE-101, COE-102, COE-201, COE-202, COG-061, COG-101, COG-102...(Other models you can see in the webshop) |                 |                     |
| <b>spare parts for</b>  | 359295   |                 |                     |
|  | <b>GEV No.</b>   | 359599          | <b>Ref. No.</b> —   |
| halogen lamp socket G4 12V 20W temp.-resist. 500°C                                  |  |                 |                     |

|   |        |                 |   |
|---|--------|-----------------|---|
| <b>accessories for</b> 359295                 |        |                 |   |
| <b>GEV No.</b>                                | 359296 | <b>Ref. No.</b> | — |
| lamp glass L 74mm W 58mm thickness 3mm        |        |                 |   |
| <b>GEV No.</b>                                | 551336 | <b>Ref. No.</b> | — |
| gasket for lamp L 92mm W 82mm thickness 2.3mm |        |                 |   |

**lamps**  
halogen lamps  
for socket G4 / G6.35 / G9

|   |   |                 |   |
|---|---|-----------------|---|
|  |   |                 |   |
| 1 <b>500°C</b>  |   |                 |   |
| <b>GEV No.</b>  | 359596  | <b>Ref. No.</b> | 12025123<br>12036215<br>R663013<br>RT30240201 |
| <b>description</b>  | halogen lamp socket G4 12V 10W temp.-resist. 500°C  |                 |   |
| <b>For models:</b>  | ACE-061, ACE-101, ACE-102, ACE-201, ACE-202, ACG-061, ACG-101, ACG-102, ACG-201, ACG-202, AE-061, AE-061W, AE-101, AE-101W, AE-102, AE-102W, AE-201, AE-202, AG-061, AG-061W, AG-101, AG-101W, AG-102, AG-102W, AG-201, AG-202, APE-061, APE-061W, APE-101, APE-101W, APE-102, APE-102W, APE-201, APE-202, APG-061, APG-061W, APG-101, APG-101W, APG-102, APG-102W, APG-201, APG-202, HCG-10-11, HCG-10-21, HCG-20-11, HCG-20-21, HCG-2-10-11, HCG-2-20-11, HCG-6-11, HEI-10-21...(Other models you can see in the webshop) |                 |   |

**lamp accessories**

**lenses**  
**glass panels**

|  |                                      |                 |          |
|--|--------------------------------------|-----------------|----------|
|  |                                      |                 |          |
| 1  |                                      |                 |          |
| <b>GEV No.</b>   | 699473                               | <b>Ref. No.</b> | 12037049 |
| <b>description</b>   | lamp glass L 135mm W 30mm half-round |                 |          |

**timers**

**programme timers**

|  |        |                 |         |
|--|--------|-----------------|---------|
|  |        |                 |         |
| 1  |        |                 |         |
| <b>GEV No.</b>   | 361353 | <b>Ref. No.</b> | Z683099 |
| <b>description</b>   | timer  |                 |         |

Зип Общепит

vsezip.ru

+7(812)987-08-81

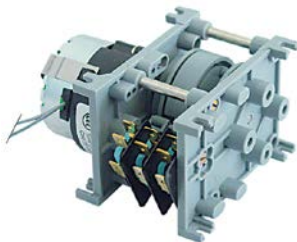

1

|                    |   |                 |                     |
|--------------------|---|-----------------|---------------------|
| <b>GEV No.</b>     | 361350  | <b>Ref. No.</b> | 12024867<br>Z613003 |
| <b>description</b> | timer CDC 4803F1 engines 1 chambers 3 operation time 20min 230V shaft ømm shaft Lmm   |                 |                     |
| <b>For models:</b> | CO-170-SOFT, CO-400-SOFT, CO-501-SOFT, FI-48, FI-48AR, FI-48B, FI-48B-BT-UK, FI-48C, FI-48D, FI-48HY-CLINIC, FI-48W, FI-64, FI-64AR, FI-64B, FI-64B-BT-UK, FI-64C, FI-64D, FI-64HY-CLINIC, FI-64W, LVC-15D, LVC-21D, LVR-14D, LVR-20D |                 |                     |



1

|                    |   |                 |                     |
|--------------------|---|-----------------|---------------------|
| <b>GEV No.</b>     | 360683  | <b>Ref. No.</b> | 12024571<br>Z713055 |
| <b>description</b> | timer CDC 4905DV engines 2 chambers 5 operation time 6s / 2min 230V shaft ømm shaft Lmm |                 |                     |
| <b>For models:</b> | FI-100, FI-100AR, FI-100B, FI-120, FI-120AR+DD, FI-120B, FI-120C, LABP-1000, LABP-1200  |                 |                     |



1

|   |  |                 |                        |
|---|--|-----------------|------------------------|
| <b>GEV No.</b>  | 360525   | <b>Ref. No.</b> | 12030573<br>BR00023247 |
| <b>description</b>  | timer CDC 11904 engines 1 chambers 4 operation time 10min 230V shaft ømm shaft Lmm manuf. no. 11904F1 / BCR000.0000 motor type M48R ATS                        |                 |                        |
| <b>spare parts for</b>  | 360525   |                 |                        |
|  | <b>GEV No.</b>   | 360118          | <b>Ref. No.</b> —      |
|   | motor CDC pinion ø 4.9mm teeth 10 230V voltage AC 50/60Hz turn direction right motor ø 47mm H 19.3mm motor type M48R ATS for timer cable length 260mm 1.9/2.5W |                 |                        |



1

|                    |  |                 |          |
|--------------------|--|-----------------|----------|
| <b>GEV No.</b>     | 360696   | <b>Ref. No.</b> | 12023458 |
| <b>description</b> | timer CDC 4906DV engines 2 chambers 6 operation time 6s / 2min 230V 50Hz shaft ømm shaft Lmm manuf. no. 4906DV0AOE000.1010 |                 |          |



1

|                    |  |                 |                        |
|--------------------|--|-----------------|------------------------|
| <b>GEV No.</b>     | 360566   | <b>Ref. No.</b> | 12030499<br>BR00023259 |
| <b>description</b> | timer CDC 11904 engines 1 chambers 4 operation time 15min 115V 60Hz shaft ømm shaft Lmm manuf. no. 11904F1BEI000.0010 motor type M48R ATS voltage AC |                 |                        |



1

|                    |  |                 |                     |
|--------------------|--|-----------------|---------------------|
| <b>GEV No.</b>     | 360441   | <b>Ref. No.</b> | 12023466<br>Z728412 |
| <b>description</b> | timer CDC 4906DV engines 2 chambers 6 operation time 6s / 2min 230V 60Hz shaft ømm shaft Lmm manuf. no. 4906DV0ADY000.0000 |                 |                     |
| <b>For models:</b> | FI-120W, MF-120  |                 |                     |



1

|                    |   |                 |                     |
|--------------------|---|-----------------|---------------------|
| <b>GEV No.</b>     | 361358  | <b>Ref. No.</b> | 12017510<br>Z728302 |
| <b>description</b> | timer CDC 4905DV engines 2 chambers 5 operation time 6s / 2min 230V 60Hz shaft ømm shaft Lmm motor type M48R ATS / M48L ATS |                 |                     |
| <b>For models:</b> | ECO-120, ECO-120B, FI-100, FI-100AR, FI-100B, FI-120, FI-120B, FI-120W, MF-120  |                 |                     |



1

|                    |   |                 |                     |
|--------------------|---|-----------------|---------------------|
| <b>GEV No.</b>     | 361357  | <b>Ref. No.</b> | 12024873<br>Z433002 |
| <b>description</b> | timer CDC 7803 engines 1 chambers 3 operation time 120s 230V shaft ømm shaft Lmm motor type M37LN   |                 |                     |
| <b>For models:</b> | CO-350, CO-350-B, CO-350-B-DD, CO-350-COLD, CO-350-COLD-B, CO-350-COLD-B-DD, CO-350-COLD-DD, CO-350-DD, CO-400, CO-400-B, CO-400-B-DD, CO-400-COLD, CO-400-COLD-B, CO-400-COLD-B-DD, CO-400-COLD-DD, CO-400-DD, CO-400-SOFT, EASY-500, EASY-500B, EASY-500DD, LVC-21B, LVC-21C, LVR-20, LVR-20B |                 |                     |

Зип Общепит

vsezip.ru

+7(812)987-08-81



1

|                    |  |                 |                     |
|--------------------|--|-----------------|---------------------|
| <b>GEV No.</b>     | 360586   | <b>Ref. No.</b> | 12017931<br>R763006 |
| <b>description</b> | timer CDC 7803 engines 1 chambers 3 operation time 240s 230V shaft ømm shaft Lmm motor type M37LN type 7903F3 voltage AC                             |                 |                     |
| <b>For models:</b> | HEI-10-11, HEI-20-11, HEI-6-11, HEM-10-11, HEM-20-11, HEM-6-11, HEP-10-11, HEP-20-11, HEP-6-11, HGC-10-11, HGC-20-11, HGC-6-11, HGV-10-11, HGV-20-11 |                 |                     |



1

|                    |  |                 |                     |
|--------------------|--|-----------------|---------------------|
| <b>GEV No.</b>     | 360438   | <b>Ref. No.</b> | 12024202<br>Z258412 |
| <b>description</b> | timer CDC 7805DV engines 2 chambers 5 operation time 6s / 3min 230V 60Hz shaft ømm shaft Lmm |                 |                     |
| <b>For models:</b> | FI-48W, FI-64B, FI-64W, FI-72, FI-72W, FI-80BBT-UK, FI-80W, MF-48, MF-64                     |                 |                     |



1

|                    |  |                 |                     |
|--------------------|--|-----------------|---------------------|
| <b>GEV No.</b>     | 361354   | <b>Ref. No.</b> | 12024178<br>Z213008 |
| <b>description</b> | timer CDC 7804DV engines 2 chambers 4 operation time 6s / 3min 230V shaft ømm shaft Lmm motor type M37RN/M37LN |                 |                     |
| <b>For models:</b> | FI-48, FI-48B, FI-48D, FI-48W  |                 |                     |



1

|                    |  |                 |                     |
|--------------------|--|-----------------|---------------------|
| <b>GEV No.</b>     | 360439   | <b>Ref. No.</b> | 12024204<br>Z243001 |
| <b>description</b> | timer CDC 7805DV engines 2 chambers 5 operation time 6s/180s 230V 50Hz shaft ømm shaft Lmm               |                 |                     |
| <b>For models:</b> | EASY-500HPWBDD, FI-48, FI-48B, FI-48W, FI-64, FI-64B, FI-64B-BT-UK, FI-64HY-CLINIC, FI-64W, MF-48, MF-64 |                 |                     |



1

|                    |  |                 |                     |
|--------------------|--|-----------------|---------------------|
| <b>GEV No.</b>     | 361355   | <b>Ref. No.</b> | 12024177<br>Z243004 |
| <b>description</b> | timer CDC 7804DV engines 2 chambers 4 operation time 6s / 3min 230V shaft ømm shaft Lmm motor type M37RN/M37LN |                 |                     |
| <b>For models:</b> | EASY-500HP, FI-64, FI-64AR, FI-64B, FI-64C, FI-64D, FI-72, FI-72AR, FI-80, FI-80AR, LABP-800                   |                 |                     |



1

|                    |   |                 |                     |
|--------------------|---|-----------------|---------------------|
| <b>GEV No.</b>     | 361352  | <b>Ref. No.</b> | 12024089<br>Z403002 |
| <b>description</b> | timer CDC 7903F engines 1 chambers 3 operation time 120s 230V shaft ø 6x4.6mm shaft L 13mm dishwasher |                 |                     |
| <b>For models:</b> | LVC-12, LVC-15, LVC-15D, LVC-21, LVC-21D, LVC-21W, LVR-10, LVR-14, LVR-14D, LVR-20, LVR-20D           |                 |                     |



1

|                    |   |                 |                     |
|--------------------|---|-----------------|---------------------|
| <b>GEV No.</b>     | 360440  | <b>Ref. No.</b> | 12024203<br>Z213002 |
| <b>description</b> | timer CDC 7805DV engines 2 chambers 5 operation time 6s / 3min 230V 50Hz shaft ømm shaft Lmm                      |                 |                     |
| <b>For models:</b> | FI-48, FI-48AR, FI-48B, FI-48B-BT-UK, FI-48C, FI-48D, FI-48HY-CLINIC, FI-48W, FI-64, FI-64B, FI-64W, MF-48, MF-64 |                 |                     |



1

|                    |  |                 |  |
|--------------------|--|-----------------|--|
| <b>GEV No.</b>     | 361351   | <b>Ref. No.</b> | 12017667<br>12024087<br>Z203030<br>Z268302 |
| <b>description</b> | timer CDC 7903F engines 1 chambers 3 operation time 4min 230V shaft ø 6x4.6mm shaft L 13mm                       |                 |  |
| <b>For models:</b> | FI-30, FI-30AR, FI-30AR+DD, FI-30B, FI-30B-BT-UK, FI-30-UK, FI-60DD, FI-64, FI-64B, FI-64W, FI-72, FI-80, FI-80W |                 |  |

Зип Общепит

vsezip.ru

+7(812)987-08-81



1

|   |  |                 |                    |
|---|--|-----------------|--------------------|
| <b>GEV No.</b>  | 360557   | <b>Ref. No.</b> | 12095827<br>IT4864 |
| <b>description</b>  | timer FIBER P19 engines 1 chambers 2 operation time 15min 230V shaft ømm shaft Lmm manif. no. P195JE2J730 motor type M51B-J0L6400 cable length 250mm voltage AC          |                 |                    |
| <b>For models:</b>  | FIM-110A, FIM-110W, FIM-150A, FIM-150W, FIM-20A, FIM-20W, FIM-30A, FIM-30W, FIM-40A, FIM-40W, FIM-55A, FIM-55W, FIM-80A, FIM-80W   |                 |                    |
| <b>spare parts for</b>  | 360557   |                 |                    |
|   | <b>GEV No.</b>   | <b>Ref. No.</b> | —                  |
|  | motor kit pinion ø 6.8mm teeth 15 230V voltage AC 50/60Hz turn direction counterclockwise motor ø 48mm H 18.5mm motor type UDS40NE1RNZ165 cable length 150mm with holder |                 |                    |



|                    |   |                 |                     |
|--------------------|---|-----------------|---------------------|
| <b>GEV No.</b>     | 361356  | <b>Ref. No.</b> | 12017561<br>Z703004 |
| <b>description</b> | timer M48L ATS engines 2 chambers 5 operation time 6s / 2min 230V shaft ømm shaft Lmm |                 |                     |
| <b>For models:</b> | ECO-120, ECO-1200, ECO-120B   |                 |                     |

mechanical timers



1

|   |  |                 |  |
|---|--|-----------------|--|
| <b>GEV No.</b>  | 360154   | <b>Ref. No.</b> | 12029594<br>12030574<br>BR00023222<br>BR00023248 |
| <b>description</b>  | timer FIBER P20 engines 1 chambers 4 operation time 15min 230V shaft ømm shaft Lmm manif. no. P205J04J714 motor type M51B-J0R6400                                  |                 |  |
| <b>spare parts for</b>  | 360154   |                 |  |
|   | <b>GEV No.</b>   | <b>Ref. No.</b> | —  |
|  | motor kit pinion ø 6.8mm teeth 15 230V voltage AC 50/60Hz turn direction clockwise motor ø 48mm H 18.5mm motor type UDS-40NE1RNZ165 cable length 150mm with holder |                 |  |



1

|                    |   |                 |                     |
|--------------------|---|-----------------|---------------------|
| <b>GEV No.</b>     | 350066  | <b>Ref. No.</b> | 12018407<br>R723000 |
| <b>description</b> | timer C20 2-pole operation time 120min impulse mechanical 1NO/1NC at 250V 16A permanent position yes shaft ø 6x4.6mm shaft 6x4.6mm shaft L 23mm mounting distance 28mm connection lateral   |                 |                     |
| <b>For models:</b> | HCG-10-11, HCG-10-21, HCG-20-11, HCG-20-21, HCG-2-10-11, HCG-2-20-11, HCG-6-11, HEI-10-11, HEI-20-11, HEI-6-11, HGC-10-11, HGC-20-11, HGC-6-11, HGV-10-11, HGV-20-11, HME-20-11, HMG-10-11, HMG-10-11UL, HMG-10-21, HMG-10-21UL, HMG-20-11, HMG-2-10-11, HMG-6-11, HMI-10-11, HMI-10-11UL, HMI-10-21, HMI-10-21UL, HMI-2-10-11, HMI-6-11, HMI-6-11UL, HMM-10-11, HMM-10-11UL, HMM-10-21, HMM-10-21UL, HMM-20-11, HMM-20-11UL, HMM-20-21, HMM-20-21UL, HMM-2-10-11, HMM-40-11-USMC, HMM-6-11, HMM-6-11UL, HMP-20-11, HVG-10-11, HVG-10-11UL, HVG-10-21, HVG-10-21UL, HVG-20-11, HVG-20-21, HVG-2-10-11...(Other models you can see in the webshop) |                 |                     |



1

|                    |  |                 |                                   |
|--------------------|--|-----------------|-----------------------------------|
| <b>GEV No.</b>     | 360532   | <b>Ref. No.</b> | 12023458 (old version)<br>Z718937 |
| <b>description</b> | timer FIBER P25 engines 2 chambers 6 operation time 6s / 2min 230V 50Hz shaft ømm shaft Lmm manif. no. P255J06JDU2 motor type M51BJ0L0000/M51BJ0R0000 voltage AC |                 |                                   |



1

|                    |   |                 |  |
|--------------------|---|-----------------|--|
| <b>GEV No.</b>     | 360732  | <b>Ref. No.</b> | 12030066<br>12049916<br>DO1DI13315<br>DO1DL13350 |
| <b>description</b> | timer MT59 2-pole operation time 60min impulse mechanical 2NO at 250V 16A permanent position no shaft ø 6x4.6mm shaft L 21mm mounting distance 28mm connection lateral shaft flat lower |                 |  |
| <b>For models:</b> | SF-10, SF-13, SF-15, SF-22, SF-31, SF-8, SR-10MP-PSM, SR-13MP-PSM, SR-32MP-PSM  |                 |  |



Зип-Общепит

contactors

ABB  
vsezip.ru  
power contactors

+7(812)987-08-81

|  |   |                 |                        |
|--|---|-----------------|------------------------|
|  <p>1</p> |   |                 |                        |
| <b>GEV No.</b>   | 360447  | <b>Ref. No.</b> | 12029415<br>K017C21101 |
| <b>description</b>   | timer T203 1-pole operation time 5min impulse mechanical 1NO at 250V 16(3)A permanent position no shaft ø 6x4.6mm shaft 6x4.6mm shaft L 16mm mounting distance 30mm connection rear ambient temperature max. 55°C |                 |                        |

## alarm devices

### buzzer boards

|  |  |                 |                     |
|--|--|-----------------|---------------------|
|  <p>1</p> |  |                 |                     |
| <b>GEV No.</b>   | 400879   | <b>Ref. No.</b> | 12018224<br>R723033 |
| <b>description</b>   | buzzer board connection connector  |                 |                     |
| <b>For models:</b>   | HCG-10-11, HCG-10-21, HCG-20-11, HCG-2-10-11, HCG-6-11, HMG-10-11, HMG-10-11UL, HMG-10-21, HMG-10-21UL, HMG-20-11, HMG-2-10-11, HMG-6-11 |                 |                     |

### buzzers

|  |   |                 |                                    |
|--|---|-----------------|------------------------------------|
|  <p>1</p> |   |                 |                                    |
| <b>GEV No.</b>   | 350053  | <b>Ref. No.</b> | 12032927<br>12033283<br>RT30060107 |
| <b>description</b>   | buzzer 12VAC connection male faston 3.2mm screw mounting buzzer |                 |                                    |

|  |  |                 |                     |
|--|--|-----------------|---------------------|
|  <p>1</p> |  |                 |                     |
| <b>GEV No.</b>   | 350067   | <b>Ref. No.</b> | 12018850<br>R693067 |
| <b>description</b>   | buzzer buzzer  |                 |                     |
| <b>For models:</b>   | HCG-10-11, HCG-10-21, HCG-20-11, HCG-20-21, HCG-2-10-11, HCG-2-20-11, HCG-6-11, HEI-10-11, HEI-20-11, HEI-6-11, HGC-10-11, HGC-20-11, HGC-6-11, HGV-10-11, HGV-20-11, HMG-20-11, HMI-10-11, HMI-10-11UL, HMI-10-21, HMI-10-21UL, HMI-2-10-11, HMI-6-11, HMI-6-11UL, HMM-10-11, HMM-10-11UL, HMM-10-21, HMM-10-21UL, HMM-20-11, HMM-20-11UL, HMM-20-21, HMM-20-21UL, HMM-2-10-11, HMM-40-11-USMC, HMM-6-11, HMM-6-11UL, HVG-10-11, HVG-10-21, HVG-20-11, HVG-20-21, HVG-2-10-11, HVG-2-20-21, MFHMM-20-11 |                 |                     |

|   |  |                 |            |
|---|--|-----------------|------------|
|  <p>1</p> |  |                 |            |
| <b>GEV No.</b>  | 380117   | <b>Ref. No.</b> | SAM2600123 |
| <b>description</b>  | power contactor resistive load 25A 230VAC (AC3/400V) 9A/4kW main contacts 4NO auxiliary contacts connection screw connection type A9-40-00 |                 |            |

|   |   |                 |   |
|---|---|-----------------|---|
|  <p>1</p> |   |                 |   |
| <b>GEV No.</b>  | 381175  | <b>Ref. No.</b> | 12024040 (old version)<br>Z203050 (old version) |
| <b>description</b>  | power contactor resistive load 22A 230VAC (AC3/400V) 5.5kW main contacts 3NO auxiliary contacts 1NO connection plug-in connection type AS12-30-10S-26 50/60Hz |                 |   |

## BENEDIKT & JÄGER

### power contactors

|   |   |                 |                        |
|---|---|-----------------|------------------------|
|  <p>1</p> |   |                 |                        |
| <b>GEV No.</b>  | 381501  | <b>Ref. No.</b> | 12030536<br>RT30280557 |
| <b>description</b>  | power contactor resistive load 32A 230VAC (AC3/400V) 17A/7.5kW main contacts 3NO auxiliary contacts 1NC connection screw connection |                 |                        |

1 electric components



Зип Общепит

vsezip.ru

+7(812)987-08-81



1

|                    |   |                 |                        |
|--------------------|---|-----------------|------------------------|
| <b>GEV No.</b>     | 382001  | <b>Ref. No.</b> | 12030415<br>RT30280569 |
| <b>description</b> | power contactor resistive load 32A 230VAC (AC3/400V) 17A/7.5kW main contacts 4NO auxiliary contacts connection screw connection |                 |                        |

## GENERAL ELECTRIC (AEG)



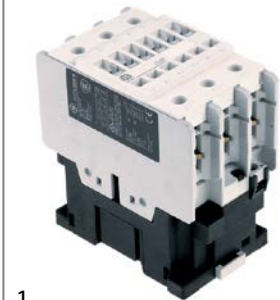

## power contactors



1

|                    |  |                 |                       |
|--------------------|--|-----------------|-----------------------|
| <b>GEV No.</b>     | 380267   | <b>Ref. No.</b> | 12027712<br>RT4001558 |
| <b>description</b> | power contactor resistive load 110A 230VAC (AC3/400V) 65A/30kW main contacts 3NO auxiliary contacts connection screw connection type AEG LS30K 00A type GE CL07A 300 |                 |                       |

**accessories for** 380267

|   |  |        |                 |                        |
|---|--|--------|-----------------|------------------------|
|  | <b>GEV No.</b>   | 380268 | <b>Ref. No.</b> | 12034954<br>RT30280560 |
|   | auxiliary contact contacts 1NO for contactors CL+LS_K connection screw AC-12 10A type AEG HS07K 10 type GE BCLF 10         |        |                 |                        |
|  | <b>GEV No.</b>   | 380269 | <b>Ref. No.</b> | 12035138<br>RT30280561 |
|   | auxiliary contact contacts 1NC AC15 6A for contactors CL+LS_K connection screw AC-12 10A type AEG HS07K 01 type GE BCLF 01 |        |                 |                        |
|  | <b>GEV No.</b>   | 380270 | <b>Ref. No.</b> | —                      |
|   | auxiliary contact contacts 1NO/1NC for contactors CL+LS_K connection screw AC-12 10A type AEG HS08K 11 type GE BCLL 11     |        |                 |                        |
|  | <b>GEV No.</b>   | 380271 | <b>Ref. No.</b> | —                      |
|   | auxiliary contact contacts 2NO for contactors CL+LS_K connection screw AC-12 10A type AEG HS08K 20 type GE BCLL 20         |        |                 |                        |



1

|                    |   |                 |                     |
|--------------------|---|-----------------|---------------------|
| <b>GEV No.</b>     | 380237  | <b>Ref. No.</b> | 12024011<br>Z213007 |
| <b>description</b> | power contactor resistive load 16A 230VAC (AC3/400V) 6A/3kW main contacts 3NO auxiliary contacts 1NC connection male faston 6.3mm type AEG LS0701F  |                 |                     |
| <b>For models:</b> | ACE-061, ACE-101, ACE-102, ACE-201, ACE-202, ACG-061, ACG-101, ACG-102, ACG-201, ACG-202, AD-125, AD-125HRS, AD-125-SOFT, AD-15, AD-15D, AD-21, AD-21B, AD-21BDD, AD-21D, AD-21W, AD-505, AD-505-SOFT, AD-64BTDD, AE-061, AE-061W, AE-101, AE-101W, AE-102, AE-102W, AE-201, AE-202, AG-061, AG-061W, AG-101, AG-101W, AG-102, AG-102W, AG-201, AG-202, APE-061, APE-061W, APE-101, APE-101W, APE-102, APE-102W, APE-201, APE-202, APG-061, APG-061W, APG-101...(Other models you can see in the webshop) |                 |                     |



1

|                    |  |                 |                       |
|--------------------|--|-----------------|-----------------------|
| <b>GEV No.</b>     | 380498   | <b>Ref. No.</b> | 12030013<br>RT4000451 |
| <b>description</b> | power contactor resistive load 20A 230VAC (AC3/400V) 9A/4kW main contacts 4NO auxiliary contacts connection male faston 6.3mm type MC1A 400A type AEG LS05 01 FA type GE MC1A 400A |                 |                       |



1

|                    |   |                 |                        |
|--------------------|---|-----------------|------------------------|
| <b>GEV No.</b>     | 380245  | <b>Ref. No.</b> | 12031082<br>RT30280550 |
| <b>description</b> | power contactor resistive load 25A 230VAC (AC3/400V) 9A/4kW main contacts 3NO auxiliary contacts 1NC connection screw connection type AEG LS4K 01A type GE CL00A 301 H 85mm |                 |                        |



Зип Общедит

auxiliary contacts

vsezip.ru

+7(812)987-08-81



1

|                    |  |                 |   |
|--------------------|--|-----------------|---|
| <b>GEV No.</b>     | 380244   | <b>Ref. No.</b> | 12018159<br>12027320<br>12029911<br>12031081<br>R663031<br>RT30280551<br>RT4001554<br>RT4001556 |
| <b>description</b> | power contactor resistive load 25A 230VAC (AC3/400V) 9A/4kW main contacts 3NO auxiliary contacts 1NO connection screw connection type AEG LS4K 10A type GE CL00A 310   |                 |   |
| <b>For models:</b> | ECO-1600, ECO-160D, ECO-160I, ECO-200D, ECO-200HD, ECO-200HI, ECO-200I, ECO-2300, ECO-280D, ECO-280I, ECO-3000, ECO-370D, ECO-370I, ECO-460D, ECO-460I, ECO-550D, ECO-550I, FE-18, FE-25, FE-710, FI-120, FI-120B, FI-1600, FI-160D, FI-160I, FI-200D, FI-200HD, FI-200HI, FI-200I, FI-2300, FI-280D, FI-280I, FI-3000, FI-370D, FI-370I, FI-460D, FI-460I, FI-550D, FI-550I, HME-10-11, HME-10-21, HME-20-11, HME-20-21, HME-2-10-11, HME-6-11, HMI-10-11, HMI-10-11UL, HMI-10-21, HMI-10-21UL, HMI-2-10-11...(Other models you can see in the webshop) |                 |   |



2

|                    |   |                 |   |
|--------------------|---|-----------------|---|
| <b>GEV No.</b>     | 380261  | <b>Ref. No.</b> | 12028282<br>12029618<br>12030540<br>ICR13042<br>RT30280552<br>RT4001555 |
| <b>description</b> | power contactor resistive load 32A 230VAC (AC3/400V) 17A/7.5kW main contacts 3NO auxiliary contacts 1NO connection screw connection type AEG LS7K 10A type GE CL02A 310 |                 |   |



1

|                    |  |                 |                        |
|--------------------|--|-----------------|------------------------|
| <b>GEV No.</b>     | 380265   | <b>Ref. No.</b> | 12028308<br>RT30280554 |
| <b>description</b> | power contactor resistive load 60A 230VAC (AC3/400V) 32A/16kW main contacts 3NO auxiliary contacts 1NO connection screw connection type AEG LS15K 00A type GE CL04A 310 H 98mm L 87mm W 55mm |                 |                        |



|                    |  |                 |                        |
|--------------------|--|-----------------|------------------------|
| <b>GEV No.</b>     | 380269   | <b>Ref. No.</b> | 12035138<br>RT30280561 |
| <b>description</b> | auxiliary contact contacts 1NC AC15 6A for contactors CL+LS_K connection screw AC-12 10A type AEG HS07K 01 type GE BCLF 01 |                 |                        |

1



|                    |  |                 |                        |
|--------------------|--|-----------------|------------------------|
| <b>GEV No.</b>     | 380268   | <b>Ref. No.</b> | 12034954<br>RT30280560 |
| <b>description</b> | auxiliary contact contacts 1NO for contactors CL+LS_K connection screw AC-12 10A type AEG HS07K 10 type GE BCLF 10 |                 |                        |

ISKRA (FANAL)

power contactors



1

|                    |  |                 |                     |
|--------------------|--|-----------------|---------------------|
| <b>GEV No.</b>     | 380212   | <b>Ref. No.</b> | 12000219<br>P453023 |
| <b>description</b> | power contactor resistive load 20A 230VAC (AC3/400V) 8.5A/5.5kW main contacts 3NO auxiliary contacts 1NC connection screw connection type Fanal K07M 01 type ISKRA DSL7 01 |                 |                     |
| <b>For models:</b> | FE-6, FE-8, FI-300B, FI-300R, FI-650R  |                 |                     |

electric components



SIEMENS

power contactors



1

|                    |   |                 |                                 |
|--------------------|---|-----------------|---------------------------------|
| <b>GEV No.</b>     | 380614  | <b>Ref. No.</b> | 12024040<br>12111795<br>Z203050 |
| <b>description</b> | power contactor resistive load 22A 230VAC (AC3/400V) 9A/4kW main contacts 3NO auxiliary contacts 1NO connection elastic terminals type 3RT2016-2AP01  |                 |                                 |
| <b>For models:</b> | ACE-061, ACE-101, AD-120, AD-120B, AD-120BBTDD-UK, AD-120C, AD-120CW, AD-120HY, AD-125, AD-125HRS, AD-125-SOFT, AD-90, AD-90BA, AD-90BBT, AD-90BDD, AD-90DD, ADE-120, ADE-120B, AE-061, AE-061W, AE-101, AE-101W, APE-061, APE-061W, APE-101, APE-101W, CO-110, CO-110B, CO-110BDD, CO-110DD, CO-112, CO-112B, CO-112BDD, CO-112DD, CO-142W, CO-142WDD, CO-170, CO-170B, CO-170BDD, CO-170DD, CO-170HRS, CO-170HRSDD, CO-170HRS-SOFT, CO-170-SOFT, CO-172, CO-172B, CO-172BDD, CO-172DD, COE-061, COE-101...(Other models you can see in the webshop) |                 |                                 |



2

|                    |   |                 |  |
|--------------------|---|-----------------|--|
| <b>GEV No.</b>     | 380389  | <b>Ref. No.</b> | 12018160<br>12024039<br>P433030<br>Z743009 |
| <b>description</b> | power contactor resistive load 22A 230VAC (AC3/400V) 9A/4kW main contacts 3NO auxiliary contacts 1NO connection screw connection type 3RT10-16-1AP01  |                 |  |
| <b>For models:</b> | ECO-160, ECO-200, ECO-200D, ECO-200H, ECO-200HD, ECO-200HI, ECO-200I, ECO-2700D, ECO-2700I, ECO-280D, ECO-280I, ECO-370D, ECO-370I, ECO-4000D, ECO-4000I, ECO-460D, ECO-460I, ECO-550D, ECO-550I, ECO-6000D, ECO-6000I, FI-120W, FI-160, FI-160AR, FI-160D, FI-160I, FI-200, FI-200AR, FI-200D, FI-200H, FI-200HD, FI-200HI, FI-200I, FI-200W, FI-2700D, FI-2700I, FI-280D, FI-280I, FI-370D, FI-370I, FI-4000D, FI-4000I, FI-460D, FI-460I, FI-48, FI-48AR, FI-48B, FI-48B-BT-UK, FI-48C, FI-48D...(Other models you can see in the webshop) |                 |  |

Зип Общепит

vsezip.ru

+7(812)987-08-81



1

|                    |  |                 |   |
|--------------------|--|-----------------|---|
| <b>GEV No.</b>     | 380390   | <b>Ref. No.</b> | 12024075<br>12039754<br>12040142<br>R143002<br>R673007<br>X183011 |
| <b>description</b> | power contactor resistive load 40A 230VAC (AC3/400V) 12A/5.5kW main contacts 3NO auxiliary contacts connection screw connection type 3RT10-24-1AL20 50/60Hz  |                 |   |
| <b>For models:</b> | COE-102, COE-201, ECO-160, ECO-1600, ECO-160D, ECO-160I, ECO-200, ECO-200D, ECO-200H, ECO-200HD, ECO-200HI, ECO-200I, ECO-2300, ECO-2700D, ECO-2700I, ECO-280D, ECO-280I, ECO-3000, ECO-370D, ECO-370I, ECO-4000D, ECO-4000I, ECO-460D, ECO-460I, ECO-550D, ECO-550I, ECO-6000D, ECO-6000I, FE9-05, FE9-05-1C, FE9-05-2C, FE9-05AD, FE9-05PLUS, FE9-05PLUS-S, FE9-05S, FE9-05S-1C, FE9-05S-2C, FE9-05S-AD, FE9-05USMC, FE9-10, FE9-10-2C, FE9-10-4C, FE9-10AD, FE9-10PLUS, FE-920, FI-160, FI-1600, FI-160AR, FI-160D, FI-160I...(Other models you can see in the webshop) |                 |   |



1

|                    |  |                 |          |
|--------------------|--|-----------------|----------|
| <b>GEV No.</b>     | 381543   | <b>Ref. No.</b> | 12041014 |
| <b>description</b> | power contactor resistive load 40A 230VAC (AC3/400V) 5.5kW main contacts 3NO auxiliary contacts 1NO/1NC connection plug-in connection type 3RT2024-2AL20 |                 |          |
| <b>For models:</b> | ACE-102, ACE-201, AE-102, AE-102W, AE-201, APE-102, APE-102W, APE-201, LA-E-25M, LA-E-25MA, LA-E-25MP, LR-E-25M, LR-E-25MA, LR-E-25MP                    |                 |          |





Зип.Общепит  
relays

vsezip.ru

with DIN rail mounting

upper

+7(812)987-08-81

auxiliary contacts



|                    |  |                 |                     |
|--------------------|--|-----------------|---------------------|
| <b>GEV No.</b>     | 380539   | <b>Ref. No.</b> | 12023704<br>Z103070 |
| <b>description</b> | auxiliary contact contacts 1NO AC15 3A for contactors 3RT102 3 RT103 connection screw connection type 3RH1921-1CA10 resistive load 10A AC-12 10A   |                 |                     |
| <b>For models:</b> | ECO-160, ECO-1600, ECO-160D, ECO-160I, ECO-200, ECO-200D, ECO-200H, ECO-200HD, ECO-200HI, ECO-200I, ECO-2300, ECO-2700D, ECO-2700I, ECO-280D, ECO-280I, ECO-3000, ECO-370D, ECO-370I, ECO-4000D, ECO-4000I, ECO-460D, ECO-460I, ECO-550D, ECO-550I, ECO-6000D, ECO-6000I, FI-160, FI-1600, FI-160AR, FI-160D, FI-160I, FI-200, FI-200AR, FI-200D, FI-200H, FI-200HD, FI-200HI, FI-200I, FI-200W, FI-2300, FI-2700D, FI-2700I, FI-280D, FI-280I, FI-3000, FI-370D, FI-370I, FI-4000D, FI-4000I, FI-460D...(Other models you can see in the webshop) |                 |                     |

small relay switches



|                    |   |                 |                     |
|--------------------|---|-----------------|---------------------|
| <b>GEV No.</b>     | 380696  | <b>Ref. No.</b> | 12024012<br>Z683087 |
| <b>description</b> | small relay switch 230V (AC3/400V) 9A/4kW main contacts 3NO auxiliary contacts 1NC connection male faston 6.3mm resistive load 16A  |                 |                     |
| <b>For models:</b> | AD-15, AD-15D, AD-20C-UK, AD-21, AD-21B, AD-21BDD, AD-21C, AD-21D, AD-21DD, AD-48, AD-48BDD, AD-48C, AD-48D, AD-48DD, AD-64, AD-64B, AD-64BDD, AD-64C, AD-64D, AD-64DD, AD-72, CO-110, CO-110B, CO-110BDD, CO-110DD, CO-112, CO-112B, CO-112BDD, CO-112DD, CO-170, CO-170B, CO-170BDD, CO-170DD, CO-170HRS, CO-170HRSDD, CO-170HRS-SOFT, CO-170-SOFT, CO-172, CO-172B, CO-172BDD, CO-172DD, COP-173, COP-173B, COP-173BDD, COP-173DD, COP-173HRS, COP-173HRSDD, COP-173-SOFT, COP-174, COP-174B...(Other models you can see in the webshop) |                 |                     |

solid state relays

CELDUC



|                        |   |                 |   |
|------------------------|---|-----------------|---|
| <b>GEV No.</b>         | 400105  | <b>Ref. No.</b> | 12028184<br>12029297<br>12029298<br>RT30280533<br>RT4000453<br>RT4000453P |
| <b>description</b>     | solid state relay CELDUC 2 phase 65A 400V 24VDC L 58mm W 45mm plug-in connection screw type 40.00.453 |                 |   |
| <b>accessories for</b> | 400105  |                 |   |
|                        | <b>GEV No.</b>  | 401794          | <b>Ref. No.</b> —   |
|                        | connecting cable L 1440mm 4-pole suitable for RATIONAL  |                 |   |

power relays

with DIN rail mounting

upper



|                    |   |                 |   |
|--------------------|---|-----------------|---|
| <b>GEV No.</b>     | 380610  | <b>Ref. No.</b> | 1200002018<br>12019647<br>12038273<br>Z203018 |
| <b>description</b> | power relays connection male faston DIN rail  |                 |   |
| <b>For models:</b> | ECO-1600, ECO-2300, ECO-3000, FI-1200, FI-1600, FI-2300, FI-30, FI-3000, FI-48, FI-48B, FI-48W, FI-64, FI-64B, FI-64W, FI-72, FI-900, LVC-12, LVC-15, LVC-15D, LVC-21, LVC-21B, LVC-21D, LVC-21W, LVR-10, LVR-14, LVR-14D, LVR-20, LVR-20B, LVR-20D |                 |   |



|                    |  |                 |   |
|--------------------|--|-----------------|---|
| <b>GEV No.</b>     | 380809   | <b>Ref. No.</b> | 12023706<br>12033296<br>12034668<br>6021130007<br>6021130033<br>Z203062 |
| <b>description</b> | power relays FINDER 230VAC 16A 2NO connection male faston 6.3mm bracket mounting manuf. no. 62.82.8.230.0307   |                 |   |
| <b>For models:</b> | AD-120, AD-120B, AD-120BTTDD-UK, AD-120C, AD-120CW, AD-120HY, AD-15, AD-15D, AD-20C-UK, AD-21, AD-21B, AD-21BDD, AD-21C, AD-21D, AD-21DD, AD-21W, AD-90, AD-90BA, AD-90BBT, AD-90BDD, AD-90DD, ADE-120, ADE-120B, ATM-051, ATM-051ECO, ATM-051VCH, ATM-051VCH-60Hz, ATM-081VCH, ATM-081VCH-60Hz, ATM-101, ATM-101VCH, ATM-101VCH-60Hz, CM-201, CM-202, CMP-201, CO-352-COLD, CO-352-COLD-B, CO-352-COLD-B-DD, CO-352-COLD-DD, CO-400-SOFT, CO-402-COLD, CO-402-COLD-B, CO-402-COLD-B-DD, CO-402-COLD-DD, CO-402W, CO-500, CO-500B, CO-500BDD, CO-500DD, CO-501...(Other models you can see in the webshop) |                 |   |

electric components



## with bracket mounting



1

|                    |   |                 |                      |
|--------------------|---|-----------------|----------------------|
| <b>GEV No.</b>     | 380139  | <b>Ref. No.</b> | 12031875<br>EU929115 |
| <b>description</b> | power relays FINDER 230VAC 16A 2CO connection F6.3 bracket mounting dimensions 68x38.2x35.8mm manuf. no. 62.82.8.230.0000 |                 |                      |

## with male contacts

## female contact 2.0mm



1

|                    |  |                 |                        |
|--------------------|--|-----------------|------------------------|
| <b>GEV No.</b>     | 380502   | <b>Ref. No.</b> | 12030936<br>RT30350485 |
| <b>description</b> | power relays connection 2.0 plug-in connection |                 |                        |

## plug-in/print relays



1

|                    |                   |                 |                        |
|--------------------|-------------------|-----------------|------------------------|
| <b>GEV No.</b>     | 380501            | <b>Ref. No.</b> | 12032188<br>RT30350486 |
| <b>description</b> | print relay 12VDC |                 |                        |

## Зип-Общепит

relay sockets

vsezip.ru

+7(812)987-08-81

1

|   |   |                 |                     |
|---|---|-----------------|---------------------|
| <b>GEV No.</b>  | 380136  | <b>Ref. No.</b> | 12024185<br>R743009 |
| <b>description</b>  | relay socket 11-pole connection plug-in connection round 11-pole dimensions 65x28x40mm 250V voltage AC 10A Italiana Relè manuf. no. ZVE11   |                 |                     |
| <b>For models:</b>  | GA-20, GA-20D, GA-40, GA-40D, HGV-10-11, HGV-20-11, HMM-10-11, HMM-10-11UL, HMM-10-21, HMM-10-21UL, HMM-20-11, HMM-20-11UL, HMM-20-21, HMM-20-21UL, HMM-2-10-11, HMM-40-11-USMC, HMM-6-11, HMM-6-11UL, HVG-10-11, HVG-10-11UL, HVG-10-21, HVG-10-21UL, HVG-20-11, HVG-20-21, HVG-2-10-11, HVG-2-20-21, ME9-10PLUS-BM, ME9-10PLUS-BMS, ME9-15BM-AD, ME9-15PLUS-BM, ME9-15PLUS-BMS, MFHMM-20-11, MFHVG-10-11, MFHVG-10-21, MG9-10BMAD, MG9-10BMSAD, MG9-10PLUS-BM, MG9-10PLUS-BMS, MG9-15BMAD, MG9-15BMSAD, MG9-15PLUS-BM, MG9-15PLUS-BMS |                 |                     |
| <b>accessories for</b>  | 380136  |                 |                     |
|  | <b>GEV No.</b>  | 380805          | <b>Ref. No.</b> —   |
|   | support bracket   |                 |                     |

## accessories



1

|                    |  |                 |                     |
|--------------------|--|-----------------|---------------------|
| <b>GEV No.</b>     | 691697                                     | <b>Ref. No.</b> | 12011818<br>U805615 |
| <b>description</b> | fastening angle for contactor suitable for |                 |                     |
| <b>For models:</b> | CE7-41, CGE7-217, CGE7-41                  |                 |                     |

## level relays

## miscellaneous



1

|                    |  |                 |                                 |
|--------------------|--|-----------------|---------------------------------|
| <b>GEV No.</b>     | 400880   | <b>Ref. No.</b> | 12017268<br>12024209<br>R343072 |
| <b>description</b> | level relay 50/60Hz 230/400V contacts 1CO type VyF   |                 |                                 |
| <b>For models:</b> | GA-20, GA-20D, GA-40, GA-40D, HCV-10-11, HCV-10-21, HCV-2-10-21, HCV-5-11, HCV-6-11, HGV-10-11, HGV-20-11, HMM-10-11, HMM-10-21, HMM-20-11, HMM-20-21, HMM-2-10-11, HMM-2-20-11, HMM-6-11, HVG-10-11, HVG-10-21, HVG-20-11, HVG-20-21, HVG-2-10-11, HVG-2-20-21, ME9-10PLUS-BM, ME9-10PLUS-BMS, ME9-15BM-AD, ME9-15PLUS-BM, ME9-15PLUS-BMS, MG9-10BMAD, MG9-10BMSAD, MG9-10PLUS-BM, MG9-10PLUS-BMS, MG9-15BMAD, MG9-15BMSAD, MG9-15PLUS-BM, MG9-15PLUS-BMS |                 |                                 |



Зип.Общепит  
transformers

vsezip.ru

+7(812)987-08-81

time relays

time relays



1

|   |   |                 |  |
|---|---|-----------------|--|
| <b>GEV No.</b>  | 360318  | <b>Ref. No.</b> | 12017722<br>12039922<br>R013030<br>R723061 |
| <b>description</b>  | time relay FIBER E58F47 time range 0-12min 230VAC 5A mounting measurements 45x45mm connection plug-in connection round 8-pole |                 |  |
| <b>For models:</b>  | HCG-10-11, HCG-10-21, HCG-20-11, HCG-2-10-11, HCG-6-11, HMG-10-11, HMG-10-21, HMG-20-11, HMG-2-10-11, HMG-6-11                |                 |  |
| <b>accessories for</b>  | 360318  |                 |  |
|  | <b>GEV No.</b>  | 380638          | <b>Ref. No.</b> —                          |
|   | relay socket 8-pole dimensions 51x41x23mm 250V 10A FINDER manuf. no. 90.26  |                 |  |



1

|                    |  |                 |                                   |
|--------------------|--|-----------------|-----------------------------------|
| <b>GEV No.</b>     | 360554   | <b>Ref. No.</b> | 12024079<br>Z123022<br>Z123022000 |
| <b>description</b> | time relay TELEMECANIQUE RE17RMMU time range 0.1s-100h 24-240VAC/24VDC 8A mounting measurements DIN railmm 1CO connection screw connection   |                 |                                   |
| <b>For models:</b> | ECO-160, ECO-1600, ECO-160D, ECO-160I, ECO-200, ECO-200D, ECO-200H, ECO-200HD, ECO-200HI, ECO-200I, ECO-2300, ECO-2700D, ECO-2700I, ECO-280D, ECO-280I, ECO-3000, ECO-370D, ECO-370I, ECO-4000D, ECO-4000I, ECO-460D, ECO-460I, ECO-550D, ECO-550I, ECO-6000D, ECO-6000I, FI-160, FI-1600, FI-160AR, FI-160D, FI-160I, FI-200, FI-200AR, FI-200D, FI-200H, FI-200HD, FI-200HI, FI-200I, FI-200W, FI-2300, FI-2700D, FI-2700I, FI-280D, FI-280I, FI-3000, FI-370D, FI-370I, FI-4000D, FI-4000I, FI-460D...(Other models you can see in the webshop) |                 |                                   |

open transformers

with clamp terminal



1

|                    |  |                 |                     |
|--------------------|--|-----------------|---------------------|
| <b>GEV No.</b>     | 400888   | <b>Ref. No.</b> | 12017582<br>R723044 |
| <b>description</b> | transformer primary 220VAC secondary 230VAC 150VA secondary 0.65A connection spring terminal 50/60Hz |                 |                     |
| <b>For models:</b> | HCG-20-11, HMG-20-11   |                 |                     |



1

|                    |   |                 |  |
|--------------------|---|-----------------|--|
| <b>GEV No.</b>     | 400887  | <b>Ref. No.</b> | 12024153<br>12024173<br>12033065<br>12040013<br>50GL951275<br>R503005<br>R663039 |
| <b>description</b> | transformer primary 230VAC secondary 12/24VAC 65VA connection screw 50-60Hz   |                 |  |
| <b>For models:</b> | ACE-061, ACE-101, ACE-102, ACE-201, ACE-202, ACG-061, ACG-101, ACG-102, ACG-201, ACG-202, AE-061, AE-101, AE-102, AE-201, AE-202, AG-061, AG-101, AG-102, AG-201, AG-202, APE-061, APE-101, APE-102, APE-201, APE-202, APG-061, APG-101, APG-102, APG-201, APG-202, COE-061, COE-101, COE-102, COE-201, COE-202, COG-061, COG-101, COG-102, COG-201, COG-202, HCG-10-11, HCG-10-21, HCG-20-11, HCG-20-21, HCG-2-10-11, HCG-2-20-11, HCG-6-11, HEI-10-11, HEI-10-21, HEI-20-11...(Other models you can see in the webshop) |                 |  |



1

|                    |   |                 |                        |
|--------------------|---|-----------------|------------------------|
| <b>GEV No.</b>     | 400104  | <b>Ref. No.</b> | 12028922<br>RT30370242 |
| <b>description</b> | transformer primary 230VAC secondary 24VAC 40VA secondary 1.7A connection screw 50/60Hz with fuse |                 |                        |



Зип Общепит

vsezip.ru

+7(812)987-08-81

with plug connection



|                    |  |                 |                        |
|--------------------|--|-----------------|------------------------|
| <b>GEV No.</b>     | 400101   | <b>Ref. No.</b> | 12029247<br>RT30370240 |
| <b>description</b> | transformer primary 200-260VAC secondary 4.2/14.4/11.5VAC 68.4VA |                 |                        |



|                    |   |                 |                       |
|--------------------|---|-----------------|-----------------------|
| <b>GEV No.</b>     | 401473  | <b>Ref. No.</b> | 12028264<br>RT4000592 |
| <b>description</b> | transformer 21.6VA H 70mm L 94mm W 71mm connection plug 50-60Hz type 40.00.592 moulded secondary 12VDC primary 200-250VAC |                 |                       |

toroidal core transformers

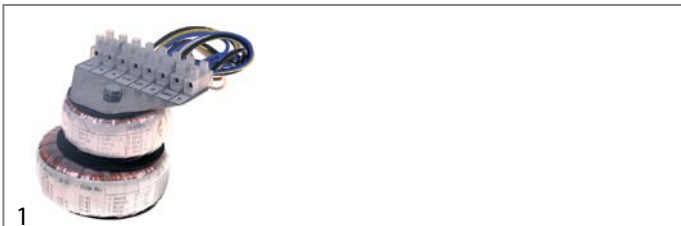

|                    |   |                 |                                |
|--------------------|---|-----------------|--------------------------------|
| <b>GEV No.</b>     | 401791  | <b>Ref. No.</b> | 12016605<br>R693060<br>R723063 |
| <b>description</b> | transformer primary 230VAC secondary 12VAC 15/50VA secondary 2.1A 50/60Hz   |                 |                                |
| <b>For models:</b> | HMG-10-11UL, HMG-10-21UL, HMI-10-11UL, HMI-10-21UL, HMI-6-11UL, HMM-10-11UL, HMM-10-21UL, HMM-20-11, HMM-20-11UL, HMM-20-21UL, HMM-40-11-USMC, HMM-6-11UL, HVG-10-11, HVG-10-11UL, HVG-10-21, HVG-10-21UL, HVG-2-10-11, MFHMM-20-11, MFHVG-10-11, MFHVG-10-21 |                 |                                |

encapsulated transformers

with plug connection



|   |   |                 |                       |
|---|---|-----------------|-----------------------|
| <b>GEV No.</b>  | 401472  | <b>Ref. No.</b> | 12028416<br>RT4000277 |
| <b>description</b>  | transformer 1/20/50VA secondary A H 70mm L 76mm W 104mm connection plug 50/60Hz type 110170 with fuse secondary 2.1/11.5/12VAC primary 230VAC |                 |                       |
| <b>spare parts for</b>  | 401472  |                 |                       |
|   | <b>GEV No.</b>  | <b>Ref. No.</b> | —                     |
|  | fine fuse size ø5x20mm 1.6A slow-acting rated 250V Qty 10 pcs   |                 |                       |

electronic controllers

CAREL

refrigeration controllers

built-in version



|                    |   |                 |            |
|--------------------|---|-----------------|------------|
| <b>GEV No.</b>     | 378527  | <b>Ref. No.</b> | 6021350106 |
| <b>description</b> | electronic controller CAREL PYC01L051G mounting measurements 71x29mm built-in depth 74mm 230V voltage AC NTC relay outputs 1 CO-12A(2) NTC NTC DI yes protection IP54 -50 up to +90°C display 3½ digits |                 |            |



|                    |  |                 |                                    |
|--------------------|--|-----------------|------------------------------------|
| <b>GEV No.</b>     | 379779   | <b>Ref. No.</b> | 12038178<br>12049777<br>6021350010 |
| <b>description</b> | electronic controller CAREL PYC01LOXXX mounting measurements 71x29mm built-in depth 74mm 230V voltage AC NTC relay outputs 3 CO-8A(4) NO-8A(4) NO-8A(4) NTC NTC DI yes 2x NTC 10K protection IP54 -50 up to +90°C display 3½ digits  |                 |                                    |
| <b>For models:</b> | AEP-802, AF-1402-MIX, AF-1403-C, AF-1403-P, AF-1404-C, AF-1404-P, AF-1602-MIX, AF-1603-C, AF-1603-P, AF-1604-C, AF-1604-P, AF-2104-C, AF-2104-P, AF-2105-C, AF-2105-P, AF-2106-C, AF-2106-P, AF-702-C, AF-702-P, AF-802-C, AF-802-P, AFN-1402, AFN-1403, AFN-1404, AFN-1602, AFN-1603, AFN-1604, AFN-701, AFN-702, AFN-801, AFN-802, AFP-702, AP-701, APP-701, MCN-135-GN, MCN-180-GN, MCN-270-GN, MFN-135, MFN-135-GN, MFN-180, MFN-180-GN, MFN-225-GN, MFN-270-GN, MPN-117-R, MPN-150, MPN-169-R, MPN-202, MPN-255, MPN-255-C, MPN-274-R...(Other models you can see in the webshop) |                 |                                    |



Зип-Общепит  
refrigeration controllers

vsezip.ru

+7(812)987-08-81

|   |  |                 |                        |
|---|--|-----------------|------------------------|
|  |  |                 |                        |
| 1   |  |                 |                        |
| <b>GEV No.</b>  | 378673   | <b>Ref. No.</b> | 12047691<br>6021350115 |
| <b>description</b>  | electronic controller CAREL PYCO1SN50P mounting measurements 71x29mm built-in depth 59mm 230V voltage AC NTC |                 |                        |

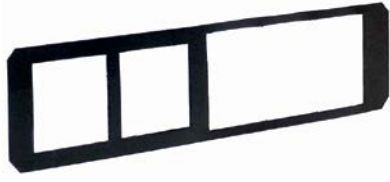
|   |  |                 |                        |
|---|--|-----------------|------------------------|
| <b>accessories</b>  |  |                 |                        |
|  |  |                 |                        |
| 1   |  |                 |                        |
| <b>GEV No.</b>  | 378669   | <b>Ref. No.</b> | 12110849<br>6003010410 |
| <b>description</b>  | frame L 162mm W 35mm H 1mm CAREL plastic black |                 |                        |

DIXELL

refrigeration controllers

built-in version

|   |   |                 |            |
|---|---|-----------------|------------|
|  |   |                 |            |
| 1   |   |                 |            |
| <b>GEV No.</b>  | 378526  | <b>Ref. No.</b> | 6021350114 |
| <b>description</b>  | electronic controller DIXELL mounting measurements 30x150mm built-in depth 42mm 230V voltage AC NTC relay outputs 3 NO-16A(8) NO-5A NO-8(3) NTC DI DI incl. probe -40 up to 110°C display 2.5 |                 |            |

ELIWELL

universal controllers

built-in version

|   |   |                 |                      |
|---|---|-----------------|----------------------|
|  |   |                 |                      |
| 1   |   |                 |                      |
| <b>GEV No.</b>  | 379622  | <b>Ref. No.</b> | 12016193<br>12017189 |
| <b>description</b>  | electronic controller ELIWELL type IC912 mounting measurements 71x29mm 12V Pt100/TC (J,K) temperature controller protection IP65 defr. funct. no 8A |                 |                      |
| <b>For models:</b>  | HGV-10-11, HGV-20-11  |                 |                      |

|  |  |                 |                                |
|--|--|-----------------|--------------------------------|
|  |  |                 |                                |
| 1  |  |                 |                                |
| <b>GEV No.</b>   | 378214   | <b>Ref. No.</b> | 12016682<br>R743003<br>T133004 |
| <b>description</b>   | electronic controller ELIWELL type EWPC902T mounting measurements 71x29mm 12V voltage AC/DC TC/J compressor relay 8A |                 |                                |

|  |  |                 |         |
|--|--|-----------------|---------|
|  |  |                 |         |
| 1  |  |                 |         |
| <b>GEV No.</b>   | 379018   | <b>Ref. No.</b> | R743005 |
| <b>description</b>   | electronic controller ELIWELL type EWPC902T thermocouple J |                 |         |

|   |   |                 |  |
|---|---|-----------------|--|
|  |   |                 |  |
| 1   |   |                 |  |
| <b>GEV No.</b>  | 379645  | <b>Ref. No.</b> | 12029316<br>12029317<br>12031127<br>12031161<br>6001507039<br>6001567002<br>6021350006<br>6021350015 |
| <b>description</b>  | electronic controller ELIWELL type ID961 mounting measurements 71x29mm 230V voltage AC NTC/PTC relay outputs 1 relay -55 up to +150°C display 3½ digits compressor relay 15A  |                 |  |
| <b>For models:</b>  | AEP-1402, AEP-1403, AEP-1404, AEP-1602, AEP-1603, AEP-1604, AEP-2103, AEP-701, AEP-702, AEP-801, AEP-802, AF-1402-MIX, AF-1403-C, AF-1403-P, AF-1404-C, AF-1404-P, AF-1602-MIX, AF-1603-C, AF-1603-P, AF-1604-C, AF-1604-P, AF-2104-C, AF-2104-P, AF-2105-C, AF-2105-P, AF-2106-C, AF-2106-P, AF-702-C, AF-702-P, AF-802-C, AF-802-P, AFP-1402, AFP-1403, AFP-1403-C, AFP-1403-P, AFP-1404, AFP-1404-C, AFP-1404-P, AFP-1404-USMC, AFP-1602, AFP-1602-2, AFP-1603, AFP-1603-2, AFP-1604, AFP-2103, AFP-2104, AFP-2104-C, AFP-2104-P, AFP-2105, AFP-2105-C...(Other models you can see in the webshop) |                 |  |
| <b>accessories for</b>  | 379645  |                 |  |
|   | <b>GEV No.</b>  | 379053          | <b>Ref. No.</b> —  |
|   | temperature probe PTC 1kOhm cable PVC probe -50 up to +150°C cable -10 up to 100°C probe ø6x30mm cable length 3m without screw connection 2-wire  |                 |  |
|   | <b>GEV No.</b>  | 379064          | <b>Ref. No.</b> —  |
|   | temperature probe PTC 1kOhm cable silicone probe -50 up to +150°C cable -50 up to +180°C probe ø6x40mm cable length 3m without screw connection 2-wire  |                 |  |

Table continues overleaf

electric components



Зип Общепит

vsezip.ru

7(812)987-08-81



1

|  |        |          |   |
|--|--------|----------|---|
| <b>accessories for</b> 379645  |        |          |   |
| GEV No.  | 379161 | Ref. No. | — |
| temperature probe NTC 10kOhm cable thermoplastic probe -40 up to +110°C cable -40 up to +110°C probe ø6x14mm cable length 3m without screw connection 2-wire |        |          |   |
| GEV No.  | 379782 | Ref. No. | — |
| temperature probe PTC 1kOhm cable thermoplastic probe -50 up to +150°C cable -40 up to +110°C probe ø6x14mm cable length 3m 2-wire resistor 1kOhm            |        |          |   |



1

|   |        |          |                        |
|---|--------|----------|------------------------|
| GEV No.   | 379571 | Ref. No. | 12028942<br>6001507002 |
| <b>description</b><br>electronic controller ELIWELL type ID961 mounting measurements 71x29mm 230V voltage AC NTC/PTC relay outputs 1 relay -55 up to +150°C display 3½ digits RoomTempIN yes compressor relay 8A  |        |          |                        |
| <b>For models:</b><br>AEP-1402, AEP-1403, AEP-1404, AEP-1602, AEP-1603, AEP-1604, AEP-701, AEP-702, AEP-801, AEP-802, AFP-1402, AFP-1402-FORZ, AFP-1403, AFP-1403-C, AFP-1403-FORZ, AFP-1403-P, AFP-1404, AFP-1404-C, AFP-1404-FORZ, AFP-1404-P, AFP-1602, AFP-1602-2, AFP-1603, AFP-1604, AFP-2103, AFP-2104, AFP-2104-C, AFP-2104-P, AFP-2105, AFP-2105-C, AFP-2105-P, AFP-2106, AFP-2106-C, AFP-2106-P, AFP-701, AFP-701-FORZ, AFP-702, AFP-702-C, AFP-702-FORZ, AFP-702-P, AFP-801, AFP-802, AFP-802-2, APP-701, FMP-117-R, FMP-150, FMP-169-R, FMP-200, FMP-222-R, FMP-250...(Other models you can see in the webshop) |        |          |                        |
| <b>accessories for</b> 379571   |        |          |                        |
| GEV No.   | 379053 | Ref. No. | —                      |
| temperature probe PTC 1kOhm cable PVC probe -50 up to +150°C cable -10 up to 100°C probe ø6x30mm cable length 3m without screw connection 2-wire  |        |          |                        |
| GEV No.   | 379064 | Ref. No. | —                      |
| temperature probe PTC 1kOhm cable silicone probe -50 up to +150°C cable -50 up to +180°C probe ø6x40mm cable length 3m without screw connection 2-wire  |        |          |                        |
| GEV No.   | 379161 | Ref. No. | —                      |
| temperature probe NTC 10kOhm cable thermoplastic probe -40 up to +110°C cable -40 up to +110°C probe ø6x14mm cable length 3m without screw connection 2-wire  |        |          |                        |
| GEV No.   | 379782 | Ref. No. | —                      |
| temperature probe PTC 1kOhm cable thermoplastic probe -50 up to +150°C cable -40 up to +110°C probe ø6x14mm cable length 3m 2-wire resistor 1kOhm   |        |          |                        |

|  |        |   |  |
|--|--------|---|--|
| GEV No.  | 379577 | Ref. No.  | 12028377<br>12028398<br>12029857<br>12029858<br>12030168<br>6001507012<br>6001507042<br>6021350002<br>6021350007<br>6021350019 |
| <b>description</b>   |        | electronic controller ELIWELL type ID974 mounting measurements 71x29mm 230V voltage AC NTC/PTC relay outputs 3 relays -50 up to +150°C display 3½ digits RoomTempIN yes DEF Probe yes DEF Relay 8A fan relay 5A compressor relay 8A   |  |
| <b>For models:</b>   |        | AF-1402-MIX, AF-1403-C, AF-1403-P, AF-1404-C, AF-1404-P, AF-1602-MIX, AF-1603-C, AF-1603-P, AF-1604-C, AF-1604-P, AF-2104-C, AF-2104-P, AF-2105-C, AF-2105-P, AF-2106-C, AF-2106-P, AF-702-C, AF-702-P, AF-802-C, AF-802-P, AFN-1402, AFN-1403, AFN-1404, AFN-1602, AFN-1603, AFN-1604, AFN-701, AFN-702, AFN-801, AFN-802, AFP-1402-MIX, AP-701, APP-701, MCN-102-GN-R, MCN-102-R, MCN-135, MCN-135-GN, MCN-147-GN-R, MCN-147-R, MCN-180, MCN-180-GN, MCN-192-GN-R, MCN-192-R, MCN-225, MCN-225-GN, MCN-237-GN-R, MCN-237-R, MCN-270, MCN-270-GN, MFN-102-GN-R...(Other models you can see in the webshop) |  |
| <b>accessories for</b> 379577  |        |   |  |
| GEV No.  | 379053 | Ref. No.  | —  |
| temperature probe PTC 1kOhm cable PVC probe -50 up to +150°C cable -10 up to 100°C probe ø6x30mm cable length 3m without screw connection 2-wire             |        |   |  |
| GEV No.  | 379064 | Ref. No.  | —  |
| temperature probe PTC 1kOhm cable silicone probe -50 up to +150°C cable -50 up to +180°C probe ø6x40mm cable length 3m without screw connection 2-wire       |        |   |  |
| GEV No.  | 379161 | Ref. No.  | —  |
| temperature probe NTC 10kOhm cable thermoplastic probe -40 up to +110°C cable -40 up to +110°C probe ø6x14mm cable length 3m without screw connection 2-wire |        |   |  |
| GEV No.  | 379782 | Ref. No.  | —  |
| temperature probe PTC 1kOhm cable thermoplastic probe -50 up to +150°C cable -40 up to +110°C probe ø6x14mm cable length 3m 2-wire resistor 1kOhm            |        |   |  |



EVCO - EVERY CONTROL

universal controllers

built-in version



|                        |  |                 |                   |
|------------------------|--|-----------------|-------------------|
| <b>GEV No.</b>         | 378131   | <b>Ref. No.</b> | 12017197          |
| <b>description</b>     | electronic controller EVERY CONTROL EVK411M mounting measurements 71x29mm 12V voltage AC/DC NTC/PTC/Pt100/Pt1000 relay outputs 1 CO-16A(8) NTC/PTC/Pt100/Pt1000(TC(J,K))/mV/mA yes protection IP65 depend on probe°C display 3½ digits |                 |                   |
| <b>accessories for</b> | 378131   |                 |                   |
|                        | <b>GEV No.</b>   | 379050          | <b>Ref. No.</b> — |
|                        | temperature probe Pt100 cable Vetrotex probe -200 up to +600°C cable -50 up to +350°C probe ø6x100mm cable length 2.7m without screw connection 3-wire   |                 |                   |
|                        | <b>GEV No.</b>   | 379160          | <b>Ref. No.</b> — |
|                        | temperature probe NTC 10kOhm cable thermoplastic probe -40 up to +110°C cable -40 up to +110°C probe ø6x14mm cable length 1.5m without screw connection 2-wire   |                 |                   |
|                        | <b>GEV No.</b>   | 379781          | <b>Ref. No.</b> — |
|                        | temperature probe PTC 1kOhm cable thermoplastic probe -50 up to +150°C cable -40 up to +110°C probe ø6x14mm cable length 1.5m without screw connection 2-wire  |                 |                   |
|                        | <b>GEV No.</b>   | 379944          | <b>Ref. No.</b> — |
|                        | temperature probe Pt1000 cable Vetrotex probe -70 up to +500°C cable -50 up to +350°C connection 2-wire thread probe ø6x180mm cable length 1.7m  |                 |                   |

probes

universal probes

temperature probes



|                    |   |                 |                        |
|--------------------|---|-----------------|------------------------|
| <b>GEV No.</b>     | 379343  | <b>Ref. No.</b> | 12040436<br>6021350013 |
| <b>description</b> | temperature probe NTC 10kOhm cable silicone probe -40 up to +110°C cable -50 up to +180°C probe ø6x40mm cable length 3m 2-wire  |                 |                        |
| <b>For models:</b> | AEP-1402, AEP-1602, AEP-2103, AEP-701, AEP-801, AEP-802, AF-1402-MIX, AF-1403-C, AF-1403-P, AF-1404-C, AF-1404-P, AF-1602-MIX, AF-1603-C, AF-1603-P, AF-1604-C, AF-1604-P, AF-2104-C, AF-2104-P, AF-2105-C, AF-2105-P, AF-2106-C, AF-2106-P, AF-702-C, AF-702-P, AF-802-C, AF-802-P, AFN-1402, AFN-1403, AFN-1404, AFN-1602, AFN-1603, AFN-1604, AFN-702, AFN-801, AFN-802, AFP-1402, AFP-1403, AFP-1404, AFP-1404-USMC, AFP-1602, AFP-1602-2, AFP-1603, AFP-1603-2, AFP-1604, AFP-2103, AFP-2104, AFP-2105, AFP-2106, AFP-701, AFP-702...(Other models you can see in the webshop) |                 |                        |



|                    |  |                 |            |
|--------------------|--|-----------------|------------|
| <b>GEV No.</b>     | 379630   | <b>Ref. No.</b> | 6021350083 |
| <b>description</b> | temperature probe NTC 10kOhm cable thermoplastic probe -40 up to +110°C cable -40 up to +110°C probe ø6x14mm cable length 2.5m without screw connection 2-wire resistor 10kOhm |                 |            |

Зип Общепит

vsezip.ru

+7(812)987 08 81



|                    |   |                 |                       |
|--------------------|---|-----------------|-----------------------|
| <b>GEV No.</b>     | 379478  | <b>Ref. No.</b> | 12038239<br>602000057 |
| <b>description</b> | temperature probe NTC 10kOhm cable thermoplastic probe -40 up to +110°C cable -40 up to +110°C probe ø6x40mm cable length 3m cable colours white/red 2-wire |                 |                       |



|                    |   |                 |                        |
|--------------------|---|-----------------|------------------------|
| <b>GEV No.</b>     | 379142  | <b>Ref. No.</b> | 12033839<br>6021350026 |
| <b>description</b> | temperature probe PTC 1kOhm cable PVC probe -50 up to +150°C cable -10 up to 100°C probe ø6x30mm cable length 1.5m without screw connection 2-wire  |                 |                        |
| <b>For models:</b> | ATM-101, VTP-139-C, VTP-139-CD, VTP-139-P, VTP-139-PD, VTP-139-RC, VTP-139-RCD, VTP-139-RP, VTP-139-RPD, VTP-175-C, VTP-175-CD, VTP-175-P, VTP-175-PD, VTP-175-RC, VTP-175-RCD, VTP-175-RP, VTP-175-RPD |                 |                        |



|                    |  |                 |                      |
|--------------------|--|-----------------|----------------------|
| <b>GEV No.</b>     | 379487   | <b>Ref. No.</b> | 12032993<br>FR995562 |
| <b>description</b> | temperature probe PTC cable silicone probe -50 up to +150°C cable -50 up to +180°C probe ø6x30mm cable length 2.5m without screw connection 2-wire |                 |                      |



|                    |  |                 |                     |
|--------------------|--|-----------------|---------------------|
| <b>GEV No.</b>     | 379553   | <b>Ref. No.</b> | 12017340<br>T113088 |
| <b>description</b> | core temperature probe thermocouple K (NiCr-Ni) cable PTFE probe -40 up to +250°C cable -40 up to +250°C probe ø4x120mm cable length 2m thread handle ø 10mm handle length 60mm 2-wire |                 |                     |
| <b>For models:</b> | HGV-10-11, HGV-20-11   |                 |                     |

core probes



|                    |   |                 |                                |
|--------------------|---|-----------------|--------------------------------|
| <b>GEV No.</b>     | 379529  | <b>Ref. No.</b> | 12017395<br>R673059<br>R673076 |
| <b>description</b> | temperature probe thermocouple J (Fe-CuNi) cable PTFE probe -50 up to +750°C cable -40 up to +250°C probe ø4x120mm cable length 1.9m 2-wire   |                 |                                |
| <b>For models:</b> | HEM-10-11, HEM-20-11, HEM-6-11, HEP-10-11, HEP-20-11, HEP-6-11, HME-10-11, HME-10-21, HME-2-10-11, HMM-10-11, HMM-10-11UL, HMM-10-21, HMM-10-21UL, HMM-2-10-11, HMP-10-11, HMP-10-21, HMP-2-10-11 |                 |                                |

|                        |  |        |                 |                     |
|------------------------|--|--------|-----------------|---------------------|
| <b>accessories for</b> | 379529   |        |                 |                     |
|                        | <b>GEV No.</b>   | 691097 | <b>Ref. No.</b> | 12024241<br>T133037 |
|                        | holding plate for probe mounting pos. upper L 35mm W 12mm H 4mm SS |        |                 |                     |
|                        | <b>GEV No.</b>   | 691098 | <b>Ref. No.</b> | 12024243<br>T133036 |
|                        | holding plate for probe mounting pos. lower L 35mm W 12mm H 4mm SS |        |                 |                     |

electric components



producer-specific probes

Зип Общепит

probes



|                    |  |                 |                     |
|--------------------|--|-----------------|---------------------|
| <b>GEV No.</b>     | 379489   | <b>Ref. No.</b> | 12024649<br>T303007 |
| <b>description</b> | core temperature probe thermocouple J (Fe-CuNi) cable PTFE probe -50 up to +750°C cable -40 up to +250°C connection male faston thread probe ø4x120mm cable length 1.85m |                 |                     |
| <b>For models:</b> | HEM-10-21, HEM-20-21, HGV-10-21, HGV-20-21, VE-102, VE-202, VG-102, VG-202   |                 |                     |



|                    |  |                 |                       |
|--------------------|--|-----------------|-----------------------|
| <b>GEV No.</b>     | 379430   | <b>Ref. No.</b> | 12040499<br>RT4001095 |
| <b>description</b> | core temperature probe thermocouple K (NiCr-Ni) cable silicone probe -50 up to +1150°C cable -50 up to +180°C connection coded plug thread probe ø1.5x140mm cable length 1.65m |                 |                       |

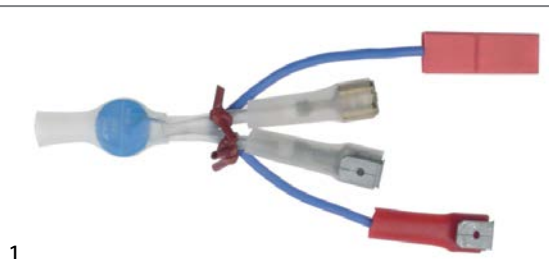

|                    |  |                 |                     |
|--------------------|--|-----------------|---------------------|
| <b>GEV No.</b>     | 379554   | <b>Ref. No.</b> | 12020413<br>R073008 |
| <b>description</b> | probe PTC cable silicone probe -50 up to +150°C cable -50 up to +180°C connection plug-in connection thread probe ø4x13mm cable length 0.05m   |                 |                     |
| <b>For models:</b> | HCG-10-11, HCG-10-21, HCG-20-11, HCG-20-21, HCG-2-10-11, HCG-2-20-11, HCG-6-11, HG-10-21, HG-2-10-11, HMG-10-11, HMG-10-11UL, HMG-10-21, HMG-10-21UL, HMG-20-11, HMG-2-10-11, HMG-6-11, HVG-10-11, HVG-10-11UL, HVG-10-21, HVG-10-21UL, HVG-20-11, HVG-20-21, HVG-2-10-11, HVG-2-20-21, MFHVG-10-11, MFHVG-10-21 |                 |                     |



|                    |  |                 |                        |
|--------------------|--|-----------------|------------------------|
| <b>GEV No.</b>     | 381544   | <b>Ref. No.</b> | 12039678<br>T953051000 |
| <b>description</b> | temperature probe connection plug probe 4x540mm cable length 2m      |                 |                        |
| <b>For models:</b> | ACE-202, ACG-202, AE-202, AG-202, APE-102, APE-202, APG-102, APG-202 |                 |                        |



|                    |  |                 |          |
|--------------------|--|-----------------|----------|
| <b>GEV No.</b>     | 403925   | <b>Ref. No.</b> | 12041634 |
| <b>description</b> | temperature probe connection plug probe ø4x362 cable length 2m   |                 |          |
| <b>For models:</b> | ACE-061, ACE-101, ACE-102, ACE-201, ACG-061, ACG-101, ACG-102, ACG-201, AE-061, AE-101, AE-102, AE-201, AG-061, AG-101, AG-102, AG-201 |                 |          |



|                    |  |                 |          |
|--------------------|--|-----------------|----------|
| <b>GEV No.</b>     | 403924   | <b>Ref. No.</b> | 12044609 |
| <b>description</b> | temperature probe connection plug probe ø4x425mm cable length 2m |                 |          |
| <b>For models:</b> | APE-061, APE-101, APE-201, APG-061, APG-101, APG-201             |                 |          |



|                    |  |                 |          |
|--------------------|--|-----------------|----------|
| <b>GEV No.</b>     | 403929   | <b>Ref. No.</b> | 12047675 |
| <b>description</b> | temperature probe connection plug probe ø4x627 cable length 2m |                 |          |
| <b>For models:</b> | ACE-202, ACG-202, AE-202, AG-202                               |                 |          |



|                    |  |                 |                     |
|--------------------|--|-----------------|---------------------|
| <b>GEV No.</b>     | 379550   | <b>Ref. No.</b> | 12019258<br>Z233007 |
| <b>description</b> | temperature probe NTC 10kOhm cable silicone probe -40 up to +110°C cable -50 up to +180°C connection male faston thread probe ø6x30mm cable length 0.35m |                 |                     |
| <b>For models:</b> | FI-50  |                 |                     |



|                    |  |                 |                     |
|--------------------|--|-----------------|---------------------|
| <b>GEV No.</b>     | 378339   | <b>Ref. No.</b> | 12025036<br>Z713028 |
| <b>description</b> | temperature probe NTC 64kOhm cable silicone probe -40 up to +110°C cable -50 up to +180°C connection plug thread probe ø6x14mm cable length 2.5m   |                 |                     |
| <b>For models:</b> | AD-120, AD-120B, AD-120BBTDD-UK, AD-120C, AD-120CW, AD-120HY, AD-125, AD-125HRS, AD-125-SOFT, AD-15, AD-15D, AD-20C-UK, AD-21, AD-21B, AD-21BDD, AD-21C, AD-21D, AD-21DD, AD-21W, AD-45BBT, AD-48, AD-48B, AD-48BDD, AD-48C, AD-48D, AD-48DD, AD-48HY, AD-48W, AD-505, AD-505-SOFT, AD-64, AD-64B, AD-64BBT, AD-64BDD, AD-64BTDD, AD-64C, AD-64CW, AD-64D, AD-64DD, AD-64HY, AD-72, AD-72W, AD-90, AD-90BA, AD-90BBT, AD-90BDD, AD-90DD, ADE-120, ADE-120B, CO-112...(Other models you can see in the webshop) |                 |                     |



|                    |  |                 |          |
|--------------------|--|-----------------|----------|
| <b>GEV No.</b>     | 402005   | <b>Ref. No.</b> | 62040410 |
| <b>description</b> | temperature probe PTC 2kOhm cable TPE probe -50 up to +150°C cable -40 up to +110°C connection plug thread probe ø6x50mm cable length 1.6m |                 |          |



|                    |   |                 |                     |
|--------------------|---|-----------------|---------------------|
| <b>GEV No.</b>     | 400874  | <b>Ref. No.</b> | 12018718<br>R663090 |
| <b>description</b> | temperature probe thermocouple J (Fe-CuNi) cable PTFE probe -50 up to +750°C cable -40 up to +250°C connection male faston thread probe ø3x70mm cable length 1.5m   |                 |                     |
| <b>For models:</b> | HCG-10-11, HCG-10-21, HCG-20-11, HCG-20-21, HCG-2-10-11, HCG-2-20-11, HCG-6-11, HEI-10-11, HEI-20-11, HEI-6-11, HEM-10-11, HEM-20-11, HEM-6-11, HEP-10-11, HEP-20-11, HEP-6-11, HGC-10-11, HGC-20-11, HGC-6-11, HME-10-11, HME-10-21, HME-20-11, HME-20-21, HME-2-10-11, HME-2-20-11, HME-6-11, HMG-20-11, HMI-10-11, HMI-10-11UL, HMI-10-21, HMI-10-21UL, HMI-2-10-11, HMI-6-11, HMI-6-11UL, HMM-10-11, HMM-10-11UL, HMM-10-21, HMM-10-21UL, HMM-20-11, HMM-20-11UL, HMM-20-21, HMM-20-21UL, HMM-2-10-11, HMM-40-11-USMC, HMM-6-11, HMM-6-11UL, HMP-10-11, HMP-10-21, HMP-20-11, HMP-20-21...(Other models you can see in the webshop) |                 |                     |

electric components



Зип Общепит

vsezip.ru

77(812)987-08-81



|                    |   |                 |                     |
|--------------------|---|-----------------|---------------------|
| <b>GEV No.</b>     | 400873  | <b>Ref. No.</b> | 12018312<br>R663089 |
| <b>description</b> | temperature probe thermocouple J (Fe-CuNi) cable PTFE probe -50 up to 1150°C cable -40 up to +250°C connection 2-wire thread probe ø3x70mm cable length 2.5m  |                 |                     |
| <b>For models:</b> | HEM-10-11, HEM-20-11, HEM-6-11, HEP-10-11, HEP-20-11, HEP-6-11, HGV-10-11, HGV-20-11, HME-10-11, HME-10-21, HME-20-11, HME-20-21, HME-2-10-11, HME-2-20-11, HME-6-11, HMP-10-11, HMP-10-21, HMP-20-11, HMP-20-21, HMP-2-10-11, HMP-6-11 |                 |                     |



|                    |  |                 |          |
|--------------------|--|-----------------|----------|
| <b>GEV No.</b>     | 381430   | <b>Ref. No.</b> | 12031446 |
| <b>description</b> | temperature probe thermocouple K (NiCr-Ni) cable silicone probe -50 up to 1150°C cable -50 up to +180°C connection 2-wire thread probe ø2x100mm cable length 0.25m |                 |          |



|                    |   |                 |                     |
|--------------------|---|-----------------|---------------------|
| <b>GEV No.</b>     | 379525  | <b>Ref. No.</b> | 12024642<br>T323011 |
| <b>description</b> | temperature probe thermocouple K (NiCr-Ni) cable PTFE probe -50 up to 1150°C cable -40 up to +250°C connection male faston 6.3mm thread probe ø3x70mm cable length 1m   |                 |                     |
| <b>For models:</b> | ACE-061, ACE-101, ACE-102, ACE-201, ACE-202, ACG-061, ACG-101, ACG-102, ACG-201, ACG-202, AE-061, AE-101, AE-102, AE-201, AE-202, AG-061, AG-101, AG-102, AG-201, AG-202, APE-061, APE-101, APE-102, APE-201, APE-202, APG-061, APG-101, APG-102, APG-201, APG-202, COE-061, COE-101, COE-102, COE-201, COE-202, COG-061, COG-101, COG-102, COG-201, COG-202, HEI-10-21, HEI-20-21, HEM-10-21, HEM-20-21, HEP-10-21, HEP-20-21, HGC-10-21, HGC-20-21, HGP-10-21, HGP-20-21, HGV-10-21...(Other models you can see in the webshop) |                 |                     |



|                    |   |                 |                        |
|--------------------|---|-----------------|------------------------|
| <b>GEV No.</b>     | 381433  | <b>Ref. No.</b> | 12038044<br>RT30141004 |
| <b>description</b> | temperature probe thermocouple K (NiCr-Ni) cable silicone probe -50 up to 1150°C cable -50 up to +180°C connection 2-wire thread probe ø2x100mm cable length 2.2m |                 |                        |



|                    |   |                 |                        |
|--------------------|---|-----------------|------------------------|
| <b>GEV No.</b>     | 381424  | <b>Ref. No.</b> | 12029772<br>RT87201003 |
| <b>description</b> | temperature probe thermocouple K (NiCr-Ni) cable silicone probe -50 up to 1150°C cable -50 up to +180°C connection 2-wire thread probe ø2x100mm cable length 2m |                 |                        |





|                    |   |                 |                     |
|--------------------|---|-----------------|---------------------|
| <b>GEV No.</b>     | 379528  | <b>Ref. No.</b> | 12023901<br>T323024 |
| <b>description</b> | temperature probe thermocouple K (NiCr-Ni) cable PTFE probe -50 up to 1150°C cable -40 up to +250°C connection male faston thread probe ø3x70mm cable length 1.6m   |                 |                     |
| <b>For models:</b> | ACE-061, ACE-102, AE-061, AE-101, AE-102, AE-201, AE-202, AG-061, AG-101, AG-102, AG-201, AG-202, APE-061, APE-101, APE-102, APE-201, APE-202, APG-061, APG-101, APG-102, APG-201, APG-202, COE-061, COE-101, COE-102, COE-201, COE-202, HEI-10-21, HEI-20-21, HEM-10-21, HEM-20-21, HEP-10-21, HEP-20-21, HGP-10-21, HGP-20-21, HGV-10-21, HGV-20-21, VE-061, VE-101, VE-102, VE-201, VE-202, VG-101, VG-102, VG-201, VG-202, VPE-061, VPE-101, VPE-102, VPE-201...(Other models you can see in the webshop) |                 |                     |



|                    |  |                 |                        |
|--------------------|--|-----------------|------------------------|
| <b>GEV No.</b>     | 379077   | <b>Ref. No.</b> | 12029895<br>RT87201002 |
| <b>description</b> | temperature probe thermocouple K (NiCr-Ni) cable silicone probe -50 up to 1150°C cable -50 up to +180°C connection 2-wire thread probe ø2x40mm cable length 2.6m |                 |                        |

**accessories for** 379077

|   |                |        |                 |                        |
|---|----------------|--------|-----------------|------------------------|
|  | <b>GEV No.</b> | 550365 | <b>Ref. No.</b> | 12037350<br>RT30140162 |
| gasket for thermocouple   |                |        |                 |                        |
|  | <b>GEV No.</b> | 550366 | <b>Ref. No.</b> | 12037422<br>RT30140163 |
| screw for thermocouple  |                |        |                 |                        |



|                    |   |                 |                        |
|--------------------|---|-----------------|------------------------|
| <b>GEV No.</b>     | 381431  | <b>Ref. No.</b> | 12031553<br>RT30140165 |
| <b>description</b> | temperature probe thermocouple K (NiCr-Ni) cable silicone probe -50 up to 1150°C cable -50 up to +180°C connection 2-wire thread probe ø1.5x100mm cable length 1.8m |                 |                        |



|                    |  |                 |                        |
|--------------------|--|-----------------|------------------------|
| <b>GEV No.</b>     | 379429   | <b>Ref. No.</b> | 12030579<br>RT30141020 |
| <b>description</b> | temperature probe thermocouple K (NiCr-Ni) cable silicone probe -50 up to 1150°C cable -50 up to +180°C connection 2-wire thread probe ø10.5mm cable length 1.7m |                 |                        |



|                    |   |                 |                       |
|--------------------|---|-----------------|-----------------------|
| <b>GEV No.</b>     | 379864  | <b>Ref. No.</b> | 12029713<br>RT4000594 |
| <b>description</b> | temperature probe thermocouple K (NiCr-Ni) cable silicone probe -50 up to 1150°C cable -50 up to +180°C connection coded plug thread M8 probe ø2x50mm cable length 1.2m |                 |                       |



Зип Общепит

vsezip.ru

+7(812)987-08-81



|                    |   |                 |                       |
|--------------------|---|-----------------|-----------------------|
| <b>GEV No.</b>     | 379873  | <b>Ref. No.</b> | 12031261<br>RT4000292 |
| <b>description</b> | temperature probe thermocouple K (NiCr-Ni) cable silicone probe -50 up to 1150°C cable -50 up to +180°C connection coded plug thread probe ø1.5x180mm cable length 1.6m |                 |                       |



|                    |   |                 |                       |
|--------------------|---|-----------------|-----------------------|
| <b>GEV No.</b>     | 379441  | <b>Ref. No.</b> | 12031482<br>RT4000291 |
| <b>description</b> | temperature probe thermocouple K (NiCr-Ni) cable silicone probe -50 up to 1150°C cable -50 up to +180°C connection coded plug thread probe ø2x125mm cable length 1.5m |                 |                       |

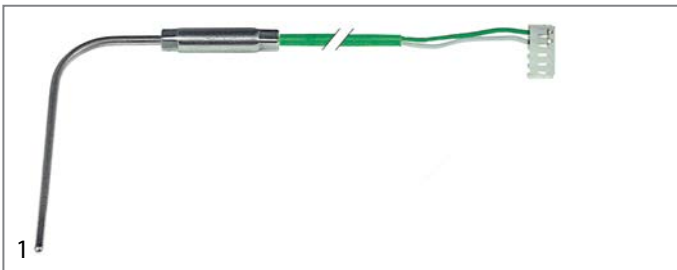

|                    |  |                 |   |
|--------------------|--|-----------------|---|
| <b>GEV No.</b>     | 379869   | <b>Ref. No.</b> | 12029187<br>12029188<br>12036625<br>RT4000287<br>RT4000398<br>RT8700058 |
| <b>description</b> | temperature probe thermocouple K (NiCr-Ni) cable silicone probe -50 up to 1150°C cable -50 up to +180°C connection coded plug thread probe ø2x70mm cable length 2.5m |                 |   |



|                    |  |                 |                       |
|--------------------|--|-----------------|-----------------------|
| <b>GEV No.</b>     | 379442   | <b>Ref. No.</b> | 12040500<br>RT4001094 |
| <b>description</b> | temperature probe thermocouple K (NiCr-Ni) cable silicone probe -50 up to 1150°C cable -50 up to +180°C connection coded plug thread probe ø2x90mm cable length 1.5m |                 |                       |



|                    |   |                 |                       |
|--------------------|---|-----------------|-----------------------|
| <b>GEV No.</b>     | 379870  | <b>Ref. No.</b> | 12033003<br>RT4000399 |
| <b>description</b> | temperature probe thermocouple K (NiCr-Ni) cable silicone probe -50 up to 1150°C cable -50 up to +180°C connection coded plug thread probe ø4.2mm cable length 1.7m |                 |                       |

**core probes**



|                    |   |                 |                        |
|--------------------|---|-----------------|------------------------|
| <b>GEV No.</b>     | 379867  | <b>Ref. No.</b> | 12026815<br>RT4000298P |
| <b>description</b> | conversion kit thermocouple K (NiCr-Ni) cable PTFE probe -40 up to +250°C cable -40 up to +250°C connection plug probe ø3x100mm thread M16 cable length 2.2m handle ø 10mm handle length 40mm |                 |                        |

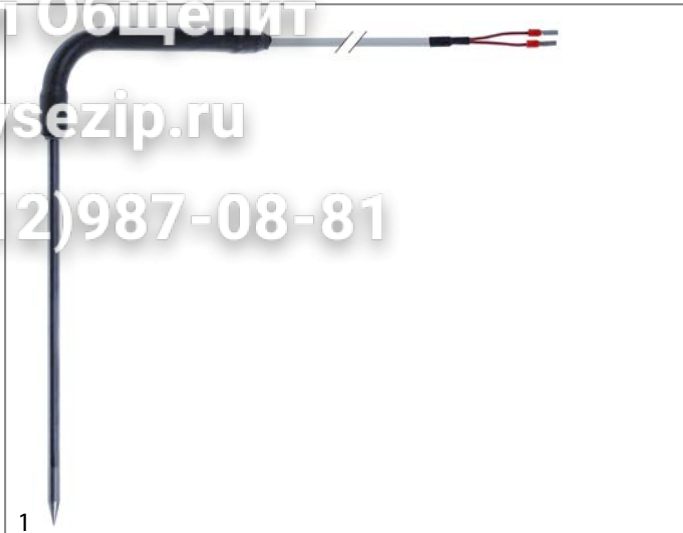

|                    |   |                 |                        |
|--------------------|---|-----------------|------------------------|
| <b>GEV No.</b>     | 379167  | <b>Ref. No.</b> | 12028770<br>6021350027 |
| <b>description</b> | core temperature probe PTC cable silicone probe -50 up to +150°C cable -50 up to +180°C connection 2-wire probe ø6x180mm thread cable length 3.1m handle ø 12mm handle length 120/40mm L1 130mm L2 50mm |                 |                        |
| <b>For models:</b> | ATM-051, ATM-101, ATM-102   |                 |                        |



|                    |   |                 |                                 |
|--------------------|---|-----------------|---------------------------------|
| <b>GEV No.</b>     | 400875  | <b>Ref. No.</b> | 12039138<br>12040015<br>R663015 |
| <b>description</b> | core temperature probe thermocouple J (Fe-CuNi) cable SS corrugated hose probe -40 up to +250°C cable -40 up to +250°C connection 2-wire probe ø3x90mm thread cable length 1.5m handle ø 8mm handle length 60mm |                 |                                 |
| <b>For models:</b> | HME-6-11, HMG-6-11, HMM-10-11, HMM-10-21, HMM-2-10-11, HMM-6-11, HMM-6-11UL, HMP-6-11   |                 |                                 |



|                    |  |                 |         |
|--------------------|--|-----------------|---------|
| <b>GEV No.</b>     | 400876   | <b>Ref. No.</b> | R673001 |
| <b>description</b> | core temperature probe thermocouple J (Fe-CuNi) cable SS corrugated hose probe -40 up to +250°C cable -40 up to +250°C connection 2-wire probe ø3x90mm thread cable length 1.65m handle ø 8mm handle length 60mm |                 |         |



|                    |   |                 |                                |
|--------------------|---|-----------------|--------------------------------|
| <b>GEV No.</b>     | 400877  | <b>Ref. No.</b> | 12000187<br>R093000<br>R093019 |
| <b>description</b> | core temperature probe thermocouple J (Fe-CuNi) cable SS corrugated hose probe -40 up to +250°C cable -40 up to +250°C connection 2-wire probe ø3x90mm thread cable length 2.2m handle ø 8mm handle length 60mm |                 |                                |
| <b>For models:</b> | HME-20-11, HME-20-21, HME-2-20-11, HMG-20-11, HMM-20-11, HMM-20-11UL, HMM-20-21, HMM-20-21UL, HMP-20-11, HMP-20-21, MFHMM-20-11   |                 |                                |





Зип Общепит  
vsezip.ru  
+7(812)987-08-81

|   |  |                 |                        |
|---|--|-----------------|------------------------|
|  |  |                 |                        |
| <b>GEV No.</b>  | 381426   | <b>Ref. No.</b> | 12027356<br>RT30350709 |
| <b>description</b>  | core temperature probe thermocouple K (NiCr-Ni) cable PTFE probe -40 up to +250°C cable -40 up to +250°C connection 2-wire probe ø3.2x100mm thread M12 cable length 1.9m handle ø 10mm handle length 100mm |                 |                        |

|   |  |                 |                        |
|---|--|-----------------|------------------------|
|  |  |                 |                        |
| <b>GEV No.</b>  | 378670   | <b>Ref. No.</b> | 12039548<br>T843062000 |
| <b>description</b>  | core temperature probe thermocouple K (NiCr-Ni) cable PTFE probe -40 up to +250°C cable -40 up to +250°C connection 5-wire probe ø4x100mm thread 1/4" cable length 2m handle ømm handle length 55mm multipoint probe |                 |                        |

|                    |  |  |  |
|--------------------|--|--|--|
| <b>For models:</b> | ACE-061, ACE-101, ACE-102, ACE-201, ACE-202, ACG-061, ACG-101, ACG-102, ACG-201, ACG-202, AE-061, AE-061W, AE-101, AE-101W, AE-102, AE-102W, AE-201, AE-202, AG-061, AG-061W, AG-101, AG-101W, AG-102, AG-102W, AG-201, AG-202, APE-061, APE-061W, APE-101, APE-101W, APE-102, APE-102W, APE-201, APE-202, APG-061, APG-061W, APG-101, APG-101W, APG-102, APG-102W, APG-201, APG-202 |  |  |
|--------------------|--|--|--|

|   |  |                 |                        |                     |
|---|--|-----------------|------------------------|---------------------|
|  |  |                 |                        |                     |
| <b>GEV No.</b>  | 379792 <sup>1</sup>  | <b>Ref. No.</b> | 12026252<br>RT30350717 |                     |
| <b>description</b>  | core temperature probe thermocouple K (NiCr-Ni) cable PTFE probe -40 up to +250°C cable -40 up to +250°C connection grip connection probe ø3.2x100mm thread M16x2 cable length 1.9m handle ø 10mm handle length 40mm |                 |                        |                     |
| <b>accessories for</b>  | 379792   |                 |                        |                     |
|  | <b>GEV No.</b>   | 510179          | <b>Ref. No.</b>        | 12010145<br>Q306012 |
|   | flat gasket fibre ED ø 18mm ID ø 13mm thickness 1.5mm Qty 1 pcs  |                 |                        |                     |
|  | <b>GEV No.</b>   | 560519          | <b>Ref. No.</b>        | —                   |
|   | nut thread M12x1 H 5mm WS 17 SS Qty 1 pcs  |                 |                        |                     |

<sup>1</sup>multipoint probe

|   |   |                 |  |
|---|---|-----------------|--|
|  |   |                 |  |
| <b>GEV No.</b>  | 379868 <sup>1</sup>   | <b>Ref. No.</b> | 12026495<br>12103868<br>RT4000295<br>RT8700096 |
| <b>description</b>  | core temperature probe thermocouple K (NiCr-Ni) cable PTFE probe -40 up to +250°C cable -40 up to +250°C connection plug probe ø3x100mm thread M16 cable length 2.2m handle ø 10mm handle length 40mm |                 |  |

<sup>1</sup>multipoint probe

|  |  |                 |   |
|--|--|-----------------|---|
|  |  |                 |   |
| <b>GEV No.</b>   | 379866 <sup>1</sup>  | <b>Ref. No.</b> | 12026609<br>12027340<br>RT4000606<br>RT4000606P |
| <b>description</b>   | core temperature probe thermocouple K (NiCr-Ni) cable PTFE probe -40 up to +250°C cable -40 up to +250°C connection plug probe ø3x100mm thread M16 cable length 2.3m handle ømm handle length 50mm |                 |   |



<sup>1</sup>multipoint probe

|  |  |                 |                     |
|--|--|-----------------|---------------------|
|  |  |                 |                     |
| <b>GEV No.</b>   | 379552   | <b>Ref. No.</b> | 12039150<br>T113007 |
| <b>description</b>   | core temperature probe thermocouple K (NiCr-Ni) cable Vetrotex probe -40 up to +250°C cable -50 up to +350°C connection 2-wire probe ø3x90mm thread cable length 1.65m handle ø 8mm handle length 50mm |                 |                     |
| <b>For models:</b>   | HVG-10-11, HVG-10-11UL, HVG-10-21, HVG-10-21UL, HVG-2-10-11, MFHVG-10-11, MFHVG-10-21  |                 |                     |

accessories

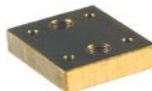
fasteners

|   |  |                 |                     |
|---|--|-----------------|---------------------|
|  |  |                 |                     |
| <b>GEV No.</b>  | 691084   | <b>Ref. No.</b> | 12023773<br>R662659 |
| <b>description</b>  | duct for probe   |                 |                     |
| <b>For models:</b>  | COE-061, COE-101, COG-061, COG-101, HCG-10-11, HCG-10-21, HCG-20-11, HCG-20-21, HCG-2-10-11, HCG-2-20-11, HCG-6-11, HEI-10-11, HEI-20-11, HEI-6-11, HEM-10-11, HEM-20-11, HEM-6-11, HEP-10-11, HEP-20-11, HEP-6-11, HGC-10-11, HGC-20-11, HGC-6-11, HGV-10-11, HGV-20-11, HME-10-11, HME-10-21, HME-20-11, HME-20-21, HME-2-10-11, HME-2-20-11, HME-6-11, HMG-10-11, HMG-10-11UL, HMG-10-21, HMG-10-21UL, HMG-20-11, HMG-2-10-11, HMG-6-11, HMI-10-11, HMI-10-11UL, HMI-10-21, HMI-10-21UL, HMI-2-10-11, HMI-6-11, HMI-6-11UL, HMM-10-11, HMM-10-11UL, HMM-10-21, HMM-10-21UL... (Other models you can see in the webshop) |                 |                     |

|   |   |                 |                     |                     |
|---|---|-----------------|---------------------|---------------------|
|  |   |                 |                     |                     |
| <b>GEV No.</b>  | 691098  | <b>Ref. No.</b> | 12024243<br>T133036 |                     |
| <b>description</b>  | holding plate for probe mounting pos. lower L 35mm W 12mm H 4mm SS  |                 |                     |                     |
| <b>For models:</b>  | HEM-10-11, HEM-20-11, HEM-6-11, HEP-10-11, HEP-20-11, HEP-6-11, HGV-10-11, HGV-20-11, VE-061, VE-101, VE-201, VPE-061, VPE-101, VPE-201 |                 |                     |                     |
| <b>accessories for</b>  | 691098  |                 |                     |                     |
|  | <b>GEV No.</b>  | 691097          | <b>Ref. No.</b>     | 12024241<br>T133037 |
|   | holding plate for probe mounting pos. upper L 35mm W 12mm H 4mm SS  |                 |                     |                     |





Зип.Общепит

maecchaneos



vsezip.ru

+7(812)987 08 81

|  |   |                 |                     |
|--|---|-----------------|---------------------|
|  |   |                 |                     |
| <b>GEV No.</b>   | 691097  | <b>Ref. No.</b> | 12024241<br>T133037 |
| <b>description</b>   | holding plate for probe mounting pos. upper L 35mm W 12mm H 4mm SS  |                 |                     |
| <b>For models:</b>   | COE-061, COE-101, HEM-10-11, HEM-20-11, HEM-6-11, HEP-10-11, HEP-20-11, HEP-6-11, HGV-10-11, HGV-20-11, VE-061, VE-101, VE-201, VPE-061, VPE-101, VPE-201 |                 |                     |
| <b>accessories for</b>   | 691097  |                 |                     |
|  |   |                 |                     |
| <b>GEV No.</b>   | 691098  | <b>Ref. No.</b> | 12024243<br>T133036 |
| <b>description</b>   | holding plate for probe mounting pos. lower L 35mm W 12mm H 4mm SS  |                 |                     |

|  |  |                 |                        |
|--|--|-----------------|------------------------|
|  |  |                 |                        |
| <b>GEV No.</b>   | 551462   | <b>Ref. No.</b> | 12021987<br>Z718446000 |
| <b>description</b>   | holding plate for temperature probe L 35mm W 35mm H 2mm hole ø 4mm |                 |                        |
| <b>For models:</b>   | LVC-21W  |                 |                        |

screw connections

|  |                         |                 |                        |
|--|-------------------------|-----------------|------------------------|
|   |                         |                 |                        |
| <b>GEV No.</b>   | 550366                  | <b>Ref. No.</b> | 12037422<br>RT30140163 |
| <b>description</b>   | screw for thermocouple  |                 |                        |
| <b>accessories for</b>   | 550366                  |                 |                        |
|  |                         |                 |                        |
| <b>GEV No.</b>   | 550365                  | <b>Ref. No.</b> | 12037350<br>RT30140162 |
| <b>description</b>   | gasket for thermocouple |                 |                        |

|  |  |                 |                     |
|--|--|-----------------|---------------------|
|  |  |                 |                     |
| <b>GEV No.</b>   | 691086   | <b>Ref. No.</b> | 12023581<br>R662629 |
| <b>description</b>   | union screw  |                 |                     |
| <b>For models:</b>   | ACE-061, ACE-101, ACE-102, ACE-201, ACE-202, ACG-061, ACG-101, ACG-102, ACG-201, ACG-202, AE-061, AE-061W, AE-101, AE-101W, AE-102, AE-102W, AE-201, AE-202, AG-061, AG-061W, AG-101, AG-101W, AG-102, AG-102W, AG-201, AG-202, APE-061, APE-061W, APE-101, APE-101W, APE-102, APE-102W, APE-201, APE-202, APG-061, APG-061W, APG-101, APG-101W, APG-102, APG-102W, APG-201, APG-202, COE-061, COE-101, COE-102, COE-201, COE-202, COG-061, COG-101, COG-102...(Other models you can see in the webshop) |                 |                     |

|   |                         |                 |                        |
|---|-------------------------|-----------------|------------------------|
|  |                         |                 |                        |
| <b>GEV No.</b>  | 550365                  | <b>Ref. No.</b> | 12037350<br>RT30140162 |
| <b>description</b>  | gasket for thermocouple |                 |                        |

|   |  |                 |                     |
|---|--|-----------------|---------------------|
|  |  |                 |                     |
| <b>GEV No.</b>  | 691085   | <b>Ref. No.</b> | 12024247<br>R662652 |
| <b>description</b>  | sealing ring for probe   |                 |                     |
| <b>For models:</b>  | ACE-061, ACE-101, ACE-102, ACE-201, ACE-202, ACG-061, ACG-101, ACG-102, ACG-201, ACG-202, AE-061, AE-061W, AE-101, AE-101W, AE-102, AE-102W, AE-201, AE-202, AG-061, AG-061W, AG-101, AG-101W, AG-102, AG-102W, AG-201, AG-202, APE-061, APE-061W, APE-101, APE-101W, APE-102, APE-102W, APE-201, APE-202, APG-061, APG-061W, APG-101, APG-101W, APG-102, APG-102W, APG-201, APG-202, COE-061, COE-101, COE-102, COE-201, COE-202, COG-061, COG-101, COG-102...(Other models you can see in the webshop) |                 |                     |

electronics  
electronics accessories

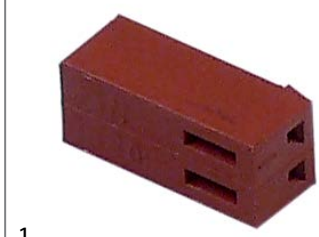
|  |  |                 |                     |
|--|--|-----------------|---------------------|
|  |  |                 |                     |
| <b>GEV No.</b>   | 401792   | <b>Ref. No.</b> | 12018408<br>R663092 |
| <b>description</b>   | female connector 2-pole  |                 |                     |
| <b>For models:</b>   | HCG-10-11, HCG-10-21, HCG-20-11, HCG-20-21, HCG-2-10-11, HCG-2-20-11, HCG-6-11, HEI-10-11, HEI-20-11, HEI-6-11, HGC-10-11, HGC-20-11, HGC-6-11, HGV-10-11, HGV-20-11, HMG-20-11, HMI-10-11, HMI-10-11UL, HMI-10-21, HMI-10-21UL, HMI-2-10-11, HMI-6-11, HMI-6-11UL, HMM-10-11, HMM-10-11UL, HMM-10-21, HMM-10-21UL, HMM-20-11, HMM-20-11UL, HMM-20-21, HMM-20-21UL, HMM-2-10-11, HMM-40-11-USMC, HMM-6-11, HMM-6-11UL, HVG-10-11, HVG-10-11UL, HVG-10-21, HVG-10-21UL, HVG-20-11, HVG-20-21, HVG-2-10-11, HVG-2-20-21, MFHMM-20-11, MFHVG-10-11, MFHVG-10-21 |                 |                     |



# Зип Общепит

## EPROMS



1

|                    |                             |                 |                        |
|--------------------|-----------------------------|-----------------|------------------------|
| <b>GEV No.</b>     | 403018                      | <b>Ref. No.</b> | 12040195<br>RT30400311 |
| <b>description</b> | EPROM type CPC CODE XS5.06S |                 |                        |



1

|                    |   |                 |                        |
|--------------------|---|-----------------|------------------------|
| <b>GEV No.</b>     | 400098  | <b>Ref. No.</b> | 12025859<br>RT30403001 |
| <b>description</b> | control PCB combi-steamer CD 101/CM 101 without EPROM |                 |                        |

## frequency converters



1

|                    |   |                 |          |
|--------------------|---|-----------------|----------|
| <b>GEV No.</b>     | 403922  | <b>Ref. No.</b> | 12048794 |
| <b>description</b> | frequency converter with heat sink for combi-steamer 200-240V 47-63 Hz L 150mm W 115mm H 90mm output frequency 0-550Hz 6.2A output current 2.3A SIEMENS SINAMICS G110 CPM110 AIN 6SL3211-0AB13-7UA1 |                 |          |
| <b>For models:</b> | ACE-061, AE-061, AE-061W, APE-061, APE-061W   |                 |          |



1

|                    |  |                 |                        |
|--------------------|--|-----------------|------------------------|
| <b>GEV No.</b>     | 400103   | <b>Ref. No.</b> | 12026014<br>RT30403020 |
| <b>description</b> | control PCB combi-steamer CM 61-202 L 460mm W 154mm 61-202 |                 |                        |



1

|                    |  |                 |          |
|--------------------|--|-----------------|----------|
| <b>GEV No.</b>     | 403935   | <b>Ref. No.</b> | 12048798 |
| <b>description</b> | frequency converter with heat sink for combi-steamer 200-240V L 150mm W 115mm H 90mm output frequency 0-550Hz 6.2A output current 2.3A   |                 |          |
| <b>For models:</b> | ACE-101, ACE-102, ACE-201, ACE-202, ACG-061, ACG-101, ACG-102, ACG-201, ACG-202, AE-101, AE-101W, AE-102, AE-102W, AE-201, AE-202, AG-061, AG-101, AG-102, AG-201, AG-202, APE-101, APE-101W, APE-102, APE-102W, APE-201, APE-202, APG-061, APG-101, APG-102, APG-201, APG-202 |                 |          |



1

|                    |                                 |                 |                        |
|--------------------|---------------------------------|-----------------|------------------------|
| <b>GEV No.</b>     | 400099                          | <b>Ref. No.</b> | 12026123<br>RT30403010 |
| <b>description</b> | control PCB combi-steamer CM101 |                 |                        |



1

|                    |   |                 |                        |
|--------------------|---|-----------------|------------------------|
| <b>GEV No.</b>     | 403319  | <b>Ref. No.</b> | 12026065<br>RT30403210 |
| <b>description</b> | control PCB combi-steamer CPC-Linie CM 61-202/G model since 10/1997 |                 |                        |

electric components





Зип Общепит.  
vsezip.ru

+7(812)987-08-81

|   |   |                 |   |
|---|---|-----------------|---|
|  |   |                 |   |
| 1   |   |                 |   |
| <b>GEV No.</b>  | 400862  | <b>Ref. No.</b> | 12016475<br>12040110<br>R663044<br>R663051<br>R663085 |
| <b>description</b>  | control PCB combi-steamer HME 611/1011  |                 |   |
| <b>For models:</b>  | HEM-10-11, HEM-20-11, HEM-6-11, HEP-10-11, HEP-20-11, HEP-6-11, HME-10-11, HME-10-21, HME-20-11, HME-20-21, HME-2-10-11, HME-2-20-11, HME-6-11, HMP-10-11, HMP-10-21, HMP-20-11, HMP-20-21, HMP-2-10-11, HMP-6-11 |                 |   |



|  |  |                 |                                   |
|--|--|-----------------|-----------------------------------|
|  |  |                 |                                   |
| 1  |  |                 |                                   |
| <b>GEV No.</b>   | 403743   | <b>Ref. No.</b> | 12024634<br>Z218030<br>Z218030000 |
| <b>description</b>   | control PCB for dishwasher L 75mm W 35mm suitable for FAGOR  |                 |                                   |
| <b>For models:</b>   | LA-AC-10M, LA-AC-10MP, LA-AC-13M, LA-AC-13MP, LA-AC-18M, LA-AC-18MP, LA-AC-25M, LA-AC-25MP, LA-E-10M, LA-E-10MP, LA-E-13M, LA-E-13MP, LA-E-18M, LA-E-18MP, LA-E-25M, LA-E-25MP, LA-V-10M, LA-V-10MP, LA-V-13M, LA-V-13MP, LA-V-18M, LA-V-18MP, LA-V-25M, LA-V-25MP, LB-AC-10M, LB-E-10M, LB-V-10M, LR-AC-10M, LR-AC-10MP, LR-AC-13M, LR-AC-13MP, LR-AC-18M, LR-AC-18MP, LR-AC-25M, LR-AC-25MP, LR-E-10M, LR-E-10MP, LR-E-13M, LR-E-13MP, LR-E-18M, LR-E-18MP, LR-E-25M, LR-E-25MP, LR-V-10M, LR-V-10MP, LR-V-13M, LR-V-13MP, LR-V-18M, LR-V-18MP, LR-V-25M...(Other models you can see in the webshop) |                 |                                   |

|   |                                    |                 |   |
|---|------------------------------------|-----------------|---|
|    |                                    |                 |   |
| 1   |                                    |                 |   |
| <b>GEV No.</b>  | 401475                             | <b>Ref. No.</b> | 12016327<br>12025432<br>RT4200002<br>RT4200002P |
| <b>description</b>  | control PCB combi-steamer SCC Line |                 |   |
| <b>accessories for</b>  | 401475                             |                 |   |
|  | <b>GEV No.</b>                     | 358791          | <b>Ref. No.</b> 12037374<br>RT40010224          |
| fine fuse size ø6.3x32mm 6.3A slow-acting rated 250V Qty 10 pcs                     |                                    |                 |   |

|  |                       |                 |   |
|--|-----------------------|-----------------|---|
|  |                       |                 |   |
| 1  |                       |                 |   |
| <b>GEV No.</b>   | 402226                | <b>Ref. No.</b> | 12009372<br>12023361<br>12046658<br>T913003 |
| <b>description</b>   | display combi-steamer |                 |   |

|   |   |                 |                     |
|---|---|-----------------|---------------------|
|  |   |                 |                     |
| 1   |   |                 |                     |
| <b>GEV No.</b>  | 400810                                    | <b>Ref. No.</b> | 12016516<br>Z233005 |
| <b>description</b>  | control PCB dishwasher FI-50 with display |                 |                     |
| <b>For models:</b>  | FI-50                                     |                 |                     |



|  |  |                 |                     |
|--|--|-----------------|---------------------|
|  |  |                 |                     |
| 1  |  |                 |                     |
| <b>GEV No.</b>   | 403632   | <b>Ref. No.</b> | 12010836<br>T623004 |
| <b>description</b>   | display for combi-steamer VPE202 L 195mm W 145mm |                 |                     |
| <b>For models:</b>   | VPE-102, VPE-202                                 |                 |                     |

|  |                                  |                 |  |
|--|----------------------------------|-----------------|--|
|  |                                  |                 |  |
| 1  |                                  |                 |  |
| <b>GEV No.</b>   | 402147                           | <b>Ref. No.</b> | 12029542<br>6021250061                 |
| <b>description</b>   | display PCB blast freezer ATM101 |                 |  |
| <b>For models:</b>   | ATM-051, ATM-101                 |                 |  |
| <b>accessories for</b>   | 402147                           |                 |  |
|   | <b>GEV No.</b>                   | 403056          | <b>Ref. No.</b> 12031295<br>6003010194 |
| keypad foil blast freezer ATM101 L 200mm W 60mm buttons 8                            |                                  |                 |  |

Зип Общепит

vsezip.ru

+7(812)987-08-81

|   |  |                 |   |
|---|--|-----------------|---|
|  |  |                 |   |
| 1   |  |                 |   |
| <b>GEV No.</b>  | 403076   | <b>Ref. No.</b> | 12009355<br>12024311<br>12046671<br>T533001 |
| <b>description</b>  | display PCB combi-steamer COE061 L 160mm W 110mm with potentiometer  |                 |   |
| <b>For models:</b>  | ACE-061, ACE-101, ACE-102, ACE-201, ACE-202, ACG-061, ACG-101, ACG-102, ACG-201, ACG-202, AE-061, AE-101, APE-061, APE-101, COE-061, COE-101, COE-102, COE-201, COE-202, COG-061, COG-101, COG-102, COG-201, COG-202 |                 |   |
| <b>accessories for</b>  | 403076   |                 |   |
|  |  |                 |   |
| <b>GEV No.</b>  | 402230   | <b>Ref. No.</b> | 12007938<br>12024255<br>12097540<br>T553003 |
| PCB for combi-steamer   |  |                 |   |

|  |  |                 |          |
|--|--|-----------------|----------|
|  |  |                 |          |
| 1  |  |                 |          |
| <b>GEV No.</b>   | 401897                                     | <b>Ref. No.</b> | 12016770 |
| <b>description</b>   | keypad PCB combi-steamer HGP1021           |                 |          |
| <b>For models:</b>   | HEP-10-21, HEP-20-21, HGP-10-21, HGP-20-21 |                 |          |

|   |  |                 |                     |
|---|--|-----------------|---------------------|
|  |  |                 |                     |
| 1   |  |                 |                     |
| <b>GEV No.</b>  | 401719   | <b>Ref. No.</b> | 12018452<br>T303018 |
| <b>description</b>  | display PCB combi-steamer HEI 1021/HGV 1021  |                 |                     |
| <b>For models:</b>  | HEI-10-21, HEI-20-21, HEM-10-21, HEM-20-21, HGC-10-21, HGC-20-21, HGV-10-21, HGV-20-21 |                 |                     |

|  |  |                 |                     |
|--|--|-----------------|---------------------|
|  |  |                 |                     |
| 1  |  |                 |                     |
| <b>GEV No.</b>   | 401788   | <b>Ref. No.</b> | 12024457<br>P613005 |
| <b>description</b>   | main PCB washing machine LA 10-13-18-25  |                 |                     |
| <b>For models:</b>   | LA-18MP, LA-AC-10MP, LA-AC-13MP, LA-AC-18MP, LA-AC-25MP, LA-E-10MP, LA-E-13MP, LA-E-18MP, LA-E-25MP, LA-V-10MP, LA-V-13MP, LA-V-18MP, LA-V-25MP, LF-13MPP, LF-18MPP, LF-25MPP, LF-8MPP, LR-AC-10MP, LR-AC-13MP, LR-AC-18MP, LR-AC-25MP, LR-E-10MP, LR-E-13MP, LR-E-18MP, LR-E-25MP, LR-V-10MP, LR-V-13MP, LR-V-18MP, LR-V-25MP |                 |                     |

|   |   |                 |                     |
|---|---|-----------------|---------------------|
|  |   |                 |                     |
| 1   |   |                 |                     |
| <b>GEV No.</b>  | 403237  | <b>Ref. No.</b> | 12024028<br>Z713017 |
| <b>description</b>  | display PCB dishwasher AD15/21/48 L 100mm W 35mm  |                 |                     |
| <b>For models:</b>  | AD-120, AD-120B, AD-120BBTDD-UK, AD-120C, AD-120HY, AD-15, AD-15D, AD-20C-UK, AD-21, AD-21B, AD-21BDD, AD-21C, AD-21D, AD-21DD, AD-45BBT, AD-48, AD-48B, AD-48BDD, AD-48C, AD-48D, AD-48DD, AD-48HY, AD-64, AD-64B, AD-64BBT, AD-64BDD, AD-64BTDD, AD-64C, AD-64D, AD-64DD, AD-64HY, AD-72, AD-90, AD-90BA, AD-90BBT, AD-90BDD, AD-90DD, ADE-120, ADE-120B, CO-112, CO-112B, CO-112BDD, CO-112DD, CO-172, CO-172B, CO-172BDD, CO-172DD, CO-352-COLD, CO-352-COLD-B, CO-352-COLD-B-DD... (Other models you can see in the webshop) |                 |                     |

|  |   |                 |                        |
|--|---|-----------------|------------------------|
|  |   |                 |                        |
| 1  |   |                 |                        |
| <b>GEV No.</b>   | 401487  | <b>Ref. No.</b> | 12025785<br>RT30403040 |
| <b>description</b>   | PCB combi-steamer CD 101/CM 101 with axial flow fan for fan motor |                 |                        |

|   |  |                 |                     |
|---|--|-----------------|---------------------|
|  |  |                 |                     |
| 1   |  |                 |                     |
| <b>GEV No.</b>  | 401720   | <b>Ref. No.</b> | 12018666<br>T303019 |
| <b>description</b>  | keypad PCB combi-steamer HEI 1021/HGV 1021 buttons 4   |                 |                     |
| <b>For models:</b>  | HEI-10-21, HEI-20-21, HEM-10-21, HEM-20-21, HEP-10-21, HEP-20-21, HGC-10-21, HGC-20-21, HGP-10-21, HGP-20-21, HGV-10-21, HGV-20-21 |                 |                     |

|  |  |                 |                        |
|--|--|-----------------|------------------------|
|  |  |                 |                        |
| 1  |  |                 |                        |
| <b>GEV No.</b>   | 401662                                 | <b>Ref. No.</b> | 12025798<br>RT4200004P |
| <b>description</b>   | PCB combi-steamer CM101 conversion kit |                 |                        |



Зип Общепит

vsezip.ru

+7(812)987-08-81



1

|                    |  |                 |                                |
|--------------------|--|-----------------|--------------------------------|
| <b>GEV No.</b>     | 401789   | <b>Ref. No.</b> | 12017191<br>T083002<br>T303048 |
| <b>description</b> | PCB combi-steamer HCG1011  |                 |                                |
| <b>For models:</b> | HCG-10-11, HCG-10-21, HCG-20-11, HCG-20-21, HCG-2-10-11, HCG-2-20-11, HCG-6-11, HGC-10-11, HGC-10-21, HGC-20-11, HGC-20-21, HGC-6-11, HGP-10-21, HGP-20-21, HGV-10-11, HGV-10-21, HGV-20-11, HGV-20-21, HVG-10-11, HVG-10-11UL, HVG-10-21, HVG-10-21UL, HVG-20-11, HVG-20-21, HVG-2-10-11, HVG-2-20-21, MFHVG-10-11, MFHVG-10-21 |                 |                                |



1

|                    |   |                 |                     |
|--------------------|---|-----------------|---------------------|
| <b>GEV No.</b>     | 400860  | <b>Ref. No.</b> | 12018459<br>R743013 |
| <b>description</b> | PCB combi-steamer t.max. 270°C  |                 |                     |
| <b>For models:</b> | HCG-10-11, HCG-10-21, HCG-20-11, HCG-20-21, HCG-2-10-11, HCG-2-20-11, HCG-6-11, HEI-10-11, HEI-20-11, HEI-6-11, HGC-10-11, HGC-20-11, HGC-6-11, HGV-10-11, HGV-20-11, HMG-10-11, HMG-10-21, HMG-20-11, HMG-2-10-11, HMG-6-11, HMI-10-11, HMI-10-21, HMI-2-10-11, HMI-6-11, HMM-10-11, HMM-10-21, HMM-20-11, HMM-20-21, HMM-2-10-11, HMM-2-20-11, HMM-6-11, HVG-10-11, HVG-10-11UL, HVG-10-21, HVG-10-21UL, HVG-20-11, HVG-20-21, HVG-2-10-11, HVG-2-20-21, MFHVG-10-11, MFHVG-10-21 |                 |                     |



1

|                    |  |                 |                     |
|--------------------|--|-----------------|---------------------|
| <b>GEV No.</b>     | 401721                                     | <b>Ref. No.</b> | 12018453<br>T353003 |
| <b>description</b> | PCB combi-steamer HEI 1021/HGV 1021        |                 |                     |
| <b>For models:</b> | HEI-10-21, HEI-20-21, HGC-10-21, HGC-20-21 |                 |                     |

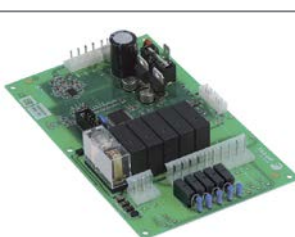

1

|                    |   |                 |                                 |
|--------------------|---|-----------------|---------------------------------|
| <b>GEV No.</b>     | 402225  | <b>Ref. No.</b> | 12024266<br>12046670<br>T553002 |
| <b>description</b> | PCB combi-steamer VE101/202   |                 |                                 |
| <b>For models:</b> | ACE-061, ACE-101, AE-061, AE-061W, AE-101, AE-101W, AE-102, AE-102W, AE-201, AE-202, AG-061, AG-061W, AG-101, AG-101W, AG-102, AG-102W, AG-201, AG-202, APE-061, APE-061W, APE-101, APE-101W, APE-102, APE-102W, APE-201, APE-202, APG-061, APG-061W, APG-101, APG-101W, APG-102, APG-102W, APG-201, APG-202, VE-061, VE-101, VE-102, VE-201, VE-202, VG-101, VG-102, VG-201, VG-202, VPE-061, VPE-101, VPE-102, VPE-201, VPE-202, VPG-101, VPG-102...(Other models you can see in the webshop) |                 |                                 |



1

|                    |   |                 |                     |
|--------------------|---|-----------------|---------------------|
| <b>GEV No.</b>     | 400863  | <b>Ref. No.</b> | 12017162<br>R663004 |
| <b>description</b> | PCB combi-steamer HMP 611/1011/2011   |                 |                     |
| <b>For models:</b> | HEP-10-11, HEP-20-11, HEP-6-11, HMP-10-11, HMP-10-21, HMP-20-11, HMP-20-21, HMP-2-10-11, HMP-6-11 |                 |                     |



1

|                    |   |                 |                     |
|--------------------|---|-----------------|---------------------|
| <b>GEV No.</b>     | 403308  | <b>Ref. No.</b> | 12008750<br>Z213073 |
| <b>description</b> | PCB dishwasher AD-72/48/64 L 128mm W 118mm suitable for FAGOR with housing H 55mm for dishwasher Qty 1 pcs  |                 |                     |
| <b>For models:</b> | AD-120, AD-120B, AD-120BBTDD-UK, AD-120C, AD-120CW, AD-120HY, AD-15, AD-15D, AD-20C-UK, AD-21, AD-21B, AD-21BDD, AD-21C, AD-21D, AD-21DD, AD-21W, AD-45BBT, AD-48, AD-48B, AD-48BDD, AD-48C, AD-48D, AD-48DD, AD-48HY, AD-48W, AD-64, AD-64B, AD-64BBT, AD-64BDD, AD-64BTDD, AD-64C, AD-64CW, AD-64D, AD-64DD, AD-64HY, AD-72, AD-72W, AD-90, AD-90BA, AD-90BBT, AD-90BDD, AD-90DD, ADE-120, ADE-120B, CO-112, CO-112B, CO-112BDD, CO-112DD, CO-142W, CO-142WDD...(Other models you can see in the webshop) |                 |                     |



1

|                    |                                 |                 |                        |
|--------------------|---------------------------------|-----------------|------------------------|
| <b>GEV No.</b>     | 400110                          | <b>Ref. No.</b> | 12026627<br>RT30403100 |
| <b>description</b> | PCB combi-steamer level control |                 |                        |



Зип Общепит

vsezip.ru

+7(812)987-08-81

electric components

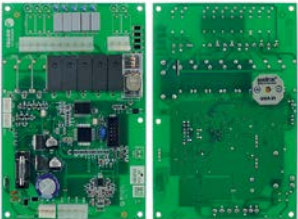

1

|                    |                           |                 |          |
|--------------------|---------------------------|-----------------|----------|
| <b>GEV No.</b>     | 403633                    | <b>Ref. No.</b> | 12016866 |
| <b>description</b> | PCB for boiler VPE202     |                 |          |
| <b>For models:</b> | VPE-102, VPE-201, VPE-202 |                 |          |



1

|                    |   |                 |   |
|--------------------|---|-----------------|---|
| <b>GEV No.</b>     | 402230  | <b>Ref. No.</b> | 12007938<br>12024255<br>12097540<br>T553003 |
| <b>description</b> | PCB for combi-steamer   |                 |   |
| <b>For models:</b> | COE-061, COE-101, COE-102, COE-201, COE-202, COG-061, COG-101, COG-102, COG-201, COG-202, VE-061, VE-101, VE-102, VE-201, VE-202, VG-101, VG-102, VG-201, VG-202, VPE-061, VPE-101, VPE-102, VPE-201, VPE-202, VPG-101, VPG-102, VPG-201, VPG-202 |                 |   |



1

|                    |   |                 |          |
|--------------------|---|-----------------|----------|
| <b>GEV No.</b>     | 403923  | <b>Ref. No.</b> | 12046673 |
| <b>description</b> | PCB for combi-steamer 61/101 L 150mm W 100mm suitable for FAGOR   |                 |          |
| <b>For models:</b> | ACG-061, ACG-101, ACG-102, ACG-201, ACG-202, AG-061, AG-061W, AG-101, AG-101W, AG-102, AG-102W, AG-201, AG-202, APG-061, APG-061W, APG-101, APG-101W, APG-102, APG-102W, APG-201, APG-202 |                 |          |

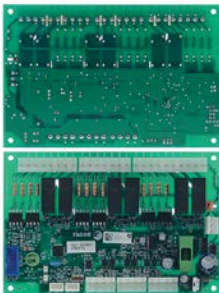

1

|                    |  |                 |          |
|--------------------|--|-----------------|----------|
| <b>GEV No.</b>     | 403932   | <b>Ref. No.</b> | 12130677 |
| <b>description</b> | PCB for combi-steamer L 150mm W 100mm suitable for FAGOR   |                 |          |
| <b>For models:</b> | ACG-061, ACG-101, ACG-102, ACG-201, ACG-202, AG-061, AG-101, AG-102, AG-201, AG-202, APG-061, APG-101, APG-102, APG-201, APG-202 |                 |          |

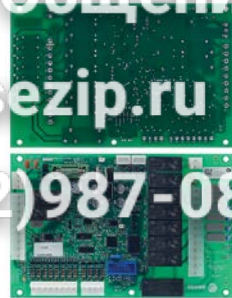

1

|                    |   |                 |          |
|--------------------|---|-----------------|----------|
| <b>GEV No.</b>     | 403934  | <b>Ref. No.</b> | 12046659 |
| <b>description</b> | PCB for combi-steamer L 155mm W 100mm   |                 |          |
| <b>For models:</b> | ACE-061, ACE-101, ACE-102, ACE-201, ACE-202, ACG-061, ACG-101, ACG-102, ACG-201, ACG-202, AE-061, AE-061W, AE-101, AE-101W, AE-102, AE-102W, AE-201, AE-202, AG-061, AG-061W, AG-101, AG-101W, AG-102, AG-102W, AG-201, AG-202, APE-061, APE-061W, APE-101, APE-101W, APE-102, APE-102W, APE-201, APE-202, APG-061, APG-061W, APG-101, APG-101W, APG-102, APG-102W, APG-201, APG-202, COE-061, COE-101, COG-061, COG-101, VE-061, VE-101, VG-101, VPE-061...(Other models you can see in the webshop) |                 |          |



1

|                    |  |                 |          |
|--------------------|--|-----------------|----------|
| <b>GEV No.</b>     | 403931   | <b>Ref. No.</b> | 12130672 |
| <b>description</b> | PCB for combi-steamer L 155mm W 100mm suitable for FAGOR   |                 |          |
| <b>For models:</b> | ACE-061, ACE-101, ACE-102, ACE-201, ACE-202, ACG-061, ACG-101, ACG-102, ACG-201, ACG-202, AE-061, AE-101, AE-102, AE-201, AE-202, AG-061, AG-101, AG-102, AG-201, AG-202, APE-061, APE-101, APE-102, APE-201, APE-202, APG-061, APG-101, APG-102, APG-201, APG-202 |                 |          |

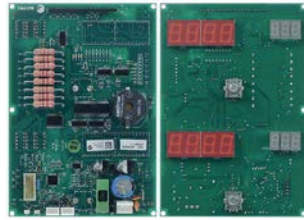

1

|                    |  |                 |          |
|--------------------|--|-----------------|----------|
| <b>GEV No.</b>     | 403933   | <b>Ref. No.</b> | 12130674 |
| <b>description</b> | PCB for combi-steamer L 160mm W 110mm  |                 |          |
| <b>For models:</b> | ACE-061, ACE-101, ACE-102, ACE-201, ACE-202, ACG-061, ACG-101, ACG-102, ACG-201, ACG-202, AE-061, AE-101, APE-061, APE-101 |                 |          |

Зип Общепит

vsezip.ru

+7(812)987-08-81



1

|                    |  |                 |          |
|--------------------|--|-----------------|----------|
| <b>GEV No.</b>     | 403930   | <b>Ref. No.</b> | 12046672 |
| <b>description</b> | PCB for combi-steamer L 176mm W 96mm   |                 |          |
| <b>For models:</b> | ACE-061, ACE-101, AE-061, AE-061W, AE-101, AE-101W, AE-102, AE-102W, AE-201, AE-202, AG-061, AG-061W, AG-101, AG-101W, AG-102, AG-102W, AG-201, AG-202, APE-061, APE-101, VE-061, VE-101, VG-101 |                 |          |



1

|                    |   |                 |                     |
|--------------------|---|-----------------|---------------------|
| <b>GEV No.</b>     | 401786  | <b>Ref. No.</b> | 12016954<br>R693058 |
| <b>description</b> | temperatur p.c.b combi-steamer HMI1011  |                 |                     |
| <b>For models:</b> | HMG-10-11UL, HMG-10-21UL, HMI-10-11UL, HMI-10-21UL, HMI-6-11UL, HMM-10-11UL, HMM-10-21UL, HMM-20-11, HMM-20-11UL, HMM-20-21UL, HMM-40-11-USMC, HMM-6-11UL, HVG-10-11, HVG-10-11UL, HVG-10-21, HVG-10-21UL, HVG-2-10-11, MFHMM-20-11, MFHVG-10-11, MFHVG-10-21 |                 |                     |



1

|                    |  |                 |          |
|--------------------|--|-----------------|----------|
| <b>GEV No.</b>     | 403918   | <b>Ref. No.</b> | 12130675 |
| <b>description</b> | PCB for combi-steamer L 177mm W 96mm suitable for FAGOR  |                 |          |
| <b>For models:</b> | ACE-061, ACE-101, AE-061, AE-101, AE-102, AE-201, AE-202, AG-061, AG-101, AG-102, AG-201, AG-202, APE-061, APE-101 |                 |          |

central units



1

|                    |   |                 |                     |
|--------------------|---|-----------------|---------------------|
| <b>GEV No.</b>     | 401790  | <b>Ref. No.</b> | 12023465<br>Z953004 |
| <b>description</b> | control box burner regulation   |                 |                     |
| <b>For models:</b> | COG-061, COG-101, COG-201, GA-20, GA-40, HCG-10-11, HCG-10-21, HCG-20-11, HCG-20-21, HCG-2-10-11, HCG-2-20-11, HCG-6-11, HGC-10-11, HGC-20-11, HGC-6-11, HGV-10-11, HGV-20-11, HVG-10-11, HVG-10-21, HVG-20-11, HVG-20-21, HVG-2-10-11, HVG-2-20-21, VG-101, VG-201, VPG-101, VPG-201 |                 |                     |



1

|   |   |                 |   |
|---|---|-----------------|---|
| <b>GEV No.</b>  | 401629  | <b>Ref. No.</b> | 12026129<br>12026671<br>RT4000049<br>RT4000049P |
| <b>description</b>  | relay shroud I/O-Board SCC Line                               |                 |   |
| <b>accessories for</b>  | 401629  |                 |   |
|  | <b>GEV No.</b>  | 358786          | <b>Ref. No.</b> —                               |
|   | fine fuse size ø6.3x32mm 2A slow-acting rated 250V Qty 10 pcs |                 |   |



1

|                    |  |                 |                     |
|--------------------|--|-----------------|---------------------|
| <b>GEV No.</b>     | 402991   | <b>Ref. No.</b> | 12024809<br>Z213069 |
| <b>description</b> | control box for dishwasher 230V  |                 |                     |
| <b>For models:</b> | AD-120, AD-120B, AD-120C, AD-120HY, AD-15, AD-15D, AD-20C-UK, AD-21, AD-21B, AD-21BDD, AD-21C, AD-21D, AD-21DD, AD-45BBT, AD-48, AD-48B, AD-48BDD, AD-48C, AD-48D, AD-48DD, AD-48HY, AD-64, AD-64B, AD-64BBT, AD-64BDD, AD-64C, AD-64D, AD-64DD, AD-64HY, AD-72, AD-90, AD-90DD, ADE-120, ADE-120B |                 |                     |



1

|                    |   |                 |                     |
|--------------------|---|-----------------|---------------------|
| <b>GEV No.</b>     | 401787  | <b>Ref. No.</b> | 12016841<br>R693007 |
| <b>description</b> | temperatur p.c.b combi-steamer HEI 6/11 HMI 6/11 °C |                 |                     |



keypads

front foils

Зип Общепит

vsezip.ru

+7(812)987-08-81



1

|                    |  |                 |                        |
|--------------------|--|-----------------|------------------------|
| <b>GEV No.</b>     | 403816   | <b>Ref. No.</b> | 12024760<br>T813005000 |
| <b>description</b> | front foil combi-steamer FAGOR L 480mm W 125mm |                 |                        |
| <b>For models:</b> | VE-061, VE-101, VE-201                         |                 |                        |



1

|                    |  |                 |                     |
|--------------------|--|-----------------|---------------------|
| <b>GEV No.</b>     | 400871   | <b>Ref. No.</b> | 12020786<br>R723008 |
| <b>description</b> | front foil combi-steamer HCG611  |                 |                     |
| <b>For models:</b> | HCG-10-11, HCG-10-21, HCG-20-11, HCG-20-21, HCG-2-10-11, HCG-2-20-11, HCG-6-11, HMG-10-11, HMG-10-21, HMG-20-11, HMG-2-10-11, HMG-6-11 |                 |                     |



1

|                    |  |                 |                     |
|--------------------|--|-----------------|---------------------|
| <b>GEV No.</b>     | 400872   | <b>Ref. No.</b> | 12018460<br>R663014 |
| <b>description</b> | front foil combi-steamer HEI 6/11 HMI 6/11   |                 |                     |
| <b>For models:</b> | HME-10-11, HME-10-21, HME-20-11, HME-20-21, HME-2-10-11, HME-2-20-11, HME-6-11, HMI-6-11, HMI-6-11UL, HMM-10-11, HMM-10-21, HMM-20-11, HMM-2-10-11, HMM-40-11-USMC, HMM-6-11, HMM-6-11UL, HMP-10-21, HMP-20-11, HMP-6-11 |                 |                     |



1

|                    |  |                 |                     |
|--------------------|--|-----------------|---------------------|
| <b>GEV No.</b>     | 401723   | <b>Ref. No.</b> | 12019869<br>R693014 |
| <b>description</b> | front foil combi-steamer HEI611/1011/1021 L 365mm W 98mm |                 |                     |
| <b>For models:</b> | HMI-10-11, HMI-10-21, HMI-2-10-11, HMI-6-11              |                 |                     |



1

|                    |  |                 |                     |
|--------------------|--|-----------------|---------------------|
| <b>GEV No.</b>     | 401783   | <b>Ref. No.</b> | 12018494<br>R673067 |
| <b>description</b> | front foil combi-steamer HEM 10/11-20/11 L 480mm W 100mm |                 |                     |
| <b>For models:</b> | HEM-10-11, HEM-20-11                                     |                 |                     |



1

|                    |                                      |                 |                     |
|--------------------|--------------------------------------|-----------------|---------------------|
| <b>GEV No.</b>     | 400866                               | <b>Ref. No.</b> | 12019113<br>R693030 |
| <b>description</b> | front foil combi-steamer HMI1011     |                 |                     |
| <b>For models:</b> | HMI-10-11UL, HMI-10-21UL, HMI-6-11UL |                 |                     |





Зип Общепит

vsezip.ru

+7(812)987-08-81

|   |                              |                 |                     |
|---|------------------------------|-----------------|---------------------|
|  |                              |                 |                     |
| 1   |                              |                 |                     |
| <b>GEV No.</b>  | 505205                       | <b>Ref. No.</b> | 12020129<br>Z732901 |
| <b>description</b>  | front foil dishwasher ECO120 |                 |                     |
| <b>For models:</b>  | ECO-120, ECO-120B            |                 |                     |

|   |   |                 |                     |
|---|---|-----------------|---------------------|
|  |   |                 |                     |
| 1   |   |                 |                     |
| <b>GEV No.</b>  | 401843  | <b>Ref. No.</b> | 12017916<br>Z322902 |
| <b>description</b>  | front foil dishwasher ECO200 L 645mm W 173mm                |                 |                     |
| <b>For models:</b>  | ECO-200, ECO-200D, ECO-200H, ECO-200HD, ECO-200HI, ECO-200I |                 |                     |

|   |  |                 |                     |
|---|--|-----------------|---------------------|
|  |  |                 |                     |
| 1   |  |                 |                     |
| <b>GEV No.</b>  | 505125   | <b>Ref. No.</b> | 12020028<br>Z710516 |
| <b>description</b>  | front foil dishwasher FI-100   |                 |                     |
| <b>For models:</b>  | ECO-120, ECO-120B, ECO-160D, ECO-160I, ECO-200D, ECO-200I, ECO-280D, ECO-280I, ECO-370D, ECO-370I, ECO-460D, ECO-460I, ECO-550D, ECO-550I, FI-100, FI-100AR, FI-100B, FI-100I, FI-120, FI-120B, FI-120W, FI-160D, FI-160I, FI-200D, FI-200I, FI-280D, FI-280I, FI-370D, FI-370I, FI-460D, FI-460I, FI-550D, FI-550I, FI-80, FI-80W |                 |                     |

|   |                            |                 |                     |
|---|----------------------------|-----------------|---------------------|
|  |                            |                 |                     |
| 1   |                            |                 |                     |
| <b>GEV No.</b>  | 505117                     | <b>Ref. No.</b> | 12020315<br>Z202909 |
| <b>description</b>  | front foil dishwasher FI30 |                 |                     |
| <b>For models:</b>  | FI-30                      |                 |                     |

|   |  |                 |          |
|---|--|-----------------|----------|
|  |  |                 |          |
| 1   |  |                 |          |
| <b>GEV No.</b>  | 403240   | <b>Ref. No.</b> | 12025130 |
| <b>description</b>  | front foil dishwasher FI30 grey model FI30 suitable for FAGOR L 585mm W 62.5mm |                 |          |
| <b>For models:</b>  | FI-30, FI-30AR, FI-30AR+DD, FI-30-UK   |                 |          |

|   |  |                 |                     |
|---|--|-----------------|---------------------|
|  |  |                 |                     |
| 1   |  |                 |                     |
| <b>GEV No.</b>  | 403238   | <b>Ref. No.</b> | 12023961<br>Z222903 |
| <b>description</b>  | front foil dishwasher FI48 grey model FI-48B suitable for FAGOR L 585mm W 62.5mm |                 |                     |
| <b>For models:</b>  | FI-48, FI-48B  |                 |                     |

|  |   |                 |                     |
|--|---|-----------------|---------------------|
|  |   |                 |                     |
| 1  |   |                 |                     |
| <b>GEV No.</b>   | 505119  | <b>Ref. No.</b> | 12020146<br>Z212910 |
| <b>description</b>   | front foil dishwasher FI-48 run-time 120/180s |                 |                     |
| <b>For models:</b>   | FI-43, FI-43W                                 |                 |                     |

|  |  |                 |                     |
|--|--|-----------------|---------------------|
|  |  |                 |                     |
| 1  |  |                 |                     |
| <b>GEV No.</b>   | 505120   | <b>Ref. No.</b> | 12020147<br>Z222902 |
| <b>description</b>   | front foil dishwasher FI-48B model FI-48B drain pump |                 |                     |
| <b>For models:</b>   | FI-48B   |                 |                     |

|  |   |                 |                     |
|--|---|-----------------|---------------------|
|  |   |                 |                     |
| 1  |   |                 |                     |
| <b>GEV No.</b>   | 505118                                  | <b>Ref. No.</b> | 12019162<br>Z232901 |
| <b>description</b>   | front foil dishwasher FI-50 model FI-50 |                 |                     |
| <b>For models:</b>   | FI-50                                   |                 |                     |

|  |  |                 |                     |
|--|--|-----------------|---------------------|
|  |  |                 |                     |
| 1  |  |                 |                     |
| <b>GEV No.</b>   | 505121                                       | <b>Ref. No.</b> | 12018990<br>Z242901 |
| <b>description</b>   | front foil dishwasher FI-64 run-time 90/180s |                 |                     |
| <b>For models:</b>   | FI-64, FI-64W                                |                 |                     |

|  |                             |                 |                     |
|--|-----------------------------|-----------------|---------------------|
|  |                             |                 |                     |
| 1  |                             |                 |                     |
| <b>GEV No.</b>   | 505124                      | <b>Ref. No.</b> | 12018622<br>Z262906 |
| <b>description</b>   | front foil dishwasher FI-72 |                 |                     |
| <b>For models:</b>   | FI-72                       |                 |                     |

|  |                                     |                 |                     |
|--|-------------------------------------|-----------------|---------------------|
|  |                                     |                 |                     |
| 1  |                                     |                 |                     |
| <b>GEV No.</b>   | 505123                              | <b>Ref. No.</b> | 12018989<br>Z252901 |
| <b>description</b>   | front foil warewashing FI-64B/FI64W |                 |                     |
| <b>For models:</b>   | FI-64B                              |                 |                     |

|  |   |                 |                     |
|--|---|-----------------|---------------------|
|  |   |                 |                     |
| 1  |   |                 |                     |
| <b>GEV No.</b>   | 505122  | <b>Ref. No.</b> | 12019191<br>Z258501 |
| <b>description</b>   | front foil warewashing FI-64B/FI64W model FI-64B/FI64W drain pump |                 |                     |
| <b>For models:</b>   | FI-64B, MF-64   |                 |                     |



Зип Общепит  
vsezip.ru

+7(812)987-08-81

1



|                    |             |                 |         |
|--------------------|-------------|-----------------|---------|
| <b>GEV No.</b>     | 505128      | <b>Ref. No.</b> | Z718502 |
| <b>description</b> | keypad foil |                 |         |

2



|                    |   |                 |                        |
|--------------------|---|-----------------|------------------------|
| <b>GEV No.</b>     | 403056  | <b>Ref. No.</b> | 12031295<br>6003010194 |
| <b>description</b> | keypad foil blast freezer ATM101 L 200mm W 60mm buttons 8 |                 |                        |
| <b>For models:</b> | ATM-051, ATM-101  |                 |                        |

1



|                    |  |                 |                                 |
|--------------------|--|-----------------|---------------------------------|
| <b>GEV No.</b>     | 400867   | <b>Ref. No.</b> | 12019107<br>12019204<br>T013006 |
| <b>description</b> | keypad foil combi-steamer HCG611/1011  |                 |                                 |
| <b>For models:</b> | HCG-10-11, HCG-10-21, HCG-20-11, HCG-20-21, HCG-2-10-11, HCG-2-20-11, HCG-6-11, HGC-10-11, HGC-20-11, HGC-6-11 |                 |                                 |

1



|                    |   |                 |                     |
|--------------------|---|-----------------|---------------------|
| <b>GEV No.</b>     | 400868  | <b>Ref. No.</b> | 12019010<br>R723022 |
| <b>description</b> | keypad foil combi-steamer HCG611/1011   |                 |                     |
| <b>For models:</b> | HCG-10-11, HCG-10-21, HCG-2-10-11, HCG-6-11, HMG-10-11, HMG-10-21, HMG-20-11, HMG-2-10-11, HMG-6-11 |                 |                     |

1



|                    |   |                 |                     |
|--------------------|---|-----------------|---------------------|
| <b>GEV No.</b>     | 401718  | <b>Ref. No.</b> | 12018060<br>T353004 |
| <b>description</b> | keypad foil combi-steamer HEI 1021/HGV 1021 L 670mm W 160mm |                 |                     |
| <b>For models:</b> | HEI-10-21, HEI-20-21  |                 |                     |

1



|                    |  |                 |                     |
|--------------------|--|-----------------|---------------------|
| <b>GEV No.</b>     | 400865   | <b>Ref. No.</b> | 12019205<br>R673000 |
| <b>description</b> | keypad foil combi-steamer HEM1011/2011 HME1011/1021/2011   |                 |                     |
| <b>For models:</b> | HME-10-11, HME-10-21, HME-20-11, HME-20-21, HME-2-10-11, HME-2-20-11, HMP-10-11, HMP-10-21, HMP-20-11, HMP-20-21, HMP-2-10-11, HMP-2-20-11 |                 |                     |

1



|                    |   |                 |                     |
|--------------------|---|-----------------|---------------------|
| <b>GEV No.</b>     | 400869  | <b>Ref. No.</b> | 12020664<br>R693000 |
| <b>description</b> | keypad foil combi-steamer HMI1011   |                 |                     |
| <b>For models:</b> | HMI-10-11, HMI-10-11UL, HMI-10-21, HMI-10-21UL, HMI-2-10-11, HMM-10-11, HMM-10-11UL, HMM-10-21, HMM-10-21UL, HMM-20-11, HMM-20-11UL, HMM-20-21, HMM-20-21UL, HMM-2-10-11, HMM-2-20-11, HMM-6-11 |                 |                     |



Зип Общепит  
vsezip.ru

+7(812)987-08-81



|                    |  |                 |                                 |
|--------------------|--|-----------------|---------------------------------|
| <b>GEV No.</b>     | 400864   | <b>Ref. No.</b> | 12020040<br>12020107<br>R743012 |
| <b>description</b> | keypad foil combi-steamer HMM2011/2021/22011                                   |                 |                                 |
| <b>For models:</b> | HMM-10-11, HMM-10-21, HMM-20-11, HMM-20-21, HMM-2-10-11, HMM-2-20-11, HMM-6-11 |                 |                                 |



|                    |                              |                 |                     |
|--------------------|------------------------------|-----------------|---------------------|
| <b>GEV No.</b>     | 505204                       | <b>Ref. No.</b> | 12019475<br>Z722901 |
| <b>description</b> | keypad foil dishwasher FI120 |                 |                     |
| <b>For models:</b> | FI-120, FI-120B              |                 |                     |



|                    |   |                 |                     |
|--------------------|---|-----------------|---------------------|
| <b>GEV No.</b>     | 400870  | <b>Ref. No.</b> | 12018349<br>R663010 |
| <b>description</b> | keypad foil combi-steamer HMP 611/1011/2011   |                 |                     |
| <b>For models:</b> | HME-10-11, HME-10-21, HME-2-10-11, HMP-10-11, HMP-10-21, HMP-20-11, HMP-20-21, HMP-2-10-11, HMP-2-20-11, HMP-6-11 |                 |                     |



|                    |  |                 |                     |
|--------------------|--|-----------------|---------------------|
| <b>GEV No.</b>     | 505108   | <b>Ref. No.</b> | 12020486<br>Z462901 |
| <b>description</b> | keypad foil dishwasher LVC12                   |                 |                     |
| <b>For models:</b> | LVC-12, LVC-15, LVC-21, LVR-10, LVR-14, LVR-20 |                 |                     |



|                    |                             |                 |                     |
|--------------------|-----------------------------|-----------------|---------------------|
| <b>GEV No.</b>     | 505126                      | <b>Ref. No.</b> | 12019909<br>Z742906 |
| <b>description</b> | keypad foil dishwasher FI80 |                 |                     |
| <b>For models:</b> | FI-80                       |                 |                     |



|                    |  |                 |                     |
|--------------------|--|-----------------|---------------------|
| <b>GEV No.</b>     | 505109   | <b>Ref. No.</b> | 12018909<br>Z412901 |
| <b>description</b> | keypad foil dishwasher LVC15                   |                 |                     |
| <b>For models:</b> | LVC-12, LVC-15, LVC-21, LVR-10, LVR-14, LVR-20 |                 |                     |

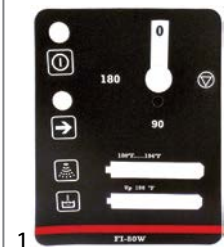

|                    |                              |                 |                     |
|--------------------|------------------------------|-----------------|---------------------|
| <b>GEV No.</b>     | 505127                       | <b>Ref. No.</b> | 12019473<br>Z748404 |
| <b>description</b> | keypad foil dishwasher FI180 |                 |                     |
| <b>For models:</b> | FI-80W                       |                 |                     |



|                    |                               |                 |                     |
|--------------------|-------------------------------|-----------------|---------------------|
| <b>GEV No.</b>     | 505115                        | <b>Ref. No.</b> | 12019307<br>Z482901 |
| <b>description</b> | keypad foil dishwasher LVC15D |                 |                     |
| <b>For models:</b> | LVC-15D                       |                 |                     |



|                    |   |                 |                     |
|--------------------|---|-----------------|---------------------|
| <b>GEV No.</b>     | 505113                                    | <b>Ref. No.</b> | 12018973<br>Z472902 |
| <b>description</b> | keypad foil dishwasher LVC15D/21D/14D/20D |                 |                     |
| <b>For models:</b> | LVR-14D                                   |                 |                     |



|                    |   |                 |         |
|--------------------|---|-----------------|---------|
| <b>GEV No.</b>     | 505114                                    | <b>Ref. No.</b> | Z492902 |
| <b>description</b> | keypad foil dishwasher LVC15D/21D/14D/20D |                 |         |



|                    |   |                 |                     |
|--------------------|---|-----------------|---------------------|
| <b>GEV No.</b>     | 505110  | <b>Ref. No.</b> | 12020451<br>Z442901 |
| <b>description</b> | keypad foil dishwasher LVC21                            |                 |                     |
| <b>For models:</b> | LVC-12, LVC-15, LVC-21, LVC-21W, LVR-10, LVR-14, LVR-20 |                 |                     |



Зип Общепит

vsezip.ru

+7(812)987-08-81

→ electric components



1

|                    |                               |                 |                     |
|--------------------|-------------------------------|-----------------|---------------------|
| <b>GEV No.</b>     | 505112                        | <b>Ref. No.</b> | 12019096<br>Z452901 |
| <b>description</b> | keypad foil dishwasher LVC21B |                 |                     |
| <b>For models:</b> | LVC-21B, LVR-20B              |                 |                     |



1

|                    |                               |                 |                     |
|--------------------|-------------------------------|-----------------|---------------------|
| <b>GEV No.</b>     | 505116                        | <b>Ref. No.</b> | 12018125<br>Z502901 |
| <b>description</b> | keypad foil dishwasher LVC21D |                 |                     |
| <b>For models:</b> | LVC-21D                       |                 |                     |



1

|                    |  |                 |                     |
|--------------------|--|-----------------|---------------------|
| <b>GEV No.</b>     | 505105   | <b>Ref. No.</b> | 12019135<br>Z392901 |
| <b>description</b> | keypad foil dishwasher LVR10                   |                 |                     |
| <b>For models:</b> | LVC-12, LVC-15, LVC-21, LVR-10, LVR-14, LVR-20 |                 |                     |



1

|                    |                              |                 |         |
|--------------------|------------------------------|-----------------|---------|
| <b>GEV No.</b>     | 505106                       | <b>Ref. No.</b> | Z402909 |
| <b>description</b> | keypad foil dishwasher LVR14 |                 |         |



1

|                    |   |                 |          |
|--------------------|---|-----------------|----------|
| <b>GEV No.</b>     | 403927  | <b>Ref. No.</b> | 12044109 |
| <b>description</b> | keypad foil for combi-steamer black L 540mm W 173mm                           |                 |          |
| <b>For models:</b> | ACE-061, ACE-101, ACE-102, ACE-201, ACE-202, AE-061, AE-101, APE-061, APE-101 |                 |          |



1

|                    |   |                 |          |
|--------------------|---|-----------------|----------|
| <b>GEV No.</b>     | 403928  | <b>Ref. No.</b> | 12044176 |
| <b>description</b> | keypad foil for combi-steamer black L 540mm W 173mm |                 |          |
| <b>For models:</b> | ACG-061, ACG-101, ACG-102, ACG-201, ACG-202         |                 |          |



1

|                    |  |                 |          |
|--------------------|--|-----------------|----------|
| <b>GEV No.</b>     | 403920   | <b>Ref. No.</b> | 12129465 |
| <b>description</b> | keypad foil for combi-steamer black suitable for FAGOR L 540mm W 173mm |                 |          |



1

|                    |                               |                 |                     |
|--------------------|-------------------------------|-----------------|---------------------|
| <b>GEV No.</b>     | 505202                        | <b>Ref. No.</b> | 12020127<br>Z712908 |
| <b>description</b> | keypad foil warewashing FI100 |                 |                     |
| <b>For models:</b> | FI-100, FI-100AR, FI-100B     |                 |                     |



electric components

Зип Общепит

vsezip.ru

+7(812)987-08-81



|                    |                               |                 |                     |
|--------------------|-------------------------------|-----------------|---------------------|
| <b>GEV No.</b>     | 505203                        | <b>Ref. No.</b> | 12020324<br>Z728501 |
| <b>description</b> | keypad foil warewashing FI120 |                 |                     |
| <b>For models:</b> | FI-120W, MF-120               |                 |                     |



|                    |                              |                 |         |
|--------------------|------------------------------|-----------------|---------|
| <b>GEV No.</b>     | 505201                       | <b>Ref. No.</b> | Z742901 |
| <b>description</b> | keypad foil warewashing FI80 |                 |         |

### membrane keypads



|                    |  |                 |          |
|--------------------|--|-----------------|----------|
| <b>GEV No.</b>     | 403466   | <b>Ref. No.</b> | 12024723 |
| <b>description</b> | membrane keypad dishwasher AD48/AD64 buttons 4 suitable for FAGOR Qty 1 pcs L 585mm W 50mm |                 |          |
| <b>For models:</b> | AD-45BBT, AD-48B, AD-48BDD, AD-48C, AD-64B, AD-64BBT, AD-64BDD, AD-64C                     |                 |          |



|                    |  |                 |          |
|--------------------|--|-----------------|----------|
| <b>GEV No.</b>     | 403467   | <b>Ref. No.</b> | 12023437 |
| <b>description</b> | membrane keypad dishwasher AD90 buttons 4 suitable for FAGOR Qty 1 pcs L 200mm W 120mm |                 |          |
| <b>For models:</b> | AD-90, AD-90DD   |                 |          |



|                    |  |                 |          |
|--------------------|--|-----------------|----------|
| <b>GEV No.</b>     | 401570   | <b>Ref. No.</b> | 12023215 |
| <b>description</b> | membrane keypad warewashing LA13 buttons 6 L 640mm W 160mm |                 |          |
| <b>For models:</b> | LA-13M, LB-AC-10M, LB-E-10M, LB-V-10M                      |                 |          |

### control panel



|                    |  |                 |          |
|--------------------|--|-----------------|----------|
| <b>GEV No.</b>     | 403637   | <b>Ref. No.</b> | 12044139 |
| <b>description</b> | keypad foil combi-steamer APE-061/101 L 540mm W 172mm thickness 1mm  |                 |          |
| <b>For models:</b> | ACE-061, ACE-101, AE-061, AE-061W, AE-101, AE-101W, AE-102, AE-102W, AE-201, AE-202, AG-061, AG-061W, AG-101, AG-101W, AG-102, AG-102W, AG-201, AG-202, APE-061, APE-101 |                 |          |

### solenoid valves

#### solenoid valves (water)

ELBI

straight



|                |        |                 |                        |
|----------------|--------|-----------------|------------------------|
| <b>GEV No.</b> | 373021 | <b>Ref. No.</b> | 12032024<br>RT30020330 |
|----------------|--------|-----------------|------------------------|

**description** solenoid valve double straight 230VAC inlet 3/4" outlet 11.5mm output 1x 4.7l/min DN10 ELBI

**spare parts for** 373021

|                |        |                 |   |
|----------------|--------|-----------------|---|
| <b>GEV No.</b> | 370467 | <b>Ref. No.</b> | — |
|----------------|--------|-----------------|---|

**description** solenoid valve filter suitable for ELBI

Table continues overleaf





Зип Общепит

vsezip.ru

+7(812)987-08-81

|   |                       |                 |   |
|---|-----------------------|-----------------|---|
| <b>spare parts for</b> 373021   |                       |                 |   |
|                          | <b>GEV No.</b> 371263 | <b>Ref. No.</b> | — |
| reducer ELBI type EATON (INVENSYS) flow rate 4.7l/min pressure range 0 up to 10bar tolerance ±15/25% grey |                       |                 |   |

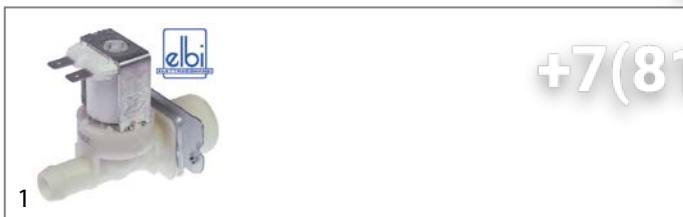

|   |                            |
|---|----------------------------|
| <b>GEV No.</b> 373018   | <b>Ref. No.</b> RT30020331 |
| <b>description</b> solenoid valve single straight 230VAC inlet 3/4" outlet 14mm DN10 ELBI |                            |

|   |                       |                 |   |
|---|-----------------------|-----------------|---|
| <b>spare parts for</b> 373018   |                       |                 |   |
|  | <b>GEV No.</b> 370467 | <b>Ref. No.</b> | — |
| solenoid valve filter suitable for ELBI   |                       |                 |   |



|   |                                  |
|---|----------------------------------|
| <b>GEV No.</b> 373025   | <b>Ref. No.</b> 12023921 Z611123 |
| <b>description</b> solenoid valve triple straight 230VAC inlet 3/4" outlet 11.5mm DN10 ELBI |                                  |

**For models:** AE-061, AE-061W, AE-101, AE-101W, AE-102, AE-102W, AE-201, AE-202, AG-061, AG-061W, AG-101, AG-101W, AG-102, AG-102W, AG-201, AG-202, APE-061, APE-061W, APE-101, APE-101W, APE-102, APE-102W, APE-201, APE-202, APG-061, APG-061W, APG-101, APG-101W, APG-102, APG-102W, APG-201, APG-202, HEM-10-11, HEM-20-11, HEM-6-11, HEP-10-11, HEP-20-11, HEP-6-11, LA-13M, LA-18MP, LA-25M, LA-AC-10M, LA-AC-10MA, LA-AC-10MP, LA-AC-13M, LA-AC-13MA, LA-AC-13MP, LA-AC-18M, LA-AC-18MA, LA-AC-18MP...(Other models you can see in the webshop)

|   |                       |                 |   |
|---|-----------------------|-----------------|---|
| <b>spare parts for</b> 373025   |                       |                 |   |
|  | <b>GEV No.</b> 370467 | <b>Ref. No.</b> | — |
| solenoid valve filter suitable for ELBI   |                       |                 |   |



|  |                                    |
|--|------------------------------------|
| <b>GEV No.</b> 370852  | <b>Ref. No.</b> 12032546 RT5000139 |
| <b>description</b> solenoid valve single straight 230VAC inlet 3/4" outlet 11.5mm DN10 |                                    |

|  |                       |                                    |
|--|-----------------------|------------------------------------|
|      | <b>GEV No.</b> 370851 | <b>Ref. No.</b> 12031080 RT5000138 |
| <b>description</b> solenoid valve double straight 230VAC inlet 3/4" outlet 11.5mm DN10 |                       |                                    |



|   |                          |
|---|--------------------------|
| <b>GEV No.</b> 370849   | <b>Ref. No.</b> 12115418 |
| <b>description</b> solenoid valve triple straight 220-240V/50-60Hz inlet 3/4" outlet 10.5 t.max. 90°C duty cycle 100% ELBI 369 plastic flow regulating valve inlet black  |                          |
| <b>For models:</b> AE-061, AE-061W, AE-101, AE-101W, AE-102, AE-102W, AE-201, AE-202, AG-061, AG-061W, AG-101, AG-101W, AG-102, AG-102W, AG-201, AG-202, APE-061, APE-061W, APE-101, APE-101W, APE-102, APE-102W, APE-201, APE-202, APG-061, APG-061W, APG-101, APG-101W, APG-102, APG-102W, APG-201, APG-202 |                          |

ROBERTSHAW/INVENSYS

*medium temperature:* 90°C 90°C 60°C  
*ambient temperature:* 60°C 25°C 60°C  
*duty cycle:* 40% 100% 100%



|   |                                  |
|---|----------------------------------|
| <b>GEV No.</b> 372025   | <b>Ref. No.</b> 12003285 Z611124 |
| <b>description</b> solenoid valve triple straight 230VAC inlet 3/4" outlet 11.5mm DN10 EATON (INVENSYS) |                                  |
| <b>For models:</b> AD-15D, AD-21D, LVC-15D, LVC-21D, LVR-14D, LVR-20D                                   |                                  |

with coded terminal

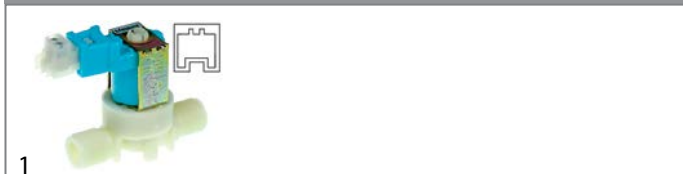

|   |                                     |
|---|-------------------------------------|
| <b>GEV No.</b> 370270   | <b>Ref. No.</b> 12029780 RT30020343 |
| <b>description</b> solenoid valve single straight 230VAC inlet 3/8" outlet 3/8" DN10 Invensys |                                     |











Зип-Общепит

vsezip.ru

+7(812)987-08-81

| RPE   |  |          |            |
|---|--|----------|------------|
| solenoid valves with reducers   |  |          |            |
| single  |  |          |            |
|  |  |          |            |
| 1   |  |          |            |
| GEV No.   | 370440   | Ref. No. | BR00010368 |
| description   | solenoid valve 1-fold, without membrane (constantly open) angled inlet 3/4" outlet 11.5mm input 10-12l/min RPE plastic flow regulating valve inlet white |          |            |

| TP  |   |          |   |
|---|---|----------|---|
|    |   |          |   |
| 1   |   |          |   |
| GEV No.   | 370021  | Ref. No. | 12023794<br>12032085<br>EU929172<br>P255001 |
| description   | solenoid valve double straight 230VAC inlet 3/4" outlet 11.5mm DN10 TP flow regulating valve inlet white  |          |   |
| For models:   | ACE-061, ACE-101, ACE-102, ACE-201, ACE-202, ACG-061, ACG-101, ACG-102, ACG-201, ACG-202, AD-15, AD-20C-UK, AD-21, AD-21B, AD-21BDD, AD-21C, AD-21DD, AD-21W, AD-48D, AD-64D, AE-061, AE-101, AE-102, AE-201, AE-202, AG-061, AG-101, AG-102, AG-201, AG-202, COE-061, COE-101, COE-102, COE-201, COE-202, CPE9-05, CPE9-05AD, CPE9-05AD-S, CPE9-05NC, CPE9-05PLUS, CPE9-05PLUS-S, CPE9-05S, CPE9-05SNC, CPG9-05, CPG9-05AD, CPG9-05AD-S, CPG9-05NC, CPG9-05PLUS, CPG9-05PLUS-S, CPG9-05S...(Other models you can see in the webshop) |          |   |
| spare parts for   | 370021  |          |   |
|  | GEV No.   | 371013   | Ref. No. —                                  |
| solenoid coil TP 230VAC 50/60Hz   |   |          |   |
| accessories for   | 370021  |          |   |
|  | GEV No.   | 371220   | Ref. No. —                                  |
| reducer TP flow rate 3l/min red tolerance ±15%                                      |   |          |   |
|  | GEV No.   | 371221   | Ref. No. —                                  |
| reducer TP flow rate 5.5l/min yellow tolerance ±15%                                 |   |          |   |
|  | GEV No.   | 371222   | Ref. No. —                                  |
| reducer TP flow rate 6l/min grey tolerance ±15%                                     |   |          |   |
|  | GEV No.   | 371223   | Ref. No. —                                  |
| reducer TP flow rate 10l/min white tolerance ±15%                                   |   |          |   |
|  | GEV No.   | 371224   | Ref. No. —                                  |
| reducer TP flow rate 12l/min bronze tolerance ±15%                                  |   |          |   |
|  | GEV No.   | 371225   | Ref. No. —                                  |
| reducer TP flow rate 16l/min light brown tolerance ±15%                             |   |          |   |
|  | GEV No.   | 371226   | Ref. No. —                                  |
| reducer TP flow rate 20l/min red tolerance ±15%                                     |   |          |   |

|   |         |        |          |                     |
|---|---------|--------|----------|---------------------|
|    | GEV No. | 371230 | Ref. No. | —                   |
| reducer TP flow rate 0.25l/min red tolerance ±25%                                   |         |        |          |                     |
|    | GEV No. | 371231 | Ref. No. | —                   |
| reducer TP flow rate 0.3 l/min violet tolerance ±25%                                |         |        |          |                     |
|    | GEV No. | 371232 | Ref. No. | —                   |
| reducer TP flow rate 0.5l/min orange tolerance ±25%                                 |         |        |          |                     |
|    | GEV No. | 371233 | Ref. No. | —                   |
| reducer TP flow rate 0.8l/min white tolerance ±25%                                  |         |        |          |                     |
|    | GEV No. | 371234 | Ref. No. | 12025263<br>P305013 |
| reducer TP flow rate 1l/min light blue tolerance ±25%                               |         |        |          |                     |
|    | GEV No. | 371235 | Ref. No. | —                   |
| reducer TP flow rate 1.2l/min brown tolerance ±25%                                  |         |        |          |                     |
|    | GEV No. | 371236 | Ref. No. | —                   |
| reducer TP flow rate 1.5l/min light brown tolerance ±25%                            |         |        |          |                     |
|    | GEV No. | 371237 | Ref. No. | —                   |
| reducer TP flow rate 2.5l/min yellow tolerance ±25%                                 |         |        |          |                     |
|    | GEV No. | 371238 | Ref. No. | —                   |
| reducer TP flow rate 3.4l/min dark green tolerance ±25%                             |         |        |          |                     |
|   | GEV No. | 371239 | Ref. No. | —                   |
| reducer TP flow rate 5l/min black tolerance ±25%                                    |         |        |          |                     |
|  | GEV No. | 371240 | Ref. No. | —                   |
| reducer TP flow rate 8l/min blue tolerance ±20%                                     |         |        |          |                     |



|  |  |          |                     |
|---|--|----------|---------------------|
| 1   |  |          |                     |
| GEV No.   | 370017   | Ref. No. | 12025161<br>Z701135 |
| description   | solenoid valve single straight 230VAC inlet 3/4" outlet 11.5mm DN10 TP p max 10bar   |          |                     |
| For models:   | ACE-061, ACE-101, ACE-102, ACE-201, ACE-202, ACG-061, ACG-101, ACG-102, ACG-201, ACG-202, AD-120, AD-120B, AD-120BTTDD-UK, AD-120C, AD-120HY, AD-45BBT, AD-48, AD-48B, AD-48BDD, AD-48C, AD-48DD, AD-48HY, AD-48W, AD-64, AD-64B, AD-64BBT, AD-64BDD, AD-64BTDD, AD-64C, AD-64CW, AD-64D, AD-64DD, AD-64HY, AD-72, AD-72W, AD-90, AD-90BA, AD-90BBT, AD-90BDD, AD-90DD, AE-061, AE-061W, AE-101, AE-101W, AE-102, AE-102W, AE-201, AE-202, AG-061, AG-061W...(Other models you can see in the webshop) |          |                     |
| spare parts for   | 370017   |          |                     |
|  | GEV No.  | 371013   | Ref. No. —          |
| solenoid coil TP 230VAC 50/60Hz   |  |          |                     |
| accessories for   | 370017   |          |                     |
|  | GEV No.  | 371220   | Ref. No. —          |
| reducer TP flow rate 3l/min red tolerance ±15%                                      |  |          |                     |

Table continues overleaf



Зип Общепит

vsezip.ru

+7(812)987-08-81

| accessories for 370017 |  | GEV No. | 371221 | Ref. No. | —                   |
|------------------------|--|---------|--------|----------|---------------------|
|                        | reducer TP flow rate 5.5l/min yellow tolerance ±15%      | GEV No. | 371222 | Ref. No. | —                   |
|                        | reducer TP flow rate 6l/min grey tolerance ±15%          | GEV No. | 371223 | Ref. No. | —                   |
|                        | reducer TP flow rate 10l/min white tolerance ±15%        | GEV No. | 371224 | Ref. No. | —                   |
|                        | reducer TP flow rate 12l/min bronze tolerance ±15%       | GEV No. | 371225 | Ref. No. | —                   |
|                        | reducer TP flow rate 16l/min light brown tolerance ±15%  | GEV No. | 371226 | Ref. No. | —                   |
|                        | reducer TP flow rate 20l/min red tolerance ±15%          | GEV No. | 371230 | Ref. No. | —                   |
|                        | reducer TP flow rate 0.25l/min red tolerance ±25%        | GEV No. | 371231 | Ref. No. | —                   |
|                        | reducer TP flow rate 0.35l/min violet tolerance ±25%     | GEV No. | 371232 | Ref. No. | —                   |
|                        | reducer TP flow rate 0.5l/min orange tolerance ±25%      | GEV No. | 371233 | Ref. No. | —                   |
|                        | reducer TP flow rate 0.8l/min white tolerance ±25%       | GEV No. | 371234 | Ref. No. | 12025263<br>P305013 |
|                        | reducer TP flow rate 1l/min light blue tolerance ±25%    | GEV No. | 371235 | Ref. No. | —                   |
|                        | reducer TP flow rate 1.2l/min brown tolerance ±25%       | GEV No. | 371236 | Ref. No. | —                   |
|                        | reducer TP flow rate 1.5l/min light brown tolerance ±25% | GEV No. | 371237 | Ref. No. | —                   |
|                        | reducer TP flow rate 2.5l/min yellow tolerance ±25%      | GEV No. | 371238 | Ref. No. | —                   |
|                        | reducer TP flow rate 3.4l/min dark green tolerance ±25%  | GEV No. | 371239 | Ref. No. | —                   |
|                        | reducer TP flow rate 5l/min black tolerance ±25%         | GEV No. | 371240 | Ref. No. | —                   |
|                        | reducer TP flow rate 8l/min blue tolerance ±20%          |         |        |          |                     |

| GEV No.                | 370018   | Ref. No. | 12034078 |
|------------------------|--|----------|----------|
| <b>description</b>     | solenoid valve single straight 230VAC inlet 3/4" outlet 14mm DN10 TP |          |          |
| <b>spare parts for</b> | 370018   |          |          |
|                        | GEV No.  | 371013   | Ref. No. |
|                        | solenoid coil TP 230VAC 50/60Hz                                      |          |          |
| <b>accessories for</b> | 370018   |          |          |
|                        | GEV No.  | 371220   | Ref. No. |
|                        | reducer TP flow rate 3l/min red tolerance ±15%                       |          |          |
|                        | GEV No.  | 371221   | Ref. No. |
|                        | reducer TP flow rate 5.5l/min yellow tolerance ±15%                  |          |          |
|                        | GEV No.  | 371222   | Ref. No. |
|                        | reducer TP flow rate 6l/min grey tolerance ±15%                      |          |          |
|                        | GEV No.  | 371223   | Ref. No. |
|                        | reducer TP flow rate 10l/min white tolerance ±15%                    |          |          |
|                        | GEV No.  | 371224   | Ref. No. |
|                        | reducer TP flow rate 12l/min bronze tolerance ±15%                   |          |          |
|                        | GEV No.  | 371225   | Ref. No. |
|                        | reducer TP flow rate 16l/min light brown tolerance ±15%              |          |          |
|                        | GEV No.  | 371226   | Ref. No. |
|                        | reducer TP flow rate 20l/min red tolerance ±15%                      |          |          |
|                        | GEV No.  | 371230   | Ref. No. |
|                        | reducer TP flow rate 0.25l/min red tolerance ±25%                    |          |          |
|                        | GEV No.  | 371231   | Ref. No. |
|                        | reducer TP flow rate 0.35l/min violet tolerance ±25%                 |          |          |
|                        | GEV No.  | 371232   | Ref. No. |
|                        | reducer TP flow rate 0.5l/min orange tolerance ±25%                  |          |          |
|                        | GEV No.  | 371233   | Ref. No. |
|                        | reducer TP flow rate 0.8l/min white tolerance ±25%                   |          |          |
|                        | GEV No.  | 371234   | Ref. No. |
|                        | reducer TP flow rate 1l/min light blue tolerance ±25%                |          |          |
|                        | GEV No.  | 371235   | Ref. No. |
|                        | reducer TP flow rate 1.2l/min brown tolerance ±25%                   |          |          |
|                        | GEV No.  | 371236   | Ref. No. |
|                        | reducer TP flow rate 1.5l/min light brown tolerance ±25%             |          |          |
|                        | GEV No.  | 371237   | Ref. No. |
|                        | reducer TP flow rate 2.5l/min yellow tolerance ±25%                  |          |          |

Table continues overleaf

electric components

Зип-Общепит

spare parts and accessories

vsezip.ru

+7(812)987-08-81

1

|                    |   |                 |                     |
|--------------------|---|-----------------|---------------------|
| <b>GEV No.</b>     | 691081  | <b>Ref. No.</b> | 12024509<br>R665041 |
| <b>description</b> | reducer flow rate 0.25l/min green tolerance ±25%  |                 |                     |
| <b>For models:</b> | ACE-061, ACE-101, ACE-102, ACE-201, ACG-061, ACG-101, AE-061, AE-061W, AE-101, AE-101W, AE-102, AE-102W, AE-201, AG-061, AG-061W, AG-101, AG-101W, AG-102, AG-102W, AG-201, AG-202, APE-061, APE-061W, APE-101, APE-101W, APE-102, APE-102W, APE-201, APG-061, APG-061W, APG-101, APG-101W, APG-102, APG-102W, APG-201, APG-202, COE-061, COE-101, COE-201, COG-061, COG-101, HCG-10-11, HCG-10-21, HCG-2-10-11, HCG-6-11, HEI-10-11, HEI-20-11, HEI-6-11, HEM-10-11, HEM-10-21...(Other models you can see in the webshop) |                 |                     |

1



|                    |   |                 |                     |
|--------------------|---|-----------------|---------------------|
| <b>GEV No.</b>     | 691080  | <b>Ref. No.</b> | 12024083<br>P443042 |
| <b>description</b> | reducer flow rate 3l/min light green tolerance ±25%   |                 |                     |
| <b>For models:</b> | COE-061, COE-101, COE-102, COE-201, COE-202, CPE9-05, CPE9-05AD, CPE9-05AD-S, CPE9-05NC, CPE9-05PLUS, CPE9-05PLUS-S, CPE9-05S, CPE9-05SNC, CPG9-05, CPG9-05AD, CPG9-05AD-S, CPG9-05NC, CPG9-05PLUS, CPG9-05PLUS-S, CPG9-05S, CPG9-05SNC, ECO-160, ECO-160D, ECO-160D, ECO-160I, ECO-200, ECO-200D, ECO-200H, ECO-200HD, ECO-200HI, ECO-200I, ECO-2300, ECO-2700D, ECO-2700I, ECO-280D, ECO-280I, ECO-3000, ECO-370D, ECO-370I, ECO-4000D, ECO-4000I, ECO-460D, ECO-460I, ECO-550D, ECO-550I, ECO-6000D, ECO-6000I, FI-160, FI-160D, FI-160D...(Other models you can see in the webshop) |                 |                     |

1

|                    |  |                 |                     |
|--------------------|--|-----------------|---------------------|
| <b>GEV No.</b>     | 691082   | <b>Ref. No.</b> | 12024045<br>Z601156 |
| <b>description</b> | reducer flow rate 8l/min violet tolerance ±25%   |                 |                     |
| <b>For models:</b> | AD-45BBT, AD-48HY, AD-64BBT, AD-64BTDD, AD-64HY, AE-061, AE-101, AE-102, AE-201, AE-202, AG-061, AG-101, AG-102, AG-201, AG-202, APE-061, APE-101, APE-102, APE-201, APE-202, APG-061, APG-101, APG-102, APG-201, APG-202, BME7-05, BME7-10, BMG7-10, CPE9-05, CPE9-05AD, CPE9-05AD-S, CPE9-05NC, CPE9-05PLUS, CPE9-05PLUS-S, CPE9-05S, CPE9-05SNC, CPG9-05, CPG9-05AD, CPG9-05AD-S, CPG9-05NC, CPG9-05PLUS, CPG9-05PLUS-S, CPG9-05S, CPG9-05SNC, ECO-2700D, ECO-2700I, ECO-4000D, ECO-4000I, ECO-550D, ECO-550I...(Other models you can see in the webshop) |                 |                     |

1

|                    |  |                 |                     |
|--------------------|--|-----------------|---------------------|
| <b>GEV No.</b>     | 371234   | <b>Ref. No.</b> | 12025263<br>P305013 |
| <b>description</b> | reducer TP flow rate 1l/min light blue tolerance ±25%  |                 |                     |
| <b>For models:</b> | ACE-061, ACE-101, ACE-102, ACE-201, ACE-202, ACG-061, ACG-101, AD-48D, AD-64D, AE-061, AE-101, AE-102, AE-201, AE-202, AG-061, AG-101, AG-102, AG-201, AG-202, APE-061, APE-101, APE-102, APE-201, APE-202, APG-061, APG-101, APG-102, APG-201, APG-202, COE-202, COE-202, FI-48, FI-48AR, FI-48B, FI-48B-BT-UK, FI-48C, FI-48D, FI-48HY-CLINIC, FI-48W, FI-64, FI-64AR, FI-64B, FI-64B-BT-UK, FI-64C, FI-64D, FI-64HY-CLINIC, FI-64W, HCV-10-11, HCV-5-11, HE-10-11, HE-10-21...(Other models you can see in the webshop) |                 |                     |

|   |   |        |                 |   |
|---|---|--------|-----------------|---|
| <b>accessories for</b>  | 370018  |        |                 |   |
|  | <b>GEV No.</b>  | 371238 | <b>Ref. No.</b> | — |
|   | reducer TP flow rate 3.4l/min dark green tolerance ±25% |        |                 |   |
|  | <b>GEV No.</b>  | 371239 | <b>Ref. No.</b> | — |
|   | reducer TP flow rate 5l/min black tolerance ±25%        |        |                 |   |
|  | <b>GEV No.</b>  | 371240 | <b>Ref. No.</b> | — |
|   | reducer TP flow rate 8l/min blue tolerance ±20%         |        |                 |   |

## solenoid valves with reducers



1

|                    |  |                 |                        |
|--------------------|--|-----------------|------------------------|
| <b>GEV No.</b>     | 370427   | <b>Ref. No.</b> | 12033258<br>BR00023001 |
| <b>description</b> | solenoid valve single angled 230VAC inlet 3/4" outlet 11.5mm input/min output 1.2l/min DN10 t.max. 90°C TP plastic flow regulating valve outlet dark brown |                 |                        |



1

|                    |  |                 |             |
|--------------------|--|-----------------|-------------|
| <b>GEV No.</b>     | 370245   | <b>Ref. No.</b> | EPGC3120530 |
| <b>description</b> | solenoid valve single straight 24VAC inlet 3/4" outlet 11.5mm input 16l/min t.max. 90°C TP plastic flow regulating valve inlet light brown |                 |             |



1

|                    |   |                 |            |
|--------------------|---|-----------------|------------|
| <b>GEV No.</b>     | 370250  | <b>Ref. No.</b> | P443018000 |
| <b>description</b> | solenoid valve triple straight 230VAC inlet 3/4" outlet 11.5mm t.max. 90°C TP plastic output B 0.25l/min flow regulating valve outlet B red |                 |            |





drain valves

Зип Общепит

vsezip.ru

+7(812)987-08-81

|  |   |                 |                       |
|--|---|-----------------|-----------------------|
|  <p>1</p> |   |                 |                       |
| <b>GEV No.</b>   | 401889  | <b>Ref. No.</b> | 12026018<br>RT5400357 |
| <b>description</b>   | drain valve 12V single inlet 40mm outlet 40mm for combi-steamer       |                 |                       |
| <b>accessories for</b>   | 401889  |                 |                       |
|           |   |                 |                       |
| <b>GEV No.</b>   | 532727  | <b>Ref. No.</b> | 12037152<br>RT1000512 |
| <b>description</b>   | O-ring silicone thickness 3.5mm ID ø 26mm Qty 5 pcs for model SCC, CM |                 |                       |
|           |   |                 |                       |
| <b>GEV No.</b>   | 532728  | <b>Ref. No.</b> | 12037113<br>RT1000511 |
| <b>description</b>   | O-ring silicone thickness 3.5mm ID ø 46mm Qty 5 pcs for model SCC, CM |                 |                       |

|  |  |                 |                     |
|--|--|-----------------|---------------------|
|  <p>1</p> |  |                 |                     |
| <b>GEV No.</b>   | 370789   | <b>Ref. No.</b> | 12024781<br>P302120 |
| <b>description</b>   | drain valve 220-240V 50/60Hz NO inlet 50mm outlet 50/35mm MDB-O-2-SO   |                 |                     |
| <b>For models:</b>   | LA-13M, LA-18MP, LA-AC-10M, LA-AC-10MA, LA-AC-10MP, LA-AC-13M, LA-AC-13MA, LA-AC-13MP, LA-AC-18M, LA-AC-18MA, LA-AC-18MP, LAC-10, LAC-10MP, LAC-10MPP, LAC-14, LAC-14MP, LAC-14MPP, LAC-7, LAC-7MP, LAC-7MPP, LA-E-10M, LA-E-10MA, LA-E-10MP, LA-E-13M, LA-E-13MA, LA-E-13MP, LA-E-18M, LA-E-18MA, LA-E-18MP, LA-V-10M, LA-V-10MP, LA-V-13M, LA-V-13MP, LA-V-18M, LA-V-18MP, LB-AC-10M, LB-E-10M, LB-V-10M, LC-10, LC-14, LC-7, LC-AC-10, LC-AC-10A, LC-AC-14, LC-AC-14A, LC-AC-7, LC-AC-7A, LC-E-10, LC-E-10A, LC-E-14... (Other models you can see in the webshop) |                 |                     |

Solenoid valve - accessories

|  |   |                 |                     |
|--|---|-----------------|---------------------|
|  <p>1</p> |   |                 |                     |
| <b>GEV No.</b>   | 500738  | <b>Ref. No.</b> | 12039924<br>R725047 |
| <b>description</b>   | fastening angle for solenoid coil                                     |                 |                     |
| <b>For models:</b>   | HMG-10-11, HMG-10-11UL, HMG-10-21, HMG-10-21UL, HMG-2-10-11, HMG-6-11 |                 |                     |

|                    |  |                 |                       |
|--------------------|--|-----------------|-----------------------|
| <b>GEV No.</b>     | 699812   | <b>Ref. No.</b> | 12036665<br>RT5000086 |
| <b>description</b> | locking plate for solenoid valve L 37mm W 29mm H 4mm |                 |                       |

pressure switches

for warewashing

ø 58mm with male faston 6.3mm

with connection horizontal

|   |   |                 |                     |
|---|---|-----------------|---------------------|
|  <p>1</p> |   |                 |                     |
| <b>GEV No.</b>  | 541137  | <b>Ref. No.</b> | 12025063<br>Z513001 |
| <b>description</b>  | pressure control pressure range 155/40mbar connection 6mm ø 58mm pressure connection horizontal warewashing                                   |                 |                     |
| <b>For models:</b>  | ECO-2700D, ECO-2700I, ECO-4000D, ECO-4000I, ECO-6000D, ECO-6000I, FI-120HY-CLINIC, FI-2700D, FI-2700I, FI-4000D, FI-4000I, FI-6000D, FI-6000I |                 |                     |

|   |  |                 |                     |
|---|--|-----------------|---------------------|
|  <p>1</p> |  |                 |                     |
| <b>GEV No.</b>  | 541776   | <b>Ref. No.</b> | 12023804<br>Z713002 |
| <b>description</b>  | pressure control pressure range 170/95mbar connection 6mm ø 58mm pressure connection horizontal warewashing  |                 |                     |
| <b>For models:</b>  | AD-120, AD-120B, AD-120BTTDD-UK, AD-120C, AD-120CW, AD-120HY, AD-45BBT, AD-48HY, AD-64BBT, AD-64HY, AD-90, AD-90BA, AD-90BBT, AD-90BDD, AD-90DD, ADE-120, ADE-120B, ECO-120, ECO-120B, FI-100, FI-100AR, FI-100B, FI-100BBT-UK, FI-120, FI-120AR+DD, FI-120B, FI-120C, FI-120HY-CLINIC, FI-120W, FI-80, FI-80AR, FI-80BBT-UK, FI-80W, FI-E-100, LABP-1000, LABP-1200, LABP-800, MF-120 |                 |                     |

|   |  |                 |                     |
|---|--|-----------------|---------------------|
|  <p>1</p> |  |                 |                     |
| <b>GEV No.</b>  | 541885   | <b>Ref. No.</b> | 12023855<br>Z273006 |
| <b>description</b>  | pressure control pressure range 205/40mbar connection 6mm ø 58mm pressure connection horizontal pressure connection ø 5.5mm  |                 |                     |
| <b>For models:</b>  | ECO-160, ECO-160D, ECO-160I, ECO-200, ECO-200D, ECO-200H, ECO-200HD, ECO-200HI, ECO-200I, ECO-280D, ECO-280I, ECO-370D, ECO-370I, ECO-460D, ECO-460I, ECO-550D, ECO-550I, FI-160, FI-160AR, FI-160D, FI-160I, FI-200, FI-200AR, FI-200D, FI-200H, FI-200HD, FI-200HI, FI-200I, FI-200W, FI-200WL, FI-200WR, FI-280D, FI-280I, FI-370D, FI-370I, FI-460D, FI-460I, FI-550D, FI-550I |                 |                     |

electric components





Зип Общепит

vsezip.ru

+7(812)987-08-81

|   |   |                 |             |
|---|---|-----------------|-------------|
|  |   |                 |             |
| 1   |   |                 |             |
| <b>GEV No.</b>  | 541683  | <b>Ref. No.</b> | Z273006 011 |
| <b>description</b>  | pressure control pressure range 205/40mbar connection male faston 6.3mm ø 58mm pressure connection horizontal pressure connection ø 6mm |                 |             |

|   |  |                 |                     |
|---|--|-----------------|---------------------|
|  |  |                 |                     |
| 1   |  |                 |                     |
| <b>GEV No.</b>  | 541832   | <b>Ref. No.</b> | 12023856<br>Z713098 |
| <b>description</b>  | pressure control pressure range 24.7/22.2mbar connection 6mm ø 58mm pressure connection horizontal warewashing pressure connection ø 6mm   |                 |                     |
| <b>For models:</b>  | AD-120B, AD-120BTTDD-UK, AD-120C, AD-120HY, AD-90BA, AD-90BBT, AD-90BDD, ADE-120B, ECO-120B, FI-100, FI-100AR, FI-100B, FI-100BBT-UK, FI-120B, FI-120C, FI-120HY-CLINIC, FI-80BBT-UK |                 |                     |

|  |   |                 |                     |
|--|---|-----------------|---------------------|
|  |   |                 |                     |
| 1  |   |                 |                     |
| <b>GEV No.</b>   | 541864  | <b>Ref. No.</b> | 12023803<br>Z403021 |
| <b>description</b>   | pressure control pressure range 28/13mbar connection 6mm ø 58mm pressure connection horizontal warewashing suitable for FAGOR   |                 |                     |
| <b>For models:</b>   | AD-15, AD-15D, AD-21, AD-21B, AD-21C, AD-21D, AD-21DD, CO-350, CO-350-B, CO-350-B-DD, CO-350-COLD, CO-350-COLD-B, CO-350-COLD-B-DD, CO-350-COLD-DD, CO-352-COLD, CO-352-COLD-B, CO-352-COLD-B-DD, CO-352-COLD-DD, CO-400, CO-400-B, CO-400-B-DD, CO-400-COLD, CO-400-COLD-B, CO-400-COLD-B-DD, CO-400-COLD-DD, CO-400-DD, CO-400-SOFT, CO-402-COLD, CO-402-COLD-B, CO-402-COLD-B-DD, CO-402-COLD-DD, ECO-280D, ECO-280I, ECO-370D, ECO-370I, ECO-460D, ECO-460I, ECO-550D, ECO-550I, FI-160AR, FI-160D, FI-160I, FI-200AR, FI-200D, FI-200HD, FI-200HI, FI-200I, FI-200WL, FI-200WR...(Other models you can see in the webshop) |                 |                     |

|   |   |                 |                     |
|---|---|-----------------|---------------------|
|  |   |                 |                     |
| 1   |   |                 |                     |
| <b>GEV No.</b>  | 541302  | <b>Ref. No.</b> | 12023802<br>Z203023 |
| <b>description</b>  | pressure control pressure range 40/15mbar connection 6mm ø 58mm pressure connection horizontal warewashing  |                 |                     |
| <b>For models:</b>  | AD-45BBT, AD-48, AD-48B, AD-48BDD, AD-48C, AD-48D, AD-48DD, AD-48HY, AD-48W, AD-64, AD-64B, AD-64BBT, AD-64BDD, AD-64BTDD, AD-64C, AD-64CW, AD-64D, AD-64DD, AD-64HY, AD-72, AD-72W, EASY-500, EASY-500B, EASY-500DD, EASY-500HP, EASY-500HPWBDD, FI-120HY-CLINIC, FI-30, FI-30AR, FI-30AR+DD, FI-30B, FI-30B-BT-UK, FI-30-UK, FI-48, FI-48AR, FI-48B, FI-48B-BT-UK, FI-48C, FI-48D, FI-48HY-CLINIC, FI-48W, FI-64, FI-64AR, FI-64B, FI-64B-BT-UK, FI-64C, FI-64D, FI-64B-BT-UK, FI-64C, FI-64D, FI-64HY-CLINIC...(Other models you can see in the webshop) |                 |                     |

|  |  |                 |                     |
|--|--|-----------------|---------------------|
|  |  |                 |                     |
| 1  |  |                 |                     |
| <b>GEV No.</b>   | 541593   | <b>Ref. No.</b> | 12023854<br>Z313006 |
| <b>description</b>   | pressure control pressure range 50/35mbar connection 6mm ø 58mm pressure connection horizontal   |                 |                     |
| <b>For models:</b>   | ECO-2700D, ECO-2700I, ECO-280D, ECO-280I, ECO-370D, ECO-370I, ECO-4000D, ECO-4000I, ECO-460D, ECO-460I, ECO-550D, ECO-550I, ECO-6000D, ECO-6000I, FI-2700D, FI-2700I, FI-280D, FI-280I, FI-370D, FI-370I, FI-4000D, FI-4000I, FI-460D, FI-460I, FI-550D, FI-550I, FI-6000D, FI-6000I |                 |                     |

|  |  |                 |                     |
|--|--|-----------------|---------------------|
|  |  |                 |                     |
| 1  |  |                 |                     |
| <b>GEV No.</b>   | 541594   | <b>Ref. No.</b> | 12020076<br>Z683071 |
| <b>description</b>   | pressure control pressure range 85/50mbar connection 6mm ø 58mm pressure connection horizontal pressure connection ø 6mm |                 |                     |
| <b>For models:</b>   | ECO-1200, FI-1200, FI-900  |                 |                     |

|   |  |                 |                     |
|---|--|-----------------|---------------------|
|  |  |                 |                     |
| 1   |  |                 |                     |
| <b>GEV No.</b>  | 541299   | <b>Ref. No.</b> | 12023805<br>Z223005 |
| <b>description</b>  | pressure control pressure range 95/75mbar connection 6mm ø 58mm pressure connection horizontal warewashing pressure connection ø 6mm   |                 |                     |
| <b>For models:</b>  | AD-48B, AD-48BDD, AD-48C, AD-48HY, AD-48W, AD-64B, AD-64BBT, AD-64BDD, AD-64C, AD-64CW, AD-64HY, AD-72W, EASY-500B, EASY-500HPWBDD, FI-30, FI-30AR, FI-30AR+DD, FI-30B, FI-30B-BT-UK, FI-30-UK, FI-48, FI-48AR, FI-48B, FI-48B-BT-UK, FI-48C, FI-48D, FI-48HY-CLINIC, FI-48W, FI-64, FI-64AR, FI-64B, FI-64B-BT-UK, FI-64C, FI-64D, FI-64HY-CLINIC, FI-64W, MF-48, MF-64 |                 |                     |



Зип Общежит

miscellaneous

vsezip.ru

+7(812)987-08-81

ø 84mm with coded plug



|                    |   |                 |                     |
|--------------------|---|-----------------|---------------------|
| <b>GEV No.</b>     | 541296  | <b>Ref. No.</b> | 12024981<br>Z433011 |
| <b>description</b> | pressure control 2 pressure ranges pressure range 28/13 65/50mbar connection 6mm ø 84mm pressure connection horizontal warewashing pressure connection ø 5.5mm  |                 |                     |
| <b>For models:</b> | AD-20C-UK, AD-21B, AD-21BDD, AD-21C, AD-21W, CO-350, CO-350-B, CO-350-B-DD, CO-350-COLD, CO-350-COLD-B, CO-350-COLD-B-DD, CO-350-COLD-DD, CO-350-DD, CO-352-COLD, CO-352-COLD-B, CO-352-COLD-B-DD, CO-352-COLD-DD, CO-400, CO-400-B, CO-400-B-DD, CO-400-COLD, CO-400-COLD-B, CO-400-COLD-B-DD, CO-400-COLD-DD, CO-400-DD, CO-400-SOFT, CO-402-COLD, CO-402-COLD-B, CO-402-COLD-B-DD, CO-402-COLD-DD, CO-402W, LVC-21B, LVC-21C, LVC-21W, MF-21 |                 |                     |

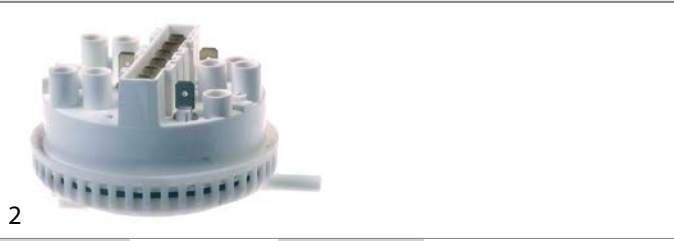

|                    |  |                 |                     |
|--------------------|--|-----------------|---------------------|
| <b>GEV No.</b>     | 541592   | <b>Ref. No.</b> | 12024269<br>Z213059 |
| <b>description</b> | pressure control 3 pressure ranges pressure range 40/15 120/60 150/95mbar connection 6mm ø 84mm pressure connection ø 6mm  |                 |                     |
| <b>For models:</b> | AD-120BTTDD-UK, AD-120HY, AD-45BBT, AD-48HY, AD-64BBT, AD-64BTDD, AD-64HY, AD-90BA, AD-90BBT, AD-90BDD, EASY-500HPWBDD, FI-100BBT-UK, FI-120HY-CLINIC, FI-30B-BT-UK, FI-48B-BT-UK, FI-48HY-CLINIC, FI-64B-BT-UK, FI-64HY-CLINIC, FI-80BBT-UK |                 |                     |



|                    |  |                 |                     |
|--------------------|--|-----------------|---------------------|
| <b>GEV No.</b>     | 541297   | <b>Ref. No.</b> | 12020019<br>Z103074 |
| <b>description</b> | pressure control pressure range 28/13mbar connection 6mm ø 84mm pressure connection horizontal warewashing suitable for FAGOR pressure connection ø 6mm  |                 |                     |
| <b>For models:</b> | ECO-160, ECO-1600, ECO-200, ECO-200H, ECO-2300, ECO-2700D, ECO-2700I, ECO-280D, ECO-280I, ECO-3000, ECO-370D, ECO-370I, ECO-4000D, ECO-4000I, ECO-460D, ECO-460I, ECO-550D, ECO-550I, ECO-6000D, ECO-6000I, FI-160, FI-1600, FI-160D, FI-160I, FI-200, FI-200D, FI-200H, FI-200HD, FI-200HI, FI-200I, FI-200W, FI-2300, FI-2700D, FI-2700I, FI-280D, FI-280I, FI-3000, FI-370D, FI-370I, FI-4000D, FI-4000I, FI-460D, FI-460I, FI-550D, FI-550I, FI-6000D, FI-6000I, LVC-12, LVC-15, LVC-15D...(Other models you can see in the webshop) |                 |                     |

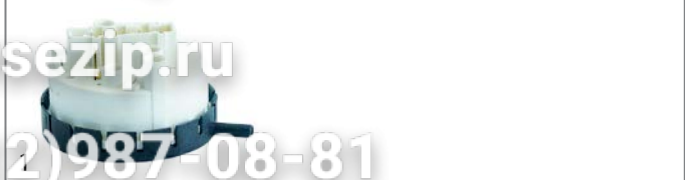

|                    |   |                 |                     |
|--------------------|---|-----------------|---------------------|
| <b>GEV No.</b>     | 541603  | <b>Ref. No.</b> | 12040359<br>Z433003 |
| <b>description</b> | pressure control pressure range 28/13 65/50mbar connection coded plug ø 75mm pressure connection horizontal warewashing pressure connection ø 5.5mm |                 |                     |
| <b>For models:</b> | LVC-21B, LVR-20, LVR-20B  |                 |                     |

accessories



|                    |   |                 |                     |
|--------------------|---|-----------------|---------------------|
| <b>GEV No.</b>     | 541598  | <b>Ref. No.</b> | 12023163<br>Z602923 |
| <b>description</b> | bracket stainless steel H 37mm L 60mm W 12mm for pressure switch  |                 |                     |
| <b>For models:</b> | AD-120, AD-120B, AD-120BTTDD-UK, AD-120C, AD-120CW, AD-120HY, AD-45BBT, AD-48HY, AD-48W, AD-64BBT, AD-64BTDD, AD-64CW, AD-64HY, AD-72W, AD-90, AD-90BA, AD-90BBT, AD-90BDD, AD-90DD, ADE-120, ADE-120B, CO-350, CO-350-B, CO-350-B-DD, CO-350-COLD, CO-350-COLD-B, CO-350-COLD-B-DD, CO-350-COLD-DD, CO-350-DD, CO-352-COLD, CO-352-COLD-B, CO-352-COLD-B-DD, CO-352-COLD-DD, CO-400, CO-400-B, CO-400-B-DD, CO-400-COLD, CO-400-COLD-B, CO-400-COLD-B-DD, CO-400-COLD-DD, CO-400-DD, CO-400-SOFT, CO-402-COLD, CO-402-COLD-B, CO-402-COLD-B-DD, CO-402-COLD-DD, CO-402W, EASY-500, EASY-500B, EASY-500DD...(Other models you can see in the webshop) |                 |                     |



|                    |   |                 |                     |
|--------------------|---|-----------------|---------------------|
| <b>GEV No.</b>     | 541109  | <b>Ref. No.</b> | 12023510<br>Z103077 |
| <b>description</b> | Y-piece plastic hose ø 8-6-8mm for pressure switch  |                 |                     |
| <b>For models:</b> | AD-120B, AD-120BTTDD-UK, AD-120C, AD-120HY, AD-45BBT, AD-48B, AD-48BDD, AD-48C, AD-48HY, AD-48W, AD-64B, AD-64BBT, AD-64BDD, AD-64BTDD, AD-64C, AD-64CW, AD-64HY, AD-72W, AD-90BA, AD-90BBT, AD-90BDD, ADE-120B, CO-500, CO-500B, CO-500BDD, CO-500DD, CO-501, CO-501B, CO-501BDD, CO-501DD, CO-501-SOFT, CO-502B, CO-502BDD, CO-502DD, CO-502W, COP-503, COP-503B, COP-503BDD, COP-503DD, COP-503-SOFT, COP-504, COP-504B, COP-504BDD, COP-504DD, COP-504W, EASY-500B, EASY-500HPWBDD, ECO-120B, ECO-160, ECO-1600...(Other models you can see in the webshop) |                 |                     |

electric components



for gas equipment

Зип-Общепит  
for combi-boilers

1

|                    |                  |                 |                        |
|--------------------|------------------|-----------------|------------------------|
| <b>GEV No.</b>     | 541108           | <b>Ref. No.</b> | 12029376<br>RT30171004 |
| <b>description</b> | pressure control |                 |                        |



1

|                    |  |                 |                     |
|--------------------|--|-----------------|---------------------|
| <b>GEV No.</b>     | 541304   | <b>Ref. No.</b> | 12018227<br>R723004 |
| <b>description</b> | pressure control pressure range 2.7/2.15mbar pressure connection horizontal gas technology connection 6mm      |                 |                     |
| <b>For models:</b> | HCG-10-11, HCG-10-21, HCG-20-11, HCG-2-10-11, HCG-6-11, HMG-10-11, HMG-10-21, HMG-20-11, HMG-2-10-11, HMG-6-11 |                 |                     |



1

|                    |  |                 |                        |
|--------------------|--|-----------------|------------------------|
| <b>GEV No.</b>     | 541111   | <b>Ref. No.</b> | 12030211<br>RT30171010 |
| <b>description</b> | pressure control pressure range adjustable 0.2- 3mbar pressure connection horizontal gas technology connection 6mm suitable for RATIONAL |                 |                        |

for steam control



1

|                    |  |                 |                     |
|--------------------|--|-----------------|---------------------|
| <b>GEV No.</b>     | 541769   | <b>Ref. No.</b> | 12024188<br>S093000 |
| <b>description</b> | pressure control ø 45mm kettle pressure range up to 1.0bar connection 1/4" 250V 8A p max 1bar pressure connection 1/4"   |                 |                     |
| <b>For models:</b> | ME7-10BM, ME9-10BM, ME9-10BMS, ME9-10PLUS-BM, ME9-10PLUS-BMS, ME9-15BM, ME9-15BM316, ME9-15BM-AD, ME9-15BMS, ME9-15PLUS-BM, ME9-15PLUS-BMS, MG9-10BMAD, MG9-10BMSAD, MG9-10PLUS-BM, MG9-10PLUS-BMS, MG9-15BMAD, MG9-15BMSAD, MG9-15PLUS-BM, MG9-15PLUS-BMS, MPE9-10BM, MPE9-10BMS, MPE9-15BM, MPE9-15BMS |                 |                     |



1

|                    |   |                 |                        |
|--------------------|---|-----------------|------------------------|
| <b>GEV No.</b>     | 345709  | <b>Ref. No.</b> | 12027847<br>RT30171011 |
| <b>description</b> | pressure control ø 84mm pressure range 0-3mbar for humidity measuring connection 6mm p max 0.025bar pressure connection 6mm |                 |                        |



1

|                    |  |                 |                        |
|--------------------|--|-----------------|------------------------|
| <b>GEV No.</b>     | 345218   | <b>Ref. No.</b> | 12026621<br>RT30171002 |
| <b>description</b> | pressure control pressure range 0-3mbar connection 6mm pressure connection 6mm |                 |                        |

for refrigeration

SAGI NO MIYA



1

|                    |  |                 |  |
|--------------------|--|-----------------|--|
| <b>GEV No.</b>     | 541479   | <b>Ref. No.</b> | 12030110<br>12031100<br>BR00023117<br>BR00023175 |
| <b>description</b> | pressure control HD reset automatic refrigeration type HTB-X114 connection 2.4mm |                 |  |

miscellaneous



1

|                    |   |                 |        |
|--------------------|---|-----------------|--------|
| <b>GEV No.</b>     | 542434  | <b>Ref. No.</b> | 507476 |
| <b>description</b> | pressure control switch-off pressure 16bar switch-on pressure 18bar reset automatic type NSDHF10A00101 refrigeration -30 up to +85°C pressure connection soldering connection 6.35mm connection male faston 6.3mm |                 |        |







Зип Общепит



electrodes

|  |   |                 |                     |
|--|---|-----------------|---------------------|
|  <p>1</p> |   |                 |                     |
| <b>GEV No.</b>   | 694804  | <b>Ref. No.</b> | 12024460<br>R345060 |
| <b>description</b>   | duct for level electrode screw mounting total length 49mm plastic ø 8mm   |                 |                     |
| <b>For models:</b>   | ACE-061, ACE-102, AE-061, AE-061W, AE-101, AE-101W, AE-102, AE-102W, AE-201, AE-202, AG-061, AG-061W, AG-101, AG-101W, AG-102, AG-102W, AG-201, AG-202, APE-061, APE-061W, APE-101, APE-101W, APE-102, APE-102W, APE-201, APE-202, APG-061, APG-061W, APG-101, APG-101W, APG-102, APG-102W, APG-201, APG-202, GA-20, GA-20D, GA-40, GA-40D, ME9-10PLUS-BM, ME9-10PLUS-BMS, ME9-15BM-AD, ME9-15PLUS-BM, ME9-15PLUS-BMS, MG9-10BMAD, MG9-10BMSAD, MG9-10PLUS-BM, MG9-10PLUS-BMS, MG9-15BMAD, MG9-15BMSAD, MG9-15PLUS-BM...(Other models you can see in the webshop) |                 |                     |

|  |  |                 |                        |
|--|--|-----------------|------------------------|
|  <p>2</p> |  |                 |                        |
| <b>GEV No.</b>   | 400163   | <b>Ref. No.</b> | 12038015<br>RT30020409 |
| <b>description</b>   | level electrode PG9 total length 100mm probe L 72/43/22mm insulated probe length 70/62/52mm with 3 probes connection grip connection |                 |                        |

|   |   |                 |                       |
|---|---|-----------------|-----------------------|
|  <p>1</p> |   |                 |                       |
| <b>GEV No.</b>  | 403138  | <b>Ref. No.</b> | 12130422<br>RT8701220 |
| <b>description</b>  | level electrode PG9 total length 100mm probe L 85mm insulated probe length 70mm with connection cable connection coded plug |                 |                       |

|  |  |                 |                        |
|--|--|-----------------|------------------------|
|  <p>1</p> |  |                 |                        |
| <b>GEV No.</b>   | 400021   | <b>Ref. No.</b> | 12032499<br>RT30020401 |
| <b>description</b>   | level electrode PG9 total length 110mm probe L 70/47/24mm insulated probe length 62/38/16mm with 3 probes connection grip connection |                 |                        |

|  |  |                 |                        |
|--|--|-----------------|------------------------|
|  <p>1</p> |  |                 |                        |
| <b>GEV No.</b>   | 400022   | <b>Ref. No.</b> | 12031231<br>RT30020402 |
| <b>description</b>   | level electrode PG9 total length 135mm probe L 89/59/28mm insulated probe length 80mm with 3 probes connection grip connection                           |                 |                        |
| <b>accessories for</b>   | 400022   |                 |                        |
|  | <b>GEV No.</b>   | <b>Ref. No.</b> | —                      |
|  |  connection cable L 1230mm 4-pole for level electrode plug type coded |                 |                        |

|                        |   |                |        |                 |   |
|------------------------|---|----------------|--------|-----------------|---|
| <b>accessories for</b> | 400022  | <b>GEV No.</b> | 550574 | <b>Ref. No.</b> | — |
|                        |  nut thread PG9 H 3mm WS 28 nickel-plated brass Qty 1 pcs mounting mm variable ømm |                |        |                 |   |

|   |   |                 |                     |  |  |
|---|---|-----------------|---------------------|--|--|
|  <p>1</p> |   |                 |                     |  |  |
| <b>GEV No.</b>  | 400884  | <b>Ref. No.</b> | 12023573<br>R345060 |  |  |
| <b>description</b>  | level electrode push-in total length 105mm probe L 95mm insulated probe lengthmm connection M4  |                 |                     |  |  |
| <b>For models:</b>  | ACE-061, ACE-102, AE-061, AE-061W, AE-101, AE-101W, AE-102, AE-102W, AE-201, AE-202, AG-061, AG-061W, AG-101, AG-101W, AG-102, AG-102W, AG-201, AG-202, APE-061, APE-061W, APE-101, APE-101W, APE-102, APE-102W, APE-201, APE-202, APG-061, APG-061W, APG-101, APG-101W, APG-102, APG-102W, APG-201, APG-202, GA-20, GA-20D, GA-40, GA-40D, HCV-10-11, HCV-10-21, HCV-2-10-21, HCV-5-11, HCV-6-11, HEM-10-11, HEM-10-21, HEM-20-11, HEM-20-21, HEM-6-11, HEP-10-11, HEP-10-21...(Other models you can see in the webshop) |                 |                     |  |  |

|   |   |                 |                     |  |  |
|---|---|-----------------|---------------------|--|--|
|  <p>1</p> |   |                 |                     |  |  |
| <b>GEV No.</b>  | 400885  | <b>Ref. No.</b> | 12023574<br>R345063 |  |  |
| <b>description</b>  | level electrode push-in total length 120mm probe L 110mm insulated probe lengthmm connection M4   |                 |                     |  |  |
| <b>For models:</b>  | ACE-061, ACE-102, AE-061, AE-061W, AE-101, AE-101W, AE-102, AE-102W, AE-201, AE-202, AG-061, AG-061W, AG-101, AG-101W, AG-102, AG-102W, AG-201, AG-202, APE-061, APE-061W, APE-101, APE-101W, APE-102, APE-102W, APE-201, APE-202, APG-061, APG-061W, APG-101, APG-101W, APG-102, APG-102W, APG-201, APG-202, GA-20, GA-20D, GA-40, GA-40D, HCV-10-11, HCV-10-21, HCV-2-10-21, HCV-5-11, HCV-6-11, HEM-10-11, HEM-10-21, HEM-20-11, HEM-20-21, HEM-6-11, HEP-10-11, HEP-10-21...(Other models you can see in the webshop) |                 |                     |  |  |

|   |   |                 |                     |  |  |
|---|---|-----------------|---------------------|--|--|
|  <p>1</p> |   |                 |                     |  |  |
| <b>GEV No.</b>  | 400886  | <b>Ref. No.</b> | 12023575<br>R345064 |  |  |
| <b>description</b>  | level electrode push-in total length 130mm probe L 120mm insulated probe lengthmm connection M4   |                 |                     |  |  |
| <b>For models:</b>  | ACE-061, ACE-102, AE-061, AE-061W, AE-101, AE-101W, AE-102, AE-102W, AE-201, AE-202, AG-061, AG-061W, AG-101, AG-101W, AG-102, AG-102W, AG-201, AG-202, APE-061, APE-061W, APE-101, APE-101W, APE-102, APE-102W, APE-201, APE-202, APG-061, APG-061W, APG-101, APG-101W, APG-102, APG-102W, APG-201, APG-202, GA-20, GA-20D, GA-40, GA-40D, HCV-10-11, HCV-10-21, HCV-2-10-21, HCV-5-11, HCV-6-11, HEM-10-11, HEM-10-21, HEM-20-11, HEM-20-21, HEM-6-11, HEP-10-11, HEP-10-21...(Other models you can see in the webshop) |                 |                     |  |  |

|   |   |                 |                       |  |  |
|---|---|-----------------|-----------------------|--|--|
|  <p>1</p> |   |                 |                       |  |  |
| <b>GEV No.</b>  | 403804  | <b>Ref. No.</b> | 12031074<br>RT4400287 |  |  |
| <b>description</b>  | level electrode with cable M15x1.5 probe L 12mm total length 325mm insulated probe length 114mm straight connection plug-in connection ø 1.5mm EPDM |                 |                       |  |  |

electric components

flow meters and flow sensors

ЗипОбщепит

flow sensors



|                    |  |                 |   |
|--------------------|--|-----------------|---|
| 1                  |  |                 |   |
| <b>GEV No.</b>     | 402256   | <b>Ref. No.</b> | 12028357<br>12028358<br>RT30171050<br>RT4400211 |
| <b>description</b> | flow sensor inlet ø 10mm outlet ø 10mm L 110mm flow rate 1-25l/min |                 |   |

R134A  
HMBP monophase

High/Medium evaporation temperature above -20/-15 °C



|   |   |                 |  |
|---|---|-----------------|--|
| 1   |   |                 |  |
| <b>GEV No.</b>  | 605088  | <b>Ref. No.</b> | 12027501<br>12029101<br>12048631<br>2040900039<br>6001700003<br>6021010004 |
| <b>description</b>  | compressor coolant R134a type FR7.5G 220-240V 50Hz HMBP fully hermetic 10.6kg 1/5HP power input 175W cylinder capacity 6.93cm <sup>3</sup> RSIR/CSIR H 196mm 62W 99W 142W 193W 254W 325W 408W 505W 618W test method ASHRAEW   |                 |  |
| <b>For models:</b>  | AF-702-P, BFP-150, BFP-150A, BFP-150I, CFMP-150, CFMP-150F, CFMP-150PC, CFMP-150TV, CMFP-135, CMFP-135-B, CMFP-135-B2, CMFP-135-BP, CMFP-135F, CMFP-135-GR, CMFP-135HD, CMFP-135HH, CMFP-135PC, CMMZ-150, CMMZ-180-7, CMMZ-202, CMPP-150, CMPP-150-C, ERM-250, FMP-150, FMP-150-TV, FMP-202, FMP-255, FMP-307, MCP-135, MCP-135-AD, MCP-135-GN, MCP-180-AD, MEP-100, MEP-100G, MFP-135, MFP-135-2C, MFP-135-2C-GN, MFP-135-4C, MFP-135-4C-GN, MFP-135-AD, MFP-135-AD-2C, MFP-135-AD-4C, MFP-135-AD-PC, MFP-135-B, MFP-135-B2-GN, MFP-135-B-GN, MFP-135-BP-GN, MFP-135-F, MFP-135-F-GN, MFP-135-GN...(Other models you can see in the webshop) |                 |  |
| <b>spare parts for</b>  | 605088  |                 |  |
|  | <b>GEV No.</b>  | 381529          | <b>Ref. No.</b> —  |
| start relay DANFOSS 117U6001  |   |                 |  |

cooling aggregates

|                    |           |                 |        |
|--------------------|-----------|-----------------|--------|
| <b>GEV No.</b>     | 379304*** | <b>Ref. No.</b> | 123456 |
| <b>description</b> |           |                 |        |
| <b>For models:</b> |           |                 |        |

|                    |           |                 |        |
|--------------------|-----------|-----------------|--------|
| <b>GEV No.</b>     | 379304*** | <b>Ref. No.</b> | 123456 |
| <b>description</b> |           |                 |        |
| <b>For models:</b> |           |                 |        |

compressors

EMBRACO / ASPERA

R404a/R507

LBP monophase

Lower evaporation temperature below -20°C



|                    |  |                 |            |
|--------------------|--|-----------------|------------|
| 1                  |  |                 |            |
| <b>GEV No.</b>     | 605174   | <b>Ref. No.</b> | 6021010006 |
| <b>description</b> | compressor coolant R404a/R507 type NJ2192GK 220-240V 50Hz LBP 20.4kg 1 1/4HP cylinder capacity 26.2cm <sup>3</sup> CSR H 265mm 685W 989W 1342W 1745W 2196W 2196WWWWW |                 |            |

Зип Общепит

vsezip.ru

+7(812)987-08-81



|                    |  |                 |  |  |
|--------------------|--|-----------------|--|--|
| <b>1</b>           |  |                 |  | 12027431<br>12028976<br>6001700004<br>6021010007 |
| <b>GEV No.</b>     | 605091   | <b>Ref. No.</b> |  |  |
| <b>description</b> | compressor coolant R134a type FR8.5G 220-240V 50Hz HMBP 10.6kg 1/4HP power input 261W cylinder capacity 7.95cm <sup>3</sup> RSIR/CSIR H 196mm 85W 123W 171W 228W 298W 381W 478W 592W 722WW   |                 |  |  |
| <b>For models:</b> | AEP-701, AEP-702, AEP-801, AEP-802, AF-1402-MIX, AF-1602-MIX, AF-1603-C, AF-1603-P, AF-1604-C, AF-1604-P, AF-702-C, AF-702-P, AFP-1402-MIX, AFP-1602, AFP-1602-2, AFP-1603, AFP-1603-2, AFP-701, AFP-701-FORZ, AFP-702, AFP-702-C, AFP-702-FORZ, AFP-702-P, AFP-801, AFP-802, AFP-802-2C, AFP-802-3C, BFP-200, BFP-200A, BFP-200I, CAEP-701, CAEP-801, CAEP-802, CAF-1402MIXT, CAF-1602MIX, CAFP-1602-2, CAFP-1603-2, CAFP-701, CAFP-702, CAFP-801, CAFP-802, CAFP-802-2C, CAFP-802-3C, CFMP-202, CFMP-202F, CFMP-202PC, CFMP-202TV, CMFP-180, CMFP-180-B, CMFP-180-B2...(Other models you can see in the webshop) |                 |  |  |



|                        |  |                 |                 |                                      |
|------------------------|--|-----------------|-----------------|--------------------------------------|
| <b>1</b>               |  |                 |                 | 12027766<br>6001700009<br>6021010009 |
| <b>GEV No.</b>         | 605076   | <b>Ref. No.</b> |                 |                                      |
| <b>description</b>     | compressor coolant R134a type SC18G 220-240V 50Hz HMBP fully hermetic 13.7kg 1/2HP power input 495W cylinder capacity 17.7cm <sup>3</sup> CSIR H 219mmW 348W 485W 649W 844W 1074W 1343W 1655W 2014W test method ASHRAE |                 |                 |                                      |
| <b>For models:</b>     | AEP-2103, AF-2104-C, AF-2104-P, AF-2105-C, AF-2105-P, AF-2106-C, AF-2106-P, AFP-2103, AFP-2104, AFP-2104-C, AFP-2104-P, AFP-2105, AFP-2105-C, AFP-2105-P, AFP-2106, AFP-2106-C, AFP-2106-P                             |                 |                 |                                      |
| <b>spare parts for</b> | 605076   |                 |                 |                                      |
|                        | <b>GEV No.</b>   | 380058          | <b>Ref. No.</b> | —                                    |
|                        | start relay DANFOSS 117U6019/F278 HST  |                 |                 |                                      |



|                        |  |                 |                 |  |
|------------------------|--|-----------------|-----------------|--|
| <b>1</b>               |  |                 |                 | 12026937<br>12028366<br>6001700007<br>6021010008                                       |
| <b>GEV No.</b>         | 605087   | <b>Ref. No.</b> |                 |  |
| <b>description</b>     | compressor coolant R134a type SC12G 220-240V 50Hz HMBP fully hermetic 12.6kg 1/3HP power input 470W cylinder capacity 12.9cm <sup>3</sup> RSIR/CSIR H 203mm 140W 216W 312W 430W 574W 746W 951W 1191W 1469W test method ASHRAE 79.6W 1790W  |                 |                 |  |
| <b>For models:</b>     | AEP-1402, AEP-1403, AEP-1404, AEP-1602, AEP-1603, AEP-1604, AF-1403-C, AF-1403-P, AF-1404-C, AF-1404-P, AFP-1402, AFP-1402-FORZ, AFP-1403, AFP-1403-C, AFP-1403-FORZ, AFP-1403-P, AFP-1404, AFP-1404-C, AFP-1404-FORZ, AFP-1404-P, AFP-1404-USMC, AFP-1602, AFP-1602-2, AFP-1603, AFP-1603-2, AFP-1604, AP-701, APP-701, BFP-250, BFP-300, FMP-250, FMP-300, MCP-270-GN, MEP-180, MFP-225-B, MFP-270-B, MFP-270-GN, MPP-255, MPP-255-C, MPP-307, MPP-307-C, MPZ1-200, MSP-200-F, MSP-250, MSP-250-F, MSP-300, VC-14-I, VC-14-M, VC-20-I, VC-20-M...(Other models you can see in the webshop) |                 |                 |  |
| <b>spare parts for</b> | 605087   |                 |                 |  |
|                        | <b>GEV No.</b>   | 380483          | <b>Ref. No.</b> | 12019417<br>12034971<br>12035095<br>12058828<br>6004000003<br>6009990224<br>6021010019 |
|                        | start relay DANFOSS 117U6003 HST   |                 |                 |  |

R404a/R507

LBP monophase

Lower evaporation temperature below -20°C

SECO



|                    |   |                 |  |                        |
|--------------------|---|-----------------|--|------------------------|
| <b>1</b>           |   |                 |  | 12027322<br>6021010002 |
| <b>GEV No.</b>     | 605058  | <b>Ref. No.</b> |  |                        |
| <b>description</b> | compressor coolant R404a/R507 type SC15CL 220-240V 50Hz LBP fully hermetic 13.8kg 1/2HP cylinder capacity 15.28cm <sup>3</sup> CSIR H 219mm 486W 637W 813W 1017W 1251W 1699WWWW test method ASHRAE 175W 358W  |                 |  |                        |
| <b>For models:</b> | ADMEN-180, ADMFN-180, AF-1402-MIX, AF-1602-MIX, AFN-701, AFN-702, AFN-801, AFN-802, ANF-801AD, ANF-802AD, CAF-1402MIXT, CAF-1602MIX, CAFN-701, CAFN-702, CAFN-801, CAFN-802, CMFN-180, CMFN-225, CMFN-270, CMPN-202, CMPN-255, CMSN-200, CMSN-250, CMSN-300, CPAFN-801, MCN-180, MFN-180, MPN-202, MPN-202-C, MSN-200, MSN-250, MSN-300 |                 |  |                        |



## accessories



|                    |   |                 |  |
|--------------------|---|-----------------|--|
| 1                  |   |                 |  |
| <b>GEV No.</b>     | 380483  | <b>Ref. No.</b> | 12019417<br>12034971<br>12035095<br>12058828<br>6004000003<br>6009990224<br>6021010019 |
| <b>description</b> | start relay DANFOSS 117U6003 HST  |                 |  |
| <b>For models:</b> | AEP-1402, AEP-1403, AEP-1404, AEP-1602, AEP-1603, AEP-1604, AF-1403-C, AF-1404-C, AF-702-C, AFP-1402, AFP-1403, AFP-1403-C, AFP-1403-P, AFP-1404, AFP-1404-C, AFP-1404-P, AFP-1404-USMC, AFP-1602, AFP-1602-2, AFP-1603, AFP-1603-2, AFP-1604, AP-701, APP-701, BFP-250, BFP-300, FMP-250, FMP-300, MCP-270-GN, MEP-180, MFP-270-GN, MPP-255, MPP-255-C, MPP-307, MPP-307-C, MPZ1-200, MSP-200-F, MSP-250, MSP-250-F, MSP-300, VC-14-I, VC-14-M, VC-20-I, VC-20-M, VM-100-I, VM-100-M, VM-135-I, VM-135-M |                 |  |



|                    |  |                 |                        |
|--------------------|--|-----------------|------------------------|
| 1                  |  |                 |                        |
| <b>GEV No.</b>     | 380534   | <b>Ref. No.</b> | 12040409<br>6004000006 |
| <b>description</b> | start relay DANFOSS 117U6015/F082 HST  |                 |                        |
| <b>For models:</b> | AFP-2103, AFP-2104, AFP-2104-C, AFP-2104-P, AFP-2105, AFP-2105-C, AFP-2105-P, AFP-2106, AFP-2106-C, AFP-2106-P |                 |                        |



|                    |   |                 |                        |
|--------------------|---|-----------------|------------------------|
| 1                  |   |                 |                        |
| <b>GEV No.</b>     | 380572  | <b>Ref. No.</b> | 12034743<br>6002000031 |
| <b>description</b> | start relay DANFOSS 117U6015/F331 HST   |                 |                        |
| <b>For models:</b> | AEP-701, AEP-702, AEP-801, AEP-802, AFP-1402-MIX, AFP-1602-2, AFP-701, AFP-701-FORZ, AFP-702, AFP-702-C, AFP-702-FORZ, AFP-702-P, AFP-801, AFP-802, BFP-200, FMP-200, MCP-180-GN, MCP-225-GN, MEP-135, MFP-147-GN-R, MFP-180-GN, MFP-192-GN-R, MFP-225-GN, MPP-202, MPP-202-C, MSP-200, MSP-200-F, VM-100-I, VM-100-M |                 |                        |

Зип Общепит

vsezip.ru

+7(812)987-08-81

|                    |   |                 |                                    |
|--------------------|---|-----------------|------------------------------------|
| 1                  |   |                 |                                    |
| <b>GEV No.</b>     | 360484  | <b>Ref. no.</b> | 12034947<br>12058829<br>6021010025 |
| <b>description</b> | start relay DANFOSS 117U6015/F394 HST   |                 |                                    |
| <b>For models:</b> | AEP-701, AEP-801, AEP-802, AF-1402-MIX, AF-1602-MIX, AF-1603-C, AF-1603-P, AF-1604-C, AF-1604-P, AF-702-C, AF-702-P, AFN-701, AFP-1602, AFP-1602-2, AFP-1603, AFP-1603-2, AFP-701, AFP-702, AFP-801, AFP-802, AFP-802-2C, AFP-802-3C, BFP-150, BFP-200, BFP-200A, BFP-200I, CAEP-701, CAEP-801, CAEP-802, CAF-1402MIXT, CAF-1602MIX, CAF-1602-2, CAF-1603-2, CAF-701, CAF-702, CAF-801, CAF-802, CAF-802-2C, CAF-802-3C, CFMP-202, CFMP-202F, CFMP-202PC, CFMP-202TV, CMFP-135-GR, CMFP-180, CMFP-180-B, CMFP-180-B2, CMFP-180-BP, CMFP-180F, CMFP-180-GR...(Other models you can see in the webshop) |                 |                                    |

|                    |  |                 |            |
|--------------------|--|-----------------|------------|
| 1                  |  |                 |            |
| <b>GEV No.</b>     | 380573   | <b>Ref. No.</b> | 6004000004 |
| <b>description</b> | start relay DANFOSS 117U6019/F152 HST  |                 |            |
| <b>For models:</b> | AFN-701, AFN-702, AFN-801, AFN-802, AFP-1402-MIX, MCN-135-GN, MCN-180-GN, MFN-135-GN, MFN-180-GN, MPN-150, MPN-150-C, MSN-150, MSN-200 |                 |            |

## miscellaneous

## accessories



|                    |  |                 |                        |
|--------------------|--|-----------------|------------------------|
| 1                  |  |                 |                        |
| <b>GEV No.</b>     | 381135   | <b>Ref. No.</b> | 12031673<br>6021010050 |
| <b>description</b> | start relay GENERAL ELECTRIC 3ARR3B3AV3 220V connection screw clamp  |                 |                        |
| <b>For models:</b> | AFN-1402, AFN-1403, AFN-1404, AFN-1602, AFN-1603, AFN-1604, ATM-051, ATM-101, MCN-270, MFN-270, MPN-255, MPN-255-C, MPN-307, MPN-307-C |                 |                        |



fans

axial fans

ebm-papst



1

|                    |  |                 |                       |
|--------------------|--|-----------------|-----------------------|
| <b>GEV No.</b>     | 601309 <sup>1</sup>  | <b>Ref. No.</b> | 12027993<br>RT4000474 |
| <b>description</b> | axial fan L 127mm W 127mm H 38mm 12VDC 21W bearing ball bearing manuf. no. DV5212N metal connection cable ebm-papst suitable for RATIONAL fan wheel ø 120mm temp.-resist. 65°C |                 |                       |

<sup>1</sup>with ball bearings

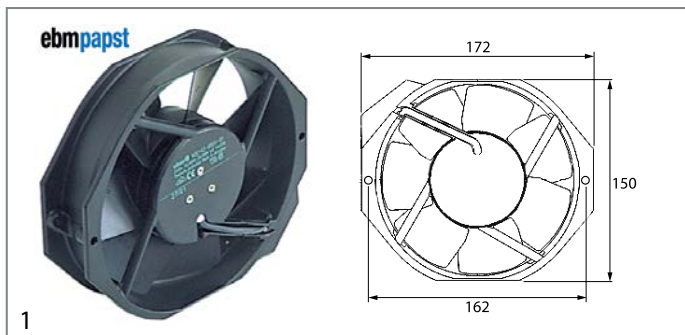

1

|                    |   |                 |                        |
|--------------------|---|-----------------|------------------------|
| <b>GEV No.</b>     | 601113 <sup>1</sup>   | <b>Ref. No.</b> | 12026852<br>RT31011013 |
| <b>description</b> | axial fan L 172mm W 150mm H 38mm 230VAC 50/60Hz 27/28W bearing ball bearing connection male faston 2.8mm manuf. no. 7056ES metal ebm-papst fan wheel ø 145mm temp.-resist. 55°C |                 |                        |

<sup>1</sup>with ball bearings

Зип Общепит

vsezip.ru

+7(812)987-08-81



1



|                    |   |                 |  |
|--------------------|---|-----------------|--|
| <b>GEV No.</b>     | 601510 <sup>1</sup>   | <b>Ref. No.</b> | 12032884<br>12033472<br>6001506003<br>6021050008 |
| <b>description</b> | axial fan L 119mm W 119mm H 38mm 230VAC 50/60Hz 22/21W bearing ball bearing connection male faston 6.3mm SUNON temp.-resist. 70°C   |                 |  |
| <b>For models:</b> | AEP-1402, AEP-701, AFP-1402, AFP-1402-FORZ, AFP-1403, AFP-1403-C, AFP-1403-FORZ, AFP-1403-P, AFP-1404, AFP-1404-C, AFP-1404-P, AFP-2103, AFP-2104, AFP-2104-C, AFP-2104-P, AFP-2105, AFP-2105-C, AFP-2105-P, AFP-2106, AFP-2106-C, AFP-2106-P, AFP-701, AFP-701-FORZ, AFP-702, AFP-702-C, AFP-702-FORZ, AFP-702-P, APP-701, CMPZ1-135, CMPZ1-180, ECE-80, ERM-150, ERM-250, ERM-350, ERMS-250, MEP-100, MEP-100G, MEP-135, MEP-135-GN, MEP-180, MEP-180-GN, MI-202, MPZ1-135, MPZ1-150, MPZ1-180, MPZ1-200, MPZ1-225, MPZ1-250, MPZ1-250, VTP-139-C...(Other models you can see in the webshop) |                 |  |

<sup>1</sup>with ball bearings



1

|                    |  |                 |   |
|--------------------|--|-----------------|---|
| <b>GEV No.</b>     | 601080 <sup>1</sup>  | <b>Ref. No.</b> | 12023862<br>12031028<br>12031777<br>12032776<br>6021050006<br>RT31011008<br>ST25000040<br>Z103066 |
| <b>description</b> | axial fan L 119mm W 119mm H 38mm 230VAC 50/60Hz 23/20W bearing ball bearing connection male faston 2.8mm metal ADDA fan wheel ø 110mm temp.-resist. 70°C   |                 |   |
| <b>For models:</b> | ACE-061, ACE-101, ACE-102, ACG-061, ACG-101, ACG-102, AD-120, AD-120B, AD-120BTTDD-UK, AD-120C, AD-120CW, AD-120HY, AD-90, AD-90BA, AD-90BBT, AD-90BDD, AD-90DD, AE-061, AE-101, AE-102, AG-061, AG-101, AG-102, APE-061, APE-101, APE-102, APG-061, APG-101, APG-102, CI9-20, CI9-40, COE-061, COE-101, COE-102, COE-201, COG-061, COG-101, COG-102, COG-201, ECO-120, ECO-120B, ECO-160, ECO-1600, ECO-160D, ECO-160I, ECO-200, ECO-200D, ECO-200H, ECO-200HD, ECO-200HI...(Other models you can see in the webshop) |                 |   |

|   |  |        |                 |                     |
|---|--|--------|-----------------|---------------------|
| <b>accessories for</b>  | 601080   |        |                 |                     |
|  | <b>GEV No.</b>   | 550898 | <b>Ref. No.</b> | —                   |
|   | connecting cable cable length 2000mm connection F 2.8 connection distance 7.9mm for axial flow fan |        |                 |                     |
|  | <b>GEV No.</b>   | 692519 | <b>Ref. No.</b> | 12025177<br>Z713015 |
|   | guard L 120mm W 120mm plastic  |        |                 |                     |

<sup>1</sup>with ball bearings

electric components

Зип-Общепит

accessories

fan guards

vsezip.ru

+7(812)987-08-81



|                    |  |                 |                        |
|--------------------|--|-----------------|------------------------|
| <b>GEV No.</b>     | 601670 <sup>1</sup>  | <b>Ref. No.</b> | 12031029<br>RT31011018 |
| <b>description</b> | axial fan L 80mm W 80mm H 25mm 12VDC 1.8W bearing ball bearing connection cable 300mm fan wheel ø 75mm |                 |                        |

<sup>1</sup>with ball bearings

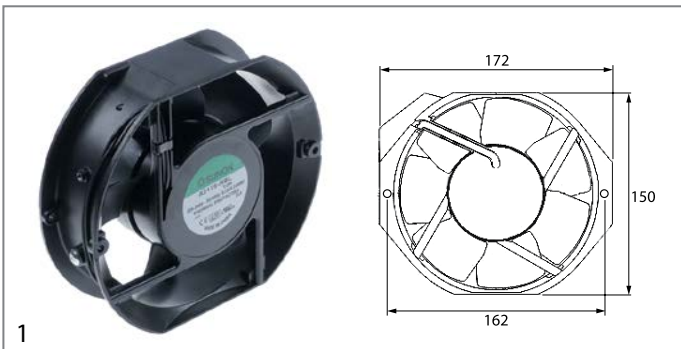

|                    |   |                 |                     |
|--------------------|---|-----------------|---------------------|
| <b>GEV No.</b>     | 601654 <sup>1</sup>   | <b>Ref. No.</b> | 12024106<br>T453005 |
| <b>description</b> | axial fan L 172mm W 150mm H 51mm 230VAC 50/60Hz 28/24W bearing ball bearing manuf. no. A2175-HBL T.GN connection cable length 280mm metal SUNON fan wheel ø 142mm temp.-resist. -10 up to +80°C mounting distance 162mm   |                 |                     |
| <b>For models:</b> | ACE-201, ACE-202, ACG-201, ACG-202, AE-201, AE-202, AG-201, AG-202, APE-201, APE-202, APG-201, APG-202, COE-201, COE-202, COG-201, COG-202, HEI-20-21, HEM-20-21, HEP-20-21, HGC-20-21, HGP-20-21, HGV-20-21, VE-201, VE-202, VG-102, VG-201, VG-202, VPE-201, VPE-202, VPG-102, VPG-201, VPG-202 |                 |                     |

<sup>1</sup>with ball bearings



|                    |  |                 |                     |
|--------------------|--|-----------------|---------------------|
| <b>GEV No.</b>     | 692519   | <b>Ref. No.</b> | 12025177<br>Z713015 |
| <b>description</b> | guard L 120mm W 120mm plastic  |                 |                     |
| <b>For models:</b> | AD-120, AD-120B, AD-120BBTDD-UK, AD-120C, AD-120CW, AD-120HY, AD-90, AD-90BA, AD-90BBT, AD-90BDD, AD-90DD, ADE-120, ADE-120B, ECO-120, ECO-120B, FI-100, FI-100AR, FI-100B, FI-100BBT-UK, FI-120, FI-120AR+DD, FI-120B, FI-120C, FI-120HY-CLINIC, FI-120W, FI-80, FI-80AR, FI-80BBT-UK, FI-80W, FI-E-100, LABP-1000, LABP-1200 |                 |                     |

|  |                |        |                 |   |
|--|----------------|--------|-----------------|---|
| <b>accessories for</b>   | 692519         |        |                 |   |
|   | <b>GEV No.</b> | 601080 | <b>Ref. No.</b> | 12023862<br>12031028<br>12031777<br>12032776<br>6021050006<br>RT31011008<br>ST25000040<br>Z103066 |
| axial fan L 119mm W 119mm H 38mm 230VAC 50/60Hz 23/20W bearing ball bearing connection male faston 2.8mm metal ADDA fan wheel ø 110mm temp.-resist. 70°C |                |        |                 |   |



|                    |  |                 |                        |
|--------------------|--|-----------------|------------------------|
| <b>GEV No.</b>     | 602141   | <b>Ref. No.</b> | 12030835<br>RT84551393 |
| <b>description</b> | guard with filter for axial flow fan L 126mm W 126mm H 13.5mm mounting distance 115mm suitable for ebm-papst |                 |                        |



Зип Общежит  
cooling motors (complete)

vsezip.ru

+7(812)987-08-81

refrigeration fans

refrigeration motors universal

ELCO

N series - standard



1

|   |  |                 |                        |
|---|--|-----------------|------------------------|
| <b>GEV No.</b>  | 601359   | <b>Ref. No.</b> | 12031842<br>6021050055 |
| <b>description</b>  | fan motor 18W 230V 50/60Hz bearing slide bearing W 83mm connection 3-wire cable length 1000mm 1300/1550rpm 3 mounting options VNT18-30/150 |                 |                        |
| <b>spare parts for</b>  | 601359   |                 |                        |
|   | <b>GEV No.</b>   | <b>Ref. No.</b> | —                      |
|  | 601413   |                 |                        |
|   | fixing plate suitable for fanwheel ED ø 32mm shaft ø 7 mounting distance 26mm  |                 |                        |

accessories

fan wheels

plastic



1

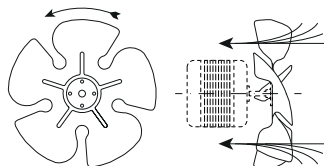

|                    |  |                 |                        |
|--------------------|--|-----------------|------------------------|
| <b>GEV No.</b>     | 601412   | <b>Ref. No.</b> | 12037081<br>BR00010213 |
| <b>description</b> | fan wheel sucking ø 154mm fan wheel mounting 25.4mm blade angle 28° W 34mm plastic |                 |                        |



1

|                    |  |                 |            |
|--------------------|--|-----------------|------------|
| <b>GEV No.</b>     | 601394   | <b>Ref. No.</b> | 6021050004 |
| <b>description</b> | fan 230V 5W 50/60Hz fan wheel ø 200mm shaft L 12mm feet depth 71mm L 60mm W 83mm H 83mm blade angle 28° connection cable 500mm   |                 |            |
| <b>For models:</b> | AF-1403-P, AF-1404-P, AF-1603-P, AF-1604-P, AF-2104-P, AF-2105-P, AF-2106-P, AF-702-C, AF-702-P, AF-802-C, AFP-802, AFP-802-2, EC-150, ECC-150, ERM-250, ERM-350, ERMS-250, VM-100-I, VM-100-M, VM-135-I, VM-135-M, VTP-139-RC, VTP-139-RCD, VTP-139-RP, VTP-139-RPD, VTP-175-RC, VTP-175-RCD, VTP-175-RP, VTP-175-RPD |                 |            |



1

|                    |  |                 |                                      |
|--------------------|--|-----------------|--------------------------------------|
| <b>GEV No.</b>     | 601693   | <b>Ref. No.</b> | 12033477<br>6001506002<br>6021050002 |
| <b>description</b> | fan motor 230V 10W 50/60Hz fan wheel ø 254mm feet depth 85mm W 84mm 1300rpm  |                 |                                      |
| <b>For models:</b> | AEP-1402, AEP-1403, AEP-1404, AEP-1602, AEP-1603, AEP-1604, AEP-2103, AEP-701, AEP-702, AEP-801, AEP-802, AF-1402-MIX, AF-1403-C, AF-1403-P, AF-1404-C, AF-1404-P, AF-1602-MIX, AF-1603-C, AF-1603-P, AF-1604-C, AF-1604-P, AF-2104-C, AF-2104-P, AF-2105-C, AF-2105-P, AF-2106-C, AF-2106-P, AF-702-C, AF-702-P, AF-802-C, AF-802-P, AFN-1402, AFN-1403, AFN-1404, AFN-1602, AFN-1603, AFN-1604, AFN-701, AFN-702, AFN-801, AFN-802, AFP-1402, AFP-1402-FORZ, AFP-1402-MIX, AFP-1403, AFP-1403-C, AFP-1403-FORZ, AFP-1403-P, AFP-1404, AFP-1404-C...(Other models you can see in the webshop) |                 |                                      |

Зип Общепит

vsezip.ru

+7(812)987-08-81



1

|                    |  |                 |  |
|--------------------|--|-----------------|--|
| <b>GEV No.</b>     | 601511   | <b>Ref. No.</b> | 12018609<br>12038161<br>6004000012<br>6021050010 |
| <b>description</b> | fan 230V 10W 50Hz fan wheel ø 195mm blade angle 22° connection cable 500mm   |                 |  |
| <b>For models:</b> | ADAFN-1602, ADMCN-180, ADMCN-225, ADMCP-225, ADMFN-180, ADMFN-225, ADMFP-225, ADMFP-225-GR, ADMFP-225HDDD, ADMFP-225HHDD, ADMFP-225HHHD, ADMFP-225HHHH, ADMFP-225PC, AEP-2103, AF-2104-C, AF-2104-P, AF-2105-C, AF-2105-P, AF-2106-C, AF-2106-P, AFN-1402, AFN-1403, AFN-1404, AFN-1602, AFN-1603, AFN-1604, AFN-801, AFN-802, AFP-2103, AFP-2104, AFP-2105, AFP-2106, ATA-061, ATA-061-60Hz, ATM-051VCH, ATM-051VCH-60Hz, ATM-081VCH, ATM-081VCH-60Hz, ATM-101VCH, ATM-101VCH-60Hz, CPAFN-1602, MCN-192-GN-R, MCN-225-GN, MCN-237-GN-R, MCN-270-GN, MFN-192-GN-R, MFN-225-GN, MFN-237-GN-R, MFN-270-GN, MSN-222-R...(Other models you can see in the webshop) |                 |  |



1

|                    |   |                 |            |
|--------------------|---|-----------------|------------|
| <b>GEV No.</b>     | 601512  | <b>Ref. No.</b> | 6004000011 |
| <b>description</b> | fan 230V 5W 50Hz fan wheel ø 200mm blade angle 28° connection cable 1500mm  |                 |            |
| <b>For models:</b> | AFN-1402, AFN-1403, AFN-1404, AFN-701, AFN-702, AFP-1402-MIX, AP-701, APP-701, MCN-102-GN-R, MCN-135-GN, MCN-147-GN-R, MCN-180-GN, MFN-102-GN-R, MFN-135-GN, MFN-147-GN-R, MFN-180-GN, MSN-117-R, MSN-150, MSN-169-R, MSN-200 |                 |            |

cold air circulating fans (complete)

HIDRIA

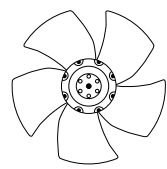
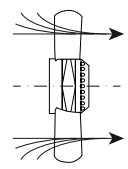
1

|                    |  |                 |                        |
|--------------------|--|-----------------|------------------------|
| <b>GEV No.</b>     | 601811   | <b>Ref. No.</b> | 12026785<br>6021050019 |
| <b>description</b> | fan type R09R-3030HP-4M-2543 fan wheel ø 300mm 230V 50/60Hz 65/90W suitable capacitor 2.5µF HIDRIA suitable for blast chiller suitable for FRIULINOX 1400/1500rpm blowing H 138mm cable lengthmm mounting distance 265mm |                 |                        |
| <b>For models:</b> | ATA-061, ATA-061-60Hz, ATA-101, ATA-101-60Hz, ATM-051, ATM-081VCH, ATM-081VCH-60Hz, ATM-101, ATM-101VCH, ATM-101VCH-60Hz, ATM-121VCH, ATM-121VCH-60Hz, ATM-121VCHP, ATM-161VCH, CM-201, CS-201                           |                 |                        |



2

|                    |  |                 |  |
|--------------------|--|-----------------|--|
| <b>GEV No.</b>     | 601552   | <b>Ref. No.</b> | 12032883<br>12033165<br>6001506001<br>6021050001 |
| <b>description</b> | fan 230V 5W 50/60Hz fan wheel ø 165mm shaft L 15mm blade angle 34° connection cable  |                 |  |
| <b>For models:</b> | AEP-1402, AEP-1403, AEP-1404, AEP-1602, AEP-1603, AEP-1604, AEP-701, AEP-702, AEP-801, AEP-802, AF-1402-MIX, AF-1403-C, AF-1403-P, AF-1404-C, AF-1404-P, AF-1602-MIX, AF-1603-C, AF-1603-P, AF-1604-C, AF-1604-P, AF-702-C, AF-702-P, AF-802-C, AF-802-P, AFP-1402, AFP-1403, AFP-1404, AFP-1404-USMC, AFP-1602, AFP-1602-2, AFP-1603, AFP-1603-2, AFP-1604, AFP-701, AFP-702, AFP-801, AFP-802, AFP-802-2, FMP-117-R, FMP-150, FMP-169-R, FMP-200, FMP-202, FMP-222-R, FMP-250, FMP-255, FMP-274-R, FMP-300, FMP-307, MCN-102-R...(Other models you can see in the webshop) |                 |  |

cross flow fans

ebm-papst



1

|                    |  |                 |                        |
|--------------------|--|-----------------|------------------------|
| <b>GEV No.</b>     | 602084   | <b>Ref. No.</b> | 12031541<br>6021050046 |
| <b>description</b> | cross flow fan ebm-papst RL76/8600Z roller ø 58mm roller length 84mm laminated core thickness 1mm motor position right connection F6.3 W 190mm H 135mm D 135 |                 |                        |







hot air motors



Зип-Общепит

vsezip.ru

+7(812)987-08-81

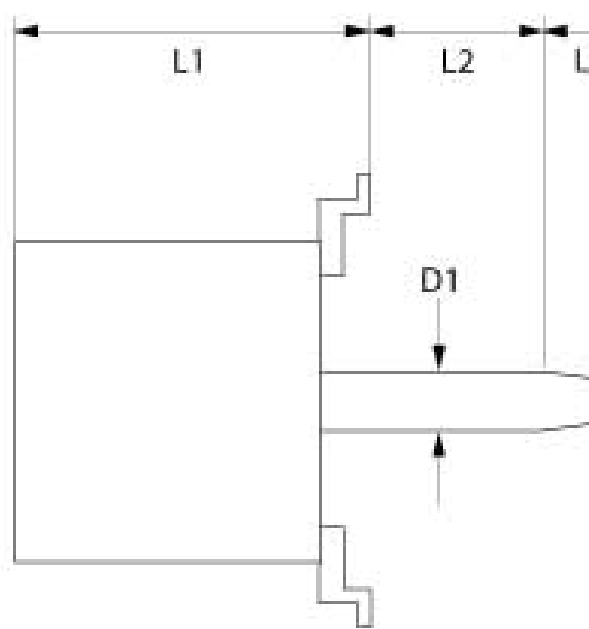
|   |   |                 |                       |
|---|---|-----------------|-----------------------|
|  |   |                 |                       |
| 1   |   |                 |                       |
| <b>GEV No.</b>  | 697780  | <b>Ref. No.</b> | 12032334<br>RT2200083 |
| <b>description</b>  | engine shaft gasket plastic for fan ID $\phi$ 15mm ED $\phi$ 29.5mm thickness 4.5mm |                 |                       |

|  |           |                 |                        |
|--|-----------|-----------------|------------------------|
|  <p>Image not available</p> |           |                 |                        |
| 1  |           |                 |                        |
|                            |           |                 |                        |
| <b>GEV No.</b>   | 601321    | <b>Ref. No.</b> | 12025899<br>RT31001064 |
| <b>description</b>   | fan motor |                 |                        |

|  |  |                 |                        |
|--|--|-----------------|------------------------|
|                   |  |                 |                        |
| 1  |  |                 |                        |
| <b>GEV No.</b>   | 601301   | <b>Ref. No.</b> | 12025570<br>RT4000274P |
| <b>description</b>   | fan motor 100-240V 1 phase 50/60Hz 0.45kW 2000rpm speeds 1 L1 160mm L2mm L3mm L4mm M8R IT fan wheel $\phi$ 130mm type M3G084-FA22-16 |                 |                        |
| <b>accessories for</b>   | 601301   |                 |                        |
|                   | <b>GEV No.</b>   | 511685          | <b>Ref. No.</b> —      |
| shaft seal kit ID $\phi$ 15mm ED $\phi$ 27mm shaft seal flange mounting gauge with mountign material |  |                 |                        |

|                        |   |                 |                                     |
|------------------------|---|-----------------|-------------------------------------|
| <b>accessories for</b> | 601301  |                 |                                     |
| <b>GEV No.</b>         | 601327  | <b>Ref. No.</b> | 12027162<br>22.00.192S<br>RT2200192 |
| <b>description</b>     | fan wheel D1 $\phi$ 340mm H1 135mm blades 9 D2 $\phi$ 13mm D3 $\phi$ 16mm H2 38mm |                 |                                     |

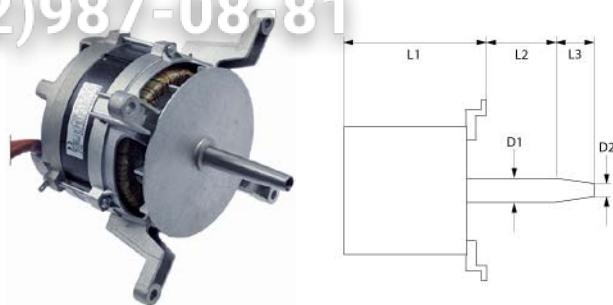
|  |  |  |  |
|--|--|--|--|
|  |  |  |  |
| 1  |  |  |  |

|                    |   |                 |                     |
|--------------------|---|-----------------|---------------------|
| <b>GEV No.</b>     | 601629  | <b>Ref. No.</b> | 12018605<br>T493004 |
| <b>description</b> | fan motor 208/240V 3 phase 50/60Hz 0.66/0.18kW 1400/700rpm speeds 2 L1 150mm L2 40mm L3 35mm D1 $\phi$ 17mm D2 $\phi$ 13.5mm 2.2/0.85A at 50Hz 208/240V at 60Hz 208/240V at 50Hz 1400/700rpm at 60Hz 1700/850rpm type 3036E2470 |                 |                     |
| <b>For models:</b> | HEI-20-21, HEM-10-11, HEM-20-11, HEM-20-21, HEM-6-11, HEP-10-11, HEP-20-11, HEP-6-11, HGC-20-21, HGV-20-21  |                 |                     |

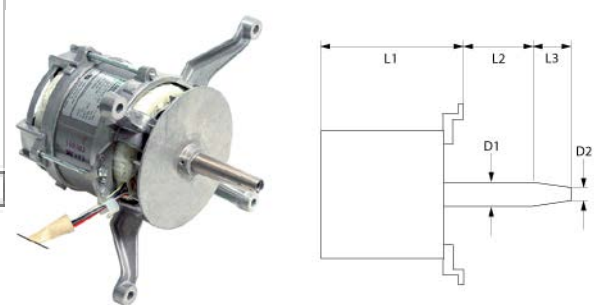
|   |  |  |  |
|---|--|--|--|
|  |  |  |  |
| 1   |  |  |  |

|                    |  |                 |                     |
|--------------------|--|-----------------|---------------------|
| <b>GEV No.</b>     | 500506   | <b>Ref. No.</b> | 12016554<br>R663034 |
| <b>description</b> | fan motor 220-230V 3 phase 50Hz 0.02/0.16kW 710/1390rpm speeds 2 L1 152mm L2 31mm L3 35mm M10R IT 0.35/0.9A power input 60/250W at 50Hz 220-230V at 60Hz 220-230V at 50Hz 710/1390rpm at 60Hz 840/1660rpm Y/YY type L7mw84D-380 no. T7 D1 $\phi$ 17mm D2 $\phi$ 13mm |                 |                     |
| <b>For models:</b> | HME-10-11, HME-10-21, HME-20-11, HME-20-21, HME-2-10-11, HME-2-20-11, HME-6-11, HMP-10-11, HMP-10-21, HMP-20-11, HMP-20-21, HMP-2-10-11, HMP-2-20-11, HMP-6-11   |                 |                     |

electric components

Зип Общепит

vsezip.ru

+7(812)987-08-81

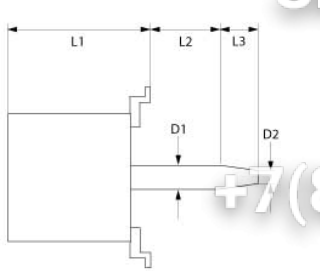
**1**

|   |   |                 |                                     |
|---|---|-----------------|-------------------------------------|
| <b>GEV No.</b>  | 500505  | <b>Ref. No.</b> | 12016565<br>R253049                 |
| <b>description</b>  | fan motor 220-240/380-415V 3 phase 50/60Hz 0.16-0.26kW 1440/1700rpm speeds 2 L1 140mm L2 27mm L3 35mm M10R IT 1.2/0.7A Cos(fi) 0.63 type L7zAw4D-014 D1 ø 17mm D2 ø 13mm  |                 |                                     |
| <b>For models:</b>  | HCG-10-11, HCG-10-21, HCG-20-11, HCG-20-21, HCG-2-10-11, HCG-2-20-11, HCG-6-11, HCV-10-11, HCV-10-21, HCV-2-10-21, HCV-5-11, HCV-6-11, HE-10-11, HE-10-21, HE-2-10-11, HE-5-11, HE-6-11, HG-10-11, HG-10-21, HG-2-10-11, HME-20-11, HMG-10-11, HMG-10-11UL, HMG-10-21, HMG-10-21UL, HMG-20-11, HMG-2-10-11, HMG-6-11, HMI-10-11, HMI-10-11UL, HMI-10-21, HMI-10-21UL, HMI-2-10-11, HMI-6-11, HMI-6-11UL, HMM-10-11, HMM-10-11UL, HMM-10-21, HMM-10-21UL, HMM-20-11, HMM-20-11UL, HMM-20-21, HMM-20-21UL, HMM-2-10-11, HMM-2-20-11, HMM-40-11-USMC, HMM-6-11, HMM-6-11UL, HMP-20-11, HVG-10-11...(Other models you can see in the webshop) |                 |                                     |
| <b>accessories for</b>  | 500505  |                 |                                     |
|  | <b>GEV No.</b>  | 601503          | <b>Ref. No.</b> 12016581<br>R253042 |
|   | fan wheel D1 ø 350mm H1 125mm blades 12 D2 ø 13mm D3 ø 16mm   |                 |                                     |

**1**

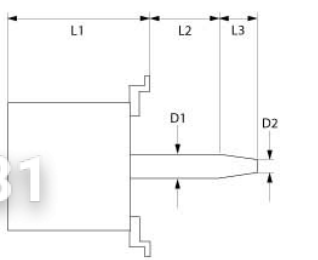
|                    |  |                 |                     |
|--------------------|--|-----------------|---------------------|
| <b>GEV No.</b>     | 601551   | <b>Ref. No.</b> | 12018468<br>R703049 |
| <b>description</b> | fan motor 230-415V 3 phase 50/60Hz 0.65kW 1400/1650rpm speeds 1 L1 147mm L2 41mm L3 36mm M10R IT at 50Hz 1400rpm at 60Hz 1650rpm D1 ø 17mm D2 ø 13.5mm |                 |                     |
| <b>For models:</b> | HEI-10-11, HEI-20-11, HEI-6-11, HGC-10-11, HGC-20-11, HGC-6-11, HGV-10-11, HGV-20-11   |                 |                     |

**1**

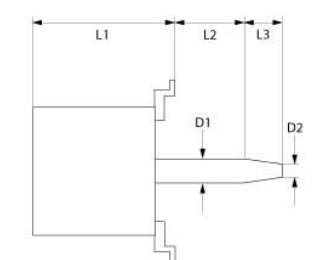
|                    |   |                 |            |
|--------------------|---|-----------------|------------|
| <b>GEV No.</b>     | 601300  | <b>Ref. No.</b> | RT31001080 |
| <b>description</b> | fan motor 240V 3 phase 60Hz 0.68kW 1730rpm speeds 1 L1 145mm L2 24mm L3 34mm M10R IT 2.9A number of pole pairs 2 power input 870W at 60Hz 1730rpm Y type L9DFw4D-518 no. X6 D1 ø 17mm D2 ø 13mm |                 |            |



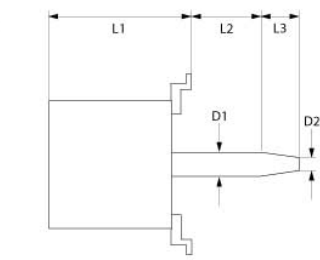

**1**

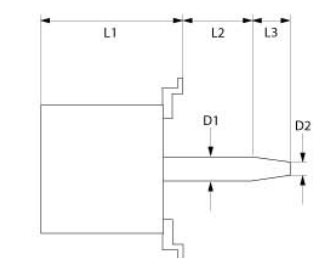
|                    |   |                 |                        |
|--------------------|---|-----------------|------------------------|
| <b>GEV No.</b>     | 601318  | <b>Ref. No.</b> | 12025810<br>RT31001044 |
| <b>description</b> | fan motor 230-240V 1 phase 50Hz 0.450/0.615kW 1440rpm speeds 1 L1 150mm L2 34mm L3 35mm M10x1.5 3.1A type L9Fw4D-397 no. CO D1 ø 17mm D2 ø 13mm |                 |                        |

**1**

|   |  |                 |  |
|---|--|-----------------|--|
| <b>GEV No.</b>  | 601308   | <b>Ref. No.</b> | 12025795<br>12025796<br>RT31001081<br>RT31001084 |
| <b>description</b>  | fan motor 240V 3 phase 60Hz 0.68kW 1730rpm speeds 1 L1 155mm L2 47mm L3 35mm M10R IT 2.9A power input 870W at 60Hz 1730rpm type L9DFw4D-519 no. W8 D1 ø 17mm D2 ø 13mm |                 |  |
| <b>accessories for</b>  | 601308   |                 |  |
|  | <b>GEV No.</b>   | 510573          | <b>Ref. No.</b> 12033667<br>RT50010207           |
|   | shaft seal ID ø 17mm ED ø 29mm thickness 4.5mm   |                 |  |

**1**

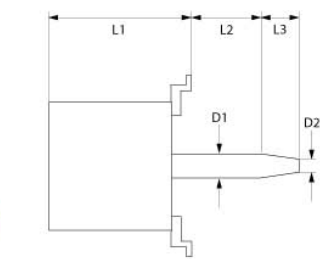
|                    |   |                 |                        |
|--------------------|---|-----------------|------------------------|
| <b>GEV No.</b>     | 601815  | <b>Ref. No.</b> | 12026105<br>RT31001061 |
| <b>description</b> | fan motor 230-240V 1 phase 50Hz 0.450/0.615kW 1440rpm speeds 1 L1 150mm L2 34mm L3 35mm ø 125mm M10x1.5 3.1A type L9Fw4D-397 no. CO D1 ø 17mm D2 ø 13mm kit |                 |                        |

Зип Общепит

vsezip.ru

+7(812)987-08781

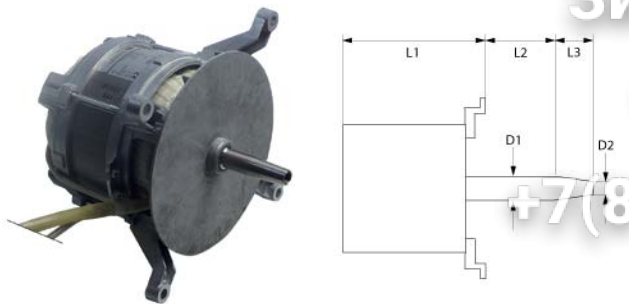

1

|                    |   |                 |  |
|--------------------|---|-----------------|--|
| <b>GEV No.</b>     | 601704  | <b>Ref. No.</b> | 12025608<br>12026125<br>RT31001041<br>RT31001062 |
| <b>description</b> | fan motor 240V 3 phase 60Hz 0.7kW 1720rpm speeds 1 L1 152mm L2 31mm L3 35mm M10L 3A D1 ø 17mm D2 ø 13.5mm |                 |  |



1

|   |  |                 |                        |
|---|--|-----------------|------------------------|
| <b>GEV No.</b>  | 602129   | <b>Ref. No.</b> | 12026111<br>RT31001049 |
| <b>description</b>  | fan motor 380-415V 3 phase 50Hz 0.08/0.45kW 700/1400rpm speeds 2 L1 147mm L2 35mm L3 35mm ø 125mm M10R IT 0.4/1.15A at 50Hz 700/1400rpm Y/YY type L9xw84D-393 no. V2 D1 ø 17mm D2 ø 13mm |                 |                        |
| <b>spare parts for</b>  | 602129   |                 |                        |
|  | <b>GEV No.</b>   | 551350          | <b>Ref. No.</b> —      |
|   | gasket set for motor CPC, CM, CD   |                 |                        |



1

|                    |  |                 |                        |
|--------------------|--|-----------------|------------------------|
| <b>GEV No.</b>     | 602143   | <b>Ref. No.</b> | 12024325<br>T323040000 |
| <b>description</b> | fan motor 3 phase 50Hz 0.75kW 1400rpm L1 150mm L2 45mm L3 37mm D1 ø 17mm D2 ø 14mm 3.2A type 3036AB2350  |                 |                        |
| <b>For models:</b> | ACE-061, ACE-101, ACE-102, ACE-201, ACE-202, ACG-061, ACG-101, ACG-102, ACG-201, ACG-202, AE-061, AE-061W, AE-101, AE-101W, AE-102, AE-102W, AE-201, AE-202, AG-061, AG-061W, AG-101, AG-101W, AG-102, AG-102W, AG-201, AG-202, APE-061, APE-061W, APE-101, APE-101W, APE-102, APE-102W, APE-201, APE-202, APG-061, APG-061W, APG-101, APG-101W, APG-102, APG-102W, APG-201, APG-202, COE-101, COE-201, COG-101, COG-201, VE-101, VE-201, VG-101, VG-201...(Other models you can see in the webshop) |                 |                        |

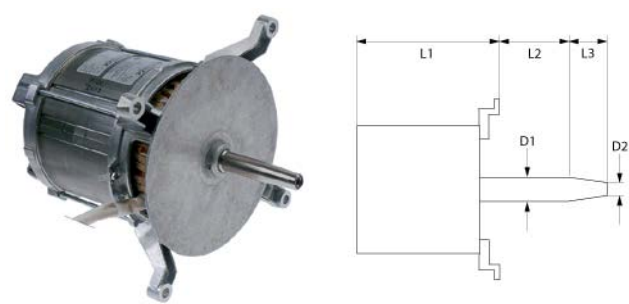

1

|                    |  |                 |                     |
|--------------------|--|-----------------|---------------------|
| <b>GEV No.</b>     | 601504   | <b>Ref. No.</b> | 12018488<br>T323022 |
| <b>description</b> | fan motor 380-415V 3 phase 50Hz 0.12/0.9kW 700/1380rpm speeds 2 L1 202mm L2 48mm L3 35mm M10R IT 0.9/2.1A power input 240/1200W at 50Hz 380-415V at 60Hz 380-480V at 50Hz 700/1380rpm at 60Hz 820/1690rpm Y/YY type L9zw84D-565 no. W4 D1 ø 17mm D2 ø 13.5mm |                 |                     |
| <b>For models:</b> | HEI-10-21, HEM-10-21, HEP-10-21, HGC-10-21, HGP-10-21, HGV-10-21   |                 |                     |

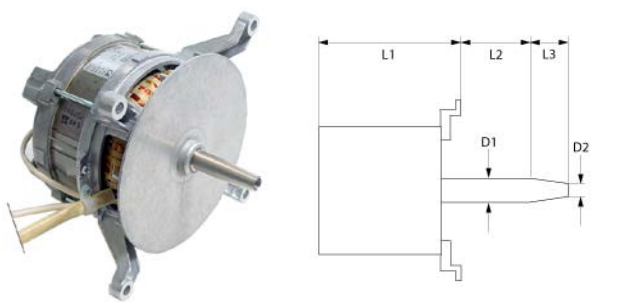

1

|   |  |                 |                        |
|---|--|-----------------|------------------------|
| <b>GEV No.</b>  | 500162   | <b>Ref. No.</b> | 12025820<br>RT31001020 |
| <b>description</b>  | fan motor 380-415V 3 phase 50Hz 0.08/0.45kW 700/1400rpm speeds 2 L1 147mm L2 35mm L3 35mm ø 125mm M10R IT 0.4/1.15A at 50Hz 700/1400rpm Y/YY type L9xw84D-393 no. V2 D1 ø 17mm D2 ø 13mm |                 |                        |
| <b>spare parts for</b>  | 500162   |                 |                        |
|  | <b>GEV No.</b>   | 601730          | <b>Ref. No.</b> —      |
|   | fan wheel for motor cooling ED ø 180mm H 20mm ID ø 20mm  |                 |                        |

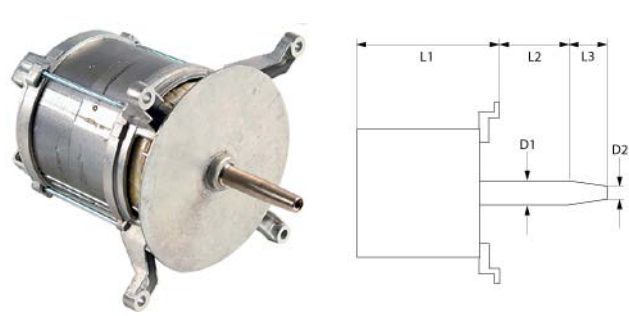

1

|                    |   |                 |                        |
|--------------------|---|-----------------|------------------------|
| <b>GEV No.</b>     | 601299  | <b>Ref. No.</b> | 12025895<br>RT31001068 |
| <b>description</b> | fan motor 380-415V 3 phase 50Hz 0.12/0.9kW 700/1380rpm speeds 2 L1 205mm L2 40mm L3 35mm M10R IT 0.9/2.1A power input 240/1200W at 50Hz 700/1380rpm type L9zw84D-394 no. X4 D1 ø 17mm D2 ø 13mm |                 |                        |

Зип Общепит

vsezip.ru

+7(812)987-08-81

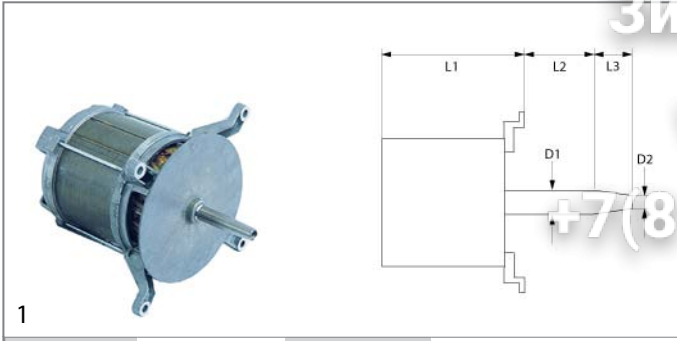

1

|                    |   |                 |                        |
|--------------------|---|-----------------|------------------------|
| <b>GEV No.</b>     | 500168  | <b>Ref. No.</b> | 12025825<br>RT31001022 |
| <b>description</b> | fan motor 380-415V 3 phase 50Hz 0.12/0.9kW 700/1380rpm speeds 2 L1 205mm L2 47mm L3 35mm 0.9/2.1A power input 240/1200W at 50Hz 700/1380rpm type L9zw84D-394 no. X6 D1 ø 13mm D2 ø 13mm L4 17mm |                 |                        |



1

|                    |   |                 |                        |
|--------------------|---|-----------------|------------------------|
| <b>GEV No.</b>     | 602182  | <b>Ref. No.</b> | 12024786<br>T083005000 |
| <b>description</b> | fan wheel blades 12 D1 ø 280mm D2 ø 13mm D3 ø 16.5mm H1 128mm H2 20.5mm H3 80mm |                 |                        |
| <b>For models:</b> | ACG-061, AG-061, AG-061W, APG-061, APG-061W                                     |                 |                        |

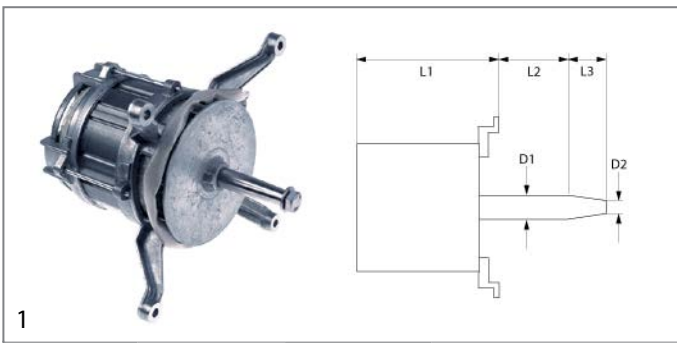

1

|                    |   |                 |                     |
|--------------------|---|-----------------|---------------------|
| <b>GEV No.</b>     | 500507  | <b>Ref. No.</b> | 12016547<br>R663033 |
| <b>description</b> | fan motor 400V 3 phase 50Hz 0.02/0.16kW 710/1390rpm speeds 2 L1 140mm L2 30mm L3 35mm M10R IT 0.2/0.5A power input 50/250W at 50Hz 380-400V at 60Hz 380-400V at 50Hz 710/1390rpm at 60Hz 840/1660rpm Y/YY type L7mw84D-379 no. X2 D1 ø 17mm D2 ø 13mm |                 |                     |
| <b>For models:</b> | HME-10-11, HME-10-21, HME-20-11, HME-20-21, HME-2-10-11, HME-2-20-11, HME-6-11, HMP-10-11, HMP-10-21, HMP-20-11, HMP-20-21, HMP-2-10-11, HMP-2-20-11, HMP-6-11  |                 |                     |



1

|                    |  |                 |                                     |
|--------------------|--|-----------------|-------------------------------------|
| <b>GEV No.</b>     | 601327   | <b>Ref. No.</b> | 12027162<br>22.00.192S<br>RT2200192 |
| <b>description</b> | fan wheel D1 ø 340mm H1 135mm blades 9 D2 ø 13mm D3 ø 16mm H2 38mm |                 |                                     |



1

|                    |           |                 |                        |
|--------------------|-----------|-----------------|------------------------|
| <b>GEV No.</b>     | 601326    | <b>Ref. No.</b> | 12025751<br>RT20120514 |
| <b>description</b> | fan wheel |                 |                        |



1

|                    |   |                 |                       |
|--------------------|---|-----------------|-----------------------|
| <b>GEV No.</b>     | 601306  | <b>Ref. No.</b> | 12027559<br>RT2200188 |
| <b>description</b> | fan wheel D1 ø 340mm H1 95mm blades 9 D2 ø 13mm D3 ø 16mm H2 37mm |                 |                       |

Зип Общепит

vsezip.ru

+7(812)987-08-81



1

|   |  |                 |                                     |
|---|--|-----------------|-------------------------------------|
| <b>GEV No.</b>  | 601503   | <b>Ref. No.</b> | 12016581<br>R253042                 |
| <b>description</b>  | fan wheel D1 ø 350mm H1 125mm blades 12 D2 ø 13mm D3 ø 16mm  |                 |                                     |
| <b>For models:</b>  | HCG-10-11, HCG-10-21, HCG-20-11, HCG-20-21, HCG-2-10-11, HCG-2-20-11, HCV-10-11, HCV-10-21, HCV-2-10-21, HE-10-11, HE-10-21, HE-2-10-11, HG-10-11, HME-10-11, HME-10-21, HME-20-11, HME-20-21, HME-2-10-11, HME-2-20-11, HME-6-11, HMG-10-11, HMG-10-11UL, HMG-10-21, HMG-10-21UL, HMG-20-11, HMG-2-10-11, HMI-10-11, HMI-10-11UL, HMI-10-21, HMI-10-21UL, HMI-2-10-11, HMI-6-11, HMI-6-11UL, HMM-10-11, HMM-10-11UL, HMM-10-21, HMM-10-21UL, HMM-20-11, HMM-20-11UL, HMM-20-21, HMM-20-21UL, HMM-2-10-11, HMM-2-20-11, HMM-40-11-USMC, HMM-6-11, HMM-6-11UL, HMP-10-11, HMP-10-21, HMP-20-11, HMP-20-21...(Other models you can see in the webshop) |                 |                                     |
| <b>accessories for</b>  | 601503   |                 |                                     |
|  | <b>GEV No.</b>   | 500505          | <b>Ref. No.</b> 12016565<br>R253049 |
|   | fan motor 220-240/380-415V 3 phase 50/60Hz 0.16-0.26kW 1440/1700rpm speeds 2 L1 140mm L2 27mm L3 35mm M10R IT 1.2/0.7A Cos(φ) 0.63 type L7zAw4D-014 D1 ø 17mm D2 ø 13mm  |                 |                                     |



1

|                    |   |                 |                        |
|--------------------|---|-----------------|------------------------|
| <b>GEV No.</b>     | 601322  | <b>Ref. No.</b> | 12026355<br>RT20120507 |
| <b>description</b> | fan wheel D1 ø 350mm H1 125mm blades 12 D2 ø 13mm D3 ø 16mm H2 37mm |                 |                        |



1

|                    |   |                 |                        |
|--------------------|---|-----------------|------------------------|
| <b>GEV No.</b>     | 601323  | <b>Ref. No.</b> | 12026699<br>RT20120512 |
| <b>description</b> | fan wheel D1 ø 350mm H1 135mm blades 12 D2 ø 13mm D3 ø 16mm H2 45mm |                 |                        |



1

|                    |   |                 |                                 |
|--------------------|---|-----------------|---------------------------------|
| <b>GEV No.</b>     | 601795  | <b>Ref. No.</b> | 12024306<br>12024789<br>T493017 |
| <b>description</b> | fan wheel D1 ø 350mm H1 125mm blades 12 D2 ø 13mm D3 ø 16mm H2 15mm   |                 |                                 |
| <b>For models:</b> | ACE-061, ACE-101, ACE-102, ACE-201, ACE-202, ACG-101, ACG-102, ACG-201, ACG-202, AE-061, AE-061W, AE-101, AE-101W, AE-102, AE-102W, AE-201, AE-202, AG-101, AG-101W, AG-102, AG-102W, AG-201, AG-202, APE-061, APE-061W, APE-101, APE-101W, APE-102, APE-102W, APE-201, APE-202, APG-101, APG-101W, APG-102, APG-102W, APG-201, APG-202, COE-101, COE-102, COE-201, COE-202, COG-102, COG-202, HEI-20-21, HEM-10-11, HEM-20-11, HEM-20-21, HEM-6-11, HEP-10-11, HEP-20-11...(Other models you can see in the webshop) |                 |                                 |



1

|                    |   |                 |                        |
|--------------------|---|-----------------|------------------------|
| <b>GEV No.</b>     | 601324  | <b>Ref. No.</b> | 12025824<br>RT20120508 |
| <b>description</b> | fan wheel D1 ø 450mm H1 155mm blades 12 D2 ø 13.5mm D3 ø 17mm H2 45mm |                 |                        |



1

|                    |  |                 |                     |
|--------------------|--|-----------------|---------------------|
| <b>GEV No.</b>     | 601502   | <b>Ref. No.</b> | 12018490<br>T303015 |
| <b>description</b> | fan wheel D1 ø 450mm H1 160mm blades 12 D2 ø 13mm D3 ø 17mm      |                 |                     |
| <b>For models:</b> | HEI-10-21, HEM-10-21, HEP-10-21, HGC-10-21, HGP-10-21, HGV-10-21 |                 |                     |

Зип Общепит

vsezip.ru

+7(812)987-08-81

|   |   |                 |                        |
|---|---|-----------------|------------------------|
|  |   |                 |                        |
| 1   |   |                 |                        |
| <b>GEV No.</b>  | 601325  | <b>Ref. No.</b> | 12026227<br>RT20120513 |
| <b>description</b>  | fan wheel D1 ø 450mm H1 165mm blades 12 D2 ø 14mm D3 ø 17mm H2 45mm |                 |                        |

|   |  |                 |                        |
|---|--|-----------------|------------------------|
|  |  |                 |                        |
| 1   |  |                 |                        |
| <b>GEV No.</b>  | 510587   | <b>Ref. No.</b> | 12033987<br>RT20160876 |
| <b>description</b>  | flange for fan motor ED ø 60mm int. ø 1 24mm int. ø 2 18.5mm thickness 3mm steel |                 |                        |

|   |   |                 |                                   |
|---|---|-----------------|-----------------------------------|
|    |   |                 |                                   |
| 1   |   |                 |                                   |
| <b>GEV No.</b>  | 691680  | <b>Ref. No.</b> | 12017909<br>R662623               |
| <b>description</b>  | flange for fan motor ED ø 60mm int. ø 1 28mm int. ø 2 19mm thickness 20mm SS  |                 |                                   |
| <b>For models:</b>  | HCG-10-11, HCG-10-21, HCG-20-11, HCG-20-21, HCG-2-10-11, HCG-2-20-11, HCG-6-11, HME-10-11, HME-10-21, HME-20-11, HME-20-21, HME-2-10-11, HME-2-20-11, HME-6-11, HMG-10-11, HMG-10-11UL, HMG-10-21, HMG-10-21UL, HMG-20-11, HMG-2-10-11, HMG-6-11, HMI-10-11, HMI-10-11UL, HMI-10-21, HMI-10-21UL, HMI-2-10-11, HMI-6-11, HMI-6-11UL, HMM-10-11, HMM-10-11UL, HMM-10-21, HMM-10-21UL, HMM-20-11, HMM-20-11UL, HMM-20-21, HMM-20-21UL, HMM-2-10-11, HMM-2-20-11, HMM-40-11-USMC, HMM-6-11, HMM-6-11UL, HMP-10-11, HMP-10-21, HMP-20-11, HMP-20-21, HMP-2-10-11, HMP-2-20-11, HMP-6-11, HVG-10-11, HVG-10-11UL...(Other models you can see in the webshop) |                 |                                   |
| <b>accessories for</b>  | 691680  |                 |                                   |
|  | <b>GEV No.</b>  | 691049          | <b>Ref. No.</b>                   |
|   |   |                 | 12024510<br>R012635000<br>R662627 |
|   | shaft seal ID ø 17mm ED ø 28mm thickness 7mm  |                 |                                   |

|   |  |                 |                                   |
|---|--|-----------------|-----------------------------------|
|  |  |                 |                                   |
| 1   |  |                 |                                   |
| <b>GEV No.</b>  | 691049   | <b>Ref. No.</b> | 12024510<br>R012635000<br>R662627 |
| <b>description</b>  | shaft seal ID ø 17mm ED ø 28mm thickness 7mm   |                 |                                   |
| <b>For models:</b>  | ACE-061, ACE-101, ACE-102, ACE-201, ACE-202, ACG-061, ACG-101, ACG-102, ACG-201, ACG-202, AE-061, AE-061W, AE-101, AE-101W, AE-102, AE-102W, AE-201, AE-202, AG-061, AG-061W, AG-101, AG-101W, AG-102, AG-102W, AG-201, AG-202, APE-061, APE-061W, APE-101, APE-101W, APE-102, APE-102W, APE-201, APE-202, APG-061, APG-061W, APG-101, APG-101W, APG-102, APG-102W, APG-201, APG-202, COE-061, COE-101, COE-102, COE-201, COE-202, COG-061, COG-101, COG-102...(Other models you can see in the webshop) |                 |                                   |

|  |  |                 |                        |
|--|--|-----------------|------------------------|
|  |  |                 |                        |
| 1  |  |                 |                        |
| <b>GEV No.</b>   | 510573   | <b>Ref. No.</b> | 12033667<br>RT50010207 |
| <b>description</b>   | shaft seal ID ø 17mm ED ø 29mm thickness 4.5mm |                 |                        |

|  |  |                 |                        |
|--|--|-----------------|------------------------|
|  |  |                 |                        |
| 1  |  |                 |                        |
| <b>GEV No.</b>   | 511682   | <b>Ref. No.</b> | 12034102<br>RT85141343 |
| <b>description</b>   | shaft seal kit ID ø 17mm ED ø 29mm shaft seal flange mounting gauge with mountign material |                 |                        |

|   |  |                 |                     |
|---|--|-----------------|---------------------|
|  |  |                 |                     |
| 1   |  |                 |                     |
| <b>GEV No.</b>  | 691891   | <b>Ref. No.</b> | 12024172<br>R663057 |
| <b>description</b>  | spacer bush for fan motor ED ø 9mm H 11mm ID ø 6.5mm   |                 |                     |
| <b>For models:</b>  | COE-061, COE-101, COE-102, COE-201, COE-202, COG-061, COG-101, COG-201, HEM-10-11, HEM-20-11, HEM-6-11, HEP-10-11, HEP-20-11, HEP-6-11, HME-10-11, HME-10-21, HME-20-11, HME-20-21, HME-2-10-11, HME-2-20-11, HME-6-11, HMM-20-11, HMM-20-11UL, HMM-20-21, HMP-10-11, HMP-10-21, HMP-20-11, HMP-20-21, HMP-2-10-11, HMP-2-20-11, HMP-6-11, VE-061, VE-101, VE-102, VE-201, VE-202, VG-101, VG-201, VPE-061, VPE-101, VPE-102, VPE-201, VPE-202, VPG-101, VPG-201 |                 |                     |



Зип Общежит

miscellaneous

hot air fans

ebm-papst

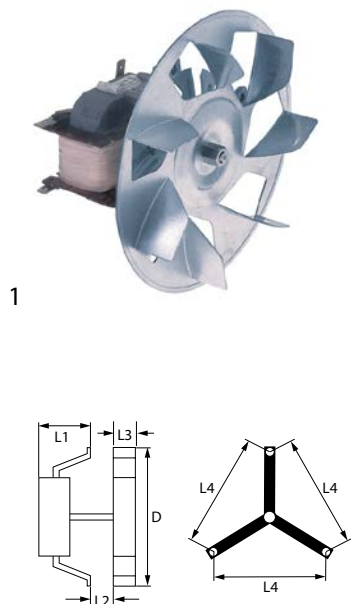

|                    |  |                 |                        |
|--------------------|--|-----------------|------------------------|
| <b>GEV No.</b>     | 601513   | <b>Ref. No.</b> | 12032214<br>6021050005 |
| <b>description</b> | hot air fan 220-240V 41W L1 60mm L2 12mm L3 25mm L4 87mm fan wheel ø 154mm type RRL140/0024 A36-3020LH-459 ebm-papst WS 10 |                 |                        |
| <b>For models:</b> | AC-120, AC-180, CCF-10, CCF-10CI, CCF-20, CCF-20CI, CCF-40, CCF-40CI   |                 |                        |

vsezip.ru  
+7(812)987-08-81

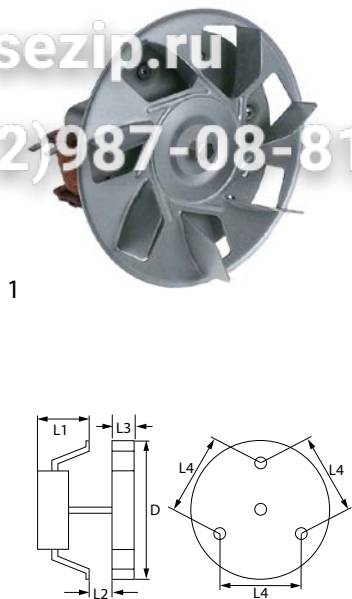

|                        |  |                 |                          |
|------------------------|--|-----------------|--------------------------|
| <b>GEV No.</b>         | 601448   | <b>Ref. No.</b> | 12031294<br>AS30480001   |
| <b>description</b>     | hot air fan 220-240V 32W 50/60Hz L1 60mm L2 11mm L3 25mm L4 87mm fan wheel ø 155mm FIME type C20X0E01/11 |                 |                          |
| <b>spare parts for</b> | 601448   |                 |                          |
|                        |  | <b>GEV No.</b>  | 601261 <b>Ref. No.</b> — |
|                        | fan wheel ø 154mm W 25mm shaft intake ø 6x5mm chrome-plated blades 7                                     |                 |                          |
| <b>accessories for</b> | 601448   |                 |                          |
|                        |  | <b>GEV No.</b>  | 550879 <b>Ref. No.</b> — |
|                        | insulation ø 130mm thickness 3mm hole ø 20mm for hot air fan   |                 |                          |

radial fans

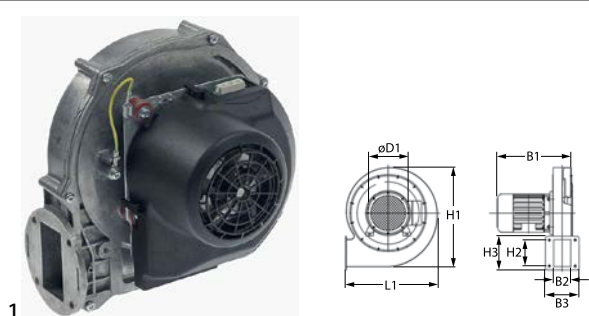

|                    |  |                 |                        |
|--------------------|--|-----------------|------------------------|
| <b>GEV No.</b>     | 602181   | <b>Ref. No.</b> | 12039373<br>T543052000 |
| <b>description</b> | radial fan 230V voltage AC 50/60Hz 135W H1 193mm L1 182mm D1 ø 90mm W1 145mm W2 28mm H2 50mm W3 83mm H3 80mm combi-steamer |                 |                        |
| <b>For models:</b> | AG-202, APG-202  |                 |                        |

electric components

Зип Общепит

vsezip.ru

+7(812)987-08-81

|                    |  |                 |                        |
|--------------------|--|-----------------|------------------------|
| <b>GEV No.</b>     | 601709   | <b>Ref. No.</b> | 12025823<br>RT31011017 |
| <b>description</b> | radial fan 230V voltage AC 50/60Hz H1 180mm L1 175mm D1 ø 43mm W1 82mm W2 33mm H2 60mm W3 83mm H3 83mm for combi-steamer |                 |                        |

|                    |   |                 |  |
|--------------------|---|-----------------|--|
| <b>GEV No.</b>     | 601295  | <b>Ref. No.</b> | 12024797<br>12026033<br>RT7000028<br>T083000 |
| <b>description</b> | radial fan 230V voltage AC 50Hz 50W H1 180mm L1 180mm D1 ø 43mm W1 105mm W2 33mm H2 59mm W3 66mm H3 83mm  |                 |  |
| <b>For models:</b> | COG-061, COG-101, COG-201, HCG-10-11, HCG-10-21, HCG-20-11, HCG-2-10-11, HCG-6-11, HGC-10-11, HGC-20-11, HGC-6-11, HGV-10-11, HGV-20-11, HVG-10-11, HVG-10-11UL, HVG-10-21, HVG-10-21UL, HVG-20-11, HVG-2-10-11, MFHVG-10-11, MFHVG-10-21, VG-101, VG-201, VPG-101, VPG-201 |                 |  |

|                    |   |                 |                       |
|--------------------|---|-----------------|-----------------------|
| <b>GEV No.</b>     | 601296  | <b>Ref. No.</b> | 12025691<br>RT7000067 |
| <b>description</b> | radial fan 230V voltage AC 50Hz 140W H1 190mm L1 190mm D1 ø 50mm W1 133mm W2 28mm H2 55mm W3 83mm H3 83mm |                 |                       |

|                    |  |                 |          |
|--------------------|--|-----------------|----------|
| <b>GEV No.</b>     | 602183   | <b>Ref. No.</b> | 12044607 |
| <b>description</b> | radial fan 230V voltage AC 50Hz 55W H1 156mm L1 160mm D1 ø 126mm W1 90mm H2 50mm W3 83mm combi-steamer                           |                 |          |
| <b>For models:</b> | ACG-061, ACG-101, ACG-102, ACG-201, ACG-202, AG-061, AG-101, AG-102, AG-201, AG-202, APG-061, APG-101, APG-102, APG-201, APG-202 |                 |          |

|                    |   |                 |                        |
|--------------------|---|-----------------|------------------------|
| <b>GEV No.</b>     | 500798  | <b>Ref. No.</b> | 12026360<br>RT31011016 |
| <b>description</b> | radial fan 230V voltage AC 50Hz 25W H1 143mm L1 127mm D1 ø 27mm W1 85mm W2 23mm H2 43mm W3 76mm H3 83mm |                 |                        |

|                    |   |                 |                        |
|--------------------|---|-----------------|------------------------|
| <b>GEV No.</b>     | 601114  | <b>Ref. No.</b> | 12026776<br>RT87201418 |
| <b>description</b> | radial fan 24V voltage AC 50Hz 20W H1 141mm L1 130mm D1 ø 27mm W1 86mm W2 23mm H2 42.5mm W3 75.5mm H3 83mm gas burner |                 |                        |





Зип-Общепит

motors

vsezip.ru

gear motors for tilting bratt pans

87(812)987-08-81

|                    |   |                 |                        |
|--------------------|---|-----------------|------------------------|
| <b>GEV No.</b>     | 601115  | <b>Ref. No.</b> | 12026189<br>RT31011014 |
| <b>description</b> | radial fan 24V voltage AC 50Hz H1 180mm L1 175mm D1 ø 43mm<br>W1 84mm W2 33mm H2 59mm W3 82mm H3 83mm |                 |                        |

|                    |                                      |                 |                     |
|--------------------|--------------------------------------|-----------------|---------------------|
| <b>GEV No.</b>     | 691058                               | <b>Ref. No.</b> | 12016374<br>T093001 |
| <b>description</b> | radial fan 230V voltage AC 50Hz 370W |                 |                     |
| <b>For models:</b> | HCG-20-11, HMG-20-11                 |                 |                     |

|                    |  |                 |                     |
|--------------------|--|-----------------|---------------------|
| <b>GEV No.</b>     | 691868   | <b>Ref. No.</b> | 12016428<br>R723025 |
| <b>description</b> | radial fan 230V voltage AC 60Hz 200W   |                 |                     |
| <b>For models:</b> | HCG-10-11, HCG-10-21, HCG-2-10-11, HCG-6-11, HMG-10-11, HMG-10-11UL, HMG-10-21, HMG-10-21UL, HMG-2-10-11, HMG-6-11 |                 |                     |

|                    |                                      |                 |                     |
|--------------------|--------------------------------------|-----------------|---------------------|
| <b>GEV No.</b>     | 691867                               | <b>Ref. No.</b> | 12016367<br>T093002 |
| <b>description</b> | radial fan 230V voltage AC 60Hz 370W |                 |                     |
| <b>For models:</b> | HCG-20-11, HMG-20-11                 |                 |                     |

|                    |  |                 |                     |
|--------------------|--|-----------------|---------------------|
| <b>GEV No.</b>     | 500348   | <b>Ref. No.</b> | 12016368<br>X343000 |
| <b>description</b> | gear motor ERREKA type 65-T2100CF01 220W 230V 50Hz 1 phase<br>0.27rpm shaft ø 59.5mm L 460mm W 88mm H 88mm for tilting bratt pan     |                 |                     |
| <b>For models:</b> | SBE9-10IM, SBE9-10IMS, SBE9-10M, SBE9-10MS, SBE9-15IM, SBE9-15IMS, SBG9-10IM, SBG9-10IMS, SBG9-10M, SBG9-10MS, SBG9-15IM, SBG9-15IMS |                 |                     |

for ovens

for flues

|                    |   |                 |                                       |
|--------------------|---|-----------------|---------------------------------------|
| <b>GEV No.</b>     | 361999  | <b>Ref. No.</b> | 12031548<br>RT31011010<br>RT31011010S |
| <b>description</b> | gear motor CROUZET type 82841042 12V voltage DC shaft ø 4mm L 65mm W 50mm H 51mm for oven |                 |                                       |

|                        |  |                 |                     |
|------------------------|--|-----------------|---------------------|
| <b>GEV No.</b>         | 530008   | <b>Ref. No.</b> | 12024638<br>T323010 |
| <b>description</b>     | gear motor MECHTEX type SOE-40 3.5W 230V voltage AC 50/60Hz<br>10rpm shaft ø 6x5mm L 65mm W 51mm H 40mm chimney motor  |                 |                     |
| <b>For models:</b>     | ACE-061, ACE-101, ACE-102, ACE-201, ACE-202, ACG-061, ACG-101, ACG-102, ACG-201, ACG-202, AE-061, AE-061W, AE-101, AE-101W, AE-102, AE-102W, AE-201, AE-202, AG-061, AG-061W, AG-101, AG-101W, AG-102, AG-102W, AG-201, AG-202, APE-061, APE-061W, APE-101, APE-101W, APE-102, APE-102W, APE-201, APE-202, APG-061, APG-061W, APG-101, APG-101W, APG-102, APG-102W, APG-201, APG-202, COE-061, COE-101, COE-102, COE-201, COE-202, HEI-10-21, HEI-20-21, HEM-10-21...(Other models you can see in the webshop) |                 |                     |
| <b>spare parts for</b> | 530008   |                 |                     |
|                        | <b>GEV No.</b>   | 360673          | <b>Ref. No.</b> —   |
|                        | motor kit pinion ø 6.8mm teeth 15 230V voltage AC 50/60Hz turn direction clockwise motor ø 48mm H 18.5mm motor type UDS-40NE1RNZ165 cable length 150mm with holder   |                 |                     |

electric components



electric components

Зип,Общепит pumps

wash and rinse pumps vsezip.ru

+7(812)987-08-81 pumps



1

|                    |  |                 |                      |
|--------------------|--|-----------------|----------------------|
| <b>GEV No.</b>     | 500873   | <b>Ref. No.</b> | 1202777<br>RT2200318 |
| <b>description</b> | ventilation valve CROUZET type G70C10AFTEG 12V voltage DC shaft ø 6mm L 95mm W 63mm H 136mm for combi-steamer ø 50mm |                 |                      |

for dishwashers



1

|                    |  |                 |                                |
|--------------------|--|-----------------|--------------------------------|
| <b>GEV No.</b>     | 601662   | <b>Ref. No.</b> | 12023304<br>Z315001<br>Z315006 |
| <b>description</b> | gear motor C.M.E type 71 B 6/4 0.18/0.25W 230V 50Hz 1 phase 1380rpm MI 50 transmission 60/1 for dishwasher   |                 |                                |
| <b>For models:</b> | ECO-280D, ECO-280I, ECO-370D, ECO-370I, ECO-460D, ECO-460I, ECO-550D, ECO-550I, FI-280D, FI-280I, FI-370D, FI-370I, FI-460D, FI-460I, FI-550D, FI-550I |                 |                                |



1

|                    |  |                 |                                |
|--------------------|--|-----------------|--------------------------------|
| <b>GEV No.</b>     | 500783   | <b>Ref. No.</b> | 12024739<br>Z275073<br>Z275074 |
| <b>description</b> | gear motor type 71E00147 250W 230/400V 50/60Hz 3 phase L 365mm W 200mm H 170mm MI 50 transmission 100/1 for dishwasher |                 |                                |
| <b>For models:</b> | ECO-160, ECO-160D, ECO-160I, FI-160, FI-160AR, FI-160D, FI-160I  |                 |                                |

miscellaneous



1

|                    |  |                 |          |
|--------------------|--|-----------------|----------|
| <b>GEV No.</b>     | 501518   | <b>Ref. No.</b> | 12024754 |
| <b>description</b> | gear motor 230V 50/60Hz  |                 |          |
| <b>For models:</b> | AE-102W, APE-061, APE-061W, APE-101, APE-101W, APE-102, APE-102W, APE-201, APE-202, APG-061, APG-061W, APG-101, APG-101W, APG-102, APG-102W, APG-201, APG-202, HEP-10-21, HEP-20-21, HGP-10-21, HGP-20-21, VG-101, VPE-061, VPE-101, VPE-102, VPE-201, VPE-202, VPG-101, VPG-102, VPG-201, VPG-202 |                 |          |



1

|                    |  |                 |                                   |
|--------------------|--|-----------------|-----------------------------------|
| <b>GEV No.</b>     | 499353   | <b>Ref. No.</b> | 12024782<br>T360715<br>T360715000 |
| <b>description</b> | pump inlet ø 30mm outlet ø 26mm type 5213E2451 230V 50Hz 1 phase 0.22kW 0.1HP L 190mm rotation direction left capacitor 5µF FIR      |                 |                                   |
| <b>For models:</b> | APE-201, APE-202, APG-201, APG-202, HEP-10-21, HEP-20-21, HGP-10-21, HGP-20-21, VPE-102, VPE-201, VPE-202, VPG-102, VPG-201, VPG-202 |                 |                                   |



1

|   |   |                 |                 |   |
|---|---|-----------------|-----------------|---|
| <b>GEV No.</b>  | 499334  | <b>Ref. No.</b> | EU929174        |   |
| <b>description</b>  | pump inlet ø 62mm outlet ø 62mm type 2250.2731 230/400V 50Hz 1 phase 3kW FIR  |                 |                 |   |
| <b>spare parts for</b>  | 499334  |                 |                 |   |
|  | <b>GEV No.</b>  | 510687          | <b>Ref. No.</b> | — |
|   | mechanical shaft seal for shaft ø 18mm height counter ring 8mm ID ø 17mm ED ø 39mm H 15mm mounting ø 42mm int. ø 1 21mm |                 |                 |   |
|  | <b>GEV No.</b>  | 512455          | <b>Ref. No.</b> | — |
|   | fan wheel ø 155mm H 18mm shaft intake ø 18mm plastic blades 12  |                 |                 |   |
|  | <b>GEV No.</b>  | 521026          | <b>Ref. No.</b> | — |
|   | pump cover gasket ID ø 182.5mm thickness 5x4.5mm  |                 |                 |   |



Table continues overleaf



Зип Общепит

vsezip.ru

7(812)987-08-81

|   |         |        |          |                      |
|---|---------|--------|----------|----------------------|
| <b>spare parts for</b> 499334   |         |        |          |                      |
|                    | GEV No. | 521028 | Ref. No. | —                    |
| pump cover FIR inlet ø 62mm outlet ø 62mm turn direction right ø 215mm ID ø 175mm inner height 40mm |         |        |          |                      |
|                    | GEV No. | 521277 | Ref. No. | 12038035<br>EU929181 |
| impellor ø 135mm H 39mm pump type Fir 2275 - 3.5HP thread M4L                                       |         |        |          |                      |



1

|   |   |                 |                     |   |
|---|---|-----------------|---------------------|---|
| <b>GEV No.</b>  | 500705  | <b>Ref. No.</b> | 12024812<br>Z101001 |   |
| <b>description</b>  | pump inlet ø 63mm outlet ø 53mm type 1243 230/400V 50Hz 3 phase 2.39kW 3.2HP L 363mm rotation direction left FIR  |                 |                     |   |
| <b>For models:</b>  | ECO-1600, ECO-2300, ECO-280D, ECO-280I, ECO-3000, ECO-370D, ECO-370I, ECO-460D, ECO-460I, ECO-550D, ECO-550I, FI-1600, FI-2300, FI-280D, FI-280I, FI-3000, FI-370D, FI-370I, FI-460D, FI-460I, FI-550D, FI-550I |                 |                     |   |
| <b>spare parts for</b>  | 500705  |                 |                     |   |
|  | GEV No.   | 510357          | Ref. No.            | — |
| impellor ø 124mm H 34/16mm thread M8R blades 6                                      |   |                 |                     |   |

pumps



1

|   |  |                 |                        |   |
|---|--|-----------------|------------------------|---|
| <b>GEV No.</b>  | 500578   | <b>Ref. No.</b> | 12026928<br>RT5600153P |   |
| <b>description</b>  | pump inlet ø 24mm outlet ø 24mm type UP30-274 230V 50/60Hz 1 phase 0.09kW 0.12HP L 145mm rotation direction left capacitor 2.5µF HANNING |                 |                        |   |
| <b>spare parts for</b>  | 500578   |                 |                        |   |
|  | GEV No.  | 501345          | Ref. No.               | — |
| O-ring EPDM thickness 3mm ID ø 58mm Qty 1 pcs                                     |  |                 |                        |   |

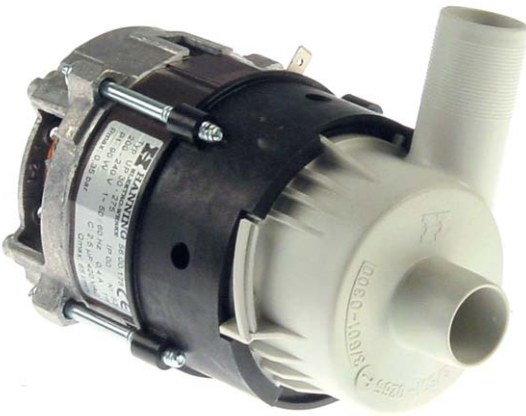

1

|   |  |                 |                        |   |
|---|--|-----------------|------------------------|---|
| <b>GEV No.</b>  | 500579   | <b>Ref. No.</b> | 12026728<br>RT5600178P |   |
| <b>description</b>  | pump inlet ø 24mm outlet ø 24mm type UP30-275 230V 50/60Hz 1 phase 0.09kW 0.12HP L 145mm rotation direction left capacitor 2.5µF HANNING |                 |                        |   |
| <b>spare parts for</b>  | 500579   |                 |                        |   |
|  | GEV No.  | 501345          | Ref. No.               | — |
| O-ring EPDM thickness 3mm ID ø 58mm Qty 1 pcs                                       |  |                 |                        |   |



electric components

Зип Общепит

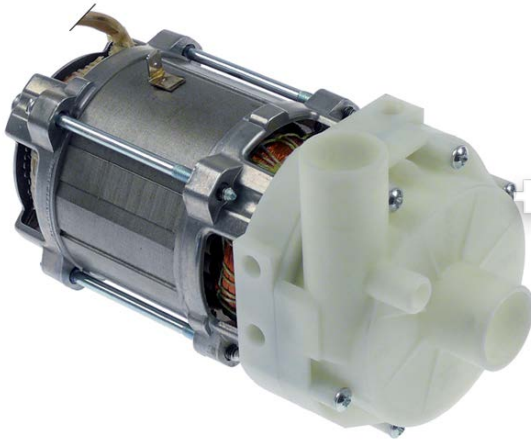

vsezip.ru

+7(812)987-08-81



|   |  |                 |                   |
|---|--|-----------------|-------------------|
| <b>1</b>  |  |                 |                   |
| <b>GEV No.</b>  | 499166   | <b>Ref. No.</b> | 12024233          |
| <b>description</b>  | pump inlet ø 28mm outlet ø 26mm type UP60-414 220-240V 50/60Hz 1 phase 0.25kW L 190mm rotation direction right capacitor 5µF HANNING p max 1bar Qmax. 150l/min   |                 |                   |
| <b>For models:</b>  | AD-125, AD-125HRS, AD-125-SOFT, AD-45BBT, AD-48HY, AD-505, AD-64BBT, AD-64BTDD, AD-64HY, COP-173, COP-173B, COP-173BDD, COP-173DD, COP-173HRS, COP-173HRSDD, COP-173-SOFT, COP-174, COP-174B, COP-174BDD, COP-174DD, COP-174HRS, COP-174HRSDD, COP-174W, COP-174WHRS, COP-503, COP-503B, COP-503BDD, COP-503DD, COP-503-SOFT, COP-504, COP-504B, COP-504BDD, COP-504DD, COP-504W, EASY-500HPWBDD, FI-30B-BT-UK, FI-48B-BT-UK, FI-48HY-CLINIC, FI-64B-BT-UK, FI-64HY-CLINIC |                 |                   |
| <b>spare parts for</b>  | 499166   |                 |                   |
|   | <b>GEV No.</b>   | 365017          | <b>Ref. No.</b> — |
|   | operating capacitor capacity 5µF 450V tolerance 5% 50/60Hz ambient temperature max. -25 to +85°C ø 28mm L 54mm M8 plastic connection male faston 6.3mm 16.10.08 protection   |                 |                   |
|  | <b>GEV No.</b>   | 507558          | <b>Ref. No.</b> — |
|   | mechanical shaft seal for shaft ø 7mm height counter ring 5mm ID ø 6.75mm ED ø 20mm mounting ø counter ring 18.5/slide ring 20mm   |                 |                   |
|  | <b>GEV No.</b>   | 532644          | <b>Ref. No.</b> — |
|   | O-ring EPDM thickness 3mm ID ø 78mm Qty 1 pcs  |                 |                   |



|   |  |                 |                                     |
|---|--|-----------------|-------------------------------------|
| <b>1</b>  |  |                 |                                     |
| <b>GEV No.</b>  | 500321   | <b>Ref. No.</b> | 12023429<br>Z401001                 |
| <b>description</b>  | pump inlet ø 38mm outlet ø 38mm type 2/102FA10 230V 50/60Hz 1 phase 0.26kW 0.35HP L 195mm rotation direction right capacitor 6µF INSERTSTAR  |                 |                                     |
| <b>For models:</b>  | AD-120BBTDD-UK, AD-120HY, AD-15, AD-15D, AD-20C-UK, AD-21, AD-21B, AD-21BDD, AD-21C, AD-21D, AD-21DD, AD-21W, AD-90BBT, ADE-120, ADE-120B, CO-350, CO-350-B, CO-350-B-DD, CO-350-COLD, CO-350-COLD-B, CO-350-COLD-B-DD, CO-350-COLD-DD, CO-350-DD, CO-352-COLD, CO-352-COLD-B, CO-352-COLD-B-DD, CO-352-COLD-DD, CO-400, CO-400-B, CO-400-B-DD, CO-400-COLD, CO-400-COLD-B, CO-400-COLD-B-DD, CO-400-COLD-DD, CO-400-DD, CO-400-SOFT, CO-402-COLD, CO-402-COLD-B, CO-402-COLD-B-DD, CO-402-COLD-DD, CO-402W, ECO-120, ECO-1200, ECO-120B, ECO-160, ECO-160D, ECO-160I, ECO-200, ECO-200D, ECO-200H...(Other models you can see in the webshop) |                 |                                     |
| <b>spare parts for</b>  | 500321   |                 |                                     |
|   | <b>GEV No.</b>   | 504578          | <b>Ref. No.</b> —                   |
|   | O-ring EPDM thickness 3.53mm ID ø 94.84mm Qty 1 pcs  |                 |                                     |
|  | <b>GEV No.</b>   | 510693          | <b>Ref. No.</b> 12018735<br>Z201081 |
|   | mechanical shaft seal for shaft ø 12mm slide ring ext. ø 24mm slide ring H 15.5mm slide ring int. ø 11mm counter ring mounting ø 24mm height counter ring 8mm counter ring int. ø 13.5mm   |                 |                                     |
| <b>accessories for</b>  | 500321   |                 |                                     |
|  | <b>GEV No.</b>   | 365093          | <b>Ref. No.</b> 12024346<br>V817100 |
|   | operating capacitor capacity 6µF 400V tolerance 5% 50/60Hz ambient temperature max. -25 to +85°C ø 31.5mm L 55mm M8 plastic connection male faston 6.3mm protection  |                 |                                     |

Зип Общепит

vsezip.ru

+7(812)987-08-81





1

|                    |  |                 |          |
|--------------------|--|-----------------|----------|
| <b>GEV No.</b>     | 501562   | <b>Ref. No.</b> | 12043287 |
| <b>description</b> | pump inlet ø 38mm outlet ø 38mm type 2/123 FA-22 230V 50Hz 1 phase 0.59kW 0.8HP rotation direction right capacitor 10µF INSERT-STAR  |                 |          |
| <b>For models:</b> | AD-120C, AD-120HY, AD-125, AD-125HRS, AD-125-SOFT, AD-505, AD-505-SOFT, AD-64BTDD, CO-110, CO-110B, CO-110BDD, CO-110DD, CO-112, CO-112B, CO-112BDD, CO-112DD, CO-170, CO-170B, CO-170BDD, CO-170DD, CO-170HRS, CO-170HRSDD, CO-170HRS-SOFT, CO-170-SOFT, CO-172, CO-172B, CO-172BDD, CO-172DD, CO-500, CO-500B, CO-500BDD, CO-500DD, CO-501, CO-501B, CO-501BDD, CO-501DD, CO-501-SOFT, CO-502B, CO-502BDD, CO-502DD, COP-173, COP-173B, COP-173BDD, COP-173DD, COP-173HRS, COP-173HRSDD, COP-173-SOFT, COP-174, COP-174B, COP-174BDD...(Other models you can see in the webshop) |                 |          |









2

|   |  |                 |                                     |
|---|--|-----------------|-------------------------------------|
| <b>GEV No.</b>  | 499075   | <b>Ref. No.</b> | 12024270<br>Z203501<br>Z203511      |
| <b>description</b>  | pump inlet ø 38mm outlet ø 38mm type 2/123 FA31 230V 60Hz 1 phase 0.59kW L 240mm rotation direction right capacitor 10µF INSERTSTAR  |                 |                                     |
| <b>For models:</b>  | AD-120, AD-120B, AD-120C, AD-120CW, AD-48, AD-48W, AD-64, AD-64CW, AD-72, AD-72W, AD-90, AD-90BA, AD-90BDD, AD-90DD, ADE-120, ADE-120B, EASY-500, EASY-500B, EASY-500DD, EASY-500HP, EASY-500HPWBDD, ECO-120, ECO-1200, ECO-120B, ECO-160D, ECO-160I, ECO-200D, ECO-200HD, ECO-200HI, ECO-200I, ECO-370D, ECO-370I, ECO-550D, ECO-550I, FI-100, FI-100AR, FI-100B, FI-100BTT-UK, FI-120, FI-1200, FI-120AR+DD, FI-120B, FI-120C, FI-120HY-CLINIC, FI-120W, FI-160AR, FI-160D, FI-160I, FI-200AR, FI-200D...(Other models you can see in the webshop) |                 |                                     |
| <b>spare parts for</b>  | 499075   |                 |                                     |
|  | <b>GEV No.</b>   | 510693          | <b>Ref. No.</b> 12018735<br>Z201081 |
|   | mechanical shaft seal for shaft ø 12mm slide ring ext. ø 24mm slide ring H 15.5mm slide ring int. ø 11mm counter ring mounting ø 24mm height counter ring 8mm counter ring int. ø 13.5mm   |                 |                                     |
|  | <b>GEV No.</b>   | 521000          | <b>Ref. No.</b> 12019782<br>Z201085 |
|   | pump cover FAGOR inlet ø 38mm outlet ø 38mm  |                 |                                     |
|  | <b>GEV No.</b>   | 532491          | <b>Ref. No.</b> —                   |
|   | O-ring EPDM thickness 3.53mm ID ø 120.2mm Qty 1 pcs  |                 |                                     |
|  | <b>GEV No.</b>   | 650238          | <b>Ref. No.</b> —                   |
|   | impellor ø 77mm H 32mm pump type 2/123 FA31 shaft intake ø 8mm rotation direction right thread M8L suitable for INSERTSTAR shaft ø 12mm shaft length 26mm blades 6   |                 |                                     |

|                    |  |                 |                     |
|--------------------|--|-----------------|---------------------|
| <b>GEV No.</b>     | 365015   | <b>Ref. No.</b> | 12024376<br>V321300 |
| <b>description</b> | operating capacitor capacity 10µF 400V tolerance 5%Hz ambient temperature max. -25 to +85°C ø 35.5mm L 59mm M8 plastic connection male faston 6.3mm protection |                 |                     |



1

|   |  |                 |                                     |
|---|--|-----------------|-------------------------------------|
| <b>GEV No.</b>  | 500320   | <b>Ref. No.</b> | 12024265<br>Z201001<br>Z201011      |
| <b>description</b>  | pump inlet ø 38mm outlet ø 38mm type 2/123/FA30 230V 50Hz 1 phase 0.59kW 0.8HP L 235mm rotation direction right capacitor 10µF INSERTSTAR  |                 |                                     |
| <b>For models:</b>  | AD-120, AD-120B, AD-120BBTDD-UK, AD-120C, AD-120HY, AD-45BBT, AD-48, AD-48B, AD-48BDD, AD-48C, AD-48D, AD-48DD, AD-48HY, AD-64, AD-64B, AD-64BBT, AD-64BDD, AD-64BTDD, AD-64C, AD-64D, AD-64DD, AD-64HY, AD-72, AD-90, AD-90BA, AD-90BBT, AD-90BDD, AD-90DD, ADE-120, ADE-120B, EASY-500, EASY-500B, EASY-500DD, EASY-500HP, EASY-500HPWBDD, ECO-120, ECO-1200, ECO-120B, ECO-160, ECO-1600, ECO-160D, ECO-160I, ECO-200, ECO-200D, ECO-200H, ECO-200HD, ECO-200HI, ECO-200I, ECO-2300, ECO-3000...(Other models you can see in the webshop) |                 |                                     |
| <b>spare parts for</b>  | 500320   |                 |                                     |
|  | <b>GEV No.</b>   | 510693          | <b>Ref. No.</b> 12018735<br>Z201081 |
|   | mechanical shaft seal for shaft ø 12mm slide ring ext. ø 24mm slide ring H 15.5mm slide ring int. ø 11mm counter ring mounting ø 24mm height counter ring 8mm counter ring int. ø 13.5mm   |                 |                                     |
|  | <b>GEV No.</b>   | 521000          | <b>Ref. No.</b> 12019782<br>Z201085 |
|   | pump cover FAGOR inlet ø 38mm outlet ø 38mm  |                 |                                     |
|  | <b>GEV No.</b>   | 521255          | <b>Ref. No.</b> 12018550<br>Z201082 |
|   | impellor ø 88mm H 33mm M8L pump type 2/123/FA30 shaft ø 12mm   |                 |                                     |
|  | <b>GEV No.</b>   | 532491          | <b>Ref. No.</b> —                   |
|   | O-ring EPDM thickness 3.53mm ID ø 120.2mm Qty 1 pcs  |                 |                                     |
| <b>accessories for</b>  | 500320   |                 |                                     |
|  | <b>GEV No.</b>   | 365015          | <b>Ref. No.</b> 12024376<br>V321300 |
|   | operating capacitor capacity 10µF 400V tolerance 5%Hz ambient temperature max. -25 to +85°C ø 35.5mm L 59mm M8 plastic connection male faston 6.3mm protection   |                 |                                     |
|  | <b>GEV No.</b>   | 551227          | <b>Ref. No.</b> —                   |
|   | female faston size 6.3x0.8mm 1.0-2.5mm <sup>2</sup> straight CuZn gal Sn t.max. 110°C Qty 10 pcs   |                 |                                     |

electric components



booster pumps I

Зип Общепит

vsezip.ru

+7(812)987-08-81



1

|                    |  |                 |                     |
|--------------------|--|-----------------|---------------------|
| <b>GEV No.</b>     | 499155   | <b>Ref. No.</b> | 12023344<br>Z209508 |
| <b>description</b> | pump inlet ø 1" IT outlet ø 1" IT type PRISMA15 230V 50Hz 0.6kW L 400mm capacitor 12µF   |                 |                     |
| <b>For models:</b> | ECO-120, ECO-1200, FI-100, FI-120, FI-1200, FI-120W, FI-30, FI-30AR, FI-30AR+DD, FI-30-UK, FI-48, FI-48AR, FI-48B, FI-48B-BT-UK, FI-48C, FI-48D, FI-48HY-CLINIC, FI-48W, FI-50, FI-64, FI-64AR, FI-64B, FI-64B-BT-UK, FI-64C, FI-64D, FI-64HY-CLINIC, FI-64W, FI-72, FI-72AR, FI-72W, FI-900, MF-48, MF-64 |                 |                     |



1

|                    |  |                 |                                  |
|--------------------|--|-----------------|----------------------------------|
| <b>GEV No.</b>     | 499073   | <b>Ref. No.</b> | 12017575<br>12017826<br>12024708 |
| <b>description</b> | pump inlet ø 31 outlet ø 27 type 887084885 230V 50Hz 0.75kW L 146mm capacitor 2.5µF NIDEC  |                 |                                  |
| <b>For models:</b> | APE-061, APE-101, APE-102, APG-061, APG-101, APG-102, FI-30B-BT-UK, FI-48B-BT-UK, FI-48HY-CLINIC, FI-64B-BT-UK, FI-64HY-CLINIC, VPE-061, VPE-101 |                 |                                  |

drain pumps

COPRECI



1

|                    |   |                 |                     |
|--------------------|---|-----------------|---------------------|
| <b>GEV No.</b>     | 500322  | <b>Ref. No.</b> | 12024273<br>Z220901 |
| <b>description</b> | drain pump inlet ø 25mm outlet ø 22mm 230V 30W 50Hz COPRECI   |                 |                     |
| <b>For models:</b> | AD-20C-UK, AD-21B, AD-21BDD, AD-21C, AD-45BBT, AD-48B, AD-48BDD, AD-48C, AD-48HY, AD-64B, AD-64BBT, AD-64BDD, AD-64C, AD-64HY, FI-30, FI-30AR, FI-30AR+DD, FI-30B, FI-30B-BT-UK, FI-30-UK, FI-48, FI-48AR, FI-48B, FI-48B-BT-UK, FI-48C, FI-48D, FI-48HY-CLINIC, FI-48W, FI-64, FI-64AR, FI-64B, FI-64B-BT-UK, FI-64C, FI-64D, FI-64HY-CLINIC, FI-64W, GA-20, GA-20D, GA-40, GA-40D, HEM-10-21, HEM-20-21, HEP-10-21, HEP-20-21, HGP-10-21, HGP-20-21, HGV-10-21, HGV-20-21, LVC-21B, LVC-21C...(Other models you can see in the webshop) |                 |                     |



1

|                    |  |                 |                        |
|--------------------|--|-----------------|------------------------|
| <b>GEV No.</b>     | 500573   | <b>Ref. No.</b> | 12029471<br>RT4400207P |
| <b>description</b> | drain pump 30W 4-piece 230V inlet ø 24/30mm outlet ø 24mm 50Hz HANNING type DPS25-032 1x pump, 3x pump cover |                 |                        |



1

|                    |  |                 |          |
|--------------------|--|-----------------|----------|
| <b>GEV No.</b>     | 501561   | <b>Ref. No.</b> | 12094265 |
| <b>description</b> | drain pump 38W 200-240V inlet ø 30mm outlet ø 24mm 50/60Hz HANNING type DP25R-396  |                 |          |
| <b>For models:</b> | AD-505, AD-505-SOFT, CO-350-B, CO-350-B-DD, CO-350-COLD-B, CO-350-COLD-B-DD, CO-352-COLD-B, CO-352-COLD-B-DD, CO-400-B, CO-400-B-DD, CO-400-COLD-B, CO-400-COLD-B-DD, CO-402-COLD-B, CO-402-COLD-B-DD, CO-402W, CO-500B, CO-500BDD, CO-501B, CO-501BDD, CO-502B, CO-502BDD, CO-502W, COP-503B, COP-503BDD, COP-504B, COP-504BDD, COP-504W, EASY-500B, EASY-500DD |                 |          |



1

|                    |  |                 |                        |
|--------------------|--|-----------------|------------------------|
| <b>GEV No.</b>     | 501595   | <b>Ref. No.</b> | 12039546<br>T843060000 |
| <b>description</b> | drain pump 38W 200-240V inlet ø 30mm outlet ø 24mm 50-60Hz HANNING type DPS25R-391 max. 15min input current 0.4A   |                 |                        |
| <b>For models:</b> | ACE-061, ACE-102, AE-061, AE-061W, AE-101, AE-101W, AE-102, AE-102W, AE-201, AE-202, AG-061, AG-061W, AG-101, AG-101W, AG-102, AG-102W, AG-201, AG-202, APE-061, APE-061W, APE-101, APE-101W, APE-102, APE-102W, APE-201, APE-202, APG-061, APG-061W, APG-101, APG-101W, APG-102, APG-102W, APG-201, APG-202 |                 |                        |

Зип Общепит

SERVICE

vsezip.ru HANNING

+7(812)987-08-81

electric components

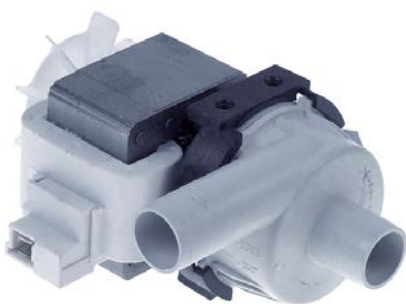

1

|                    |  |                 |                     |
|--------------------|--|-----------------|---------------------|
| <b>GEV No.</b>     | 500737   | <b>Ref. No.</b> | 12023456<br>Z711007 |
| <b>description</b> | drain pump inlet ø 24mm outlet ø 24mm 230V 95W 50Hz HANNING type BE38B5-017  |                 |                     |
| <b>For models:</b> | AD-120B, AD-120BBTDD-UK, AD-120C, AD-120HY, AD-125, AD-125HRS, AD-125-SOFT, AD-90BA, AD-90BBT, AD-90BDD, ADE-120B, CO-110B, CO-110BDD, CO-112B, CO-112BDD, CO-170B, CO-170BDD, CO-172B, CO-172BDD, COP-173B, COP-173BDD, COP-174B, COP-174BDD, ECO-120B, FI-100, FI-100AR, FI-100B, FI-100BBT-UK, FI-120B, FI-120C, FI-120HY-CLINIC, FI-80BBT-UK |                 |                     |



1

|                    |  |                 |                        |
|--------------------|--|-----------------|------------------------|
| <b>GEV No.</b>     | 500573   | <b>Ref. No.</b> | 12029471<br>RT4400207P |
| <b>description</b> | drain pump 30W 4-piece 230V inlet ø 24/30mm outlet ø 24mm 50Hz HANNING type DPS25-032 1x pump, 3x pump cover |                 |                        |

booster pumps II

accessories



1

|   |  |                 |                                     |
|---|--|-----------------|-------------------------------------|
| <b>GEV No.</b>  | 500044   | <b>Ref. No.</b> | 12029264<br>12029492<br>RT30021000P |
| <b>description</b>  | drain pump inlet ø 30mm outlet ø 24mm 230V 100W 50Hz HANNING type BE28B4-017 |                 |                                     |
| <b>spare parts for</b>  | 500044   |                 |                                     |
|  | <b>GEV No.</b>   | 510168          | <b>Ref. No.</b> —                   |
|   | fan wheel shaft intake ø 5mm ø 62mm H 14mm                                   |                 |                                     |



1

|                    |  |                 |                     |
|--------------------|--|-----------------|---------------------|
| <b>GEV No.</b>     | 365015   | <b>Ref. No.</b> | 12024376<br>V321300 |
| <b>description</b> | operating capacitor capacity 10µF 400V tolerance 5%Hz ambient temperature max. -25 to +85°C ø 35.5mm L 59mm M8 plastic connection male faston 6.3mm protection   |                 |                     |
| <b>For models:</b> | AD-120, AD-120B, AD-120BBTDD-UK, AD-120C, AD-120CW, AD-120HY, AD-125, AD-125HRS, AD-125-SOFT, AD-45BBT, AD-48, AD-48B, AD-48BDD, AD-48C, AD-48D, AD-48DD, AD-48HY, AD-48W, AD-505, AD-505-SOFT, AD-64, AD-64B, AD-64BBT, AD-64BDD, AD-64BTDD, AD-64C, AD-64CW, AD-64D, AD-64DD, AD-64HY, AD-72, AD-72W, AD-90, AD-90BA, AD-90BBT, AD-90BDD, AD-90DD, ADE-120, ADE-120B, CO-110, CO-110B, CO-110BDD, CO-110DD, CO-112, CO-112B, CO-112BDD, CO-112DD, CO-142W, CO-142WDD, CO-170...(Other models you can see in the webshop) |                 |                     |



1

|                    |  |                 |                        |
|--------------------|--|-----------------|------------------------|
| <b>GEV No.</b>     | 501542   | <b>Ref. No.</b> | 12029791<br>RT30021005 |
| <b>description</b> | drain pump inlet ø 30mm outlet ø 24mm 230V 32W |                 |                        |



1

|                    |  |                 |            |
|--------------------|--|-----------------|------------|
| <b>GEV No.</b>     | 365012   | <b>Ref. No.</b> | SAM4420032 |
| <b>description</b> | operating capacitor capacity 6.3µF 450V tolerance 5% 50Hz ambient temperature max. -25 to +85°C ø 30mm L 61mm M8 plastic connection male faston 6.3mm protection |                 |            |



vibration pumps



1

|                    |   |                 |                        |
|--------------------|---|-----------------|------------------------|
| <b>GEV No.</b>     | 500580  | <b>Ref. No.</b> | 12028569<br>RT87201526 |
| <b>description</b> | vibration pump 230V 60W 50/60Hz inlet ø 7 outlet ø 1/8" IT CEME type E512 with accessories duty cycle 1/2 ambient temperature max. 60°C medium temp max. 35°C overheating protection 110°C CleanJet |                 |                        |

pumps for ice machines



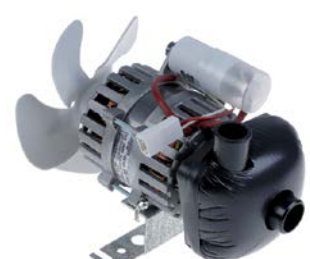

1

|   |  |                 |                        |                        |
|---|--|-----------------|------------------------|------------------------|
| <b>GEV No.</b>  | 500590   | <b>Ref. No.</b> | 12028429<br>BR00023377 |                        |
| <b>description</b>  | pump FIR type 4240.2300 120W 230V 50/60Hz inlet ø 22mm outlet ø 22mm L 240mm rotation direction right for ice-cube maker capacitor 5µF |                 |                        |                        |
| <b>spare parts for</b>  | 500590   |                 |                        |                        |
|  | <b>GEV No.</b>   | 601412          | <b>Ref. No.</b>        | 12037081<br>BR00010213 |
|   | fan wheel sucking ø 154mm fan wheel mounting 25.4mm blade angle 28° W 34mm plastic   |                 |                        |                        |
|  | <b>GEV No.</b>   | 601413          | <b>Ref. No.</b>        | —                      |
|   | fixing plate suitable for fanwheel ED ø 32mm shaft ø 7 mounting distance 26mm  |                 |                        |                        |



1

|   |  |                 |                        |                        |
|---|--|-----------------|------------------------|------------------------|
| <b>GEV No.</b>  | 500165   | <b>Ref. No.</b> | 12028445<br>BR00023002 |                        |
| <b>description</b>  | pump REBO type 63/35 120W 230V 50/60Hz inlet ø 28mm outlet ø 26mm L 180mm rotation direction right for ice-cube maker capacitor 5µF  |                 |                        |                        |
| <b>spare parts for</b>  | 500165   |                 |                        |                        |
|  | <b>GEV No.</b>   | 365017          | <b>Ref. No.</b>        | —                      |
|   | operating capacitor capacity 5µF 450V tolerance 5% 50/60Hz ambient temperature max. -25 to +85°C ø 28mm L 54mm M8 plastic connection male faston 6.3mm 16.10.08 protection |                 |                        |                        |
|  | <b>GEV No.</b>   | 601412          | <b>Ref. No.</b>        | 12037081<br>BR00010213 |
|   | fan wheel sucking ø 154mm fan wheel mounting 25.4mm blade angle 28° W 34mm plastic   |                 |                        |                        |

Зиг-Общепит

vsezip.ru

+7(812)987-08-81

|                        |   |   |        |                 |   |
|------------------------|---|---|--------|-----------------|---|
| <b>spare parts for</b> | 500165  | <b>GEV No.</b>  | 601413 | <b>Ref. No.</b> | — |
|                        |  | fixing plate suitable for fanwheel ED ø 32mm shaft ø 7 mounting distance 26mm |        |                 |   |



1

|  |  |                 |                        |                        |
|--|--|-----------------|------------------------|------------------------|
| <b>GEV No.</b>   | 500166   | <b>Ref. No.</b> | 12028448<br>BR00023068 |                        |
| <b>description</b>   | pump REBO type 63/45 150W 230V 50/60Hz inlet ø 28mm outlet ø 26mm L 200mm rotation direction right capacitor 5µF   |                 |                        |                        |
| <b>spare parts for</b>   | 500166   |                 |                        |                        |
|   | <b>GEV No.</b>   | 365017          | <b>Ref. No.</b>        | —                      |
|  | operating capacitor capacity 5µF 450V tolerance 5% 50/60Hz ambient temperature max. -25 to +85°C ø 28mm L 54mm M8 plastic connection male faston 6.3mm 16.10.08 protection |                 |                        |                        |
|   | <b>GEV No.</b>   | 601412          | <b>Ref. No.</b>        | 12037081<br>BR00010213 |
|  | fan wheel sucking ø 154mm fan wheel mounting 25.4mm blade angle 28° W 34mm plastic   |                 |                        |                        |
|  | <b>GEV No.</b>   | 601413          | <b>Ref. No.</b>        | —                      |
|  | fixing plate suitable for fanwheel ED ø 32mm shaft ø 7 mounting distance 26mm  |                 |                        |                        |

|   |  |                 |                        |   |
|---|--|-----------------|------------------------|---|
| <b>GEV No.</b>  | 500161   | <b>Ref. No.</b> | 12026128<br>BR00C23076 |   |
| <b>description</b>  | pump REBO type NR40 55W 230V 50Hz outlet ø 17mm L 110mm rotation direction left for ice-cube maker |                 |                        |   |
| <b>spare parts for</b>  | 500161   |                 |                        |   |
|  | <b>GEV No.</b>   | 500970          | <b>Ref. No.</b>        | — |
|   | pump motor 55W 230V 50Hz REBO L 205mm type outlet ømm suitable for for ice maker                   |                 |                        |   |



1

|   |  |                 |                        |   |
|---|--|-----------------|------------------------|---|
| <b>GEV No.</b>  | 500161   | <b>Ref. No.</b> | 12026128<br>BR00C23076 |   |
| <b>description</b>  | pump REBO type NR40 55W 230V 50Hz outlet ø 17mm L 110mm rotation direction left for ice-cube maker |                 |                        |   |
| <b>spare parts for</b>  | 500161   |                 |                        |   |
|  | <b>GEV No.</b>   | 500970          | <b>Ref. No.</b>        | — |
|   | pump motor 55W 230V 50Hz REBO L 205mm type outlet ømm suitable for for ice maker                   |                 |                        |   |





condensators & interference suppression filters

Зип Общепит

operating capacitors

starting capacitors

starting capacitors



1

|                    |  |                 |                                      |
|--------------------|--|-----------------|--------------------------------------|
| <b>GEV No.</b>     | 365061   | <b>Ref. No.</b> | 12033454<br>6004000008<br>6021010037 |
| <b>description</b> | starting capacitor 220/300V 50Hz DANFOSS duty cycle 1.7/0.10% capacity 80µF for FR/NL  |                 |                                      |
| <b>For models:</b> | AEP-701, AEP-702, AEP-801, AEP-802, AF-1402-MIX, AF-1602-MIX, AF-1603-C, AF-1603-P, AF-1604-C, AF-1604-P, AF-702-C, AF-702-P, AFN-701, AFP-1402-MIX, AFP-1602, AFP-1602-2, AFP-1603, AFP-1603-2, AFP-701, AFP-702, AFP-702-C, AFP-702-P, AFP-801, AFP-802, AFP-802-2, AFP-802-2C, AFP-802-3C, BFP-150, BFP-150A, BFP-150I, BFP-200, BFP-200A, BFP-200I, CAEP-701, CAEP-801, CAEP-802, CAF-1402MIXT, CAF-1602MIX, CAFP-1602-2, CAFP-1603-2, CAFP-701, CAFP-702, CAFP-801, CAFP-802, CAFP-802-2C, CAFP-802-3C, CFMP-150, CFMP-150F, CFMP-150PC, CFMP-150TV...(Other models you can see in the webshop) |                 |                                      |



1

|                    |  |                 |                                      |
|--------------------|--|-----------------|--------------------------------------|
| <b>GEV No.</b>     | 365062   | <b>Ref. No.</b> | 12018649<br>6004000009<br>6021010035 |
| <b>description</b> | starting capacitor 80µF 220/300V 50/60Hz duty cycle 3min/1min ø 38mm L 98mm plastic connection cable 100mm   |                 |                                      |
| <b>For models:</b> | AEP-1402, AEP-1403, AEP-1404, AEP-1602, AEP-1603, AEP-1604, AEP-2103, AF-1402-MIX, AF-1403-C, AF-1403-P, AF-1404-C, AF-1404-P, AF-1602-MIX, AF-1603-C, AF-1604-C, AF-2104-C, AF-2104-P, AF-2105-C, AF-2105-P, AF-2106-C, AF-2106-P, AF-702-C, AF-702-P, AF-802-C, AFN-701, AFN-702, AFN-801, AFN-802, AFP-1402, AFP-1402-MIX, AFP-1403, AFP-1403-C, AFP-1403-P, AFP-1404, AFP-1404-C, AFP-1404-P, AFP-1602, AFP-1602-2, AFP-1603, AFP-1603-2, AFP-1604, AFP-2103, AFP-2104, AFP-2104-C, AFP-2104-P, AFP-2105, AFP-2105-C, AFP-2105-P, AFP-2106, AFP-2106-C...(Other models you can see in the webshop) |                 |                                      |

plastic vsezip.ru



1

|                    |   |                 |                     |
|--------------------|---|-----------------|---------------------|
| <b>GEV No.</b>     | 365015  | <b>Ref. No.</b> | 12024376<br>V321300 |
| <b>description</b> | operating capacitor capacity 10µF 400V tolerance 5%Hz ambient temperature max. -25 to +85°C ø 35.5mm L 59mm M8 plastic connection male faston 6.3mm protection  |                 |                     |
| <b>For models:</b> | AD-120, AD-120B, AD-120BBTDD-UK, AD-120C, AD-120CW, AD-120HY, AD-125, AD-125SHRS, AD-125-SOFT, AD-45BBT, AD-48, AD-48B, AD-48BDD, AD-48C, AD-48D, AD-48DD, AD-48HY, AD-48W, AD-505, AD-505-SOFT, AD-64, AD-64B, AD-64BBT, AD-64BDD, AD-64BTDD, AD-64C, AD-64CW, AD-64D, AD-64DD, AD-64HY, AD-72, AD-72W, AD-90, AD-90BA, AD-90BBT, AD-90BDD, AD-90DD, ADE-120, ADE-120B, CO-110, CO-110B, CO-110BDD, CO-110DD, CO-112, CO-112B, CO-112BDD, CO-112DD, CO-142W, CO-142WDD, CO-170...(Other models you can see in the webshop) |                 |                     |



1

|                    |   |                 |                     |
|--------------------|---|-----------------|---------------------|
| <b>GEV No.</b>     | 365020  | <b>Ref. No.</b> | 12020898<br>R293000 |
| <b>description</b> | operating capacitor capacity 14µF 400V tolerance 5%Hz ambient temperature max. -25 to +85°C ø 35mm L 70mm M8 plastic connection male faston 6.3mm protection  |                 |                     |
| <b>For models:</b> | HCG-10-11, HCG-10-21, HCG-2-10-11, HCG-6-11, HCV-10-11, HCV-10-21, HCV-2-10-21, HCV-5-11, HCV-6-11, HE-5-11, HG-10-11, HG-10-21, HG-2-10-11, HMG-10-11, HMG-10-11UL, HMG-10-21, HMG-10-21UL, HMG-2-10-11, HMG-6-11, HVG-10-11, HVG-10-11UL, HVG-10-21, HVG-10-21UL, HVG-2-10-11, MFHVG-10-11, MFHVG-10-21 |                 |                     |



1

|                    |  |                 |                        |
|--------------------|--|-----------------|------------------------|
| <b>GEV No.</b>     | 365226   | <b>Ref. No.</b> | 12025135<br>Z258927000 |
| <b>description</b> | operating capacitor capacity 3µF 450V with plastic sheathing tolerance 5% 50/60Hz ø 34mm L 64mm  |                 |                        |
| <b>For models:</b> | ACE-102, AE-061W, AE-101W, AE-102, AG-061W, APE-061, APE-061W, APE-101, APE-101W, APE-102, APE-102W, APG-061, APG-061W, APG-101, APG-101W, APG-102, APG-102W |                 |                        |



1

|                    |  |                 |                     |
|--------------------|--|-----------------|---------------------|
| <b>GEV No.</b>     | 365035   | <b>Ref. No.</b> | 12020052<br>T093005 |
| <b>description</b> | operating capacitor capacity 30µF 400V tolerance 5% 50/60Hz ambient temperature max. -25 to +85°C ø 45mm L 95mm M8 plastic connection male faston 6.3mm protection |                 |                     |
| <b>For models:</b> | HCG-20-11, HCG-20-21, HCG-2-20-11, HMG-20-11, HVG-20-11, HVG-20-21, HVG-2-20-21  |                 |                     |

electric components



ЗипОбщепит

filters

vsezip.ru

(812)987-08-81



|                    |  |                 |                     |
|--------------------|--|-----------------|---------------------|
| <b>GEV No.</b>     | 365029   | <b>Ref. No.</b> | 12039812<br>X343001 |
| <b>description</b> | operating capacitor capacity 5µF with plastic sheathing  |                 |                     |
| <b>For models:</b> | SBE9-10IM, SBE9-10IMS, SBE9-10M, SBE9-10MS, SBE9-15IM, SBE9-15IMS, SBG9-10IM, SBG9-10IMS, SBG9-10M, SBG9-10MS, SBG9-15IM, SBG9-15IMS |                 |                     |



|                    |  |                 |            |
|--------------------|--|-----------------|------------|
| <b>GEV No.</b>     | 365012   | <b>Ref. No.</b> | SAM4420032 |
| <b>description</b> | operating capacitor capacity 6.3µF 450V tolerance 5% 50Hz ambient temperature max. -25 to +85°C ø 30mm L 61mm M8 plastic connection male faston 6.3mm protection |                 |            |



|                    |  |                 |                     |
|--------------------|--|-----------------|---------------------|
| <b>GEV No.</b>     | 365093   | <b>Ref. No.</b> | 12024346<br>V817100 |
| <b>description</b> | operating capacitor capacity 6µF 400V tolerance 5% 50/60Hz ambient temperature max. -25 to +85°C ø 31.5mm L 55mm M8 plastic connection male faston 6.3mm protection  |                 |                     |
| <b>For models:</b> | AD-120BBTDD-UK, AD-120HY, AD-15, AD-15D, AD-20C-UK, AD-21, AD-21B, AD-21BDD, AD-21C, AD-21D, AD-21DD, AD-21W, AD-90BBT, ADE-120, ADE-120B, CO-350, CO-350-B, CO-350-B-DD, CO-350-COLD, CO-350-COLD-B, CO-350-COLD-B-DD, CO-350-COLD-DD, CO-350-DD, CO-352-COLD, CO-352-COLD-B, CO-352-COLD-B-DD, CO-352-COLD-DD, CO-400, CO-400-B, CO-400-B-DD, CO-400-COLD, CO-400-COLD-B, CO-400-COLD-B-DD, CO-400-COLD-DD, CO-400-SOFT, CO-402-COLD, CO-402-COLD-B, CO-402-COLD-B-DD, CO-402-COLD-DD, CO-402W, ECO-120, ECO-120B, ECO-160, ECO-160D, ECO-160I, ECO-200, ECO-200D, ECO-200H, ECO-200HD...(Other models you can see in the webshop) |                 |                     |

metal



|                    |  |                 |                      |
|--------------------|--|-----------------|----------------------|
| <b>GEV No.</b>     | 365139   | <b>Ref. No.</b> | 12032744<br>EU206002 |
| <b>description</b> | operating capacitor capacity 10µF 450V tolerance 5% 60Hz ambient temperature max. -25 up to +70°C ø 40mm L 83mm M8 aluminium connection male faston 6.3mm C.87.8BF2 MKP protection |                 |                      |

|   |  |                 |          |
|---|--|-----------------|----------|
| <b>interference suppression filters</b> |  |                 |          |
| <b>GEV No.</b>                          | 365217   | <b>Ref. No.</b> | 12035029 |
| <b>description</b>                      | interference suppression filter capacity 1.5µF 250V for combi-steamer CPC-Linie 61-202 |                 |          |



|                    |  |                 |                        |
|--------------------|--|-----------------|------------------------|
| <b>GEV No.</b>     | 365108   | <b>Ref. No.</b> | 12029809<br>RT30010455 |
| <b>description</b> | interference suppression filter type 3001.0455 250/440V 50/60Hz conductor 3 with E connection male faston 6.3mm L 52mm ø 60mm Hmm Wmm M8 aluminium Qty 1 pcs |                 |                        |

line filters with housing

|                    |  |                 |                     |
|--------------------|--|-----------------|---------------------|
| <b>GEV No.</b>     | 365103   | <b>Ref. No.</b> | 12017894<br>T113023 |
| <b>description</b> | line filter type FF-6Z 110/250V 50/60Hz conductor 2 with E connection male faston 6.3mm L 90mm H 29.5mm W 51mm flange metal Qty 1 pcs  |                 |                     |
| <b>For models:</b> | HCG-10-11, HCG-10-21, HCG-20-11, HCG-20-21, HCG-2-10-11, HCG-2-20-11, HCG-6-11, HEI-10-21, HEM-10-21, HGC-10-11, HGC-10-21, HGC-20-11, HGC-6-11, HGV-10-11, HGV-10-21, HGV-20-11, HVG-10-11, HVG-10-11UL, HVG-10-21, HVG-10-21UL, HVG-20-11, HVG-20-21, HVG-2-10-11, HVG-2-20-21, MFHVG-10-11, MFHVG-10-21 |                 |                     |

|                    |  |                 |                        |
|--------------------|--|-----------------|------------------------|
| <b>RC circuits</b> |  |                 |                        |
| <b>GEV No.</b>     | 380272   | <b>Ref. No.</b> | 12034748<br>RT30280562 |
| <b>description</b> | RC circuit for contactors type 910-304-585-50 130-250V 50-60Hz conductor 2 connection cable plastic Qty 1 pcs for contactors LS4_LS15K type AEG LR2K A250 type GE BS2R2R |                 |                        |





Зип Общепит

vsezip.ru

+7(812)987-08-81

|   |   |                 |                        |
|---|---|-----------------|------------------------|
|  |   |                 |                        |
| 1   |   |                 |                        |
| <b>GEV No.</b>  | 380177  | <b>Ref. No.</b> | 120548J4<br>RT30350508 |
| <b>description</b>  | RC circuit type 20002 110/220V 50/60/DChz conductor 2 connection cable 230mm L 29mm ømm H 15mm W 20mm adhesive tape plastic Qty 1 pcs |                 |                        |

fuses

fine fuses

|   |   |                 |                     |
|---|---|-----------------|---------------------|
|  |   |                 |                     |
| 1   |   |                 |                     |
| <b>GEV No.</b>  | 358671  | <b>Ref. No.</b> | 12039844<br>R663101 |
| <b>description</b>  | fine fuse size ø5x20mm 1A fast-acting rated 250V Qty 10 pcs   |                 |                     |
| <b>For models:</b>  | HME-10-11, HME-10-21, HME-20-11, HME-20-21, HME-2-10-11, HME-2-20-11, HME-6-11, HMP-10-11, HMP-10-21, HMP-20-11, HMP-20-21, HMP-2-10-11, HMP-6-11 |                 |                     |

|  |  |                 |   |
|--|--|-----------------|---|
|  |  |                 |   |
| 1  |  |                 |   |
| <b>GEV No.</b>   | 358677   | <b>Ref. No.</b> | 12024333<br>12035393<br>P184011<br>RT30190112 |
| <b>description</b>   | fine fuse size ø5x20mm 4A fast-acting rated 250V Qty 10 pcs  |                 |   |
| <b>For models:</b>   | CE-15, CE-9, ECO-160, ECO-1600, ECO-160D, ECO-160I, ECO-200, ECO-200D, ECO-200H, ECO-200HD, ECO-200HI, ECO-200I, ECO-2300, ECO-280D, ECO-280I, ECO-3000, ECO-370D, ECO-370I, ECO-460D, ECO-460I, ECO-550D, ECO-550I, FF-35, FI-160, FI-1600, FI-160AR, FI-160D, FI-160I, FI-200, FI-200AR, FI-200D, FI-200H, FI-200HD, FI-200HI, FI-200I, FI-200W, FI-2300, FI-280D, FI-280I, FI-3000, FI-370D, FI-370I, FI-460D, FI-460I, FI-550D, FI-550I, GA-20, GA-40, HCV-10-11, HCV-10-21... (Other models you can see in the webshop) |                 |   |

|   |   |                 |                        |
|---|---|-----------------|------------------------|
|  |   |                 |                        |
| 1   |   |                 |                        |
| <b>GEV No.</b>  | 358603  | <b>Ref. No.</b> | 12034888<br>RT30190120 |
| <b>description</b>  | fine fuse size ø5x20mm 2A slow-acting rated 250V Qty 10 pcs |                 |                        |

|  |  |                 |                        |
|--|--|-----------------|------------------------|
|  |  |                 |                        |
| 1  |  |                 |                        |
| <b>GEV No.</b>   | 358792   | <b>Ref. No.</b> | 12035115<br>RT40010225 |
| <b>description</b>   | fine fuse size ø6.3x32mm 10A slow-acting rated 250V Qty 10 pcs |                 |                        |

|  |   |                 |                        |
|--|---|-----------------|------------------------|
|  |   |                 |                        |
| 1  |   |                 |                        |
| <b>GEV No.</b>   | 358791  | <b>Ref. No.</b> | 12037374<br>RT40010224 |
| <b>description</b>   | fine fuse size ø6.3x32mm 6.3A slow-acting rated 250V Qty 10 pcs |                 |                        |

fine fuse holders

|   |  |                 |                        |
|---|--|-----------------|------------------------|
|  |  |                 |                        |
| 1   |  |                 |                        |
| <b>GEV No.</b>  | 358382   | <b>Ref. No.</b> | 12035986<br>RT40011295 |
| <b>description</b>  | fuse holder suitable fuse ø5x30mm 10A rated 250V connection screw connection |                 |                        |

|   |  |                 |                     |
|---|--|-----------------|---------------------|
|  |  |                 |                     |
| 1   |  |                 |                     |
| <b>GEV No.</b>  | 550536   | <b>Ref. No.</b> | 12025158<br>R073005 |
| <b>description</b>  | fuse holder suitable fuse ø10x38mm 30A rated 600V  |                 |                     |
| <b>For models:</b>  | ACE-061, ACE-101, ACE-102, ACE-201, ACE-202, ACG-061, ACG-101, ACG-102, ACG-201, ACG-202, AD-120, AD-120B, AD-120BBTDD-UK, AD-120C, AD-120CW, AD-120HY, AD-125, AD-125HRS, AD-125-SOFT, AD-90, AD-90BA, AD-90BBT, AD-90BDD, AD-90DD, ADE-120, ADE-120B, AE-061, AE-061W, AE-101, AE-101W, AE-102, AE-102W, AE-201, AE-202, AG-061, AG-061W, AG-101, AG-101W, AG-102, AG-102W, APE-061, APE-061W, APE-101, APE-101W, APE-102, APE-102W, APE-201, APE-202, APG-061, APG-061W...(Other models you can see in the webshop) |                 |                     |

|   |  |                 |                        |
|---|--|-----------------|------------------------|
|  |  |                 |                        |
| 1   |  |                 |                        |
| <b>GEV No.</b>  | 550348   | <b>Ref. No.</b> | 12033785<br>RT40011283 |
| <b>description</b>  | fuse holder WIELAND type WK4/THSI 6.3 U/V0 suitable fuse ø6.3x32mm 6.3A rated 600V |                 |                        |

1 electric components



# Зип.Общепит

overload switches

vsezip.ru

+7(812)987-08-81

## screw locks

### D0-system (NEOZED)



|                    |   |                 |                        |
|--------------------|---|-----------------|------------------------|
| 1                  |   |                 |                        |
| <b>GEV No.</b>     | 358043  | <b>Ref. No.</b> | 12033846<br>RT30190401 |
| <b>description</b> | fuse size D01 16A rated 250/400V E14 ø 11mm L 36mm Qty 10 pcs |                 |                        |



|                    |   |                 |                        |
|--------------------|---|-----------------|------------------------|
| 1                  |   |                 |                        |
| <b>GEV No.</b>     | 358047  | <b>Ref. No.</b> | 12032709<br>RT30190405 |
| <b>description</b> | fuse size D02 63A rated 250/400V E18 ø 15mm L 36mm Qty 10 pcs |                 |                        |

### gauge pieces (NEOZED)



|                    |                                       |                 |                        |
|--------------------|---------------------------------------|-----------------|------------------------|
| 1                  |                                       |                 |                        |
| <b>GEV No.</b>     | 358064                                | <b>Ref. No.</b> | 12037278<br>RT40011238 |
| <b>description</b> | gauge piece size D02 suitable for 16A |                 |                        |

### fuse holders



|                    |  |                 |                        |
|--------------------|--|-----------------|------------------------|
| 1                  |  |                 |                        |
| <b>GEV No.</b>     | 358060   | <b>Ref. No.</b> | 12032263<br>RT40011234 |
| <b>description</b> | fuse holder suitable fuse D02 3-pole-pole 63A rated 400V |                 |                        |



|                    |  |                 |                        |
|--------------------|--|-----------------|------------------------|
| 1                  |  |                 |                        |
| <b>GEV No.</b>     | 358061   | <b>Ref. No.</b> | 12036497<br>RT40011235 |
| <b>description</b> | fuse holder suitable fuse D02 ø 25mm mounting ø 18mm rated 400V L 30mm |                 |                        |



|                    |   |                 |                        |
|--------------------|---|-----------------|------------------------|
| 1                  |   |                 |                        |
| <b>GEV No.</b>     | 358524                                  | <b>Ref. No.</b> | 12033449<br>RT30140402 |
| <b>description</b> | overload switch drop-away current 0.05A |                 |                        |

## electric accessories

### cables

#### accessories

#### protection hoses

#### JOHN GUEST



|                    |  |                 |                     |
|--------------------|--|-----------------|---------------------|
| 1                  |  |                 |                     |
| <b>GEV No.</b>     | 550788   | <b>Ref. No.</b> | 12008694<br>X033027 |
| <b>description</b> | screw connection ID ø 14mm for protection hose plastic Qty 1 pcs thread PG11   |                 |                     |
| <b>For models:</b> | FE7-05-1C, FE7-05-2C, FE-710, FE7-10-2C, FE7-10-4C, FE-71-15, FE-720, FE9-05, FE9-05-1C, FE9-05-2C, FE9-05AD, FE9-05PLUS, FE9-05PLUS-S, FE9-05S, FE9-05S-1C, FE9-05S-2C, FE9-05S-AD, FE9-05USMC, FE9-10, FE9-10-2C, FE9-10-4C, FE9-10AD, FE9-10PLUS, FE-91-20, FE-920, FG-710, FG-720, FI-200W |                 |                     |

#### miscellaneous



|                    |   |                 |                     |
|--------------------|---|-----------------|---------------------|
| 1                  |   |                 |                     |
| <b>GEV No.</b>     | 550787  | <b>Ref. No.</b> | 11000146<br>3712300 |
| <b>description</b> | protection pipe ID ø 23mm ED ø 28mm Qty 1m plastic for cable  |                 |                     |
| <b>For models:</b> | ECO-120, ECO-120B, ECO-160, ECO-160D, ECO-160I, ECO-200, ECO-200D, ECO-200H, ECO-200HD, ECO-200HI, ECO-200I, ECO-2700D, ECO-2700I, ECO-280D, ECO-280I, ECO-370D, ECO-370I, ECO-4000D, ECO-4000I, ECO-460D, ECO-460I, ECO-550D, ECO-550I, ECO-6000D, ECO-6000I, FE7-05-1C, FE7-05-2C, FE-710, FE7-10-2C, FE7-10-4C, FE-720, FE9-05, FE9-05-1C, FE9-05-2C, FE9-05AD, FE9-05PLUS, FE9-05PLUS-S, FE9-05S, FE9-05S-1C, FE9-05S-2C, FE9-05S-AD, FE9-05USMC, FE9-10, FE9-10-2C, FE9-10-4C, FE9-10AD, FE9-10PLUS, FI-160, FI-160AR, FI-160D...(Other models you can see in the webshop) |                 |                     |

#### cable glands

#### cable glands



|                    |  |                 |            |
|--------------------|--|-----------------|------------|
| 1                  |  |                 |            |
| <b>GEV No.</b>     | 551102   | <b>Ref. No.</b> | 6003010082 |
| <b>description</b> | cable gland ID ø 10mm mounting ø 12mm Neoprene -30 up to +120°C Qty 1 pcs  |                 |            |
| <b>For models:</b> | ATM-031, ATM-031-60Hz, ATM-051VCH, ATM-051VCH-60Hz, ATM-081VCH, ATM-081VCH-60Hz, ATM-101VCH, ATM-101VCH-60Hz, ATM-121VCH, ATM-121VCH-60Hz, ATM-121VCHP, ATM-161VCH |                 |            |



Зип Общепит  
vsezip.ru  
(812)987-08-81

|   |  |                 |                        |
|---|--|-----------------|------------------------|
|  |  |                 |                        |
| 1   |  |                 |                        |
| <b>GEV No.</b>  | 550998   | <b>Ref. No.</b> | 12037670<br>RT20220111 |
| <b>description</b>  | cable gland ID ø 2.5mm mounting ø 7mm rubber Qty 5 pcs |                 |                        |

|   |   |                 |                     |
|---|---|-----------------|---------------------|
|  |   |                 |                     |
| 1   |   |                 |                     |
| <b>GEV No.</b>  | 550311  | <b>Ref. No.</b> | 12018128<br>N023064 |
| <b>description</b>  | cable gland ID ø 6mm mounting ø 9mm ED ø 14mm Neoprene -30 up to +90°C Qty 10 pcs   |                 |                     |
| <b>For models:</b>  | ECO-120, ECO-120B, FI-100, FI-100AR, FI-100B, FI-120, FI-120B, FI-120W, FI-30, FI-48, FI-48B, FI-48W, FI-50, FI-64, FI-64B, FI-64W, FI-72, MF-120, MF-48, MF-64 |                 |                     |

threaded cable glands

screw connections

|  |   |                 |                     |
|--|---|-----------------|---------------------|
|  |   |                 |                     |
| 1  |   |                 |                     |
| <b>GEV No.</b>   | 550971  | <b>Ref. No.</b> | 12009963<br>R013022 |
| <b>description</b>   | cable gland thread PG16 cable ø 14mm mounting ø 22.5mm Qty 1 pcs plastic WS 27  |                 |                     |
| <b>For models:</b>   | ACE-061, AE-061, AE-061W, APE-061, APE-061W, BME7-05, BME7-10, BME9-05, BME9-10, CGE6-41, FTE7-05, FTE7-05L, FTE7-05R, FTE9-05L, FTE9-05L-AD, FTE9-05PLUS-CL, FTE9-05PLUS-CR, FTE9-05PLUS-L, FTE9-05PLUS-R, FTE9-05R, FTE9-05R-AD, FTEC7-05L, FTEC9-05, FTEC9-05L, FTEC9-05L-AD, FTEC9-05R, FTEC9-05R-AD, FTEC9-05USMC, HCG-10-11, HCG-10-21, HCG-2-10-11, HCV-6-11, HE-6-11, HMG-10-11, HMG-10-21, HMG-2-10-11, HMM-6-11 |                 |                     |

fastening nuts

|   |   |                 |                     |
|---|---|-----------------|---------------------|
|  |   |                 |                     |
| 1   |   |                 |                     |
| <b>GEV No.</b>  | 550578  | <b>Ref. No.</b> | 12009764<br>Q223016 |
| <b>description</b>  | nut thread PG21 H 4.6mm WS 32 nickel-plated brass Qty 1 pcs mounting ømm cable ømm  |                 |                     |
| <b>For models:</b>  | ECO-120, ECO-120B, FI-100, FI-100AR, FI-100B, FI-120, FI-120B, FI-120W, FI-30, FI-48, FI-48B, FI-48W, FI-50, FI-64, FI-64B, FI-64W, FI-72, FI-80, FI-80W, LA-13M, LA-18MP, LA-AC-10M, LA-AC-10MA, LA-AC-10MP, LA-AC-13M, LA-AC-13MA, LA-AC-13MP, LA-AC-18M, LA-AC-18MA, LA-AC-18MP, LA-AC-25M, LA-AC-25MA, LA-AC-25MP, LA-E-10M, LA-E-10MA, LA-E-10MP, LA-E-13M, LA-E-13MA, LA-E-13MP, LA-E-18M, LA-E-18MA, LA-E-18MP, LA-E-25M, LA-E-25MA, LA-E-25MP, LA-V-10M, LA-V-10MP, LA-V-13M, LA-V-13MP, LA-V-18M...(Other models you can see in the webshop) |                 |                     |

|  |   |                 |                     |
|--|---|-----------------|---------------------|
|  |   |                 |                     |
| 1  |   |                 |                     |
| <b>GEV No.</b>   | 550974  | <b>Ref. No.</b> | 12010063<br>R023025 |
| <b>description</b>   | nut thread PG21 WS 32 plastic Qty 1 pcs thickness 7.5mm mounting ømm cable ømm  |                 |                     |
| <b>For models:</b>   | ACE-061, ACE-101, AE-061, AE-101, AE-101W, APE-061, APE-101, APE-101W, CE9-20, CE9-20AD, CE9-20PLUS, CE9-40, CE9-40AD, CE9-40PLUS, CE9-41, CGE9-41, COE-061, CPE7-05, CPE7-05NC, CPE9-05, CPE9-05AD, CPE9-05AD-S, CPE9-05NC, CPE9-05PLUS, CPE9-05PLUS-S, CPE9-05S, CPE9-05SNC, CPG9-05, CPG9-05NC, CPG9-05S, CPG9-05SNC, ECO-160, ECO-160D, ECO-160I, ECO-200, ECO-200D, ECO-200H, ECO-200HD, ECO-200HI, ECO-200I, ECO-2700D, ECO-2700I, ECO-280D, ECO-280I, ECO-370D, ECO-370I, ECO-4000D, ECO-4000I, ECO-460D, ECO-460I...(Other models you can see in the webshop) |                 |                     |

ribbon cables

group 1

|  |  |                 |                     |
|--|--|-----------------|---------------------|
|  |  |                 |                     |
| 1  |  |                 |                     |
| <b>GEV No.</b>   | 402970   | <b>Ref. No.</b> | 12034267<br>EU41523 |
| <b>description</b>   | ribbon cable 10-pole L 1200mm plug type 2 row coded Qty 1m |                 |                     |

|  |   |                 |                     |
|--|---|-----------------|---------------------|
|  |   |                 |                     |
| 1  |   |                 |                     |
| <b>GEV No.</b>   | 400878  | <b>Ref. No.</b> | 12020200<br>R663102 |
| <b>description</b>   | ribbon cable 26-pole L 100mm plug type FC-26P raster size 2.54mm  |                 |                     |
| <b>For models:</b>   | HME-10-11, HME-10-21, HME-20-11, HME-20-21, HME-2-10-11, HME-2-20-11, HME-6-11, HMP-10-11, HMP-10-21, HMP-20-11, HMP-20-21, HMP-2-10-11, HMP-6-11 |                 |                     |

cable harnesses

|   |   |                 |  |
|---|---|-----------------|--|
|  |   |                 |  |
| 1   |   |                 |  |
| <b>GEV No.</b>  | 550774  | <b>Ref. No.</b> | 12018040<br>12018658<br>T113037<br>T113075 |
| <b>description</b>  | cable harness   |                 |  |
| <b>For models:</b>  | HVG-10-11, HVG-10-11UL, HVG-10-21, HVG-10-21UL, HVG-2-10-11, MFHVG-10-11, MFHVG-10-21 |                 |  |

|   |                              |                 |         |
|---|------------------------------|-----------------|---------|
|  |                              |                 |         |
| 1   |                              |                 |         |
| <b>GEV No.</b>  | 691855                       | <b>Ref. No.</b> | Z743001 |
| <b>description</b>  | cable harness for dishwasher |                 |         |



Зип-Общепит

terminals and connectors

miscellaneous

1

|                    |  |                 |                     |
|--------------------|--|-----------------|---------------------|
| <b>GEV No.</b>     | 550773   | <b>Ref. No.</b> | 12018558<br>T113036 |
| <b>description</b> | connecting cable L 1.9m  |                 |                     |
| <b>For models:</b> | HCG-10-11, HCG-10-21, HCG-2-10-11, HCG-6-11, HGC-10-11, HGC-11, HGV-10-11, HVG-10-11, HVG-10-21, HVG-2-10-11 |                 |                     |

connection cables



|                    |   |                 |                        |
|--------------------|---|-----------------|------------------------|
| <b>GEV No.</b>     | 403815                                    | <b>Ref. No.</b> | 12033832<br>RT88171040 |
| <b>description</b> | connection cable 9-pole RS232/USB L 790mm |                 |                        |



|                    |   |                 |                       |
|--------------------|---|-----------------|-----------------------|
| <b>GEV No.</b>     | 403812  | <b>Ref. No.</b> | 12032677<br>RT4000235 |
| <b>description</b> | connection cable L 1500mm 8-pole for combi-steamer suitable for SCC Linie 202 connection plug-in connection |                 |                       |



|                    |   |                 |                        |
|--------------------|---|-----------------|------------------------|
| <b>GEV No.</b>     | 403811  | <b>Ref. No.</b> | 12033169<br>RT87201302 |
| <b>description</b> | connection cable L 525mm 7-pole for combi-steamer CPC-Linie CPC/CM 61-202 connection plug-in connection plug type coded for PCB |                 |                        |



|                    |   |                 |                       |
|--------------------|---|-----------------|-----------------------|
| <b>GEV No.</b>     | 579001  | <b>Ref. No.</b> | 12035183<br>RT4000472 |
| <b>description</b> | data cable L 1300mm 8-pole suitable for RATIONAL plug type RJ45 |                 |                       |



|                    |  |                 |                        |
|--------------------|--|-----------------|------------------------|
| <b>GEV No.</b>     | 579005   | <b>Ref. No.</b> | 12034255<br>RT87201300 |
| <b>description</b> | data cable L 550mm 4-pole for combi-steamer suitable for CPC-Linie CPC/CM 61-202 plug type USB |                 |                        |



|                    |  |                 |                       |
|--------------------|--|-----------------|-----------------------|
| <b>GEV No.</b>     | 579002   | <b>Ref. No.</b> | 12035364<br>RT4000471 |
| <b>description</b> | data cable L 800mm 8-pole for combi-steamer suitable for SCC Line plug type RJ45 |                 |                       |

not insulated

female fastons

iron nickel-plated

+7(812)987-08-81



|                    |   |                 |                        |
|--------------------|---|-----------------|------------------------|
| <b>GEV No.</b>     | 550001  | <b>Ref. No.</b> | 12034541<br>RT40020100 |
| <b>description</b> | female faston size 6.3x0.8mm 1.0-2.5mm <sup>2</sup> straight Fe gal Ni t.max. 340°C Qty 100 pcs |                 |                        |

terminals

terminal blocks



|                    |   |                 |                     |
|--------------------|---|-----------------|---------------------|
| <b>GEV No.</b>     | 550239  | <b>Ref. No.</b> | 12025086<br>Z743006 |
| <b>description</b> | lustre terminal 12-pole cross section 16mm <sup>2</sup> max. 75A max 500V temp.-resist. 150°C |                 |                     |
| <b>For models:</b> | AD-90, AD-90DD, ADE-120, ADE-120B, ECO-120, ECO-120B, FI-80, FI-80AR, FI-80BBT-UK, FI-80W     |                 |                     |

connection terminals with screw/faston connections



|                    |  |                 |                     |
|--------------------|--|-----------------|---------------------|
| <b>GEV No.</b>     | 505212   | <b>Ref. No.</b> | 12024110<br>Z603025 |
| <b>description</b> | power terminal block 2-pole max. 20A max 600V connection ø2.5mm <sup>2</sup> / F6.3 temp.-resist. 150°C cross section 4mm <sup>2</sup>   |                 |                     |
| <b>For models:</b> | AD-15, AD-15D, AD-20C-UK, AD-21, AD-21B, AD-21BDD, AD-21C, AD-21D, AD-21DD, AD-21W, AD-505, AD-505-SOFT, CG-210G, CG-310G, CO-500, CO-500B, CO-500BDD, CO-500DD, CO-501, CO-501B, CO-501BDD, CO-501DD, CO-501-SOFT, CO-502B, CO-502BDD, CO-502DD, CO-502W, COP-503, COP-503B, COP-503BDD, COP-503DD, COP-503-SOFT, COP-504, COP-504B, COP-504BDD, COP-504DD, COP-504W, LVC-12, LVC-15, LVC-15D, LVC-21, LVC-21B, LVC-21C, LVC-21D, LVC-21W, LVR-10, LVR-14, LVR-14D, LVR-20, LVR-20B...(Other models you can see in the webshop) |                 |                     |



Зип Общежит  
rail-mounted terminals

vsezip.ru  
rail-mounted terminals

+7(812)987-08-81

electric components

|  |   |                 |                     |
|--|---|-----------------|---------------------|
|  <p>1</p> |   |                 |                     |
| <b>GEV No.</b>   | 550278  | <b>Ref. No.</b> | 12024382<br>U183046 |
| <b>description</b>   | power terminal block 3-pole max. 40A max 400V connection ø6mm <sup>2</sup> / F6.3 temp.-resist. 150°C cross section 6mm <sup>2</sup>  |                 |                     |
| <b>For models:</b>   | BME6-05, BME7-05, BME9-05, BME9-05AD, BME9-05PLUS, BME9-05V-T, CE-410, CO-350, CO-350-B, CO-350-B-DD, CO-350-COLD, CO-350-COLD-B, CO-350-COLD-B-DD, CO-350-COLD-DD, CO-350-DD, CO-352-COLD, CO-352-COLD-B, CO-352-COLD-B-DD, CO-352-COLD-DD, CO-400, CO-400-B, CO-400-B-DD, CO-400-COLD, CO-400-COLD-B, CO-400-COLD-B-DD, CO-400-COLD-DD, CO-400-DD, CO-400-SOFT, CO-402-COLD, CO-402-COLD-B, CO-402-COLD-B-DD, CO-402-COLD-DD, CO-402W, CPG9-05, CPG9-05NC, CPG9-05S, CPG9-05SNC, CV6-20, CV6-40, FE-4, FG7-05-1C, FG7-05-2C, FG-710, FG7-10-2C, FG7-104C, FG7-10-4C, FG-720, FG9-05, FG9-05-1C, FG9-05-2C...(Other models you can see in the webshop) |                 |                     |

|  |   |                 |                     |
|--|---|-----------------|---------------------|
|  <p>1</p> |   |                 |                     |
| <b>GEV No.</b>   | 550792  | <b>Ref. No.</b> | 12024229<br>Z103029 |
| <b>description</b>   | rail-mounted terminal 2.5mm <sup>2</sup> for DIN rail 35mm grey 1-pole  |                 |                     |
| <b>For models:</b>   | ECO-160, ECO-1600, ECO-160D, ECO-160I, ECO-200, ECO-200D, ECO-200H, ECO-200HD, ECO-200HI, ECO-200I, ECO-2300, ECO-2700D, ECO-2700I, ECO-280D, ECO-280I, ECO-280I, ECO-3000, ECO-370D, ECO-370I, ECO-4000D, ECO-4000I, ECO-460D, ECO-460I, ECO-550D, ECO-550I, ECO-6000D, ECO-6000I, FI-160, FI-1600, FI-160AR, FI-160D, FI-160I, FI-200, FI-200AR, FI-200D, FI-200H, FI-200HD, FI-200HI, FI-200I, FI-200W, FI-200WL, FI-200WR, FI-2300, FI-2700D, FI-2700I, FI-280D, FI-280I, FI-3000, FI-370D, FI-370I, FI-4000D...(Other models you can see in the webshop) |                 |                     |

|  |  |                 |   |
|--|--|-----------------|---|
|  <p>2</p> |  |                 |   |
| <b>GEV No.</b>   | 550411   | <b>Ref. No.</b> | 12025183<br>12034943<br>EU220011<br>R253044 |
| <b>description</b>   | power terminal block 6-pole max. 40A max 450V connection ø6mm <sup>2</sup> / F6.3 temp.-resist. 150°C cross section 6mm <sup>2</sup>   |                 |   |
| <b>For models:</b>   | AD-45BBT, AD-48, AD-48B, AD-48BDD, AD-48C, AD-48D, AD-48DD, AD-48HY, AD-48W, AD-505, AD-505-SOFT, AD-64, AD-64B, AD-64BBT, AD-64BDD, AD-64BTDD, AD-64C, AD-64CW, AD-64D, AD-64DD, AD-64HY, AD-72, AD-72W, BME7-10, BME9-10, BME9-10AD, BME9-10PLUS, BME9-10V-T, CE6-20, CE6-40, CE6-41, CE7-20, CE7-20Q, CE7-40, CE7-40Q, CE7-41, CE7-41Q, CGE6-41, CGE7-231, CI9-20AD, CI9-20PLUS, CI9-40AD, CI9-40PLUS, CMF6-05, CO-500, CO-500B, CO-500BDD, CO-500DD, CO-501, CO-501B...(Other models you can see in the webshop) |                 |   |

|  |   |                 |                     |
|--|---|-----------------|---------------------|
|  <p>1</p> |   |                 |                     |
| <b>GEV No.</b>   | 551230  | <b>Ref. No.</b> | 12024942<br>R143011 |
| <b>description</b>   | rail-mounted terminal 70mm <sup>2</sup> for DIN rail 35mm grey 1-pole   |                 |                     |
| <b>For models:</b>   | ACE-202, AE-202, APE-202, COE-202, ECO-280D, ECO-280I, ECO-370D, ECO-370I, ECO-460D, ECO-460I, ECO-550D, ECO-550I, FI-160, FI-160AR, FI-160D, FI-160I, FI-200, FI-200AR, FI-200D, FI-200H, FI-200HD, FI-200HI, FI-200I, FI-200W, FI-200WL, FI-200WR, FI-2700D, FI-2700I, FI-280D, FI-280I, FI-370D, FI-370I, FI-4000D, FI-4000I, FI-460D, FI-460I, FI-550D, FI-550I, FI-6000D, FI-6000I, HEI-20-21, HEM-20-21, HEP-20-21, HME-20-21, HME-2-20-11, HMM-20-21, HMM-20-21UL, HMM-40-11-USMC, HMP-20-21, VE-202...(Other models you can see in the webshop) |                 |                     |

|   |   |                 |                     |
|---|---|-----------------|---------------------|
| <p>PCB terminal blocks</p>  <p>1</p> |   |                 |                     |
| <b>GEV No.</b>  | 550779  | <b>Ref. No.</b> | 12019476<br>R663043 |
| <b>description</b>  | PCB terminal block 2-pole raster size 5mm PCB   |                 |                     |
| <b>For models:</b>  | HCG-10-11, HCG-10-21, HCG-2-10-11, HCG-6-11, HME-20-11, HMG-10-11, HMG-10-11UL, HMG-10-21, HMG-10-21UL, HMG-2-10-11, HMG-6-11, HMI-10-11, HMI-10-11UL, HMI-10-21, HMI-10-21UL, HMI-2-10-11, HMI-6-11, HMI-6-11UL, HMM-10-11, HMM-10-11UL, HMM-10-21, HMM-10-21UL, HMM-20-11, HMM-20-11UL, HMM-20-21, HMM-2-10-11, HMM-6-11, HMM-6-11UL, HMP-20-11 |                 |                     |

|  |   |                 |                     |
|--|---|-----------------|---------------------|
| <p>accessories</p>  <p>1</p> |   |                 |                     |
| <b>GEV No.</b>   | 550789  | <b>Ref. No.</b> | 12024199<br>Z263303 |
| <b>description</b>   | rail-mounted terminal grey for DIN rail 35mm  |                 |                     |
| <b>For models:</b>   | ACG-061, ACG-101, ACG-102, ACG-201, ACG-202, AD-125, AD-125HRS, AD-125-SOFT, AG-061, AG-061W, AG-101, AG-101W, AG-102, AG-102W, AG-201, AG-202, APG-061, APG-061W, APG-101, APG-101W, APG-102, APG-102W, APG-201, APG-202, CE6-20, CE6-40, CE6-41, CE7-20, CE7-20Q, CE7-40, CE7-40Q, CE7-41, CE9-20, CE9-20AD, CE9-20PLUS, CGE6-41, CGE7-211, CGE7-41, CGE7-41H, CGE9-11, CGE9-41, CGE9-41AD, CGE9-41PLUS, CO-110, CO-110B, CO-110BDD, CO-110DD, CO-112, CO-112B, CO-112BDD...(Other models you can see in the webshop) |                 |                     |



Зип Общепит

vsezip.ru

+7(812)987-08-81

## WIELAND

## rail-mounted terminals type 9700A



1

|                    |   |                 |   |
|--------------------|---|-----------------|---|
| <b>GEV No.</b>     | 550374  | <b>Ref. No.</b> | 12025191<br>12035926<br>RT40011250<br>Z683097 |
| <b>description</b> | rail-mounted terminal WIELAND type 9700A/10 S35 1.5-16mm <sup>2</sup> top-hat rail 35mm blue W 10mm L 49mm  |                 |   |
| <b>For models:</b> | AD-120, AD-120B, AD-120BBTDD-UK, AD-120C, AD-120HY, AD-90, AD-90BA, AD-90BBT, AD-90BDD, AD-90DD, ADE-120, ADE-120B, CE6-20, CE6-40, CE6-41, CE7-41, CE9-40, FE9-05, FE9-05-1C, FE9-05-2C, FE9-05AD, FE9-05PLUS, FE9-05PLUS-S, FE9-05S, FE9-05S-1C, FE9-05S-2C, FE9-05S-AD, FE9-05USMC, FE9-10, FE9-10-2C, FE9-10-4C, FE9-10AD, FE9-10PLUS, FE-920, FI-100, FI-100AR, FI-100B, FI-100BBT-UK, FI-120, FI-1200, FI-120AR+DD, FI-120B, FI-120C, FI-120HY-CLINIC, FI-120W, FI-80BBT-UK, FI-80W, FI-900, FI-E-100, FTE9-10L...(Other models you can see in the webshop) |                 |   |

|                    |  |                 |                        |
|--------------------|--|-----------------|------------------------|
| <b>GEV No.</b>     | 550377   | <b>Ref. No.</b> | 12034956<br>RT40011252 |
| <b>description</b> | rail-mounted terminal WIELAND type 9700A/16 S35 2.5-35mm <sup>2</sup> top-hat rail 35mm blue W 16mm L 59mm |                 |                        |

|                    |  |                 |                        |
|--------------------|--|-----------------|------------------------|
| <b>GEV No.</b>     | 550376   | <b>Ref. No.</b> | 12034955<br>RT40011206 |
| <b>description</b> | rail-mounted terminal WIELAND type 9700A/16 S35 2.5-35mm <sup>2</sup> top-hat rail 35mm grey W 16mm L 59mm |                 |                        |



1

|                    |  |                 |   |
|--------------------|--|-----------------|---|
| <b>GEV No.</b>     | 550373   | <b>Ref. No.</b> | 12025214<br>12035988<br>RT40011202<br>Z683069 |
| <b>description</b> | rail-mounted terminal WIELAND type 9700A/10 S35 1.5-16mm <sup>2</sup> top-hat rail 35mm grey W 10mm L 49mm   |                 |   |
| <b>For models:</b> | AD-120, AD-120B, AD-120BBTDD-UK, AD-120C, AD-120HY, AD-90, AD-90BA, AD-90BBT, AD-90BDD, AD-90DD, ADE-120, ADE-120B, CE-410, CE9-40, CE9-41, CE9-41AD, CE9-41PLUS, FE9-05, FE9-05-1C, FE9-05-2C, FE9-05AD, FE9-05PLUS, FE9-05PLUS-S, FE9-05S, FE9-05S-1C, FE9-05S-2C, FE9-05S-AD, FE9-05USMC, FE9-10, FE9-10-2C, FE9-10-4C, FE9-10AD, FE9-10PLUS, FE-920, FI-100, FI-100AR, FI-100B, FI-100BBT-UK, FI-120, FI-1200, FI-120AR+DD, FI-120B, FI-120C, FI-120HY-CLINIC, FI-120W, FI-650R, FI-80BBT-UK, FI-80W, FI-900, FI-E-100...(Other models you can see in the webshop) |                 |   |

|                    |  |                 |                        |
|--------------------|--|-----------------|------------------------|
| <b>GEV No.</b>     | 550378   | <b>Ref. No.</b> | 12033543<br>RT40011233 |
| <b>description</b> | rail-mounted terminal WIELAND type 9700A/16 SL2 S35 2.5-35mm <sup>2</sup> top-hat rail 35mm yellow/green W 16mm L 53mm |                 |                        |

|                    |   |                 |                        |
|--------------------|---|-----------------|------------------------|
| <b>GEV No.</b>     | 550371  | <b>Ref. No.</b> | 12036964<br>RT40011216 |
| <b>description</b> | rail-mounted terminal WIELAND type 9700A/6 S35 0.5-4mm <sup>2</sup> top-hat rail 35mm grey W 6mm L 46.6mm |                 |                        |



1

|                    |  |                 |                     |
|--------------------|--|-----------------|---------------------|
| <b>GEV No.</b>     | 550375   | <b>Ref. No.</b> | 12023727<br>Z683070 |
| <b>description</b> | rail-mounted terminal WIELAND type 9700A/10 SL2 S35 1.5-16mm <sup>2</sup> top-hat rail 35mm yellow/green W 10mm L 53mm   |                 |                     |
| <b>For models:</b> | AD-120, AD-120B, AD-120BBTDD-UK, AD-120C, AD-120CW, AD-120HY, AD-90, AD-90BA, AD-90BBT, AD-90BDD, AD-90DD, ADE-120, ADE-120B, CE-410, CE9-40, FE9-05, FE9-05-1C, FE9-05-2C, FE9-05AD, FE9-05PLUS, FE9-05PLUS-S, FE9-05S, FE9-05S-1C, FE9-05S-2C, FE9-05S-AD, FE9-05USMC, FE9-10, FE9-10-2C, FE9-10-4C, FE9-10AD, FE9-10PLUS, FE-920, FI-100, FI-100AR, FI-100B, FI-100BBT-UK, FI-120, FI-1200, FI-120AR+DD, FI-120B, FI-120C, FI-120HY-CLINIC, FI-120W, FI-650R, FI-80BBT-UK, FI-80W, FI-900, FI-E-100, FTE9-10L, FTE9-10L+R...(Other models you can see in the webshop) |                 |                     |

|                    |   |                 |                        |
|--------------------|---|-----------------|------------------------|
| <b>GEV No.</b>     | 550372  | <b>Ref. No.</b> | 12035662<br>RT40011222 |
| <b>description</b> | rail-mounted terminal WIELAND type 9700A/6 SL2 S35 0.5-4mm <sup>2</sup> top-hat rail 35mm yellow/green W 6mm L 48.5mm |                 |                        |





Зип Общепит

DIN rails

vsezip.ru

+7(812)987-08-81

electric components

|   |   |                 |                     |
|---|---|-----------------|---------------------|
|  |   |                 |                     |
| <b>GEV No.</b>  | 550381  | <b>Ref. No.</b> | 12023373<br>P453025 |
| <b>description</b>  | rail-mounted terminal WIELAND type 9700A/8 S35 1.0-10mm <sup>2</sup> top-hat rail 35mm grey W 8mm L 46.6mm  |                 |                     |
| <b>For models:</b>  | ACE-061, AD-125, AD-125HRS, AD-125-SOFT, AE-061, AE-061W, APE-061, APE-061W, CE6-20, CE6-40, CE6-41, CE7-20, CE7-20Q, CE7-40, CE7-40Q, CE7-41, CE9-20, CE9-20AD, CE9-20PLUS, CGE6-41, CGE7-208, CGE7-41, CGE7-41H, CGE9-11, CGE9-41, CGE9-41AD, CGE9-41PLUS, CO-110, CO-110B, CO-110BDD, CO-110DD, CO-112, CO-112B, CO-112BDD, CO-112DD, CO-142W, CO-142WDD, CO-170, CO-170B, CO-170BDD, CO-170DD, CO-170HRS, CO-170HRSDD, CO-170HRS-SOFT, CO-170-SOFT, CO-172, CO-172B, CO-172BDD, CO-172DD, COE-061...(Other models you can see in the webshop) |                 |                     |

|   |   |                 |                     |
|---|---|-----------------|---------------------|
|  |   |                 |                     |
| <b>GEV No.</b>  | 551017  | <b>Ref. No.</b> | 12022603<br>Z103084 |
| <b>description</b>  | DIN rail W 35mm L 138mm hole distance 118mm   |                 |                     |
| <b>For models:</b>  | COE-102, ECO-1600, ECO-2300, ECO-3000, FI-1600, FI-2300, FI-3000, FI-48, FI-48B, FI-48W, FI-50, FI-64, FI-64B, FI-64W, FI-72, HEI-10-21, HEM-10-11, HEM-10-21, HEM-20-11, HEM-6-11, HEP-10-11, HEP-10-21, HEP-20-11, HEP-6-11, HGC-10-21, HGP-10-21, HGV-10-21, HME-10-11, HME-10-21, HME-20-11, HME-2-10-11, HME-6-11, HMM-10-11, HMM-10-11UL, HMM-10-21, HMM-10-21UL, HMM-20-11, HMM-20-11UL, HMM-2-10-11, HMM-6-11, HMM-6-11UL, HMP-10-11, HMP-10-21, HMP-20-11, HMP-2-10-11, HMP-6-11, LC-AC-10, LC-AC-10A, LC-AC-14, LC-AC-14A...(Other models you can see in the webshop) |                 |                     |

|   |   |                 |                        |
|---|---|-----------------|------------------------|
| fuse terminal blocks  |   |                 |                        |
|  |   |                 |                        |
| <b>GEV No.</b>  | 550348  | <b>Ref. No.</b> | 12033785<br>RT40011283 |
| <b>description</b>  | fuse holder WIELAND type WK4/THSI 6.3 U/V0 suitable fuse ø6.3x-32mm 6.3A rated 600V |                 |                        |

|   |   |                 |                     |
|---|---|-----------------|---------------------|
|  |   |                 |                     |
| <b>GEV No.</b>  | 551016  | <b>Ref. No.</b> | 12022790<br>Z123018 |
| <b>description</b>  | DIN rail W 35mm L 55mm hole distance 35mm   |                 |                     |
| <b>For models:</b>  | CE6-41, CE7-41, CGE6-41, CGE7-220, CGE7-41, CGE7-41H, CMF6-05, COE-102, COE-202, CPE6-05, ECO-1600, ECO-2300, ECO-3000, FE6-05, FE6-05TE, FE6-10, FE6-10TE, FI-1600, FI-2300, FI-30, FI-3000, FI-30AR+DD, FI-30B-BT-UK, FI-30-UK, FI-48, FI-48B, FI-48B-BT-UK, FI-48D, FI-48HY-CLINIC, FI-48W, FI-50, FI-64W, FTE6-05L, FTE6-05R, FTE6-10L, FTE6-10L+R, FTE6-10R, FTE7-05, FTE7-05L, FTE7-05R, FTE7-10, FTE7-10L, FTE7-10L+R, FTE7-10R, FTE9-05L, FTE9-05L-AD, FTE9-05PLUS-CL, FTE9-05PLUS-CR, FTE9-05PLUS-L, FTE9-05PLUS-R...(Other models you can see in the webshop) |                 |                     |

|   |  |                 |                        |
|---|--|-----------------|------------------------|
| accessories   |  |                 |                        |
|  |  |                 |                        |
| <b>GEV No.</b>  | 550370   | <b>Ref. No.</b> | 12036737<br>RT40011203 |
| <b>description</b>  | terminal block end bracket clampsmm <sup>2</sup> |                 |                        |

|   |   |                 |                     |
|---|---|-----------------|---------------------|
|  |   |                 |                     |
| <b>GEV No.</b>  | 551018  | <b>Ref. No.</b> | 12022528<br>Z103083 |
| <b>description</b>  | DIN rail W 35mm L 72mm hole distance 52mm   |                 |                     |
| <b>For models:</b>  | ACE-061, ACE-101, ACE-102, ACE-201, ACE-202, AD-120, AD-120B, AD-120BBTDD-UK, AD-120C, AD-120CW, AD-120HY, AD-90, AD-90BA, AD-90BBT, AD-90BDD, AD-90DD, ADE-120, ADE-120B, AE-061, AE-101, AE-102, AE-201, AE-202, APE-061, APE-101, APE-102, APE-201, APE-202, CE6-20, CE6-40, CE6-41, CE7-20, CE7-20Q, CE7-40, CE7-40Q, CE7-41, CE7-41Q, CE9-20, CE9-40, CGE6-41, CGE7-207, CGE7-41, CGE7-41H, ECO-120, ECO-120B, ECO-1600, ECO-2300, ECO-3000, FF-35, FI-100...(Other models you can see in the webshop) |                 |                     |

|   |   |                 |  |
|---|---|-----------------|--|
| accessories   |   |                 |  |
| marking labels  |   |                 |  |
|  |   |                 |  |
| <b>GEV No.</b>  | 505000  | <b>Ref. No.</b> | 12017607<br>12023957<br>Z213005<br>Z743005 |
| <b>description</b>  | signboard R/S/T/N   |                 |  |
| <b>For models:</b>  | AD-45BBT, AD-48, AD-48B, AD-48BDD, AD-48C, AD-48D, AD-48DD, AD-48HY, AD-48W, AD-64, AD-64B, AD-64BBT, AD-64BDD, AD-64BTDD, AD-64C, AD-64CW, AD-64D, AD-64DD, AD-64HY, AD-72, AD-72W, ECO-120, ECO-120B, FI-48, FI-48AR, FI-48B, FI-48B-BT-UK, FI-48C, FI-48D, FI-48HY-CLINIC, FI-48W, FI-50, FI-60DD, FI-64, FI-64AR, FI-64B, FI-64B-BT-UK, FI-64C, FI-64D, FI-64HY-CLINIC, FI-64W, FI-72, FI-72AR, FI-72W, FI-80, FI-80W, MF-48, MF-64 |                 |  |

Зип.Общепит  
gas taps

## electronic magnets



1

|                    |  |                 |                     |
|--------------------|--|-----------------|---------------------|
| <b>GEV No.</b>     | 691059   | <b>Ref. No.</b> | 12017119<br>R663030 |
| <b>description</b> | lifting magnet 230V voltage AC 50/60Hz duty cycle 100% 0.1A  |                 |                     |
| <b>For models:</b> | HEI-10-11, HEI-20-11, HEI-6-11, HEM-10-11, HEM-20-11, HEM-6-11, HEP-10-11, HEP-20-11, HEP-6-11, HME-10-11, HME-10-21, HME-20-11, HME-20-21, HME-2-10-11, HME-2-20-11, HME-6-11, HMI-10-11, HMI-10-11UL, HMI-10-21, HMI-10-21UL, HMI-2-10-11, HMI-6-11, HMI-6-11UL, HMM-10-11, HMM-10-11UL, HMM-10-21, HMM-10-21UL, HMM-20-11, HMM-20-11UL, HMM-20-21, HMM-20-21UL, HMM-2-10-11, HMM-2-20-11, HMM-40-11-USMC, HMM-6-11, HMM-6-11UL, HMP-10-11, HMP-10-21, HMP-20-11, HMP-20-21, HMP-2-10-11, HMP-2-20-11, HMP-6-11, MFHMM-20-11 |                 |                     |



2

|                    |   |                 |                     |
|--------------------|---|-----------------|---------------------|
| <b>GEV No.</b>     | 691052  | <b>Ref. No.</b> | 12017052<br>R723012 |
| <b>description</b> | lifting magnet 230V voltage AC 50/60Hz duty cycle 100% 0.2A           |                 |                     |
| <b>For models:</b> | HMG-10-11, HMG-10-11UL, HMG-10-21, HMG-10-21UL, HMG-2-10-11, HMG-6-11 |                 |                     |



1

|                    |   |                 |                     |
|--------------------|---|-----------------|---------------------|
| <b>GEV No.</b>     | 691057  | <b>Ref. No.</b> | 12016965<br>R723060 |
| <b>description</b> | lifting magnet 230V voltage AC 50/60Hz duty cycle 100% 0.3A |                 |                     |
| <b>For models:</b> | HMG-20-11   |                 |                     |

PEL  
vsezip.ru  
225/O series

+7(812)987-08-81



1















|   |  |                 |                     |  |
|---|--|-----------------|---------------------|--|
| <b>GEV No.</b>  | 109513   | <b>Ref. No.</b> | 12017435<br>T032101 |  |
| <b>description</b>  | gas tap PEL type 225/O gas inlet M20x1.5 (tube ø 12mm) bypass nozzle ø 1.1mm gas outlet M20x1.5 (tube ø 12/10mm) thermocouple connection M8x1 pilot connection M10x1 shaft ø 10x8mm shaft L 25/17mm shaft flat right |                 |                     |  |
| <b>For models:</b>  | BG7-05, BG7-10   |                 |                     |  |
| <b>spare parts for</b>  | 109513   |                 |                     |  |
|    | <b>GEV No.</b>   | 100436          | <b>Ref. No.</b>     | —  |
|   | bypass nozzle type PEL22 bore ø 1.1mm thread M6x0.5  |                 |                     |  |
|    | <b>GEV No.</b>   | 101058          | <b>Ref. No.</b>     | —  |
|   | magnet unit L 39mm D1 ø 15.4mm D2 ø 13.5mm suitable for PEL22/EGA24197 standard  |                 |                     |  |
|    | <b>GEV No.</b>   | 101202          | <b>Ref. No.</b>     | —  |
|   | gas tap front part shaft ø 8x10mm shaft L 25/17mm shaft flat right/left suitable for PEL22   |                 |                     |  |
|   | <b>GEV No.</b>   | 101230          | <b>Ref. No.</b>     | —  |
|   | thermocouple nut T1: M8x1 T2: M18x1 aluminium  |                 |                     |  |
|  | <b>GEV No.</b>   | 101240          | <b>Ref. No.</b>     | —  |
|   | gas connection thread M20x1.5 tube ø 12/10mm for PEL gas taps with gasket and screws horizontal  |                 |                     |  |
|  | <b>GEV No.</b>   | 101460          | <b>Ref. No.</b>     | —  |
|   | O-ring ø 12.37mm D1 ø 2.62mm suitable for PEL22  |                 |                     |  |
|  | <b>GEV No.</b>   | 101461          | <b>Ref. No.</b>     | —  |
|   | screw kit suitable for PEL22 Qty 4 pcs   |                 |                     |  |
| <b>accessories for</b>  | 109513   |                 |                     |  |
|  | <b>GEV No.</b>   | 100908          | <b>Ref. No.</b>     | 12017481<br>T052101                        |
|   | union screw thread M10x1 for pipe ø 4mm Qty 1 pcs  |                 |                     |  |
|  | <b>GEV No.</b>   | 100909          | <b>Ref. No.</b>     | 12008740<br>12016658<br>S312107<br>U265703 |
|   | union screw thread M10x1 for pipe ø 6mm Qty 1 pcs  |                 |                     |  |
|  | <b>GEV No.</b>   | 101241          | <b>Ref. No.</b>     | —  |
|   | gas connection thread M20x1.5 tube ø 12/10mm for PEL gas taps vertical   |                 |                     |  |
|  | <b>GEV No.</b>   | 101246          | <b>Ref. No.</b>     | 12018994<br>U265026                        |
|   | olive for pipe ø 4mm Qty 1 pcs   |                 |                     |  |
|  | <b>GEV No.</b>   | 101248          | <b>Ref. No.</b>     | —  |
|   | olive for pipe ø 12mm Qty 1 pcs suitable for PEL   |                 |                     |  |
|  | <b>GEV No.</b>   | 101249          | <b>Ref. No.</b>     | —  |
|   | olive for pipe ø 10mm Qty 1 pcs  |                 |                     |  |
|  | <b>GEV No.</b>   | 101250          | <b>Ref. No.</b>     | —  |
|   | union nut thread M20x1.5 for pipe ø 10mm   |                 |                     |  |



Table continues overleaf





Зип-Общепит

vsezip.ru

+7(812)987-08-81

|   |         |        |          |                                   |
|---|---------|--------|----------|-----------------------------------|
| <b>accessories for</b> 109513   |         |        |          |                                   |
|  | GEV No. | 101251 | Ref. No. | —                                 |
| union nut thread M20x1.5 for pipe ø 12mm  |         |        |          |                                   |
|  | GEV No. | 101286 | Ref. No. | 12008476<br>S312108000<br>X205028 |
| olive ID ø 6mm Qty 1 pcs  |         |        |          |                                   |

|   |         |        |          |                                   |
|---|---------|--------|----------|-----------------------------------|
| <b>accessories for</b> 109510   |         |        |          |                                   |
|  | GEV No. | 101250 | Ref. No. | —                                 |
| union nut thread M20x1.5 for pipe ø 10mm  |         |        |          |                                   |
|  | GEV No. | 101251 | Ref. No. | —                                 |
| union nut thread M20x1.5 for pipe ø 12mm  |         |        |          |                                   |
|  | GEV No. | 101286 | Ref. No. | 12008476<br>S312108000<br>X205028 |
| olive ID ø 6mm Qty 1 pcs  |         |        |          |                                   |



|   |                |        |                 |  |
|---|----------------|--------|-----------------|--|
| <b>1</b>  | <b>GEV No.</b> | 109510 | <b>Ref. No.</b> | 12017451<br>T052100                        |
| <b>description</b> gas tap PEL type 22S/O gas inlet M20x1.5 (tube ø 12mm) bypass nozzle ø 1.3mm gas outlet M20x1.5 (tube ø 12/10mm) thermocouple connection M8x1 pilot connection M10x1 shaft ø 10x8mm shaft L 25/17mm shaft flat right |                |        |                 |  |
| <b>For models:</b> BG9-05, BG9-05I, BG9-10, BG9-10I   |                |        |                 |  |
| <b>spare parts for</b> 109510   |                |        |                 |  |
|    | GEV No.        | 100438 | Ref. No.        | —  |
| bypass nozzle type PEL22 bore ø 1.2mm thread M6x0.5   |                |        |                 |  |
|    | GEV No.        | 101058 | Ref. No.        | —  |
| magnet unit L 39mm D1 ø 15.4mm D2 ø 13.5mm suitable for PEL22/EGA24197 standard   |                |        |                 |  |
|   | GEV No.        | 101202 | Ref. No.        | —  |
| gas tap front part shaft ø 8x10mm shaft L 25/17mm shaft flat right/left suitable for PEL22  |                |        |                 |  |
|    | GEV No.        | 101230 | Ref. No.        | —  |
| thermocouple nut T1: M8x1 T2: M18x1 aluminium   |                |        |                 |  |
|    | GEV No.        | 101240 | Ref. No.        | —  |
| gas connection thread M20x1.5 tube ø 12/10mm for PEL gas taps with gasket and screws horizontal   |                |        |                 |  |
|    | GEV No.        | 101460 | Ref. No.        | —  |
| O-ring ø 12.37mm D1 ø 2.62mm suitable for PEL22   |                |        |                 |  |
|    | GEV No.        | 101461 | Ref. No.        | —  |
| screw kit suitable for PEL22 Qty 4 pcs  |                |        |                 |  |
| <b>accessories for</b> 109510   |                |        |                 |  |
|    | GEV No.        | 100908 | Ref. No.        | 12017481<br>T052101                        |
| union screw thread M10x1 for pipe ø 4mm Qty 1 pcs   |                |        |                 |  |
|    | GEV No.        | 100909 | Ref. No.        | 12008740<br>12016658<br>S312107<br>U265703 |
| union screw thread M10x1 for pipe ø 6mm Qty 1 pcs   |                |        |                 |  |
|    | GEV No.        | 101241 | Ref. No.        | —  |
| gas connection thread M20x1.5 tube ø 12/10mm for PEL gas taps vertical  |                |        |                 |  |
|    | GEV No.        | 101246 | Ref. No.        | 12018994<br>U265026                        |
| olive for pipe ø 4mm Qty 1 pcs  |                |        |                 |  |
|    | GEV No.        | 101248 | Ref. No.        | —  |
| olive for pipe ø 12mm Qty 1 pcs suitable for PEL  |                |        |                 |  |
|    | GEV No.        | 101249 | Ref. No.        | —  |
| olive for pipe ø 10mm Qty 1 pcs   |                |        |                 |  |

22S/V series













|   |                |        |                 |  |
|---|----------------|--------|-----------------|--|
| <b>1</b>  | <b>GEV No.</b> | 106421 | <b>Ref. No.</b> | 12026757<br>K002B42010                     |
| <b>description</b> gas tap PEL type 22S/V gas inlet M20x1.5 (tube ø 12mm) bypass nozzle ø 0mm gas outlet M20x1.5 (tube ø 12/10mm) thermocouple connection M9x1 pilot connection M10x1 shaft ø 10x8mm shaft L 25/17mm shaft flat lower |                |        |                 |  |
| <b>spare parts for</b> 106421   |                |        |                 |  |
|   | GEV No.        | 101058 | Ref. No.        | —  |
| magnet unit L 39mm D1 ø 15.4mm D2 ø 13.5mm suitable for PEL22/EGA24197 standard   |                |        |                 |  |
|    | GEV No.        | 101201 | Ref. No.        | —  |
| gas tap front part shaft ø 10x8mm shaft L 25/17mm shaft flat upper/lower suitable for PEL22   |                |        |                 |  |
|    | GEV No.        | 101231 | Ref. No.        | —  |
| thermocouple nut T1: M9x1 T2: M18x1   |                |        |                 |  |
|    | GEV No.        | 101241 | Ref. No.        | —  |
| gas connection thread M20x1.5 tube ø 12/10mm for PEL gas taps vertical  |                |        |                 |  |
|    | GEV No.        | 101460 | Ref. No.        | —  |
| O-ring ø 12.37mm D1 ø 2.62mm suitable for PEL22   |                |        |                 |  |
|    | GEV No.        | 101461 | Ref. No.        | —  |
| screw kit suitable for PEL22 Qty 4 pcs  |                |        |                 |  |
|    | GEV No.        | 106191 | Ref. No.        | —  |
| bypass nozzle type PEL22 bore ø 0mm thread M6x0.5   |                |        |                 |  |
| <b>accessories for</b> 106421   |                |        |                 |  |
|    | GEV No.        | 100908 | Ref. No.        | 12017481<br>T052101                        |
| union screw thread M10x1 for pipe ø 4mm Qty 1 pcs   |                |        |                 |  |
|    | GEV No.        | 100909 | Ref. No.        | 12008740<br>12016658<br>S312107<br>U265703 |
| union screw thread M10x1 for pipe ø 6mm Qty 1 pcs   |                |        |                 |  |
|    | GEV No.        | 101240 | Ref. No.        | —  |
| gas connection thread M20x1.5 tube ø 12/10mm for PEL gas taps with gasket and screws horizontal   |                |        |                 |  |



Table continues overleaf











1 gas components

Зип-Общепит

vsezip.ru

+7(812)987-08-81

| accessories for   |         | 106421 |  |
|---|---------|--------|--|
|  | GEV No. | 101246 | Ref. No. 12018994<br>U265026               |
| olive for pipe ø 4mm Qty 1 pcs  |         |        |  |
|  | GEV No. | 101248 | Ref. No. —                                 |
| olive for pipe ø 12mm Qty 1 pcs suitable for PEL                                  |         |        |  |
|  | GEV No. | 101249 | Ref. No. —                                 |
| olive for pipe ø 10mm Qty 1 pcs   |         |        |  |
|  | GEV No. | 101250 | Ref. No. —                                 |
| union nut thread M20x1.5 for pipe ø 10mm  |         |        |  |
|  | GEV No. | 101251 | Ref. No. —                                 |
| union nut thread M20x1.5 for pipe ø 12mm  |         |        |  |
|  | GEV No. | 101286 | Ref. No. 12008476<br>S312108000<br>X205028 |
| olive ID ø 6mm Qty 1 pcs  |         |        |  |
|  | GEV No. | 101331 | Ref. No. —                                 |
| adapter suitable for PEL22 for flanged cable 10/12mm                              |         |        |  |

| accessories for   |         | 101091 |   |
|---|---------|--------|---|
|    | GEV No. | 100909 | Ref. No. 12008740<br>12016658<br>S312107<br>U265073 |
| union screw thread M10x1 for pipe ø 6mm Qty 1 pcs                                   |         |        |   |
|    | GEV No. | 101245 | Ref. No. 12018994<br>U265026                        |
| olive for pipe ø 4mm Qty 1 pcs  |         |        |   |
|    | GEV No. | 101252 | Ref. No. —  |
| union nut thread M24x1.5 for pipe ø 12mm  |         |        |   |
|    | GEV No. | 101253 | Ref. No. 12008865<br>S312105                        |
| union nut thread M24x1.5 PEL for pipe ø 16mm  |         |        |   |
|    | GEV No. | 101254 | Ref. No. 12008921<br>S312103                        |
| union nut thread M28x1.5 tube ø 20mm  |         |        |   |
|    | GEV No. | 101255 | Ref. No. —  |
| olive for pipe ø 12mm Qty 1 pcs   |         |        |   |
|    | GEV No. | 101256 | Ref. No. 12008773                                   |
| olive for pipe ø 16mm Qty 1 pcs   |         |        |   |
|    | GEV No. | 101257 | Ref. No. 12008828<br>S312104                        |
| olive for pipe ø 20mm Qty 1 pcs   |         |        |   |
|    | GEV No. | 101286 | Ref. No. 12008476<br>S312108000<br>X205028          |
| olive ID ø 6mm Qty 1 pcs  |         |        |   |
|   | GEV No. | 110080 | Ref. No. 12032882<br>ICR15738                       |
| knob ø 70mm shaft ø 10x8mm shaft flat universal                                     |         |        |   |
|  | GEV No. | 112206 | Ref. No. —  |
| knob dial plate silver gas tap PEL21/22/23 t.max.°C ED ø 63mm ID ø 45.5mm           |         |        |   |

23S/O series



|  |         |        |          |                      |
|--|---------|--------|----------|----------------------|
| 1  | GEV No. | 101091 | Ref. No. | 12027178<br>ICR10038 |
| <b>description</b>   |         |        |          |                      |
| gas tap PEL type 23S/O gas inlet M28x1.5 (tube ø 20mm) bypass nozzle ø 0.35mm gas outlet M24x1.5 (tube ø 16mm) thermocouple connection M9x1 pilot connection M10x1 shaft ø 10x8mm shaft L 35/19mm shaft flat upper |         |        |          |                      |
| <b>spare parts for</b>   |         | 101091 |          |                      |
|   | GEV No. | 100455 | Ref. No. | —                    |
| bypass nozzle type PEL23/24 bore ø 0.35mm thread M8x0.5  |         |        |          |                      |
|   | GEV No. | 101045 | Ref. No. | —                    |
| magnet unit T1: M9x1 T2: M22x1 L 46mm ø 18mm suitable for PEL23S M9x1  |         |        |          |                      |
|   | GEV No. | 101244 | Ref. No. | —                    |
| gas connection thread M24x1.5 tube ø 12/16mm horizontal for PEL gas taps   |         |        |          |                      |
|   | GEV No. | 101336 | Ref. No. | —                    |
| gas tap front part shaft ø 10x8mm shaft L 35/17mm shaft flat upper/lower suitable for PEL23S   |         |        |          |                      |
|   | GEV No. | 101463 | Ref. No. | —                    |
| screw suitable for PEL23S Qty 4 pcs  |         |        |          |                      |
|   | GEV No. | 528455 | Ref. No. | —                    |
| O-ring Viton thickness 2.62mm ID ø 18.72mm Qty 1 pcs   |         |        |          |                      |
| <b>accessories for</b>   |         | 101091 |          |                      |
|   | GEV No. | 100908 | Ref. No. | 12017481<br>T052101  |
| union screw thread M10x1 for pipe ø 4mm Qty 1 pcs  |         |        |          |                      |

23S/V series



|  |         |   |          |                     |
|--|---------|---|----------|---------------------|
| 1  | GEV No. | 109511  | Ref. No. | 12009525<br>S312101 |
| <b>description</b>   |         |   |          |                     |
| gas tap PEL type 23S/V gas inlet M28x1.5 (tube ø 20mm) bypass nozzle ø 1.4mm gas outlet M24x1.5 (tube ø 16/12mm) thermocouple connection M9x1 pilot connection M10x1 shaft ø 10x8mm shaft L 25/17mm shaft flat lower |         |   |          |                     |
| <b>For models:</b>   |         | MG7-10, MG7-10BM, MG9-10, MG9-10BM, MG9-10BMS, MG9-10S, MG9-15, MG9-15BM, MG9-15BM316, MG9-15BMS, MG9-15S, MG9-20, MG9-20S, MPG9-10, MPG9-10BM, MPG9-10BMS, MPG9-10S, MPG9-15, MPG9-15BM, MPG9-15BMS, MPG9-15S, MPG9-20, MPG9-20S |          |                     |
| <b>spare parts for</b>   |         | 109511  |          |                     |
|   | GEV No. | 100455  | Ref. No. | —                   |
| bypass nozzle type PEL23/24 bore ø 0.35mm thread M8x0.5  |         |   |          |                     |

Table continues overleaf



Зип Общепит

vsezip.ru

+7(812)987-08-81

| spare parts for  |         | 109511 |  |
|--|---------|--------|--|
|  | GEV No. | 101059 | Ref. No. —                                 |
| magnet unit T1: M10x1 T2: M22x1 L 46mm ø 18mm suitable for PEL23S M10x1                      |         |        |  |
|  | GEV No. | 101204 | Ref. No. —                                 |
| gas tap front part shaft ø 10x8mm shaft L 25/17mm shaft flat upper/lower suitable for PEL23S |         |        |  |
|  | GEV No. | 101245 | Ref. No. —                                 |
| gas connection thread M24x1.5 tube ø 12/16mm vertical for PEL gas taps                       |         |        |  |
|  | GEV No. | 101463 | Ref. No. —                                 |
| screw suitable for PEL23S Qty 4 pcs  |         |        |  |
|  | GEV No. | 528455 | Ref. No. —                                 |
| O-ring Viton thickness 2.62mm ID ø 18.72mm Qty 1 pcs   |         |        |  |
| accessories for  |         | 109511 |  |
|  | GEV No. | 100908 | Ref. No. 12017481 T052101                  |
| union screw thread M10x1 for pipe ø 4mm Qty 1 pcs  |         |        |  |
|  | GEV No. | 100909 | Ref. No. 12008740 12016658 S312107 U265703 |
| union screw thread M10x1 for pipe ø 6mm Qty 1 pcs  |         |        |  |
|  | GEV No. | 101246 | Ref. No. 12018994 U265026                  |
| olive for pipe ø 4mm Qty 1 pcs   |         |        |  |
|  | GEV No. | 101252 | Ref. No. —                                 |
| union nut thread M24x1.5 for pipe ø 12mm   |         |        |  |
|  | GEV No. | 101253 | Ref. No. 12008865 S312105                  |
| union nut thread M24x1.5 PEL for pipe ø 16mm   |         |        |  |
|  | GEV No. | 101254 | Ref. No. 12008921 S312103                  |
| union nut thread M28x1.5 tube ø 20mm   |         |        |  |
|  | GEV No. | 101255 | Ref. No. —                                 |
| olive for pipe ø 12mm Qty 1 pcs  |         |        |  |
|  | GEV No. | 101256 | Ref. No. 12008773                          |
| olive for pipe ø 16mm Qty 1 pcs  |         |        |  |
|  | GEV No. | 101257 | Ref. No. 12008828 S312104                  |
| olive for pipe ø 20mm Qty 1 pcs  |         |        |  |
|  | GEV No. | 101286 | Ref. No. 12008476 S312108000 X205028       |
| olive ID ø 6mm Qty 1 pcs   |         |        |  |
|  | GEV No. | 110080 | Ref. No. 12032882 ICR15738                 |
| knob ø 70mm shaft ø 10x8mm shaft flat universal  |         |        |  |
|  | GEV No. | 112206 | Ref. No. —                                 |
| knob dial plate silver gas tap PEL21/22/23 t.max.°C ED ø 63mm ID ø 45.5mm                    |         |        |  |

| CAL-3200   |  | COPRECI  |                           |
|--|--|----------|---------------------------|
|  | 1  |          |                           |
| GEV No.  | 109503   | Ref. No. | 12009463 U249401 U262112  |
| description  | gas tap COPRECI type CAL-3200 gas inlet M18x1.5 (tube ø 12mm) bypass nozzle ø 0.55mm gas outlet M18x1.5 (tube ø 12mm) thermo-couple connection M8x1 pilot connection 1/8" shaft ø 10x8mm shaft flat right shaft L 29/12mm with pipe outlet                             |          |                           |
| For models:  | CG-1002, CG-1502, CG-2000, CG-2002, CG-2002P, CG-2005, CG-210, CG-210G, CG-300S, CG-310, CG-310G, CG9-20, CG9-40, CG9-41, CG9-51L, CG9-51LC, CG9-51R, CG9-51RC, CG9-60, CG9-61, CG9-82, CG9-82, CG9-82, CG9-82, PL-105C, PL-105L, PL-110C, PL-110L, PL-110L+R, PL-110R |          |                           |
| spare parts for  | 109503   |          |                           |
|  | GEV No.  | 106173   | Ref. No. —                |
| magnet unit L 43mm D1 ø 19mm D2 ø 15.5mm suitable for COPRECI        |  |          |                           |
| accessories for  | 109503   |          |                           |
|  | GEV No.  | 100944   | Ref. No. 12007951 Q221336 |
| union nut thread M18x1.5 for pipe ø 12mm                             |  |          |                           |
|  | GEV No.  | 101273   | Ref. No. 12008501 U055043 |
| olive for pipe ø 12mm L 9.5mm brass Qty 1 pcs suitable for universal |  |          |                           |

|  |  |          |  |
|--|--|----------|--|
|  | 1  |          |  |
| GEV No.  | 109500   | Ref. No. | 12017387 12040023 R642100 R642100000 U262106 |
| description  | gas tap COPRECI type CAL-3200 gas inlet M18x1.5 (tube ø 12mm) bypass nozzle ø 0.55mm gas outlet M18x1.5 (tube ø 12mm) thermo-couple connection M8x1 pilot connection 1/8" shaft ø 10x8mm shaft flat right shaft L 46/12mm with pipe outlet |          |  |
| For models:  | CG7-20, CG-7200, CG7-40, CG-7400, CG7-41, CG-7415, CG7-61, CG-7615, CGB7-61, CGE7-140, CGE7-41, FTG-7050L, FTG-7050R, FTG-7100L, FTG-7100L+R, FTG-7100R  |          |  |
| spare parts for  | 109500   |          |  |
|  | GEV No.  | 106173   | Ref. No. —                                   |
| magnet unit L 43mm D1 ø 19mm D2 ø 15.5mm suitable for COPRECI        |  |          |  |
| accessories for  | 109500   |          |  |
|  | GEV No.  | 100944   | Ref. No. 12007951 Q221336                    |
| union nut thread M18x1.5 for pipe ø 12mm                             |  |          |  |
|  | GEV No.  | 101273   | Ref. No. 12008501 U055043                    |
| olive for pipe ø 12mm L 9.5mm brass Qty 1 pcs suitable for universal |  |          |  |

1 gas components



Зип Общепит

vsezip.ru

+7(812)987-08-81



1

|  |   |                 |                                     |
|--|---|-----------------|-------------------------------------|
| <b>GEV No.</b>   | 109509  | <b>Ref. No.</b> | 12017385<br>R612100                 |
| <b>description</b>   | gas tap COPRECI type CAL-3200 gas inlet M18x1.5 (tube ø 12mm) bypass nozzle ø 0.8mm gas outlet M18x1.5 (tube ø 12mm) thermo-couple connection M8x1 pilot connection 1/8" shaft ø 10x8mm shaft flat right shaft L 29/12mm with pipe outlet   |                 |                                     |
| <b>For models:</b>   | CG-110, CG-2000-2P, CPG7-05, FTG-9050L, FTG-9050R, FTG9-05L, FTG9-05R, FTG9-05VL, FTG9-05VR, FTG-9100L, FTG-9100L+R, FTG-9100R, FTG9-10L, FTG9-10L+R, FTG9-10R, FTG9-10VL, FTG9-10VL+R, FTG9-10VR, FTG9-11L, FTG9-11L+R, FTG9-11R, FTGC9-05L, FTGC9-05R, FTGC9-10L, FTGC9-10L+R, FTGC9-10R, FTGC9-11L, FTGC9-11L+R, FTGC9-11R |                 |                                     |
| <b>spare parts for</b>   | 109509  |                 |                                     |
|   | <b>GEV No.</b>  | 106173          | <b>Ref. No.</b> —                   |
| magnet unit L 43mm D1 ø 19mm D2 ø 15.5mm suitable for COPRECI                      |   |                 |                                     |
| <b>accessories for</b>   | 109509  |                 |                                     |
|   | <b>GEV No.</b>  | 100944          | <b>Ref. No.</b> 12007951<br>Q221336 |
| union nut thread M18x1.5 for pipe ø 12mm   |   |                 |                                     |
|  | <b>GEV No.</b>  | 101273          | <b>Ref. No.</b> 12008501<br>U055043 |
| olive for pipe ø 12mm L 9.5mm brass Qty 1 pcs suitable for universal               |   |                 |                                     |







1

|  |   |                 |                                     |
|--|---|-----------------|-------------------------------------|
| <b>GEV No.</b>   | 109501  | <b>Ref. No.</b> | 12017386<br>U262107                 |
| <b>description</b>   | gas tap COPRECI type CAL-3200 gas inlet M18x1.5 (tube ø 12mm) bypass nozzle ø 0.9mm gas outlet M18x1.5 (tube ø 12mm) thermo-couple connection M8x1 pilot connection 1/8" shaft ø 10x8mm shaft flat right shaft L 46/12mm with pipe outlet |                 |                                     |
| <b>For models:</b>   | CG-7115, CG-7200, CG7-40, CG-7400, CG7-41, CG-7415, CG7-61, CG-7615, CGB7-61, CGE7-137, CGE7-41   |                 |                                     |
| <b>spare parts for</b>   | 109501  |                 |                                     |
|   | <b>GEV No.</b>  | 106173          | <b>Ref. No.</b> —                   |
| magnet unit L 43mm D1 ø 19mm D2 ø 15.5mm suitable for COPRECI                      |   |                 |                                     |
|   | <b>GEV No.</b>  | 109413          | <b>Ref. No.</b> 12016664<br>U022111 |
| bypass nozzle type COPRECI CAL-3200 bore ø 0.9mm thread M8x0.75 WS 11              |   |                 |                                     |
| <b>accessories for</b>   | 109501  |                 |                                     |
|   | <b>GEV No.</b>  | 100944          | <b>Ref. No.</b> 12007951<br>Q221336 |
| union nut thread M18x1.5 for pipe ø 12mm   |   |                 |                                     |
|  | <b>GEV No.</b>  | 101273          | <b>Ref. No.</b> 12008501<br>U055043 |
| olive for pipe ø 12mm L 9.5mm brass Qty 1 pcs suitable for universal               |   |                 |                                     |



1

|   |  |                 |                                     |
|---|--|-----------------|-------------------------------------|
| <b>GEV No.</b>  | 109504   | <b>Ref. No.</b> | 12009464<br>U249402<br>U262113      |
| <b>description</b>  | gas tap COPRECI type CAL-3200 gas inlet M18x1.5 (tube ø 12mm) bypass nozzle ø 0.9mm gas outlet M18x1.5 (tube ø 12mm) thermo-couple connection M8x1 pilot connection 1/8" shaft ø 10x8mm shaft flat right shaft L 30/12mm with pipe outlet  |                 |                                     |
| <b>For models:</b>  | CG-1002, CG-1502, CG-2000, CG-2000-2P, CG-2002, CG-2002P, CG-2005, CG-210, CG-210G, CG-300S, CG-310, CG-310G, CG9-20, CG9-40, CG9-41, CG9-51L, CG9-51LC, CG9-51R, CG9-51RC, CG9-60, CG9-61, CG9-82, CGE9-41, CPG9-05, CPG9-05NC, CPG9-05S, CPG9-05SNC, FTG7-05VL, FTG7-05VR, FTG7-10VL, FTG7-10VL+R, FTG7-10VR |                 |                                     |
| <b>spare parts for</b>  | 109504   |                 |                                     |
|  | <b>GEV No.</b>   | 106173          | <b>Ref. No.</b> —                   |
| magnet unit L 43mm D1 ø 19mm D2 ø 15.5mm suitable for COPRECI                       |  |                 |                                     |
|  | <b>GEV No.</b>   | 109413          | <b>Ref. No.</b> 12016664<br>U022111 |
| bypass nozzle type COPRECI CAL-3200 bore ø 0.9mm thread M8x0.75 WS 11               |  |                 |                                     |
| <b>accessories for</b>  | 109504   |                 |                                     |
|  | <b>GEV No.</b>   | 100944          | <b>Ref. No.</b> 12007951<br>Q221336 |
| union nut thread M18x1.5 for pipe ø 12mm  |  |                 |                                     |
|  | <b>GEV No.</b>   | 101273          | <b>Ref. No.</b> 12008501<br>U055043 |
| olive for pipe ø 12mm L 9.5mm brass Qty 1 pcs suitable for universal                |  |                 |                                     |



1





|   |  |                 |                                     |
|---|--|-----------------|-------------------------------------|
| <b>GEV No.</b>  | 109506   | <b>Ref. No.</b> | 12018189<br>U262111                 |
| <b>description</b>  | gas tap COPRECI type CAL-3200 gas inlet M18x1.5 (tube ø 12mm) bypass nozzle ø 0.9mm gas outlet M18x1.5 (tube ø 12mm) thermo-couple connection pilot connection 1/8" shaft ø 10x8mm shaft flat right shaft L 29/12mm with pipe outlet |                 |                                     |
| <b>For models:</b>  | CG-2000, CG-2000-2P, CG9-41, CG9-61, CG9-82  |                 |                                     |
| <b>spare parts for</b>  | 109506   |                 |                                     |
|  | <b>GEV No.</b>   | 106173          | <b>Ref. No.</b> —                   |
| magnet unit L 43mm D1 ø 19mm D2 ø 15.5mm suitable for COPRECI                       |  |                 |                                     |
|  | <b>GEV No.</b>   | 109413          | <b>Ref. No.</b> 12016664<br>U022111 |
| bypass nozzle type COPRECI CAL-3200 bore ø 0.9mm thread M8x0.75 WS 11               |  |                 |                                     |
| <b>accessories for</b>  | 109506   |                 |                                     |
|  | <b>GEV No.</b>   | 100944          | <b>Ref. No.</b> 12007951<br>Q221336 |
| union nut thread M18x1.5 for pipe ø 12mm  |  |                 |                                     |
|  | <b>GEV No.</b>   | 101273          | <b>Ref. No.</b> 12008501<br>U055043 |
| olive for pipe ø 12mm L 9.5mm brass Qty 1 pcs suitable for universal                |  |                 |                                     |











Зип Общепит





vsezip.ru

+7(812)987-08-81

|  |   |                 |                                     |
|--|---|-----------------|-------------------------------------|
|  <p>1</p> |   |                 |                                     |
| <b>GEV No.</b>   | 109049  | <b>Ref. No.</b> | 12018190<br>U262101                 |
| <b>description</b>   | gas tap COPRECI type CAL-3200 gas inlet M18x1.5 (tube ø 12mm) bypass nozzle ø 0.9mm gas outlet M18x1.5 (tube ø 12mm) thermo-couple connection pilot connection 1/8" shaft ø 10x8mm shaft flat right shaft L 46/12mm |                 |                                     |
| <b>For models:</b>   | CG-7200, CG-7400, CG-7415, CG-7615  |                 |                                     |
| <b>spare parts for</b>   | 109049  |                 |                                     |
|           | <b>GEV No.</b>  | 106173          | <b>Ref. No.</b> —                   |
|  | magnet unit L 43mm D1 ø 19mm D2 ø 15.5mm suitable for COPRECI   |                 |                                     |
|           | <b>GEV No.</b>  | 109413          | <b>Ref. No.</b> 12016664<br>U022111 |
|  | bypass nozzle type COPRECI CAL-3200 bore ø 0.9mm thread M8x0.75 WS 11   |                 |                                     |
| <b>accessories for</b>   | 109049  |                 |                                     |
|           | <b>GEV No.</b>  | 100944          | <b>Ref. No.</b> 12007951<br>Q221336 |
|  | union nut thread M18x1.5 for pipe ø 12mm  |                 |                                     |
|           | <b>GEV No.</b>  | 101273          | <b>Ref. No.</b> 12008501<br>U055043 |
|  | olive for pipe ø 12mm L 9.5mm brass Qty 1 pcs suitable for universal  |                 |                                     |

|   |   |                 |                                     |
|---|---|-----------------|-------------------------------------|
|  <p>1</p> |   |                 |                                     |
| <b>GEV No.</b>  | 109508  | <b>Ref. No.</b> | 12012263<br>U222101                 |
| <b>description</b>  | gas tap COPRECI type CAL-3200 gas inlet M18x1.5 (tube ø 12mm) bypass nozzle ø 1.2mm gas outlet M18x1.5 (tube ø 12mm) thermo-couple connection M8x1 pilot connection 1/8" shaft ø 10x8mm shaft flat right shaft L 30/12mm with pipe outlet |                 |                                     |
| <b>For models:</b>  | CG9-10, CG9-11, CG-9110, HP-G-15  |                 |                                     |
| <b>spare parts for</b>  | 109508  |                 |                                     |
|            | <b>GEV No.</b>  | 106173          | <b>Ref. No.</b> —                   |
|   | magnet unit L 43mm D1 ø 19mm D2 ø 15.5mm suitable for COPRECI   |                 |                                     |
| <b>accessories for</b>  | 109508  |                 |                                     |
|            | <b>GEV No.</b>  | 100944          | <b>Ref. No.</b> 12007951<br>Q221336 |
|   | union nut thread M18x1.5 for pipe ø 12mm  |                 |                                     |
|            | <b>GEV No.</b>  | 101273          | <b>Ref. No.</b> 12008501<br>U055043 |
|   | olive for pipe ø 12mm L 9.5mm brass Qty 1 pcs suitable for universal  |                 |                                     |

|  |  |                 |                                     |
|--|--|-----------------|-------------------------------------|
|  <p>1</p> |  |                 |                                     |
| <b>GEV No.</b>   | 109060   | <b>Ref. No.</b> | 12018400<br>T032103                 |
| <b>description</b>   | gas tap COPRECI type CAL-3200 gas inlet M18x1.5 (tube ø 12mm) bypass nozzle ø 1.1mm gas outlet M18x1.5 (tube ø 12mm) thermo-couple connection M8x1 pilot connection 1/8" shaft ø 10x8mm shaft flat right shaft L 29/12mm |                 |                                     |
| <b>For models:</b>   | BG7-05, BG7-05I, BG7-10, BG7-10I   |                 |                                     |
| <b>spare parts for</b>   | 109060   |                 |                                     |
|           | <b>GEV No.</b>   | 106173          | <b>Ref. No.</b> —                   |
|  | magnet unit L 43mm D1 ø 19mm D2 ø 15.5mm suitable for COPRECI  |                 |                                     |
| <b>accessories for</b>   | 109060   |                 |                                     |
|           | <b>GEV No.</b>   | 100944          | <b>Ref. No.</b> 12007951<br>Q221336 |
|  | union nut thread M18x1.5 for pipe ø 12mm   |                 |                                     |
|           | <b>GEV No.</b>   | 101273          | <b>Ref. No.</b> 12008501<br>U055043 |
|  | olive for pipe ø 12mm L 9.5mm brass Qty 1 pcs suitable for universal   |                 |                                     |

|  |   |                 |                                     |
|--|---|-----------------|-------------------------------------|
|  <p>1</p> |   |                 |                                     |
| <b>GEV No.</b>   | 109502  | <b>Ref. No.</b> | 12011453<br>U772100                 |
| <b>description</b>   | gas tap COPRECI type CAL-3200 gas inlet M18x1.5 (tube ø 12mm) bypass nozzle ø 1.2mm gas outlet M18x1.5 (tube ø 12mm) thermo-couple connection M8x1 pilot connection 1/8" shaft ø 10x8mm shaft flat right shaft L 46/12mm with pipe outlet |                 |                                     |
| <b>For models:</b>   | CG7-10, CG7-11  |                 |                                     |
| <b>spare parts for</b>   | 109502  |                 |                                     |
|           | <b>GEV No.</b>  | 106173          | <b>Ref. No.</b> —                   |
|  | magnet unit L 43mm D1 ø 19mm D2 ø 15.5mm suitable for COPRECI   |                 |                                     |
| <b>accessories for</b>   | 109502  |                 |                                     |
|           | <b>GEV No.</b>  | 100944          | <b>Ref. No.</b> 12007951<br>Q221336 |
|  | union nut thread M18x1.5 for pipe ø 12mm  |                 |                                     |
|           | <b>GEV No.</b>  | 101273          | <b>Ref. No.</b> 12008501<br>U055043 |
|  | olive for pipe ø 12mm L 9.5mm brass Qty 1 pcs suitable for universal  |                 |                                     |

Зип-Общепит

vsezip.ru

+7(812)987-08-81



1

|   |  |                 |                                     |
|---|--|-----------------|-------------------------------------|
| <b>GEV No.</b>  | 109505   | <b>Ref. No.</b> | 12009462<br>U702101                 |
| <b>description</b>  | gas tap COPRECI type CAL-3200 gas inlet M18x1.5 (tube ø 12mm) bypass nozzle ø 1.3mm gas outlet M18x1.5 (tube ø 12mm) thermocouple connection M8x1 pilot connection 1/8" shaft ø 10x8mm shaft flat right shaft L 29/12mm with pipe outlet |                 |                                     |
| <b>For models:</b>  | BG9-05, BG9-05I, BG9-10, BG9-10I, CG-1002, CG-1502, CG-2002, CG-2002P, CG9-40, CG9-41, CG9-51L, CG9-51LC, CG9-51R, CG9-51RC, CG9-60, CG9-61, CG9-82, CGE9-41, HP-G-15, HPG-15  |                 |                                     |
| <b>spare parts for</b>  | 109505   |                 |                                     |
|  | <b>GEV No.</b>   | 106173          | <b>Ref. No.</b> —                   |
|   | magnet unit L 43mm D1 ø 19mm D2 ø 15.5mm suitable for COPRECI  |                 |                                     |
| <b>accessories for</b>  | 109505   |                 |                                     |
|  | <b>GEV No.</b>   | 100944          | <b>Ref. No.</b> 12007951<br>Q221336 |
|   | union nut thread M18x1.5 for pipe ø 12mm   |                 |                                     |
|  | <b>GEV No.</b>   | 101273          | <b>Ref. No.</b> 12008501<br>U055043 |
|   | olive for pipe ø 12mm L 9.5mm brass Qty 1 pcs suitable for universal   |                 |                                     |



1



|                    |   |                 |                     |
|--------------------|---|-----------------|---------------------|
| <b>GEV No.</b>     | 109185  | <b>Ref. No.</b> | 12009457<br>U912102 |
| <b>description</b> | gas tap COPRECI type CAL-3200 gas inlet pipe flange ø21mm bypass nozzle ø 1mm gas outlet 3/8" (tube ø 10mm) thermocouple connection M8x1 pilot connection 1/8" shaft ø 8x6.5mm shaft flat upper shaft L 29/12mm |                 |                     |
| <b>For models:</b> | CPG9-05, CPG9-05AD, CPG9-05AD-S, CPG9-05NC, CPG9-05PLUS, CPG9-05PLUS-S, CPG9-05S, CPG9-05SNC  |                 |                     |



1



|   |   |                 |                     |
|---|---|-----------------|---------------------|
| <b>GEV No.</b>  | 109000  | <b>Ref. No.</b> | 12017322<br>U022101 |
| <b>description</b>  | gas tap COPRECI type CAL-3200 gas inlet pipe flange ø27mm bypass nozzle ø 0.55mm gas outlet 3/8" (tube ø 10mm) thermocouple connection M8x1 pilot connection 1/8" shaft ø 10x8mm shaft flat right shaft L 30/12mm |                 |                     |
| <b>For models:</b>  | CG9-10, CG9-11, CG9-20, CG9-40, CG9-41, CG9-51L, CG9-51LC, CG9-51R, CG9-51RC, CG9-60, CG9-61, CG9-82, CGE9-41, CGF9-120D, CGF9-120I, CGF9-121D, CGF9-121I, CPG9-05, CPG9-05S                                      |                 |                     |
| <b>spare parts for</b>  | 109000  |                 |                     |
|  | <b>GEV No.</b>  | 106173          | <b>Ref. No.</b> —   |
|   | magnet unit L 43mm D1 ø 19mm D2 ø 15.5mm suitable for COPRECI   |                 |                     |

accessories for 109000

|   |  |        |                 |                     |
|---|--|--------|-----------------|---------------------|
|  | <b>GEV No.</b>   | 100944 | <b>Ref. No.</b> | 12007951<br>Q221336 |
|   | union nut thread M18x1.5 for pipe ø 12mm                             |        |                 |                     |
|  | <b>GEV No.</b>   | 101273 | <b>Ref. No.</b> | 12008501<br>U055043 |
|   | olive for pipe ø 12mm L 9.5mm brass Qty 1 pcs suitable for universal |        |                 |                     |
|  | <b>GEV No.</b>   | 109195 | <b>Ref. No.</b> | 12016681<br>U022113 |
|   | bypass nozzle type COPRECI bore ø 1.3mm thread M8x0.75 WS 11         |        |                 |                     |





1

|   |   |                 |                                     |
|---|---|-----------------|-------------------------------------|
| <b>GEV No.</b>  | 109095  | <b>Ref. No.</b> | 12011431<br>U022108                 |
| <b>description</b>  | gas tap COPRECI type CAL-3200 gas inlet pipe flange ø27mm bypass nozzle ø 1.3mm gas outlet M18x1.5 (tube ø 12mm) thermocouple connection M8x1 pilot connection 1/8" shaft ø 10x8mm shaft flat right shaft L 29/12mm |                 |                                     |
| <b>For models:</b>  | BG9-05, BG9-05I, BG9-10, BG9-10I  |                 |                                     |
| <b>spare parts for</b>  | 109095  |                 |                                     |
|   | <b>GEV No.</b>  | 106173          | <b>Ref. No.</b> —                   |
|   | magnet unit L 43mm D1 ø 19mm D2 ø 15.5mm suitable for COPRECI   |                 |                                     |
| <b>accessories for</b>  | 109095  |                 |                                     |
|  | <b>GEV No.</b>  | 100944          | <b>Ref. No.</b> 12007951<br>Q221336 |
|   | union nut thread M18x1.5 for pipe ø 12mm  |                 |                                     |
|  | <b>GEV No.</b>  | 101273          | <b>Ref. No.</b> 12008501<br>U055043 |
|   | olive for pipe ø 12mm L 9.5mm brass Qty 1 pcs suitable for universal  |                 |                                     |

**CAL-5200**



1

|   |  |                 |   |
|---|--|-----------------|---|
| <b>GEV No.</b>  | 107693   | <b>Ref. No.</b> | 12018254<br>U872107                             |
| <b>description</b>  | gas tap COPRECI type CAL-5200 gas inlet pipe flange ø21mm bypass nozzle ø 0.7mm gas outlet 3/8" thermocouple connection M8x1 pilot connection shaft ø 8x6.5mm shaft L 32/12mm shaft flat right |                 |   |
| <b>For models:</b>  | CGP9-10, CGP9-11   |                 |   |
| <b>accessories for</b>  | 107693   |                 |   |
|  | <b>GEV No.</b>   | 101537          | <b>Ref. No.</b> 12010025<br>12017549<br>Q307034 |
|   | gasket ID ø 8mm ED ø 11.5mm H 3mm Qty 1 pcs  |                 |   |
|  | <b>GEV No.</b>   | 101538          | <b>Ref. No.</b> 12025294<br>Z982018             |
|   | clamp  |                 |   |





Зип Общепит

vsezip.ru

+7(812)987-08-81

CPMM18700

1



|   |   |                 |  |
|---|---|-----------------|--|
| <b>GEV No.</b>  | 106665  | <b>Ref. No.</b> | 12009411<br>12038526<br>H122103<br>U912101 |
| <b>description</b>  | gas tap COPRECI type CPMM18700 gas inlet pipe flange ø21mm bypass nozzle ø 0.5 / 0.75 / 0.9 / 1.15 / 1.45mm gas outlet 3/8" (tube ø 10mm) thermocouple connection M8x1 pilot connection M10x1 shaft ø 8x6.5mm shaft flat upper shaft L 41/12mm front fixing M15x1 |                 |  |
| <b>For models:</b>  | CG7-20, CG7-30D, CG7-30I, CG7-31D, CG7-31I, CG7-40, CG7-41, CG7-50, CG7-51, CG7-60, CG7-61, CGB7-61, CGB7-61R, CGE7-41  |                 |  |
| <b>spare parts for</b>  | 106665  |                 |  |
|  | <b>GEV No.</b>  | 107563          | <b>Ref. No.</b> 12002030                   |
| flange for gas tap L 48mm   |   |                 |  |

1



|                    |  |                 |                                 |
|--------------------|--|-----------------|---------------------------------|
| <b>GEV No.</b>     | 106948   | <b>Ref. No.</b> | 12003728<br>12038505<br>U912117 |
| <b>description</b> | gas tap with ignition flame COPRECI type CPMM18700 gas inlet pipe flange ø21mm bypass nozzle ø 1.45mm gas outlet 3/8" (tube ø 10mm) thermocouple connection M8x1 pilot connection M10x1 shaft ø 8x6.5mm shaft flat left shaft L 41/12mm with pipe outlet front fixing M15x1  |                 |                                 |
| <b>For models:</b> | CG9-20AD-H, CG9-20H, CG9-20PLUS, CG9-20PLUS-H, CG9-40, CG9-40AD, CG9-40AD-H, CG9-40H, CG9-40PLUS, CG9-40PLUS-H, CG9-41, CG9-41AD, CG9-41AD-H, CG9-41H, CG9-41PLUS, CG9-41PLUS-H, CG9-51L, CG9-51LC, CG9-51R, CG9-51RC, CG9-60, CG9-60AD, CG9-60AD-H, CG9-60H, CG9-60PLUS, CG9-60PLUS-H, CG9-61, CG9-61AD, CG9-61AD-H, CG9-61H, CG9-61OP, CG9-61PLUS, CG9-61PLUS-H, CG9-82, CG9-82AD, CG9-82PLUS, CGE9-41, CGE9-41AD, CGE9-41PLUS |                 |                                 |

1



|                    |   |                 |                                 |
|--------------------|---|-----------------|---------------------------------|
| <b>GEV No.</b>     | 107314  | <b>Ref. No.</b> | 12003724<br>12038522<br>R902102 |
| <b>description</b> | gas tap with ignition flame COPRECI type CPMM18700 gas inlet pipe flange ø21mm bypass nozzle ø 0.9mm gas outlet 3/8" (tube ø 10mm) thermocouple connection M8x1 pilot connection M10x1 shaft ø 8x6.5mm shaft L 41/12mm shaft flat right front fixing M15x1                |                 |                                 |
| <b>For models:</b> | FTG7-05VL, FTG7-05VR, FTG7-10VL, FTG7-10VL+R, FTG7-10VR, FTG9-05LV-AD, FTG9-05PLUS-LV, FTG9-05PLUS-RV, FTG9-05RV-AD, FTG9-05VL, FTG9-05VR, FTG9-10L+RV-AD, FTG9-10LV-AD, FTG9-10PLUS-LRV, FTG9-10PLUS-LV, FTG9-10PLUS-RV, FTG9-10RV-AD, FTG9-10VL, FTG9-10VL+R, FTG9-10VR |                 |                                 |

1



|                    |  |                 |                                    |
|--------------------|--|-----------------|------------------------------------|
| <b>GEV No.</b>     | 106947   | <b>Ref. No.</b> | 11U9121150<br>12003727<br>12038506 |
| <b>description</b> | gas tap with ignition flame type CPMM18700 gas inlet pipe flange ø21mm bypass nozzle ø 0.75mm gas outlet 3/8" (tube ø 10mm) thermocouple connection M8x1 pilot connection M10x1 shaft ø 8x6.5mm shaft flat upper shaft L 41/12mm with pipe outlet front fixing M15x1   |                 |                                    |
| <b>For models:</b> | CG9-05AD, CG9-05PLUS, CG9-20, CG9-20AD, CG9-20H, CG9-20PLUS, CG9-31PLUS-D, CG9-31PLUS-L, CG9-40, CG9-40AD, CG9-40H, CG9-40PLUS, CG9-41, CG9-41AD, CG9-41H, CG9-41PLUS, CG9-51L, CG9-51LC, CG9-51R, CG9-51RC, CG9-60, CG9-60AD, CG9-60H, CG9-60PLUS, CG9-61, CG9-61AD, CG9-61H, CG9-61OP, CG9-61PLUS, CG9-82, CG9-82AD, CG9-82PLUS, CGE9-41, CGE9-41AD, CGE9-41PLUS, CGF9-120D, CGF9-120D-AD, CGF9-120I, CGF9-120I-AD, CGF9-120PLUS-D, CGF9-120PLUS-L, CGF9-121D, CGF9-121D-AD, CGF9-121I, CGF9-121I-AD, CGF9-121PLUS-D, CGF9-121PLUS-L |                 |                                    |

1



|   |  |                 |                                     |
|---|--|-----------------|-------------------------------------|
| <b>GEV No.</b>  | 106958   | <b>Ref. No.</b> | 11U9121090<br>12038507              |
| <b>description</b>  | gas tap with ignition flame COPRECI type CPMM18700 gas inlet pipe flange ø21mm bypass nozzle ø 1.15mm gas outlet 3/8" (tube ø 10mm) thermocouple connection M8x1 pilot connection M10x1 shaft ø 8x6.5mm shaft flat right shaft L 41/12mm with pipe outlet front fixing M15x1 |                 |                                     |
| <b>spare parts for</b>  | 106958   |                 |                                     |
|  | <b>GEV No.</b>   | 101060          | <b>Ref. No.</b> 608205<br>608205000 |
| magnet unit standard L 39mm D1 ø 15.4mm D2 ø 11mm suitable for PEL20-21/JUNKERS/EGA |  |                 |                                     |

1 gas components

gas thermostats

SIT

630 Eurosit series



|  |   |                 |                                     |
|--|---|-----------------|-------------------------------------|
| <b>GEV No.</b>   | 106164  | <b>Ref. No.</b> | 12023415<br>R152102                 |
| <b>description</b>   | gas thermostat type 630 Eurosit series t.max. 340°C 100-340°C gas inlet 3/8" gas outlet 3/8" thermocouple connection M9x1 pilot connection M10x1 probe ø 4mm probe L 72mm capillary pipe 1050mm pressure regulator 13-18mbar ambient temperature max. 0-120°C   |                 |                                     |
| <b>For models:</b>   | CG7-11, CG7-31D, CG7-31I, CG7-41, CG7-41H, CG7-51, CG7-61, CG7-61H, CG9-51L, CG9-51LC, CG9-51R, CG9-51RC, CGB7-61, CGB7-61H, CGB7-61R, CGB7-61RH, CGP9-11, FTG9-05L, FTG9-05L-AD, FTG9-05PLUS-CL, FTG9-05PLUS-CR, FTG9-05PLUS-L, FTG9-05PLUS-R, FTG9-05R, FTG9-05R-AD, FTG9-05VL, FTG9-05VR, FTG9-10L, FTG9-10L+R, FTG9-10L+R-AD, FTG9-10L-AD, FTG9-10PLUS-CL, FTG9-10PLUS-CLR, FTG9-10PLUS-CR, FTG9-10PLUS-L, FTG9-10PLUS-LR, FTG9-10PLUS-R, FTG9-10R, FTG9-10R-AD, FTG9-10VL, FTG9-10VL+R, FTG9-10VR, FTG9-11L, FTG9-11L+R, FTG9-11R, FTGC9-05L, FTGC9-05L-AD, FTGC9-05R, FTGC9-05R-AD, FTGC9-10L...(Other models you can see in the webshop) |                 |                                     |
| <b>accessories for</b>   | 106164  |                 |                                     |
|  | <b>GEV No.</b>  | 100904          | <b>Ref. No.</b> 12008755            |
| locking screw M10x1 for pipe ø 4mm Qty 1 pcs                         |   |                 |                                     |
|  | <b>GEV No.</b>  | 100905          | <b>Ref. No.</b> 12008715<br>U134323 |
| locking screw M10x1 for pipe ø 6mm Qty 1 pcs                         |   |                 |                                     |
|  | <b>GEV No.</b>  | 101273          | <b>Ref. No.</b> 12008501<br>U055043 |
| olive for pipe ø 12mm L 9.5mm brass Qty 1 pcs suitable for universal |   |                 |                                     |
|  | <b>GEV No.</b>  | 101276          | <b>Ref. No.</b> 12008081<br>U264310 |
| union screw thread 3/8" tube ø 12mm Qty 1 pcs                        |   |                 |                                     |
|  | <b>GEV No.</b>  | 101333          | <b>Ref. No.</b> 12008964            |
| plug thread 3/8" with O-ring   |   |                 |                                     |

Зип Обществ

vsezip.ru

+7(812)987-08-81



|  |   |                 |                                     |
|--|---|-----------------|-------------------------------------|
| <b>GEV No.</b>   | 101125  | <b>Ref. No.</b> | 12009504<br>T982100                 |
| <b>description</b>   | gas thermostat type 630 Eurosit series t.max. 340°C 100-340°C gas inlet 3/8" gas outlet 3/8" thermocouple connection M9x1 pilot connection M10x1 probe ø 4mm probe L 72mm capillary pipe 1050mm SIT   |                 |                                     |
| <b>For models:</b>   | CG-210, CG-210G, CG-310, CG-310G, CG7-11, CG7-31D, CG7-31I, CG7-41, CG7-41H, CG7-51, CG7-61, CG7-61H, CG9-51L, CG9-51LC, CG9-51R, CG9-51RC, CGB7-61, CGB7-61H, CGB7-61R, CGB7-61RH, CGP9-11, FTG7-05L, FTG7-05R, FTG7-10L, FTG7-10L+R, FTG7-10R, FTG9-05L, FTG9-05R, FTG9-10L, FTG9-10L+R, FTG9-10R, FTG9-11L, FTG9-11L+R, FTG9-11R, FTGC7-05L, FTGC7-10L, FTGC9-05L, FTGC9-05R, FTGC9-10L, FTGC9-10L+R, FTGC9-10R, FTGC9-11L, FTGC9-11L+R, FTGC9-11R, HG9-10, HG9-20 |                 |                                     |
| <b>accessories for</b>   | 101125  |                 |                                     |
|  | <b>GEV No.</b>  | 100825          | <b>Ref. No.</b> —                   |
| gas tap spindle shaft ø 8x6.5mm shaft L 22/14mm suitable for EUROISIT  |   |                 |                                     |
|  | <b>GEV No.</b>  | 100904          | <b>Ref. No.</b> 12008755            |
| locking screw M10x1 for pipe ø 4mm Qty 1 pcs   |   |                 |                                     |
|  | <b>GEV No.</b>  | 100905          | <b>Ref. No.</b> 12008715<br>U134323 |
| locking screw M10x1 for pipe ø 6mm Qty 1 pcs   |   |                 |                                     |
|  | <b>GEV No.</b>  | 100949          | <b>Ref. No.</b> —                   |
| gasket suitable for 630 Eurosit series   |   |                 |                                     |
|  | <b>GEV No.</b>  | 101273          | <b>Ref. No.</b> 12008501<br>U055043 |
| olive for pipe ø 12mm L 9.5mm brass Qty 1 pcs suitable for universal   |   |                 |                                     |
|  | <b>GEV No.</b>  | 101276          | <b>Ref. No.</b> 12008081<br>U264310 |
| union screw thread 3/8" tube ø 12mm Qty 1 pcs  |   |                 |                                     |
|  | <b>GEV No.</b>  | 101333          | <b>Ref. No.</b> 12008964            |
| plug thread 3/8" with O-ring   |   |                 |                                     |
|  | <b>GEV No.</b>  | 101390          | <b>Ref. No.</b> —                   |
| gas tap spindle shaft ø 6x4.6mm shaft L 32/15mm gas tap with ignition flame suitable for ZANUSSI, MARENO for gas thermostat EUROISIT |   |                 |                                     |
|  | <b>GEV No.</b>  | 101392          | <b>Ref. No.</b> —                   |
| adapter suitable for 630 Eurosit series  |   |                 |                                     |
|  | <b>GEV No.</b>  | 110357          | <b>Ref. No.</b> —                   |
| gas tap spindle shaft ø 8x6.5mm shaft L 36/12mm suitable for 630 Eurosit series  |   |                 |                                     |
|  | <b>GEV No.</b>  | 110358          | <b>Ref. No.</b> —                   |
| adapter shaft ø 10x8mm shaft L 29/18mm suitable for 630 Eurosit series   |   |                 |                                     |



710 Minisit series

Зип-Общепит

vsezip.ru

+7(812)987-08-81



|                        |  |                 |  |
|------------------------|--|-----------------|--|
| <b>GEV No.</b>         | 101435   | <b>Ref. No.</b> | 12009530<br>U134316<br>U134324         |
| <b>description</b>     | gas thermostat SIT type MINISIT 710 t.max. 340°C 100-340°C gas inlet 1/2" gas outlet 3/8" thermocouple connection M9x1 pilot connection M10x1 probe ø 4mm probe L 72mm capillary pipe 1050mm probe type type C1 pressure controller no pressure regulator gland nut  |                 |  |
| <b>For models:</b>     | CG-1002, CG-1502, CG-2000, CG-2000-2P, CG-2002, CG-2002P, CG9-11, CG-9110, CG9-11AD, CG9-11PLUS, CG9-31PLUS-D, CG9-31PLUS-I, CG9-41, CG9-41AD, CG9-41AD-H, CG9-41H, CG9-41PLUS, CG9-41PLUS-H, CG9-51L, CG9-51LC, CG9-51R, CG9-51RC, CG9-61, CG9-61AD, CG9-61AD-H, CG9-61H, CG9-61OP, CG9-61PLUS, CG9-61PLUS-H, CG9-82, CG9-82AD, CG9-82PLUS, CGF9-121D, CGF9-121D-AD, CGF9-121I, CGF9-121PLUS-D, CGF9-121PLUS-I, CG-HP-20, FI-5420, FI-7630, FTG9-11L, FTG9-11L+R, FTG9-11R, FTGC9-11L, FTGC9-11L+R, FTGC9-11R, HG9-10, HG9-15, HG9-20 |                 |  |
| <b>spare parts for</b> | 101435   |                 |  |
|                        | <b>GEV No.</b>   | 101053          | <b>Ref. No.</b><br>12019677<br>U264399 |
|                        | magnet unit T1: M9x1 T2: M24x1 L 45mm ø 17mm suitable for Minisit  |                 |  |
|                        | <b>GEV No.</b>   | 102107          | <b>Ref. No.</b>                        |
|                        | probe 100-340°C probe ø 4mm probe L 72mm capillary pipe 1050mm t.max. 340°C oven/grill probe type type C1 suitable for MINISIT 710   |                 |  |
| <b>accessories for</b> | 101435   |                 |  |
|                        | <b>GEV No.</b>   | 100809          | <b>Ref. No.</b>                        |
|                        | O-ring EPDM thickness 2mm ID ø 21mm Qty 1 pcs  |                 |  |
|                        | <b>GEV No.</b>   | 100904          | <b>Ref. No.</b>                        |
|                        | locking screw M10x1 for pipe ø 4mm Qty 1 pcs   |                 |  |
|                        | <b>GEV No.</b>   | 100905          | <b>Ref. No.</b><br>12008715<br>U134323 |
|                        | locking screw M10x1 for pipe ø 6mm Qty 1 pcs   |                 |  |
|                        | <b>GEV No.</b>   | 101054          | <b>Ref. No.</b>                        |
|                        | magnet unit T1: M10x1 T2: M24x1 L 45mm ø 17mm suitable for Minisit   |                 |  |
|                        | <b>GEV No.</b>   | 101136          | <b>Ref. No.</b>                        |
|                        | piezoelectric igniter suitable for Minisit with cover cap ømm connection F6.3x0.8  |                 |  |
|                        | <b>GEV No.</b>   | 101137          | <b>Ref. No.</b><br>12008932<br>U134318 |
|                        | cover cap without piezoelectric igniter  |                 |  |
|                        | <b>GEV No.</b>   | 101267          | <b>Ref. No.</b>                        |
|                        | reducer IT 3/8" ET 1/2" L 21mm   |                 |  |
|                        | <b>GEV No.</b>   | 101268          | <b>Ref. No.</b><br>12008944<br>U264300 |
|                        | gas connection thread 3/8" angled with O-ring MINISIT 710  |                 |  |
|                        | <b>GEV No.</b>   | 101269          | <b>Ref. No.</b>                        |
|                        | gas connection thread 1/2" angled with O-ring MINISIT 710  |                 |  |

|                        |  |        |  |
|------------------------|--|--------|--|
| <b>accessories for</b> | 101435   |        |  |
|                        | <b>GEV No.</b>   | 101270 | <b>Ref. No.</b>                        |
|                        | screw connection IT 3/8" ET 3/8" L 28mm                              |        |  |
|                        | <b>GEV No.</b>   | 101272 | <b>Ref. No.</b>                        |
|                        | screw connection IT 1/2" ET 3/8" L 57mm                              |        |  |
|                        | <b>GEV No.</b>   | 101273 | <b>Ref. No.</b><br>12008501<br>U055043 |
|                        | olive for pipe ø 12mm L 9.5mm brass Qty 1 pcs suitable for universal |        |  |
|                        | <b>GEV No.</b>   | 101274 | <b>Ref. No.</b>                        |
|                        | olive for pipe ø 16mm Qty 1 pcs                                      |        |  |
|                        | <b>GEV No.</b>   | 101275 | <b>Ref. No.</b><br>12008951<br>X012104 |
|                        | union screw thread 1/2" for pipe ø 16mm Qty 1 pcs                    |        |  |
|                        | <b>GEV No.</b>   | 101276 | <b>Ref. No.</b><br>12008081<br>U264310 |
|                        | union screw thread 3/8" tube ø 12mm Qty 1 pcs                        |        |  |
|                        | <b>GEV No.</b>   | 110068 | <b>Ref. No.</b><br>12008789<br>U134317 |
|                        | knob suitable for Minisit ø 37mm                                     |        |  |



|                        |   |                 |  |
|------------------------|---|-----------------|--|
| <b>GEV No.</b>         | 106332  | <b>Ref. No.</b> | 11U2643150<br>12003345<br>12007319     |
| <b>description</b>     | gas thermostat SIT type MINISIT 710 t.max. 340°C 100-340°C gas inlet 3/8" pipe input ø 12mm gas outlet 3/8" pipe output ø 12mm thermocouple connection M9x1 probe ø 4mm probe L 72mm pressure controller no |                 |  |
| <b>For models:</b>     | CG-1002, CG-1502, CG-2000, CG-2000-2P, CG-2002, CG9-11, CG9-41, CG9-51L, CG9-51LC, CG9-51R, CG9-51RC, CG9-61, CG9-82, FTG9-11L, FTG9-11L+R, FTG9-11R, FTGC9-11L, FTGC9-11L+R, FTGC9-11R                     |                 |  |
| <b>spare parts for</b> | 106332  |                 |  |
|                        | <b>GEV No.</b>  | 100809          | <b>Ref. No.</b>                        |
|                        | O-ring EPDM thickness 2mm ID ø 21mm Qty 1 pcs   |                 |  |
|                        | <b>GEV No.</b>  | 101053          | <b>Ref. No.</b><br>12019677<br>U264399 |
|                        | magnet unit T1: M9x1 T2: M24x1 L 45mm ø 17mm suitable for Minisit   |                 |  |
|                        | <b>GEV No.</b>  | 101137          | <b>Ref. No.</b><br>12008932<br>U134318 |
|                        | cover cap without piezoelectric igniter   |                 |  |
|                        | <b>GEV No.</b>  | 101268          | <b>Ref. No.</b><br>12008944<br>U264300 |
|                        | gas connection thread 3/8" angled with O-ring MINISIT 710   |                 |  |
|                        | <b>GEV No.</b>  | 102107          | <b>Ref. No.</b>                        |
|                        | probe 100-340°C probe ø 4mm probe L 72mm capillary pipe 1050mm t.max. 340°C oven/grill probe type type C1 suitable for MINISIT 710  |                 |  |
|                        | <b>GEV No.</b>  | 110068          | <b>Ref. No.</b><br>12008789<br>U134317 |
|                        | knob suitable for Minisit ø 37mm  |                 |  |

Table continues overleaf

1 gas components

Зип Общепит  
vsezip.ru  
+7(812)987-08-81

| accessories for |   | 106332 |                           |
|-----------------|---|--------|---------------------------|
|                 | GEV No.   | 100904 | Ref. No. 12008755         |
|                 | locking screw M10x1 for pipe ø 4mm Qty 1 pcs                                      |        |                           |
|                 | GEV No.   | 100905 | Ref. No. 12008715 U134323 |
|                 | locking screw M10x1 for pipe ø 6mm Qty 1 pcs                                      |        |                           |
|                 | GEV No.   | 101054 | Ref. No. —                |
|                 | magnet unit T1: M10x1 T2: M24x1 L 45mm ø 17mm suitable for Minisit                |        |                           |
|                 | GEV No.   | 101136 | Ref. No. —                |
|                 | piezoelectric igniter suitable for Minisit with cover cap ømm connection F6.3x0.8 |        |                           |
|                 | GEV No.   | 101267 | Ref. No. —                |
|                 | reducer IT 3/8" ET 1/2" L 21mm  |        |                           |
|                 | GEV No.   | 101269 | Ref. No. —                |
|                 | gas connection thread 1/2" angled with O-ring MINISIT 710                         |        |                           |
|                 | GEV No.   | 101270 | Ref. No. —                |
|                 | screw connection IT 3/8" ET 3/8" L 28mm   |        |                           |
|                 | GEV No.   | 101272 | Ref. No. —                |
|                 | screw connection IT 1/2" ET 3/8" L 57mm   |        |                           |
|                 | GEV No.   | 101273 | Ref. No. 12008501 U055043 |
|                 | olive for pipe ø 12mm L 9.5mm brass Qty 1 pcs suitable for universal              |        |                           |
|                 | GEV No.   | 101274 | Ref. No. X012105          |
|                 | olive for pipe ø 16mm Qty 1 pcs   |        |                           |
|                 | GEV No.   | 101275 | Ref. No. 12008951 X012104 |
|                 | union screw thread 1/2" for pipe ø 16mm Qty 1 pcs                                 |        |                           |
|                 | GEV No.   | 101276 | Ref. No. 12008081 U264310 |
|                 | union screw thread 3/8" tube ø 12mm Qty 1 pcs                                     |        |                           |

| accessories |   |          |                  |
|-------------|---|----------|------------------|
| probes      |   |          |                  |
|             | 1   |          |                  |
| GEV No.     | 102102  | Ref. No. | 12018712 U264398 |
| description | probe 100-340°C probe ø 5mm probe L 68mm capillary pipe 1750mm t.max. 340°C oven/grill probe type type B1 suitable for MINISIT 710  |          |                  |
| For models: | CG-1002, CG-1502, CG-2000, CG-2000-2P, CG-2002, CG9-11, CG9-41, CG9-51L, CG9-51LC, CG9-51R, CG9-51RC, CG9-61, CG9-82, FTG9-11L, FTG9-11L+R, FTG9-11R, FTGC9-11L, FTGC9-11L+R, FTGC9-11R |          |                  |

|                 | 1  |          |                  |
|-----------------|--|----------|------------------|
| GEV No.         | 102104 <sup>1</sup>  | Ref. No. | 12017711 X012198 |
| description     | probe 110-190°C probe ø 11mm probe thread 1/4" probe L 26mm capillary pipe 1050mm t.max. 190°C fryer probe type type F3 suitable for MINISIT 710 |          |                  |
| accessories for |  | 102104   |                  |
|                 | GEV No.  | 361182   | Ref. No. —       |
|                 | nut thread 1/4" H 5mm nickel-plated brass WS 17 Qty 1 pcs  |          |                  |
|                 | GEV No.  | 510420   | Ref. No. —       |
|                 | gasket copper ED ø 19.9mm ID ø 14.3mm thickness 2mm Qty 1 pcs  |          |                  |
|                 | GEV No.  | 529251   | Ref. No. —       |
|                 | O-ring EPDM thickness 2.62mm ID ø 15.08mm Qty 1 pcs  |          |                  |

<sup>1</sup>probe thread 1/4"

COPRECI

|                 | 1  |          |                                    |
|-----------------|--|----------|------------------------------------|
| GEV No.         | 101533   | Ref. No. | 12017423 R202104 R432102 U262102   |
| description     | gas thermostat COPRECI t.max. 110°C gas inlet pipe flange ø21mm bypass nozzle ø 0.35mm gas outlet 3/8" pilot connection 1/8" thermocouple connection M8x1 capillary pipe 1000mm probe ø 6mm probe L 135mm shaft ø 8x6.5mm shaft L 33/12mm shaft flat right |          |                                    |
| For models:     | BMG7-10, BMG9-05, BMG9-10, FTG7-05, FTG7-10  |          |                                    |
| spare parts for |  | 101533   |                                    |
|                 | GEV No.  | 101060   | Ref. No. 608205 608205000          |
|                 | magnet unit standard L 39mm D1 ø 15.4mm D2 ø 11mm suitable for PEL20-21/JUNKERS/EGA  |          |                                    |
|                 | GEV No.  | 101537   | Ref. No. 12010025 12017549 Q307034 |
|                 | gasket ID ø 8mm ED ø 11.5mm H 3mm Qty 1 pcs  |          |                                    |
| accessories for |  | 101533   |                                    |
|                 | GEV No.  | 101538   | Ref. No. 12025294 Z982018          |
|                 | clamp  |          |                                    |



Зип Общепит



vsezip.ru

+7(812)987-08-81







|   |   |                 |   |
|---|---|-----------------|---|
| <b>GEV No.</b>  | 109050  | <b>Ref. No.</b> | 12017437<br>U018700                             |
| <b>description</b>  | gas thermostat COPRECI t.max. 300°C gas inlet pipe flange ø21mm bypass nozzle ø 0.64mm gas outlet 3/8" pilot connection 1/8" thermocouple connection 2x M8x1 capillary pipe 1000mm probe ø 5mm probe L 110mm shaft ø 8x6.5mm shaft L 33/12mm shaft flat right |                 |   |
| <b>For models:</b>  | CG-210G, CG-310G  |                 |   |
| <b>spare parts for</b>  | 109050  |                 |   |
|  | <b>GEV No.</b>  | 101060          | <b>Ref. No.</b> 608205<br>608205000             |
|   | magnet unit standard L 39mm D1 ø 15.4mm D2 ø 11mm suitable for PEL20-21/JUNKERS/EGA   |                 |   |
|  | <b>GEV No.</b>  | 101537          | <b>Ref. No.</b> 12010025<br>12017549<br>Q307034 |
|   | gasket ID ø 8mm ED ø 11.5mm H 3mm Qty 1 pcs   |                 |   |
| <b>accessories for</b>  | 109050  |                 |   |
|  | <b>GEV No.</b>  | 101538          | <b>Ref. No.</b> 12025294<br>Z982018             |
|   | clamp   |                 |   |



|   |   |                 |  |
|---|---|-----------------|--|
| <b>GEV No.</b>  | 109051  | <b>Ref. No.</b> | 11R5321030<br>12012011<br>12012114<br>12017288<br>12040477<br>R532101<br>R612101 |
| <b>description</b>  | gas thermostat COPRECI t.max. 300°C gas inlet pipe flange ø21mm bypass nozzle ø 0.6mm gas outlet 3/8" pilot connection 1/8" thermocouple connection M8x1 capillary pipe 1100mm probe ø 4mm probe L 84mm shaft ø 8x6.5mm shaft L 33/12mm shaft flat right  |                 |  |
| <b>For models:</b>  | FTG9-05L, FTG9-05R, FTG9-05VL, FTG9-05VR, FTG9-10L, FTG9-10L+R, FTG9-10R, FTG9-10VL, FTG9-10VL+R, FTG9-10VR, FTG9-11L, FTG9-11L+R, FTG9-11R, FTGC9-05, FTGC-9050, FTGC9-05L, FTGC9-05R, FTGC9-10, FTGC-9100, FTGC9-10L, FTGC9-10L+R, FTGC9-10R, FTGC9-11L, FTGC9-11L+R, FTGC9-11R, PL-105C, PL-110C |                 |  |
| <b>spare parts for</b>  | 109051  |                 |  |
|  | <b>GEV No.</b>  | 101060          | <b>Ref. No.</b> 608205<br>608205000  |
|   | magnet unit standard L 39mm D1 ø 15.4mm D2 ø 11mm suitable for PEL20-21/JUNKERS/EGA   |                 |  |
|  | <b>GEV No.</b>  | 101537          | <b>Ref. No.</b> 12010025<br>12017549<br>Q307034                                  |
|   | gasket ID ø 8mm ED ø 11.5mm H 3mm Qty 1 pcs   |                 |  |
| <b>accessories for</b>  | 109051  |                 |  |
|  | <b>GEV No.</b>  | 101376          | <b>Ref. No.</b> —  |
|   | gasket ID ø 8mm ED ø 12mm H 3/5mm   |                 |  |

|   |                |        |                                     |
|---|----------------|--------|-------------------------------------|
| <b>accessories for</b>  | 109051         |        |                                     |
|  | <b>GEV No.</b> | 101538 | <b>Ref. No.</b> 12025294<br>Z982018 |
|   | clamp          |        |                                     |



|   |  |                 |   |
|---|--|-----------------|---|
| <b>GEV No.</b>  | 109534   | <b>Ref. No.</b> | 12009479<br>12015257<br>329200<br>R782130<br>U329200<br>U742130 |
| <b>description</b>  | gas thermostat COPRECI type CAL-5200 t.max. 300°C gas inlet pipe flange ø21mm bypass nozzle ø 0.5mm gas outlet 3/8" pilot connection closed thermocouple connection M8x1 capillary pipe 1100mm probe ø 4mm probe L 82mm shaft ø 8x6.5mm shaft L 33/12mm shaft flat right |                 |   |
| <b>For models:</b>  | CG-210, CG-210G, CG-310, CG-310G, CG6-41, CG7-11, CG-7115, CG7-41, CG-7415, CG7-61, CG-7615, CGB7-61, FTG7-05, FTG7-10, FTGC6-05L, FTGC6-10L, FTGC6-10L+R  |                 |   |
| <b>spare parts for</b>  | 109534   |                 |   |
|   | <b>GEV No.</b>   | 101060          | <b>Ref. No.</b> 608205<br>608205000                             |
|   | magnet unit standard L 39mm D1 ø 15.4mm D2 ø 11mm suitable for PEL20-21/JUNKERS/EGA  |                 |   |
| <b>accessories for</b>  | 109534   |                 |   |
|  | <b>GEV No.</b>   | 101537          | <b>Ref. No.</b> 12010025<br>12017549<br>Q307034                 |
|   | gasket ID ø 8mm ED ø 11.5mm H 3mm Qty 1 pcs  |                 |   |
|  | <b>GEV No.</b>   | 101538          | <b>Ref. No.</b> 12025294<br>Z982018                             |
|   | clamp  |                 |   |



|                    |  |                 |                     |
|--------------------|--|-----------------|---------------------|
| <b>GEV No.</b>     | 109112   | <b>Ref. No.</b> | 12007980<br>H352101 |
| <b>description</b> | gas thermostat COPRECI type MTZ22300 gas inlet pipe flange ø21mm bypass nozzle ø 0.5mm gas outlet M14x1.5 pilot connection 1/8" thermocouple connection M8x1 capillary pipe 850mm probe ø 6mm probe L 130mm shaft ø 8x6.5mm shaft L 42/12mm shaft flat right |                 |                     |
| <b>For models:</b> | BMG7-10, BMG9-05, BMG9-05V-T, BMG9-10, BMG9-10V-T  |                 |                     |

1 gas components



1 gas components

gas valves and ignition boxes

ЗипОбщепит

gas control valves

DUNGS



|                    |   |                 |                       |
|--------------------|---|-----------------|-----------------------|
| <b>GEV No.</b>     | 106050  | <b>Ref. No.</b> | 12026701<br>RT7000220 |
| <b>description</b> | gas valve 230V 50/60Hz gas inlet 1/2" gas outlet 1/2" DUNGS type GB 055 243 443 |                 |                       |



|                    |   |                 |                       |
|--------------------|---|-----------------|-----------------------|
| <b>GEV No.</b>     | 106051  | <b>Ref. No.</b> | 12026482<br>RT7000031 |
| <b>description</b> | gas valve 230V 50/60Hz gas inlet 1/2" gas outlet 1/2" DUNGS type GB-WND 055 243 442 |                 |                       |



|                    |   |                 |                       |
|--------------------|---|-----------------|-----------------------|
| <b>GEV No.</b>     | 107554  | <b>Ref. No.</b> | 12026440<br>RT7000029 |
| <b>description</b> | gas valve 230V 50/60Hz gas inlet 1/2" gas outlet 1/2" total length 105mm DUNGS type GB-WND 055 D01 S02 243442 |                 |                       |



|                    |  |                 |                       |
|--------------------|--|-----------------|-----------------------|
| <b>GEV No.</b>     | 107555   | <b>Ref. No.</b> | 12040554<br>RT7000033 |
| <b>description</b> | gas valve 230V 50/60Hz gas inlet 1/2" IT gas outlet 1/2" IT total length 105mm DUNGS type GB-ND 055 D01 S02 243443 |                 |                       |



|                        |   |                 |                        |
|------------------------|---|-----------------|------------------------|
| <b>GEV No.</b>         | 101186  | <b>Ref. No.</b> | 12027429<br>RT30390241 |
| <b>description</b>     | gas valve type VK4105C 220-240V 50/60Hz gas inlet flange 32x32mm gas outlet flange 32x32mm thermocouple connection pilot connection pressure range 15-60mbar max 60mbar operator type pressure controller type V5360E 1226 1 HONEYWELL flange 32x32mm |                 |                        |
| <b>accessories for</b> | 101186  |                 |                        |
|                        | <b>GEV No.</b>  | 102845          | <b>Ref. No.</b> —      |
|                        | gas connection angled 1/2" flange 32x32mm hole distance 24x24mm Tandem  |                 |                        |
|                        | <b>GEV No.</b>  | 102846          | <b>Ref. No.</b> —      |
|                        | gas connection straight 1/2" flange 32x32mm hole distance 24x24mm suitable for Tandem   |                 |                        |



|                        |  |                 |                     |
|------------------------|--|-----------------|---------------------|
| <b>GEV No.</b>         | 106420   | <b>Ref. No.</b> | 12024609<br>T303017 |
| <b>description</b>     | gas valve type VK4115V 220/240V 50/60Hz gas inlet 1/2" NPT gas outlet flange 32x32mm thermocouple connection pilot connection pressure range 15-60mbar max 60mbar operator type HONEYWELL flange 32x32mm |                 |                     |
| <b>For models:</b>     | COG-102, HGC-10-21, HGC-20-21, HGP-10-21, HGP-20-21, HGV-10-21, HGV-20-21, VG-102, VPG-102   |                 |                     |
| <b>accessories for</b> | 106420   |                 |                     |
|                        | <b>GEV No.</b>   | 102845          | <b>Ref. No.</b> —   |
|                        | gas connection angled 1/2" flange 32x32mm hole distance 24x24mm Tandem   |                 |                     |
|                        | <b>GEV No.</b>   | 102846          | <b>Ref. No.</b> —   |
|                        | gas connection straight 1/2" flange 32x32mm hole distance 24x24mm suitable for Tandem  |                 |                     |



Зип-Общепит

vsezip.ru

+7(812)987-08-81



1

|   |   |                 |                        |
|---|---|-----------------|------------------------|
| <b>GEV No.</b>  | 106054  | <b>Ref. No.</b> | 12027246<br>RT30390245 |
| <b>description</b>  | gas valve type VK4115V 220-240V 50/60Hz gas inlet flange 32x32mm gas outlet flange 32x32mm thermocouple connection pilot connection pressure range 15-60mbar operator type HONEYWELL flange 32x32mm |                 |                        |
| <b>accessories for</b>  | 106054  |                 |                        |
|  | <b>GEV No.</b>  | 102845          | <b>Ref. No.</b> —      |
|   | gas connection angled 1/2" flange 32x32mm hole distance 24x24mm Tandem  |                 |                        |
|  | <b>GEV No.</b>  | 102846          | <b>Ref. No.</b> —      |
|   | gas connection straight 1/2" flange 32x32mm hole distance 24x24mm suitable for Tandem   |                 |                        |



1

|                    |   |                 |                                    |
|--------------------|---|-----------------|------------------------------------|
| <b>GEV No.</b>     | 106417  | <b>Ref. No.</b> | 11T1350370<br>12003943<br>12038515 |
| <b>description</b> | gas valve type VR4605V LPG 230V 50Hz gas inlet 1/2" gas outlet 1/2" thermocouple connection pilot connection operator type 230V (V4346A 1006) |                 |                                    |
| <b>For models:</b> | COG-201, HCG-20-11, HGC-20-11, HGV-20-11, HVG-20-11, VG-201, VPG-201  |                 |                                    |











1

|                    |   |                 |                                 |
|--------------------|---|-----------------|---------------------------------|
| <b>GEV No.</b>     | 106419  | <b>Ref. No.</b> | 12003940<br>12038517<br>T115098 |
| <b>description</b> | gas valve type VR4605V natural gas 230V 50Hz gas inlet 1/2" gas outlet 1/2" thermocouple connection pilot connection operator type 230V (V4346A 1006) |                 |                                 |
| <b>For models:</b> | COG-101, HCG-10-11, HCG-10-21, HCG-2-10-11, HGC-10-11, HGV-10-11, HVG-10-11, HVG-10-21, HVG-2-10-11, VG-101, VPG-101                                  |                 |                                 |



1

|   |  |                 |                                     |
|---|--|-----------------|-------------------------------------|
| <b>GEV No.</b>  | 101127   | <b>Ref. No.</b> | R275003000                          |
| <b>description</b>  | gas valve SIT type ELETTROSIT 230V gas inlet 3/4" gas outlet 3/4" thermocouple connection M9x1 pilot connection M10x1 lateral equiv. no. 0.810.175 |                 |                                     |
| <b>spare parts for</b>  | 101127   |                 |                                     |
|    | <b>GEV No.</b>   | 101312          | <b>Ref. No.</b> 12024469<br>R275027 |
|   | microswitch  |                 |                                     |
|    | <b>GEV No.</b>   | 101352          | <b>Ref. No.</b> —                   |
|   | solenoid coil 230V 50Hz suitable for ELETTROSIT  |                 |                                     |
| <b>accessories for</b>  | 101127   |                 |                                     |
|   | <b>GEV No.</b>   | 100006          | <b>Ref. No.</b> T982001000          |
|   | piezoelectric igniter suitable for ELETTROSIT body plastic blowing connection ø2.4mm ø 14mm  |                 |                                     |
|  | <b>GEV No.</b>   | 100904          | <b>Ref. No.</b> 12008755            |
|   | locking screw M10x1 for pipe ø 4mm Qty 1 pcs   |                 |                                     |
|  | <b>GEV No.</b>   | 100905          | <b>Ref. No.</b> 12008715<br>U134323 |
|   | locking screw M10x1 for pipe ø 6mm Qty 1 pcs   |                 |                                     |
|  | <b>GEV No.</b>   | 101301          | <b>Ref. No.</b> —                   |
|   | gas connection thread 1/2" straight ELETTROSIT screw with O-ring   |                 |                                     |
|  | <b>GEV No.</b>   | 101303          | <b>Ref. No.</b> —                   |
|   | gas connection straight thread 3/4" ELETTROSIT   |                 |                                     |
|  | <b>GEV No.</b>   | 101309          | <b>Ref. No.</b> —                   |
|   | extension  |                 |                                     |

1 gas components



Зиг-Общепит

vsezip.ru

+7(812)987-08-81

**NOVASIT**



|                        |  |                 |                                     |
|------------------------|--|-----------------|-------------------------------------|
| <b>1</b>               |  |                 |                                     |
| <b>GEV No.</b>         | 101908   | <b>Ref. No.</b> | 12024768<br>12097292<br>X163000     |
| <b>description</b>     | gas valve SIT series Novasit 820 230V 50Hz gas inlet 1/2" gas outlet 1/2" thermocouple connection M9x1 pilot connection M10x1 ignition pressurebar pressure regulator connection blind equiv. no. 0.820.018 output pilot burner M10x1 input pressure max. 60bar setting range 3-30bar  |                 |                                     |
| <b>For models:</b>     | FG7-05-1C, FG7-05-2C, FG-710, FG7-10-2C, FG7-104C, FG7-10-4C, FG-720, FG9-05, FG9-05-1C, FG9-05-2C, FG9-05AD, FG9-05PLUS, FG9-05PLUS-S, FG9-05S, FG9-05S-1C, FG9-05S-2C, FG9-05S-AD, FG9-10, FG9-10-2C, FG9-10-4C, FG9-10AD, FG9-10PLUS, FG-920, FG-940, FGCL9-05, FGCL9-05-1C, FGCL9-05-2C, FGCL9-05S-1C, FGCL9-05S-2C, MG9-10AD, MG9-10BMAD, MG9-10BMSAD, MG9-10PLUS, MG9-10PLUS-BM, MG9-10PLUS-BMS, MG9-10PLUS-S, MG9-10S-AD, MG9-15AD, MG9-15BMAD, MG9-15BMSAD, MG9-15PLUS, MG9-15PLUS-BM, MG9-15PLUS-BMS, MG9-15PLUS-S, MG9-15S-AD, MG9-20AD, MG9-20PLUS, MG9-20PLUS-S, MG9-20S-AD, SBG7-10...(Other models you can see in the webshop) |                 |                                     |
| <b>spare parts for</b> | 101908   |                 |                                     |
|                        | <b>GEV No.</b>   | 101065          | <b>Ref. No.</b> 12033710<br>X163098 |
|                        | magnet unit with cable L 44mm D1 ø 30mm D2 ø 20mm suitable for NOVASIT   |                 |                                     |
|                        | <b>GEV No.</b>   | 101313          | <b>Ref. No.</b> 12018959<br>X163099 |
|                        | solenoid coil 230V 50Hz  |                 |                                     |
| <b>accessories for</b> | 101908   |                 |                                     |
|                        | <b>GEV No.</b>   | 100006          | <b>Ref. No.</b> T982001000          |
|                        | piezoelectric igniter suitable for ELETTROSIT body plastic blowing connection ø2.4mm ø 14mm  |                 |                                     |
|                        | <b>GEV No.</b>   | 101305          | <b>Ref. No.</b> 12020648<br>X153005 |
|                        | gas connection straight 1/2" flange 45x45mm ELETTROSIT/V4400/4600/4605 suitable for SIT/HONEYWELL hole distance 36x36mm  |                 |                                     |
|                        | <b>GEV No.</b>   | 101306          | <b>Ref. No.</b> 12009216<br>X153004 |
|                        | gas connection angled flange 45x45mm hole distance 36x36mm 1/2" ELETTROSIT/V4400/4600/4605 screw with O-ring suitable for SIT/HONEYWELL  |                 |                                     |
|                        | <b>GEV No.</b>   | 101307          | <b>Ref. No.</b> —                   |
|                        | gas connection straight flange 45x45mm hole distance 36x36mm 3/4" ELETTROSIT/V4400/4600/4605 screw with O-ring suitable for SIT/HONEYWELL  |                 |                                     |
|                        | <b>GEV No.</b>   | 101308          | <b>Ref. No.</b> —                   |
|                        | gas connection angled flange 45x45mm hole distance 36x36mm 3/4" ELETTROSIT/V4400/4600/4605 screw with O-ring suitable for SIT/HONEYWELL  |                 |                                     |
|                        | <b>GEV No.</b>   | 101312          | <b>Ref. No.</b> 12024469<br>R275027 |
|                        | microswitch  |                 |                                     |
|                        | <b>GEV No.</b>   | 101314          | <b>Ref. No.</b> —                   |
|                        | solenoid coil 24V 50Hz   |                 |                                     |

|  |  |        |                 |                     |
|--|--|--------|-----------------|---------------------|
|  | <b>GEV No.</b>                                   | 101317 | <b>Ref. No.</b> | 12024504<br>X163008 |
|  | pig with cable L 1000mm suitable for NOVASIT     |        |                 |                     |
|  | <b>GEV No.</b>                                   | 101318 | <b>Ref. No.</b> | —                   |
|  | cover cap for solenoid coil suitable for NOVASIT |        |                 |                     |

**SIGMA**



|                    |  |                 |          |
|--------------------|--|-----------------|----------|
| <b>1</b>           |  |                 |          |
| <b>GEV No.</b>     | 107926   | <b>Ref. No.</b> | 12046364 |
| <b>description</b> | gas valve type 0848160 230V 50Hz gas inlet 3/4" gas outlet 3/4" pressure range 0.5-12mbar SIT equiv. no. 0848160                 |                 |          |
| <b>For models:</b> | ACG-061, ACG-101, ACG-102, ACG-201, ACG-202, AG-061, AG-101, AG-102, AG-201, AG-202, APG-061, APG-101, APG-102, APG-201, APG-202 |                 |          |

**TANDEM**





|                        |  |                 |                                     |
|------------------------|--|-----------------|-------------------------------------|
| <b>1</b>               |  |                 |                                     |
| <b>GEV No.</b>         | 101684   | <b>Ref. No.</b> | 12023419<br>Z952201                 |
| <b>description</b>     | gas valve 230V 50Hz gas inlet 1/2" gas outlet 1/2" pilot connection level slow ignition standard ignition time 3-7s pressure range 3-50mbar power supply for modulator type SIT equiv. no. 0.830.034   |                 |                                     |
| <b>For models:</b>     | GA-20, GA-40, HCG-10-11, HCG-10-21, HCG-20-11, HCG-2-10-11, HCG-6-11, HGV-10-11, HGV-20-11, HMG-10-11, HMG-10-21, HMG-20-11, HMG-2-10-11, HMG-6-11, HVG-10-11, HVG-10-21, HVG-20-11, HVG-2-10-11, HVG-2-10-11, HVG-2-20-21, VG-101, VG-201, VPG-101, VPG-201 |                 |                                     |
| <b>spare parts for</b> | 101684   |                 |                                     |
|                        | <b>GEV No.</b>   | 101379          | <b>Ref. No.</b> —                   |
|                        | solenoid coil 230V 50Hz suitable for Tandem  |                 |                                     |
| <b>accessories for</b> | 101684   |                 |                                     |
|                        | <b>GEV No.</b>   | 101274          | <b>Ref. No.</b> X012105             |
|                        | olive for pipe ø 16mm Qty 1 pcs  |                 |                                     |
|                        | <b>GEV No.</b>   | 101275          | <b>Ref. No.</b> 12008951<br>X012104 |
|                        | union screw thread 1/2" for pipe ø 16mm Qty 1 pcs  |                 |                                     |
|                        | <b>GEV No.</b>   | 102845          | <b>Ref. No.</b> —                   |
|                        | gas connection angled 1/2" flange 32x32mm hole distance 24x24mm Tandem   |                 |                                     |

Table continues overleaf





|   |   |        |            |
|---|---|--------|------------|
| accessories for   | 101684  |        |            |
|  | GEV No.   | 102846 | Ref. No. — |
|   | gas connection straight 1/2" flange 32x32mm hole distance 24x24mm suitable for Tandem |        |            |
|  | GEV No.   | 102847 | Ref. No. — |
|   | O-ring  |        |            |

Зип Общепит

honeywell

vsezip.ru

+7(812)987-08-81

ignition boxes

HONEYWELL

Honeywell



1

|             |   |          |                        |
|-------------|---|----------|------------------------|
| GEV No.     | 102381  | Ref. No. | 12026363<br>RT30390107 |
| description | ignition box HONEYWELL type S4565BD 1064 electrodes 3 waiting times safety time 5s 220-240V 4VA 50/60Hz |          |                        |

Honeywell



1

|             |   |          |                                   |
|-------------|---|----------|-----------------------------------|
| GEV No.     | 103330  | Ref. No. | 12023720<br>T303013<br>T303013000 |
| description | ignition box HONEYWELL type S4565BD 2005U electrodes 3 waiting times safety time 5s 220-240V 4VA 50/60Hz                                  |          |                                   |
| For models: | COG-102, GA-20, GA-20D, GA-40, GA-40D, HGC-10-21, HGC-20-21, HGP-10-21, HGP-20-21, HGV-10-21, HGV-20-21, VG-102, VG-202, VPG-102, VPG-202 |          |                                   |

Honeywell



1

|             |   |          |                        |
|-------------|---|----------|------------------------|
| GEV No.     | 101184  | Ref. No. | 12027187<br>RT30390105 |
| description | ignition box HONEYWELL type S4565C 1033 equiv. no. S4565C 1033 electrodes 2 waiting times safety time 5s 220-240V 4VA 50/60Hz |          |                        |

1

|             |  |          |                        |
|-------------|--|----------|------------------------|
| GEV No.     | 104598   | Ref. No. | 12027445<br>DO1AB01416 |
| description | ignition box HONEYWELL type S4565XXXX electrodes 3 waiting times safety time 10s 220-240V 4VA 50/60Hz  |          |                        |
| For models: | SF-10, SF-10MP, SF-10MPP, SF-13, SF-15, SF-15MP, SF-15MPP, SF-22, SF-22MP, SF-22MPP, SF-31, SF-31MP, SF-31MPP, SF-8, SR-10MP-PSM, SR-13MP-PSM, SR-32MP-PSM |          |                        |

SIT



1

|             |  |          |                        |
|-------------|--|----------|------------------------|
| GEV No.     | 107497   | Ref. No. | 12039440<br>T643002000 |
| description | ignition box SIT type 579DBC electrodes 1 waiting time 1s safety time 5s 220/240V 12VA 50/60Hz |          |                        |

miscellaneous



1

|             |                                |          |                       |
|-------------|--------------------------------|----------|-----------------------|
| GEV No.     | 102380                         | Ref. No. | 12026073<br>RT7400221 |
| description | ignition box type 3a9PHC070-R1 |          |                       |

White Rodgers



1

|             |  |          |                     |
|-------------|--|----------|---------------------|
| GEV No.     | 101377   | Ref. No. | 12016821<br>R723010 |
| description | ignition box WHITE RODGERS type 50A72-213 waiting time 0s safety time 2s |          |                     |
| For models: | HCG-10-11, HCG-10-21, HCG-2-10-11, HMG-10-11, HMG-10-21, HMG-2-10-11     |          |                     |



|   |  |                 |                     |
|---|--|-----------------|---------------------|
|  |  |                 |                     |
| <b>GEV No.</b>  | 101569   | <b>Ref. No.</b> | 12016800<br>R723032 |
| <b>description</b>  | ignition box WHITE RODGERS type 50A72-250-04 waiting time 0s safety time 5s 220/240V 50/60Hz   |                 |                     |
| <b>For models:</b>  | HCG-10-11, HCG-10-21, HCG-20-11, HCG-2-10-11, HCG-6-11, HMG-10-11, HMG-10-11UL, HMG-10-21, HMG-10-21UL, HMG-20-11, HMG-2-10-11, HMG-6-11 |                 |                     |

## ignition parts

### pilot burners



#### SIT

#### 100 series



|   |   |                 |                                    |
|---|---|-----------------|------------------------------------|
|  |   |                 |                                    |
| <b>GEV No.</b>  | 102445  | <b>Ref. No.</b> | 11U4421340<br>12003282<br>12004905 |
| <b>description</b>  | pilot burner SIT type 100 series 2 flames nozzle $\phi$ 0.25mm gas connection 4mm   |                 |                                    |
| <b>For models:</b>  | CG-1002, CG-1502, CG-2000, CG-2000-2P, CG-2002, CG-2002P, CG-200S, CG-210, CG-210G, CG-300S, CG-310, CG-310G, CG7-20, CG-7200, CG7-40, CG-7400, CG7-41, CG-7415, CG7-61, CG-7615, CG9-20, CG9-40, CG9-41, CG9-51L, CG9-51LC, CG9-51R, CG9-51RC, CG9-60, CG9-61, CG9-82, CGB7-61, CGE7-100, CGE7-41, CGE9-41, CGF9-120D, CGF9-120I, CGF9-121D, CGF9-121I |                 |                                    |







|   |   |                 |   |
|---|---|-----------------|---|
|  |   |                 |   |
| <b>GEV No.</b>  | 106906  | <b>Ref. No.</b> | 12009166<br>12034540<br>FX30100005<br>U322118 |
| <b>description</b>  | pilot burner SIT type 100 series 3 flames nozzle $\phi$ 0.2mm gas connection 6mm  |                 |   |
| <b>For models:</b>  | BG7-05, BG7-05I, BG7-10, BG7-10I, BG9-05, BG9-05AD, BG9-05I, BG9-05PF, BG9-05PI, BG9-05PLUS-I, BG9-10, BG9-10AD, BG9-10I, BG9-10PF, BG9-10PI, BG9-10PLUS-I, BMG7-10, BMG-9045, CG-1002, CG-1502, CG-2000, CG-2000-2P, CG-2002, CG-2002P, CG6-41, CG7-11, CG-7115, CG7-31D, CG7-31I, CG7-41, CG-7415, CG7-41H, CG7-51, CG7-61, CG-7615, CG7-61H, CG9-11, CG-9110, CG9-11AD, CG9-11PLUS, CG9-31PLUS-D, CG9-31PLUS-I, CG9-41, CG9-41AD, CG9-41AD-H, CG9-41H, CG9-41PLUS, CG9-41PLUS-H, CG9-51L, CG9-51LC...(Other models you can see in the webshop) |                 |   |
| <b>spare parts for</b>  | 106906  |                 |   |
|  | <b>GEV No.</b>  | 100245          | <b>Ref. No.</b>                               |
|   |   |                 | 12021187<br>U442138                           |
|   | pilot burner nozzle LPG code 20 bore $\phi$ 0.2mm Qty 1 pcs thread M8x0.75  |                 |   |

Зип-Общепит

vsezip.ru

+7(812)9870808

|   |   |        |                 |                     |
|---|---|--------|-----------------|---------------------|
|    | <b>GEV No.</b>  | 100855 | <b>Ref. No.</b> | —                   |
|   | pilot burner bracket triple   |        |                 |                     |
|    | <b>GEV No.</b>  | 100885 | <b>Ref. No.</b> | 12008510<br>X012122 |
|   | air mixing sleeve for pilot burner Qty 1 pcs                                |        |                 |                     |
|    | <b>GEV No.</b>  | 100916 | <b>Ref. No.</b> | —                   |
|   | compression spring for pilot burner Qty 1 pcs                               |        |                 |                     |
|    | <b>GEV No.</b>  | 100917 | <b>Ref. No.</b> | —                   |
|   | gasket for pilot burner Qty 1 pcs aluminium                                 |        |                 |                     |
|    | <b>GEV No.</b>  | 100918 | <b>Ref. No.</b> | —                   |
|   | screw for pilot burner  |        |                 |                     |
|    | <b>GEV No.</b>  | 107162 | <b>Ref. No.</b> | —                   |
|   | pilot burner cap SIT 3 flames Hmm Lmm Qty 1 pcs                             |        |                 |                     |
|    | <b>GEV No.</b>  | 107701 | <b>Ref. No.</b> | 12009076<br>X012126 |
|   | pilot burner bottom part SIT 100 series nozzle $\phi$ 0.2mm                 |        |                 |                     |
| <b>accessories for</b>  | 106906  |        |                 |                     |
|    | <b>GEV No.</b>  | 100245 | <b>Ref. No.</b> | 12021187<br>U442138 |
|   | pilot burner nozzle LPG code 20 bore $\phi$ 0.2mm Qty 1 pcs thread M8x0.75  |        |                 |                     |
|  | <b>GEV No.</b>  | 100246 | <b>Ref. No.</b> | —                   |
|   | pilot burner nozzle natural gas bore $\phi$ 0.35mm Qty 1 pcs thread M8x0.75 |        |                 |                     |
|  | <b>GEV No.</b>  | 100904 | <b>Ref. No.</b> | 12008755            |
|   | locking screw M10x1 for pipe $\phi$ 4mm Qty 1 pcs                           |        |                 |                     |
|  | <b>GEV No.</b>  | 100905 | <b>Ref. No.</b> | 12008715<br>U134323 |
|   | locking screw M10x1 for pipe $\phi$ 6mm Qty 1 pcs                           |        |                 |                     |
|  | <b>GEV No.</b>  | 102110 | <b>Ref. No.</b> | 12019428            |
|   | pilot tube copper pipe $\phi$ 4mm thickness 1mm L 3000mm                    |        |                 |                     |
|  | <b>GEV No.</b>  | 102111 | <b>Ref. No.</b> | —                   |
|   | pilot tube copper pipe $\phi$ 6mm thickness 1mm L 3000mm                    |        |                 |                     |
|  | <b>GEV No.</b>  | 107171 | <b>Ref. No.</b> | —                   |
|   | pilot burner nozzle SIT natural/liquid gas bore $\phi$ 0.25mm Qty 1 pcs     |        |                 |                     |
|  | <b>GEV No.</b>  | 107700 | <b>Ref. No.</b> | —                   |
|   | pilot burner bottom part SIT 100 series nozzle $\phi$ 0.25mm                |        |                 |                     |
|  | <b>GEV No.</b>  | 107702 | <b>Ref. No.</b> | —                   |
|   | pilot burner bottom part SIT 100 series nozzle $\phi$ 0.35mm                |        |                 |                     |





Зип-Общепит





vsezip.ru







+7(812)987-08-81

1 gas components

|   |   |                 |                     |
|---|---|-----------------|---------------------|
| accessories   |   |                 |                     |
| pilot burner caps   |   |                 |                     |
|  |   |                 |                     |
| 1   |   |                 |                     |
| <b>GEV No.</b>  | 100837  | <b>Ref. No.</b> | 12009152<br>X012117 |
| <b>description</b>  | pilot burner cap 3 flames H 24mm L 48mm Qty 1 pcs   |                 |                     |
| <b>For models:</b>  | FG7-05-1C, FG7-05-2C, FG-710, FG7-10-2C, FG7-104C, FG7-10-4C, FG-71-15, FG-720, FG-72-30, FG9-05, FG9-05-1C, FG9-05-2C, FG9-05AD, FG9-05PLUS, FG9-05PLUS-S, FG9-05S, FG9-05S-1C, FG9-05S-2C, FG9-05S-AD, FG9-10, FG9-10-2C, FG9-10-4C, FG9-10AD, FG9-10PLUS, FG-91-20, FG-920, FG-92-40, FG-940 |                 |                     |

|   |   |                 |                     |
|---|---|-----------------|---------------------|
|  |   |                 |                     |
| 1   |   |                 |                     |
| <b>GEV No.</b>  | 102665  | <b>Ref. No.</b> | 12009214<br>X502103 |
| <b>description</b>  | pilot burner cap 3 flames suitable for 100 series H 28mm L 87mm Qty 1 pcs |                 |                     |
| <b>For models:</b>  | FGCL9-05, FGCL9-05-1C, FGCL9-05-2C, FGCL9-05S-1C, FGCL9-05S-2C            |                 |                     |

|   |   |                 |                     |
|---|---|-----------------|---------------------|
| pilot burner bottom parts   |   |                 |                     |
|  |   |                 |                     |
| 1   |   |                 |                     |
| <b>GEV No.</b>  | 107701  | <b>Ref. No.</b> | 12009076<br>X012126 |
| <b>description</b>  | pilot burner bottom part SIT 100 series nozzle ø 0.2mm  |                 |                     |
| <b>For models:</b>  | CG-1002, CG-1502, CG-2002, CG-2002P, CG7-20, CG7-20H, CG7-30D, CG7-30I, CG7-31D, CG7-31I, CG7-40, CG7-40H, CG7-41, CG7-41H, CG7-50, CG7-51, CG7-60, CG7-60H, CG7-61, CG7-61H, CG9-20, CG9-20H, CG9-40, CG9-40H, CG9-41, CG9-41H, CG9-51L, CG9-51LC, CG9-51R, CG9-51RC, CG9-60, CG9-60H, CG9-61, CG9-61H, CG9-61OP, CG9-82, CGB7-61, CGB7-61H, CGB7-61R, CGB7-61RH, CGE7-41, CGE7-41H, CGE9-41, CGE9-41H, CGF9-120D, CGF9-120I, CGF9-121D, CGF9-121I, FG7-05-1C, FG7-05-2C, FG-710...(Other models you can see in the webshop) |                 |                     |
| <b>spare parts for</b>  | 107701  |                 |                     |
|  | <b>GEV No.</b>  | 100245          | <b>Ref. No.</b>     |
|   |   |                 | 12021187<br>U442138 |
|   | pilot burner nozzle LPG code 20 bore ø 0.2mm Qty 1 pcs thread M8x0.75   |                 |                     |
|  | <b>GEV No.</b>  | 100916          | <b>Ref. No.</b>     |
|   |   |                 | —                   |
|   | compression spring for pilot burner Qty 1 pcs   |                 |                     |
|  | <b>GEV No.</b>  | 100917          | <b>Ref. No.</b>     |
|   |   |                 | —                   |
|   | gasket for pilot burner Qty 1 pcs aluminium   |                 |                     |
|  | <b>GEV No.</b>  | 100918          | <b>Ref. No.</b>     |
|   |   |                 | —                   |
|   | screw for pilot burner  |                 |                     |

|   |  |                 |                     |
|---|--|-----------------|---------------------|
| accessories   |  |                 |                     |
| 107701  |  |                 |                     |
| <b>GEV No.</b>  | 100246   | <b>Ref. No.</b> | —                   |
|   |  |                 |                     |
|  | pilot burner nozzle natural gas bore ø 0.35mm Qty 1 pcs thread M8x0.75 |                 |                     |
| <b>GEV No.</b>  | 100904   | <b>Ref. No.</b> | 12008755            |
|   |  |                 |                     |
|  | locking screw M10x1 for pipe ø 4mm Qty 1 pcs                           |                 |                     |
| <b>GEV No.</b>  | 100905   | <b>Ref. No.</b> | 12008715<br>U134323 |
|   |  |                 |                     |
|  | locking screw M10x1 for pipe ø 6mm Qty 1 pcs                           |                 |                     |
| <b>GEV No.</b>  | 102110   | <b>Ref. No.</b> | 12019428            |
|   |  |                 |                     |
|  | pilot tube copper pipe ø 4mm thickness 1mm L 3000mm                    |                 |                     |
| <b>GEV No.</b>  | 102111   | <b>Ref. No.</b> | —                   |
|   |  |                 |                     |
|  | pilot tube copper pipe ø 6mm thickness 1mm L 3000mm                    |                 |                     |
| <b>GEV No.</b>  | 102742   | <b>Ref. No.</b> | —                   |
|   |  |                 |                     |
|  | pilot burner nozzle LPG code 25 bore ø 0.25mm Qty 1 pcs                |                 |                     |

|  |  |                 |                     |
|--|--|-----------------|---------------------|
|  |  |                 |                     |
| 1  |  |                 |                     |
| <b>GEV No.</b>   | 100880   | <b>Ref. No.</b> | 12009075<br>U442136 |
| <b>description</b>   | pilot burner bottom part SIT 100 series nozzle ø 0.4mm   |                 |                     |
| <b>For models:</b>   | CG7-20, CG7-20H, CG7-30D, CG7-30I, CG7-31D, CG7-31I, CG7-40, CG7-40H, CG7-41, CG7-41H, CG7-50, CG7-51, CG7-60, CG7-60H, CG7-61, CG7-61H, CG9-20, CG9-20H, CG9-40, CG9-40H, CG9-41, CG9-41H, CG9-60, CG9-60H, CG9-61, CG9-61H, CG9-61OP, CG9-82, CGB7-61, CGB7-61H, CGB7-61R, CGB7-61RH, CGE7-41, CGE7-41H, CGE9-41, FG7-05-1C, FG7-05-2C, FG7-10-2C, FG7-104C, FG7-10-4C, FG9-05-1C, FG9-05-2C, FG9-05S-1C, FG9-05S-2C, FG9-10-2C, FG9-10-4C |                 |                     |

|  |   |                 |                     |
|--|---|-----------------|---------------------|
| pilot burner brackets  |   |                 |                     |
| universal  |   |                 |                     |
|  |   |                 |                     |
| 1  |   |                 |                     |
| <b>GEV No.</b>   | 100887  | <b>Ref. No.</b> | 12008620<br>X012114 |
| <b>description</b>   | opposite support for pilot burner suitable for 100 series   |                 |                     |
| <b>For models:</b>   | FG7-05-1C, FG7-05-2C, FG-710, FG7-10-2C, FG7-104C, FG7-10-4C, FG-71-15, FG-720, FG-72-30, FG9-05, FG9-05-1C, FG9-05-2C, FG9-05AD, FG9-05PLUS, FG9-05PLUS-S, FG9-05S, FG9-05S-1C, FG9-05S-2C, FG9-05S-AD, FG9-10, FG9-10-2C, FG9-10-4C, FG9-10AD, FG9-10PLUS, FG-91-20, FG-920, FG-92-40, FG-940 |                 |                     |

Зип Общежит

vsezip.ru

7(812)987-08-81

|   |   |                 |                     |
|---|---|-----------------|---------------------|
|  |   |                 |                     |
| 1   |   |                 |                     |
| <b>GEV No.</b>  | 100886  | <b>Ref. No.</b> | 12008676<br>X012113 |
| <b>description</b>  | pilot burner bracket suitable for 100 series 3-piece  |                 |                     |
| <b>For models:</b>  | FG7-05-1C, FG7-05-2C, FG-710, FG7-10-2C, FG7-104C, FG7-10-4C, FG-71-15, FG-720, FG-72-30, FG9-05, FG9-05-1C, FG9-05-2C, FG9-05AD, FG9-05PLUS, FG9-05PLUS-S, FG9-05S, FG9-05S-1C, FG9-05S-2C, FG9-05S-AD, FG9-10, FG9-10-2C, FG9-10-4C, FG9-10AD, FG9-10PLUS, FG-91-20, FG-920, FG-92-40, FG-940 |                 |                     |

|   |   |                 |                     |
|---|---|-----------------|---------------------|
|  |   |                 |                     |
| 2   |   |                 |                     |
| <b>GEV No.</b>  | 100888  | <b>Ref. No.</b> | 12008458<br>X012116 |
| <b>description</b>  | screw bolt for pilot burner   |                 |                     |
| <b>For models:</b>  | CG-1002, CG-1502, CG-2002, CG-2002P, CG7-20, CG7-20H, CG7-30D, CG7-30I, CG7-31D, CG7-31I, CG7-40, CG7-40H, CG7-41, CG7-41H, CG7-50, CG7-51, CG7-60, CG7-60H, CG7-61, CG7-61H, CG9-20, CG9-20H, CG9-40, CG9-40H, CG9-41, CG9-41H, CG9-51L, CG9-51LC, CG9-51R, CG9-51RC, CG9-60, CG9-60H, CG9-61, CG9-61H, CG9-61OP, CG9-82, CGB7-61, CGB7-61H, CGB7-61R, CGB7-61RH, CGE7-41, CGE7-41H, CGE9-41, CGF9-120D, CGF9-120I, CGF9-121D, CGF9-121I, FG7-05-1C, FG7-05-2C, FG-710...(Other models you can see in the webshop) |                 |                     |

producer-specific

|   |  |                 |                     |
|---|--|-----------------|---------------------|
|  |  |                 |                     |
| 1   |  |                 |                     |
| <b>GEV No.</b>  | 101022   | <b>Ref. No.</b> | 12011611<br>U745418 |
| <b>description</b>  | pilot burner bracket                             |                 |                     |
| <b>For models:</b>  | CG7-20, CG7-40, CG7-41, CG7-61, CGB7-61, CGE7-41 |                 |                     |

|   |  |                 |                     |
|---|--|-----------------|---------------------|
|  |  |                 |                     |
| 1   |  |                 |                     |
| <b>GEV No.</b>  | 104742                                       | <b>Ref. No.</b> | 12002362<br>R302130 |
| <b>description</b>  | pilot burner bracket suitable for 100 series |                 |                     |
| <b>For models:</b>  | HP-G-15, HPG-15                              |                 |                     |

|   |   |                 |                     |
|---|---|-----------------|---------------------|
|  |   |                 |                     |
| 1   |   |                 |                     |
| <b>GEV No.</b>  | 100245  | <b>Ref. No.</b> | 12021187<br>U442138 |
| <b>description</b>  | pilot burner nozzle LPG code 20 bore ø 0.2mm Qty 1 pcs thread Mx0.75  |                 |                     |
| <b>For models:</b>  | BG7-05, BG7-05I, BG7-10, BG7-10I, BG9-05, BG9-05I, BG9-10, BG9-10I, BMG7-10, BMG9-05, BMG9-10, CG-1002, CG-1502, CG-2002, CG-200S, CG-210, CG-210G, CG-300S, CG-310, CG-310G, CG7-10, CG7-11, CG7-20, CG7-40, CG7-41, CG7-61, CG9-10, CG9-11, CG9-20, CG9-40, CG9-41, CG9-51L, CG9-51LC, CG9-51R, CG9-51RC, CG9-60, CG9-61, CG9-82, CGB7-61, CGE7-41, CGE9-41, CGF9-120D, CGF9-120I, CGF9-121D, CGF9-121I, CGP9-11, CPG7-05, CPG9-05, CPG9-05NC, CPG9-05S...(Other models you can see in the webshop) |                 |                     |

|   |  |                 |                     |
|---|--|-----------------|---------------------|
|  |  |                 |                     |
| 1   |  |                 |                     |
| <b>GEV No.</b>  | 102972   | <b>Ref. No.</b> | 12008938<br>U442137 |
| <b>description</b>  | pilot burner nozzle natural gas code 40 bore ø 0.4mm Qty 1 pcs   |                 |                     |
| <b>For models:</b>  | BG6-05I, BG7-05, BG7-05I, BG7-10, BG7-10I, BG9-05, BG9-05AD, BG9-05I, BG9-05PF, BG9-05PI, BG9-05PLUS-I, BG9-10, BG9-10AD, BG9-10I, BG9-10PF, BG9-10PI, BG9-10PLUS-I, BMG7-10, BMG9-05, BMG9-05V-T, BMG9-10, BMG9-10V-T, CG-1002, CG-1502, CG-2002, CG-2002P, CG-200S, CG-210, CG-210G, CG-300S, CG-310, CG-310G, CG7-10, CG7-11, CG7-20, CG7-20H, CG7-30D, CG7-30I, CG7-31D, CG7-31I, CG7-40, CG7-40H, CG7-41, CG7-41H, CG7-50, CG7-51, CG7-60, CG7-60H, CG7-61, CG7-61H...(Other models you can see in the webshop) |                 |                     |

ignition electrodes

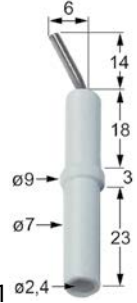
|   |  |                 |                     |
|---|--|-----------------|---------------------|
|  |  |                 |                     |
| 1   |  |                 |                     |
| <b>GEV No.</b>  | 100707   | <b>Ref. No.</b> | 12008994<br>X012101 |
| <b>description</b>  | ignition electrode D1 ø 7mm D2 ø 9mm connection ø2.4mm L1 14mm L2 6mm BL1 18mm BL2 3mm BL3 23mm to clip Qty 1 pcs  |                 |                     |
| <b>For models:</b>  | BG7-05, BG7-05I, BG7-10, BG7-10I, BG9-05, BG9-05I, BG9-10, BG9-10I, BMG-9045, BMG9-05, BMG9-10, CG-1002, CG-110, CG-1502, CG-2000, CG-2000-2P, CG-2002, CG-7115, CG-7415, CG-7615, CG9-05AD, CG9-05PLUS, CG9-10, CG9-11, CG-9110, CG9-20AD, CG9-20AD-H, CG9-20PLUS, CG9-20PLUS-H, CG9-31PLUS-D, CG9-31PLUS-I, CG9-40AD, CG9-40AD-H, CG9-40PLUS, CG9-40PLUS-H, CG9-41, CG9-41AD, CG9-41AD-H, CG9-41PLUS, CG9-41PLUS-H, CG9-51L, CG9-51LC, CG9-51R, CG9-51RC, CG9-60AD, CG9-60AD-H, CG9-60PLUS, CG9-60PLUS-H, CG9-61, CG9-61AD...(Other models you can see in the webshop) |                 |                     |



Зип-Общепит

vsezip.ru







81(2)987-08-81

|   |   |                 |                     |
|---|---|-----------------|---------------------|
| miscellaneous   |   |                 |                     |
|  |   |                 |                     |
| <b>GEV No.</b>  | 100885  | <b>Ref. No.</b> | 12008510<br>X012122 |
| <b>description</b>  | air mixing sleeve for pilot burner Qty 1 pcs  |                 |                     |
| <b>For models:</b>  | CG-1002, CG-1502, CG-2002, CG-2002P, CG7-20, CG7-20H, CG7-30D, CG7-30I, CG7-31D, CG7-31I, CG7-40, CG7-40H, CG7-41, CG7-41H, CG7-50, CG7-51, CG7-60, CG7-60H, CG7-61, CG7-61H, CG9-20, CG9-20H, CG9-40, CG9-40H, CG9-41, CG9-41H, CG9-51L, CG9-51LC, CG9-51R, CG9-51RC, CG9-60, CG9-60H, CG9-61, CG9-61H, CG9-61OP, CG9-82, CGB7-61, CGB7-61H, CGB7-61R, CGB7-61RH, CGE7-41, CGE7-41H, CGE9-41, CGF9-120D, CGF9-120I, CGF9-121D, CGF9-121I, FG7-05-1C, FG7-05-2C, FG-710...(Other models you can see in the webshop) |                 |                     |

|  |  |                 |                      |
|--|--|-----------------|----------------------|
|  |  |                 |                      |
| <b>GEV No.</b>   | 102876   | <b>Ref. No.</b> | 12040640<br>ICR10042 |
| <b>description</b>   | pilot burner POLIDORO 3 flames code gas connection 6mm |                 |                      |

**POLIDORO**

**pilot burners**

|   |  |                 |  |
|---|--|-----------------|--|
|    |  |                 |  |
| <b>GEV No.</b>  | 102800   | <b>Ref. No.</b> | 12037976<br>ICR08122                                       |
| <b>description</b>  | pilot burner POLIDORO 3 flames code gas connection 6mm                     |                 |  |
| <b>spare parts for</b>  | 102800   |                 |  |
|  | <b>GEV No.</b>   | 100906          | <b>Ref. No.</b> —  |
|   | screw connection thread M10x1 for ignition electrode brass Qty 1 pcs WS 10 |                 |  |
|  | <b>GEV No.</b>   | 100907          | <b>Ref. No.</b> —  |
|   | screw connection thread M10x1 Qty 1 pcs type SEF 1 0mm for thermocouple    |                 |  |
|  | <b>GEV No.</b>   | 100909          | <b>Ref. No.</b> 12008740<br>12016658<br>S312107<br>U265703 |
|   | union screw thread M10x1 for pipe ø 6mm Qty 1 pcs                          |                 |  |
|  | <b>GEV No.</b>   | 101287          | <b>Ref. No.</b> —  |
|   | olive for pipe ø 6mm Qty 1 pcs   |                 |  |
| <b>accessories for</b>  | 102800   |                 |  |
|  | <b>GEV No.</b>   | 100208          | <b>Ref. No.</b> —  |
|   | pilot burner nozzle POLIDORO LPG code 20 bore ø 0.2mm Qty 1 pcs            |                 |  |
|  | <b>GEV No.</b>   | 100209          | <b>Ref. No.</b> —  |
|   | pilot burner nozzle POLIDORO natural gas code 40 bore ø 0.4mm Qty 1 pcs    |                 |  |
|  | <b>GEV No.</b>   | 100701          | <b>Ref. No.</b> —  |
|   | ignition electrode connection M4 Qty 1 pcs                                 |                 |  |
|  | <b>GEV No.</b>   | 100908          | <b>Ref. No.</b> 12017481<br>T052101                        |
|   | union screw thread M10x1 for pipe ø 4mm Qty 1 pcs                          |                 |  |
|  | <b>GEV No.</b>   | 101280          | <b>Ref. No.</b> —  |
|   | olive for pipe ø 4mm Qty 1 pcs   |                 |  |

**PRO-GAS**

**100 series**

**pilot burners**











|   |   |                 |                                     |
|---|---|-----------------|-------------------------------------|
|   |   |                 |                                     |
| <b>GEV No.</b>  | 100124  | <b>Ref. No.</b> | 12001371<br>R202100                 |
| <b>description</b>  | pilot burner PRO-GAS type 100 series 3 flames nozzle ø 0.25mm   |                 |                                     |
| <b>For models:</b>  | BMG7-10, BMG9-05, BMG9-05V-T, BMG9-10, BMG9-10V-T, CG7-10, CG7-11, FTGC6-05L, FTGC6-10L, FTGC6-10L+R, MG7-10, MG7-10BM, MG9-10, MG9-10BM, MG9-10BMS, MG9-10S, MG9-15, MG9-15BM, MG9-15BM316, MG9-15BMS, MG9-15S, MG9-20, MG9-20S, MPG9-10, MPG9-10BM, MPG9-10BMS, MPG9-10S, MPG9-15, MPG9-15BM, MPG9-15BMS, MPG9-15S, MPG9-20, MPG9-20S |                 |                                     |
| <b>spare parts for</b>  | 100124  |                 |                                     |
|  | <b>GEV No.</b>  | 100764          | <b>Ref. No.</b> —                   |
|   | pilot burner bracket with angle   |                 |                                     |
|  | <b>GEV No.</b>  | 100843          | <b>Ref. No.</b> —                   |
|   | pilot burner cap 3 flames Qty 1 pcs   |                 |                                     |
|  | <b>GEV No.</b>  | 100885          | <b>Ref. No.</b> 12008510<br>X012122 |
|   | air mixing sleeve for pilot burner Qty 1 pcs  |                 |                                     |
|  | <b>GEV No.</b>  | 100916          | <b>Ref. No.</b> —                   |
|   | compression spring for pilot burner Qty 1 pcs   |                 |                                     |
|  | <b>GEV No.</b>  | 100917          | <b>Ref. No.</b> —                   |
|   | gasket for pilot burner Qty 1 pcs aluminium   |                 |                                     |
|  | <b>GEV No.</b>  | 100918          | <b>Ref. No.</b> —                   |
|   | screw for pilot burner  |                 |                                     |
|  | <b>GEV No.</b>  | 102742          | <b>Ref. No.</b> —                   |
|   | pilot burner nozzle LPG code 25 bore ø 0.25mm Qty 1 pcs   |                 |                                     |
| <b>accessories for</b>  | 100124  |                 |                                     |
|  | <b>GEV No.</b>  | 100245          | <b>Ref. No.</b> 12021187<br>U442138 |
|   | pilot burner nozzle LPG code 20 bore ø 0.2mm Qty 1 pcs thread M8x0.75   |                 |                                     |
|  | <b>GEV No.</b>  | 100246          | <b>Ref. No.</b> —                   |
|   | pilot burner nozzle natural gas bore ø 0.35mm Qty 1 pcs thread M8x0.75  |                 |                                     |

Table continues overleaf

1 gas components



1 gas components

Зип-Общепит

vsezip.ru

+7(812)987-08-81

| accessories for   |          | 100124              |          |          |
|---|----------|---------------------|----------|----------|
| GEV No.   | Ref. No. | Ref. No.            | Ref. No. | Ref. No. |
|   | 100882   | —                   | —        | —        |
| pilot burner bottom part PRO-GAS 100 series nozzle ø 0.25mm |          |                     |          |          |
|   | 100883   | —                   | —        | —        |
| pilot burner bottom part PRO-GAS 100 series nozzle ø 0.35mm |          |                     |          |          |
|   | 100904   | 12008755            | —        | —        |
| locking screw M10x1 for pipe ø 4mm Qty 1 pcs                |          |                     |          |          |
|   | 100905   | 12008715<br>U134323 | —        | —        |
| locking screw M10x1 for pipe ø 6mm Qty 1 pcs                |          |                     |          |          |
|   | 102110   | 12019428            | —        | —        |
| pilot tube copper pipe ø 4mm thickness 1mm L 3000mm         |          |                     |          |          |
|   | 102111   | —                   | —        | —        |
| pilot tube copper pipe ø 6mm thickness 1mm L 3000mm         |          |                     |          |          |

| accessories for   |          | 100139              |          |          |
|---|----------|---------------------|----------|----------|
| GEV No.   | Ref. No. | Ref. No.            | Ref. No. | Ref. No. |
|   | 100246   | —                   | —        | —        |
| pilot burner nozzle natural gas bore ø 0.35mm Qty 1 pcs thread M 8x0.75 |          |                     |          |          |
|   | 100881   | —                   | —        | —        |
| pilot burner bottom part PRO-GAS 100 series nozzle ø 0.2mm              |          |                     |          |          |
|   | 100883   | —                   | —        | —        |
| pilot burner bottom part PRO-GAS 100 series nozzle ø 0.35mm             |          |                     |          |          |
|   | 100904   | 12008755            | —        | —        |
| locking screw M10x1 for pipe ø 4mm Qty 1 pcs                            |          |                     |          |          |
|   | 100905   | 12008715<br>U134323 | —        | —        |
| locking screw M10x1 for pipe ø 6mm Qty 1 pcs                            |          |                     |          |          |
|   | 102110   | 12019428            | —        | —        |
| pilot tube copper pipe ø 4mm thickness 1mm L 3000mm                     |          |                     |          |          |
|   | 102111   | —                   | —        | —        |
| pilot tube copper pipe ø 6mm thickness 1mm L 3000mm                     |          |                     |          |          |



1

| GEV No.  | Ref. No.            | Ref. No.            | Ref. No. | Ref. No. |
|--|---------------------|---------------------|----------|----------|
| 100139   | 12005122<br>U192104 | —                   | —        | —        |
| <b>description</b> pilot burner type 100 series 3 flames nozzle ø 0.25mm nozzle A  |                     |                     |          |          |
| <b>For models:</b> CG-7115, CG9-10, CG9-10AD, CG9-10PLUS, CG9-11, CG-9110, CG9-11AD, CG9-11PLUS, CGE9-11, CGF9-120D, CGF9-120D-AD, CGF9-120I, CGF9-120I-AD, CGF9-120PLUS-D, CGF9-120PLUS-I, CGF9-121D, CGF9-121D-AD, CGF9-121I, CGF9-121I-AD, CGF9-121PLUS-D, CGF9-121PLUS-I, MG-9100, MG-9150, MG-9150BM, MG-9200, MPG-9150, MPG-9200 |                     |                     |          |          |
| <b>spare parts for</b> 100139  |                     |                     |          |          |
|  | 100843              | —                   | —        | —        |
| pilot burner cap 3 flames Qty 1 pcs  |                     |                     |          |          |
|  | 100882              | —                   | —        | —        |
| pilot burner bottom part PRO-GAS 100 series nozzle ø 0.25mm  |                     |                     |          |          |
|  | 100885              | 12008510<br>X012122 | —        | —        |
| air mixing sleeve for pilot burner Qty 1 pcs   |                     |                     |          |          |
|  | 100916              | —                   | —        | —        |
| compression spring for pilot burner Qty 1 pcs  |                     |                     |          |          |
|  | 100917              | —                   | —        | —        |
| gasket for pilot burner Qty 1 pcs aluminium  |                     |                     |          |          |
|  | 100918              | —                   | —        | —        |
| screw for pilot burner   |                     |                     |          |          |
|  | 102742              | —                   | —        | —        |
| pilot burner nozzle LPG code 25 bore ø 0.25mm Qty 1 pcs  |                     |                     |          |          |
| <b>accessories for</b> 100139  |                     |                     |          |          |
|  | 100245              | 12021187<br>U442138 | —        | —        |
| pilot burner nozzle LPG code 20 bore ø 0.2mm Qty 1 pcs thread M8x0.75  |                     |                     |          |          |

producer-specific pilot burners

FAGOR



1

| GEV No.  | Ref. No.                           | Ref. No. | Ref. No. | Ref. No. |
|--|------------------------------------|----------|----------|----------|
| 102445   | 11U4421340<br>12003282<br>12004905 | —        | —        | —        |
| <b>description</b> pilot burner SIT type 100 series 2 flames nozzle ø 0.25mm gas connection 4mm  |                                    |          |          |          |
| <b>For models:</b> CG-1002, CG-1502, CG-2000, CG-2000-2P, CG-2002, CG-2002P, CG-2005, CG-210, CG-210G, CG-300S, CG-310, CG-310G, CG7-20, CG-7200, CG7-40, CG-7400, CG7-41, CG-7415, CG7-61, CG-7615, CG9-20, CG9-40, CG9-41, CG9-51L, CG9-51LC, CG9-51R, CG9-51RC, CG9-60, CG9-61, CG9-82, CGB7-61, CGE7-100, CGE7-41, CGE9-41, CGF9-120D, CGF9-120I, CGF9-121D, CGF9-121I |                                    |          |          |          |



accessories universal

pilot burner brackets



1

|                    |  |                 |                        |
|--------------------|--|-----------------|------------------------|
| <b>GEV No.</b>     | 107847   | <b>Ref. No.</b> | 12002953<br>U445441000 |
| <b>description</b> | pilot burner bracket chrome-plated steel suitable for FAGOR H 85mm |                 |                        |
| <b>For models:</b> | CG-200S, CG-210, CG-210G, CG-300S, CG-310, CG-310G                 |                 |                        |

electrodes



1

|                    |  |                 |                       |
|--------------------|--|-----------------|-----------------------|
| <b>GEV No.</b>     | 106829   | <b>Ref. No.</b> | 12037099<br>RT7400290 |
| <b>description</b> | gasket for ignition electrode ID $\varnothing$ 10mm hole $\varnothing$ 4.5mm L 27mm W 17mm |                 |                       |



1

|                    |  |                 |                     |
|--------------------|--|-----------------|---------------------|
| <b>GEV No.</b>     | 109065   | <b>Ref. No.</b> | 12018030<br>R725079 |
| <b>description</b> | gasket hole $\varnothing$ 10mm L 27mm W 17mm   |                 |                     |
| <b>For models:</b> | HCG-10-11, HCG-10-21, HCG-20-11, HCG-20-21, HCG-2-10-11, HCG-6-11, HMG-10-11, HMG-10-11UL, HMG-10-21, HMG-10-21UL, HMG-20-11, HMG-2-10-11, HMG-6-11, HVG-10-11, HVG-10-21, HVG-20-11, HVG-20-21, HVG-2-10-11 |                 |                     |



1

|                    |   |                 |                       |
|--------------------|---|-----------------|-----------------------|
| <b>GEV No.</b>     | 550897  | <b>Ref. No.</b> | 12036535<br>RT4400250 |
| <b>description</b> | gasket ignition electrode graphite thickness 2.5mm hole distance 27mm |                 |                       |

Зип Общепит

vsezip.ru

+7(812)987-08-81

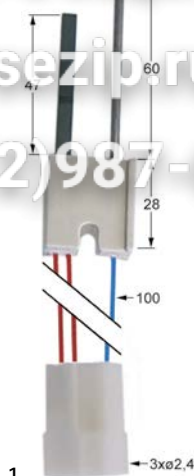

1

|                    |   |                 |          |
|--------------------|---|-----------------|----------|
| <b>GEV No.</b>     | 100730  | <b>Ref. No.</b> | 12027683 |
| <b>description</b> | glow plug cable length 100mm connection $\varnothing$ 2.4mm L1 47mm L2 60mm |                 |          |

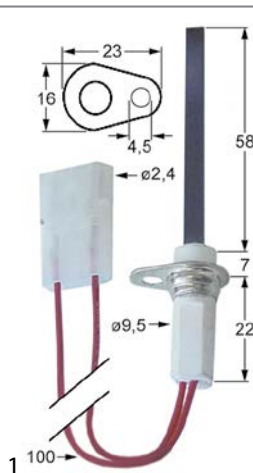

1

|                    |   |                 |                     |
|--------------------|---|-----------------|---------------------|
| <b>GEV No.</b>     | 100757  | <b>Ref. No.</b> | 12017356<br>R723005 |
| <b>description</b> | glow plug flange length 23mm flange width 16mm $\varnothing$ 9.5mm cable length 100mm connection $\varnothing$ 2.4mm total length 220mm L1 58mm fixing dimensions 4.5mm |                 |                     |
| <b>For models:</b> | HCG-10-11, HCG-10-21, HCG-20-11, HCG-2-10-11, HCG-6-11, HMG-10-11, HMG-10-11UL, HMG-10-21, HMG-10-21UL, HMG-20-11, HMG-2-10-11, HMG-6-11                                |                 |                     |

Зип Общепит

vsezip.ru

+7(812)987-08-81



|                    |  |                 |                        |
|--------------------|--|-----------------|------------------------|
| <b>GEV No.</b>     | 107848   | <b>Ref. No.</b> | 12009060<br>X022131000 |
| <b>description</b> | ignition electrode D1 ø 7mm D2 ø 8mm L1 2mm L2 8mm BL1 23mm BL2 3mm BL3 18mm   |                 |                        |
| <b>For models:</b> | BG6-05I, BG7-05, BG7-05I, BG7-10, BG7-10I, BG9-05AD, BG9-05PF, BG9-05PI, BG9-05PLUS-I, BG9-10AD, BG9-10PF, BG9-10PI, BG9-10PLUS-I, BMG9-05, BMG9-05V-T, BMG9-10, BMG9-10V-T, CG-1002, CG-1502, CG-2002, CG-2002P, CG6-41, CG9-10, CG9-10AD, CG9-10PLUS, CG9-11, CG9-11AD, CG9-11PLUS, CG9-31PLUS-D, CG9-31PLUS-I, CG9-41, CG9-41AD, CG9-41AD-H, CG9-41H, CG9-41PLUS, CG9-41PLUS-H, CG9-51L, CG9-51LC, CG9-51R, CG9-51RC, CG9-61, CG9-61AD, CG9-61AD-H, CG9-61H, CG9-61OP, CG9-61PLUS, CG9-61PLUS-H, CG9-82, CG9-82AD, CG9-82PLUS...(Other models you can see in the webshop) |                 |                        |

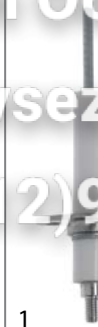

|                    |   |                 |                        |
|--------------------|---|-----------------|------------------------|
| <b>GEV No.</b>     | 104806  | <b>Ref. No.</b> | 12039586<br>T855753000 |
| <b>description</b> | ignition electrode flange length 23mm flange width 1 16mm D1 ø 9.4mm D2 ø 9.4mm L1 25mm BL1 17mm BL2 36mm |                 |                        |
| <b>For models:</b> | AG-061, AG-061W, AG-101, AG-101W, APG-061, APG-061W, APG-101, APG-101W                                    |                 |                        |

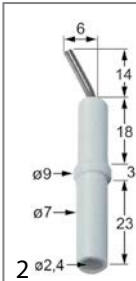

|                    |  |                 |                     |
|--------------------|--|-----------------|---------------------|
| <b>GEV No.</b>     | 100707   | <b>Ref. No.</b> | 12008994<br>X012101 |
| <b>description</b> | ignition electrode D1 ø 7mm D2 ø 9mm connection ø2.4mm L1 14mm L2 6mm BL1 18mm BL2 3mm BL3 23mm to clip Qty 1 pcs  |                 |                     |
| <b>For models:</b> | BG7-05, BG7-05I, BG7-10, BG7-10I, BG9-05, BG9-05I, BG9-10, BG9-10I, BMG-9045, BMG9-05, BMG9-10, CG-1002, CG-110, CG-1502, CG-2000, CG-2000-2P, CG-2002, CG-7115, CG-7415, CG-7615, CG9-05AD, CG9-05PLUS, CG9-10, CG9-11, CG-9110, CG9-20AD, CG9-20AD-H, CG9-20PLUS, CG9-20PLUS-H, CG9-31PLUS-D, CG9-31PLUS-I, CG9-40AD, CG9-40AD-H, CG9-40PLUS, CG9-40PLUS-H, CG9-41, CG9-41AD, CG9-41AD-H, CG9-41PLUS, CG9-41PLUS-H, CG9-51L, CG9-51LC, CG9-51R, CG9-51RC, CG9-60AD, CG9-60AD-H, CG9-60PLUS, CG9-60PLUS-H, CG9-61, CG9-61AD...(Other models you can see in the webshop) |                 |                     |



|                    |  |                 |                        |
|--------------------|--|-----------------|------------------------|
| <b>GEV No.</b>     | 104803   | <b>Ref. No.</b> | 12039448<br>T645746000 |
| <b>description</b> | ignition electrode flange length 23mm flange width 1 16mm D1 ø 9.5mm D2 ø 9.5mm L1 10mm L2 79mm BL1 72.5mm BL2 24mm flange |                 |                        |
| <b>For models:</b> | ACG-102, ACG-202, AG-102, AG-102W, AG-202, APG-102, APG-102W, APG-202  |                 |                        |

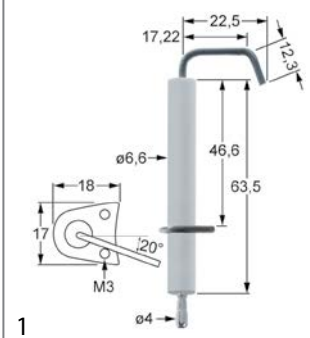

|                    |  |                 |                        |
|--------------------|--|-----------------|------------------------|
| <b>GEV No.</b>     | 107858   | <b>Ref. No.</b> | 12033209<br>RT20680300 |
| <b>description</b> | ignition electrode flange length 18mm flange width 17mm D1 ø 7mm D2 ø 7.5mm L1 5.5mm L2 23mm L3 14mm BL1 46.5mm BL2 13.5mm mounting distance 10mm connection ø 4mm |                 |                        |





Зип Общежит

vsezip.ru

+7(812)987-08-81

|                    |  |                 |                     |
|--------------------|--|-----------------|---------------------|
| <b>GEV No.</b>     | 102448   | <b>Ref. No.</b> | 12018798<br>T115711 |
| <b>description</b> | ignition electrode flange length 23mm flange width 16mm D1 ø 9.5mm L1 63mm L2 18mm L3 28mm BL1 80mm BL2 32mm fixing dimensions 4.5mm flange connection ø 6mm |                 |                     |
| <b>For models:</b> | HCG-10-11, HCG-10-21, HCG-2-10-11, HVG-10-11, HVG-10-21, HVG-2-10-11   |                 |                     |

|                    |  |                 |                     |
|--------------------|--|-----------------|---------------------|
| <b>GEV No.</b>     | 102446   | <b>Ref. No.</b> | 12025163<br>Z955803 |
| <b>description</b> | ignition electrode flange length 23mm flange width 15mm D1 ø 7.5mm L1 13mm L2 9mm BL1 14mm BL2 21mm connection F2.8x0.8  |                 |                     |
| <b>For models:</b> | GA-20, GA-20D, GA-40, GA-40D, HGP-10-21, HGP-20-21, HGV-10-11, HGV-10-21, HGV-20-11, HGV-20-21, HVG-10-11, HVG-10-11UL, HVG-10-21, HVG-10-21UL, HVG-20-11, HVG-20-21, HVG-2-10-11, HVG-2-20-21, MFHVG-10-11, MFHVG-10-21, VG-101, VG-102, VG-201, VG-202, VPG-101, VPG-102, VPG-201, VPG-202 |                 |                     |

|                    |  |                 |                        |
|--------------------|--|-----------------|------------------------|
| <b>GEV No.</b>     | 104804   | <b>Ref. No.</b> | 12039685<br>T955755000 |
| <b>description</b> | ignition electrode flange length 23mm flange width 16mm D1 ø 9mm D2 ø 9mm L1 17mm L2 79mm BL1 80mm BL2 17mm connection M4 flange |                 |                        |
| <b>For models:</b> | ACG-061, ACG-101, ACG-201, AG-061, AG-061W, AG-101, AG-101W, AG-201, APG-061, APG-061W, APG-101, APG-101W, APG-201               |                 |                        |

|   |  |                 |   |                     |
|---|--|-----------------|---|---------------------|
| <b>GEV No.</b>  | 100759   | <b>Ref. No.</b> | 12000118<br>12023896<br>12040020<br>R725014<br>T115059<br>T135705 |                     |
| <b>description</b>  | ignition electrode flange length 24mm flange width 17mm D1 ø 5mm D2 ø 9.5mm L1 54mm BL1 24mm BL2 24mm fixing dimensions ø4.5mm with flange connection ø 4mm A1/B13/C2  |                 |   |                     |
| <b>For models:</b>  | COG-201, COG-202, HCG-10-11, HCG-10-21, HCG-20-11, HCG-20-21, HCG-2-10-11, HCG-2-20-11, HCG-6-11, HGC-20-11, HGC-20-21, HGP-20-21, HGV-20-11, HGV-20-21, HMG-10-11, HMG-10-11UL, HMG-10-21, HMG-10-21UL, HMG-20-11, HMG-2-10-11, HMG-6-11, HVG-20-11, HVG-20-21, HVG-2-20-21, VG-201, VG-202, VPG-201, VPG-202 |                 |   |                     |
| <b>accessories for</b>  | 100759   |                 |   |                     |
|  | <b>GEV No.</b>   | 109065          | <b>Ref. No.</b>   | 12018030<br>R725079 |
|   | gasket hole ø 10mm L 27mm W 17mm   |                 |   |                     |



Зип Общепит

vsezip.ru

+7(812)987-08-81



|                    |  |                 |                       |
|--------------------|--|-----------------|-----------------------|
| <b>GEV No.</b>     | 103302   | <b>Ref. No.</b> | 12038022<br>RT7400230 |
| <b>description</b> | ignition electrode flange length 26mm flange width 16mm D1 ø 9mm L1 9mm L2 73mm BL1 82mm BL2 14mm connection F 4.8x0.8mm cable length 400mm mounting distance 19mm with flange |                 |                       |

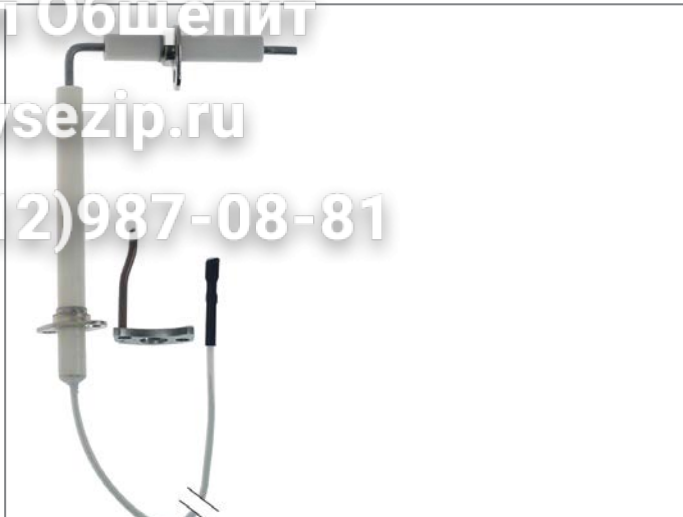

|                    |  |                 |                        |
|--------------------|--|-----------------|------------------------|
| <b>GEV No.</b>     | 104805   | <b>Ref. No.</b> | 12039684<br>T955754000 |
| <b>description</b> | ignition electrode flange length 28mm flange width 16mm D1 ø 9mm D2 ø 9mm L1 16.5mm L2 80mm BL1 81mm BL2 16.5mm connection F2.8 cable length 250mm mounting distance 20mm flange |                 |                        |
| <b>For models:</b> | ACG-061, ACG-101, ACG-201, AG-061, AG-061W, AG-101, AG-101W, AG-201, APG-061, APG-061W, APG-101, APG-101W, APG-201   |                 |                        |



|                    |   |                 |          |
|--------------------|---|-----------------|----------|
| <b>GEV No.</b>     | 104802  | <b>Ref. No.</b> | 12039447 |
| <b>description</b> | ignition electrode flange length 28mm flange width 16mm D1 ø 9.4mm D2 ø 9.4mm L1 9mm L2 73mm BL1 72.5mm BL2 26mm connection F2.8 cable length 260mm mounting distance 20mm flange |                 |          |
| <b>For models:</b> | ACG-102, ACG-202, AG-102, AG-102W, AG-202, APG-102, APG-102W, APG-202   |                 |          |

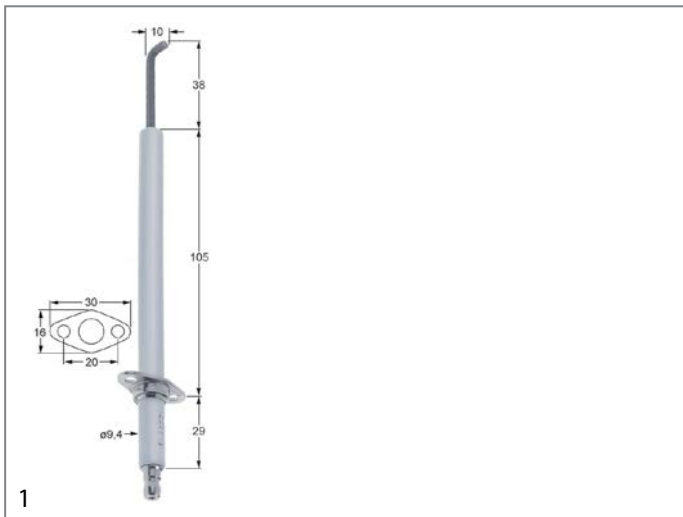

|                    |  |                 |          |
|--------------------|--|-----------------|----------|
| <b>GEV No.</b>     | 109111   | <b>Ref. No.</b> | 12024726 |
| <b>description</b> | ignition electrode flange length 30mm flange width 16mm D1 ø 9.4mm L1 38mm L2 10mm BL1 105mm BL2 29mm mounting distance 20mm flange connection |                 |          |
| <b>For models:</b> | COG-201, COG-202, HGC-20-11, HGC-20-21, HGP-20-21, HGV-20-11, HGV-20-21, VG-201, VG-202, VPG-201, VPG-202                                      |                 |          |



Зип Общепит

vsezip.ru

+7(812)987-08-81

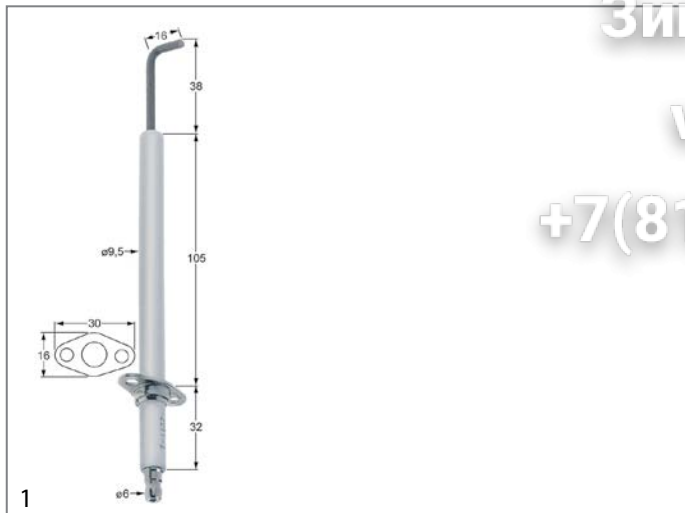

|                    |   |                 |                     |
|--------------------|---|-----------------|---------------------|
| <b>GEV No.</b>     | 102765  | <b>Ref. No.</b> | 12024719<br>T115781 |
| <b>description</b> | ignition electrode flange length 30mm flange width 16mm D1 9.5mm L1 38mm L2 16mm BL1 105mm BL2 32mm connection 6mm  |                 |                     |
| <b>For models:</b> | COG-101, COG-102, HCG-10-11, HCG-10-21, HCG-2-10-11, HGC-10-11, HGC-10-21, HGP-10-21, HGV-10-11, HGV-10-21, HVG-10-11, HVG-10-11UL, HVG-10-21, HVG-10-21UL, HVG-2-10-11, MFHVG-10-11, MFHVG-10-21, VG-101, VG-102, VPG-101, VPG-102 |                 |                     |

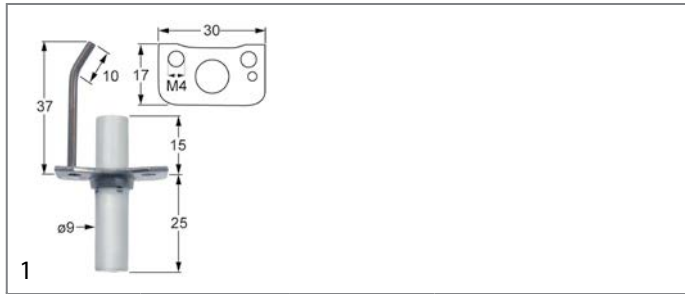

|                    |   |                 |                       |
|--------------------|---|-----------------|-----------------------|
| <b>GEV No.</b>     | 103333  | <b>Ref. No.</b> | 12037972<br>RT7400235 |
| <b>description</b> | ignition electrode flange length 30mm flange width 17mm D1 9mm L1 37mm L2 10mm BL1 15mm BL2 25mm fixing dimensions M4mm with flange with earthing contact |                 |                       |



|                    |  |                 |                        |
|--------------------|--|-----------------|------------------------|
| <b>GEV No.</b>     | 104807   | <b>Ref. No.</b> | 12039585<br>T855752000 |
| <b>description</b> | ignition electrode flange length 38mm flange width 16mm D1 9.4mm D2 9.4mm L1 25mm BL1 17mm BL2 36mm connection F2.8 cable length 250mm fixing dimensions 4mm mounting distance 28mm flange |                 |                        |
| <b>For models:</b> | AG-061, AG-061W, AG-101, AG-101W, APG-061, APG-061W, APG-101, APG-101W   |                 |                        |

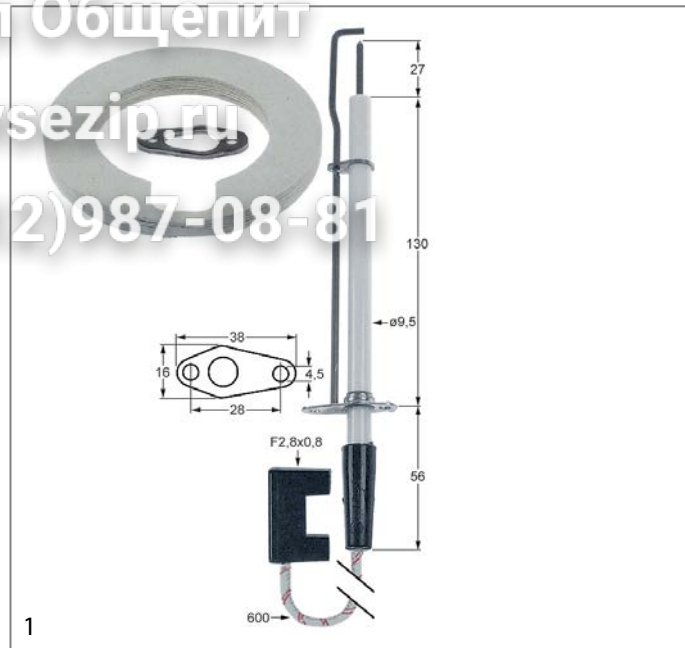

|                    |  |                 |                                    |
|--------------------|--|-----------------|------------------------------------|
| <b>GEV No.</b>     | 102884   | <b>Ref. No.</b> | 12028814<br>87.00.662<br>RT4400249 |
| <b>description</b> | ignition electrode flange length 38mm flange width 16mm D1 9.5mm L1 27mm BL1 130mm BL2 56mm connection F 2.8x0.8mm cable length 600mm fixing dimensions 4.5mm mounting distance 28mm with flange with earthing contact |                 |                                    |



|                    |   |                 |                        |
|--------------------|---|-----------------|------------------------|
| <b>GEV No.</b>     | 107849  | <b>Ref. No.</b> | 12025155<br>Z955802000 |
| <b>description</b> | ignition electrode flange length 66mm flange width 24mm D1 7mm D2 2mm L1 11mm L2 10mm BL1 15mm BL2 6mm BL3 15mm connection 2.8                          |                 |                        |
| <b>For models:</b> | GA-20, GA-20D, GA-40, GA-40D, HGP-10-21, HGP-20-21, HGV-10-11, HGV-20-11, HGV-20-21, VG-101, VG-102, VG-201, VG-202, VPG-101, VPG-102, VPG-201, VPG-202 |                 |                        |

Зип Общепит

vsezip.ru

+7(812)987-08-81

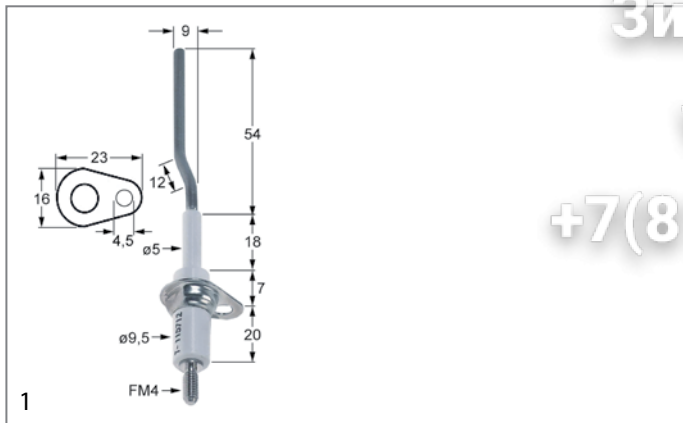

|                    |  |                 |                     |
|--------------------|--|-----------------|---------------------|
| <b>GEV No.</b>     | 102447   | <b>Ref. No.</b> | 12023920<br>T115712 |
| <b>description</b> | monitoring electrode flange length 23mm D1 ø 5mm flange width 16mm D2 ø 9.5mm L1 54mm L2 9mm L3 12mm BL1 18mm BL2 7mm BL3 20mm connection M4 fixing dimensions 4.5mm   |                 |                     |
| <b>For models:</b> | COG-061, COG-101, COG-102, HCG-10-11, HCG-10-21, HCG-2-10-11, HCG-6-11, HGC-10-11, HGC-10-21, HGC-6-11, HGP-10-21, HGV-10-11, HGV-10-21, HVG-10-11, HVG-10-11UL, HVG-10-21, HVG-10-21UL, HVG-2-10-11, MFHVG-10-11, MFHVG-10-21, VG-101, VG-102, VPG-101, VPG-102 |                 |                     |

### ignition cables

#### pre-assembled cables

|                    |   |                 |                      |
|--------------------|---|-----------------|----------------------|
| <b>GEV No.</b>     | 100175  | <b>Ref. No.</b> | 12037970<br>ICR08053 |
| <b>description</b> | ignition cable cable length 1750mm connection ø2.4mm / ø4mm |                 |                      |

|                    |   |                 |                     |
|--------------------|---|-----------------|---------------------|
| <b>GEV No.</b>     | 102162  | <b>Ref. No.</b> | 12023555<br>U333003 |
| <b>description</b> | ignition cable cable length 400mm connection F2.8mm / F6.3mm  |                 |                     |
| <b>For models:</b> | BG6-05I, BG7-05, BG7-05I, BG7-10, BG7-10I, BG9-05, BG9-05I, BG9-05PF, BG9-05PI, BG9-10, BG9-10I, BG9-10PF, BG9-10PI, BMG9-05, BMG9-05V-T, BMG9-10, BMG9-10V-T, CG-1002, CG-1502, CG-2000, CG-2000-2P, CG-2002, CG-2002P, CG6-20, CG6-40, CG6-41, CG9-05AD, CG9-05PLUS, CG9-10, CG9-10AD, CG9-10PLUS, CG9-11, CG9-11AD, CG9-11PLUS, CG9-20AD, CG9-20AD-H, CG9-20PLUS, CG9-20PLUS-H, CG9-40AD, CG9-40AD-H, CG9-40PLUS, CG9-40PLUS-H, CG9-41, CG9-41AD, CG9-41AD-H, CG9-41H, CG9-41PLUS, CG9-41PLUS-H, CG9-51L, CG9-51LC...(Other models you can see in the webshop) |                 |                     |

|                    |  |                 |                     |
|--------------------|--|-----------------|---------------------|
| <b>GEV No.</b>     | 100016   | <b>Ref. No.</b> | 12039113<br>R613030 |
| <b>description</b> | ignition cable cable length 900mm connection ø2.4mm / ø2.4mm |                 |                     |

|                    |   |                 |   |
|--------------------|---|-----------------|---|
| <b>GEV No.</b>     | 106265  | <b>Ref. No.</b> | 12012207<br>12024305<br>12040087<br>U323003<br>U323030<br>X012118 |
| <b>description</b> | ignition cable cable length 985mm connection ø2.4mm   |                 |   |
| <b>For models:</b> | CG-1002, CG-1502, CG-2000, CG-2000-2P, CG-2002, CG-2002P, CG9-10, CG9-11, CG9-41, CG9-41H, CG9-51L, CG9-51LC, CG9-51R, CG9-51RC, CG9-61, CG9-61H, CG9-61OP, CG9-82, CGB7-61, CGE9-11, CGE9-41, CGF9-120D, CGF9-120I, CGF9-121D, CGF9-121I, CGP9-11, CPG9-05, CPG9-05NC, CPG9-05S, CPG9-05SNC, FG-71-15, FG-72-30, FG-91-20, FG-92-40, FTG7-05L, FTG7-05R, FTG7-05VL, FTG7-05VR, FTG7-10L, FTG7-10L+R, FTG7-10R, FTG7-10VL, FTG7-10VL+R, FTG7-10VR, FTG9-11L, FTG9-11L+R, FTG9-11R, FTGC7-05L, FTGC7-10L, FTGC9-11L... (Other models you can see in the webshop) |                 |   |

### piezoelectric igniters

#### mounting diameter 18mm

|                    |  |                 |          |
|--------------------|--|-----------------|----------|
| <b>GEV No.</b>     | 102877   | <b>Ref. No.</b> | ICR10041 |
| <b>description</b> | piezoelectric igniter body plastic blowing mounting ø 18mm connection F2.8x0.8 |                 |          |

|                        |  |                 |                      |
|------------------------|--|-----------------|----------------------|
| <b>GEV No.</b>         | 100009   | <b>Ref. No.</b> | 12033471<br>ICR16132 |
| <b>description</b>     | piezoelectric igniter body plastic blowing mounting ø 18mm connection ø2.4mm front measurements 26mm M18x1.5 |                 |                      |
| <b>accessories for</b> | 100009   |                 |                      |
| <b>GEV No.</b>         | 101339   | <b>Ref. No.</b> | —                    |
| <b>description</b>     | cover cap for piezoelectric igniter  |                 |                      |
| <b>GEV No.</b>         | 106869   | <b>Ref. No.</b> | —                    |
| <b>description</b>     | cover cap for piezoelectric igniter ID ø 22mm ED ø 35mm H 25mm   |                 |                      |
| <b>GEV No.</b>         | 107931   | <b>Ref. No.</b> | —                    |
| <b>description</b>     | cover cap for piezoelectric igniter ID ø 21mm ED ø 36mm  |                 |                      |



Зип Общежит  
thermocouples

vsezip.ru

+7(812)987-08-81

mounting diameter 22mm



|                    |   |                 |                     |
|--------------------|---|-----------------|---------------------|
| <b>GEV No.</b>     | 100005  | <b>Ref. No.</b> | 12024807<br>S113034 |
| <b>description</b> | piezoelectric igniter body plastic blowing mounting $\varnothing$ 22mm connection $\varnothing$ 2.4mm cable lengthmm SIT  |                 |                     |
| <b>For models:</b> | BG6-05I, BG7-05, BG7-05I, BG7-10, BG7-10I, BG9-05, BG9-05I, BG9-05PF, BG9-05PI, BG9-10, BG9-10I, BG9-10PF, BG9-10PI, BMG9-05, BMG9-05V-T, BMG9-10, BMG9-10V-T, CG-1002, CG-1502, CG-2000, CG-2000-2P, CG-2002, CG-2002P, CG6-20, CG6-40, CG6-41, CG9-10, CG9-11, CG9-40H, CG9-41, CG9-41H, CG9-51L, CG9-51LC, CG9-51R, CG9-51RC, CG9-61, CG9-61H, CG9-61OP, CG9-82, CGB7-61, CGB7-61H, CGB7-61R, CGB7-61RH, CGE6-41, CGE9-11, CGF9-120D, CGF9-120I, CGF9-121D, CGF9-121I, CGP9-11...(Other models you can see in the webshop) |                 |                     |

miscellaneous



|                    |   |                 |            |
|--------------------|---|-----------------|------------|
| <b>GEV No.</b>     | 100006  | <b>Ref. No.</b> | T982001000 |
| <b>description</b> | piezoelectric igniter suitable for ELETROSIT body plastic blowing connection $\varnothing$ 2.4mm $\varnothing$ 14mm |                 |            |

ignition units



|                    |   |                 |  |
|--------------------|---|-----------------|--|
| <b>GEV No.</b>     | 101012  | <b>Ref. No.</b> | 12020231<br>12024347<br>R073007<br>X163014 |
| <b>description</b> | ignition unit outputs 2 230VAC dimensions 48x32x32mm mounting distance 56mm inlet F2.8x0.8 outlet F2.8x0.8 type ZIG2 50-60Hz  |                 |  |
| <b>For models:</b> | BG9-05AD, BG9-05PLUS-I, BG9-10AD, BG9-10PLUS-I, CG-7200, CG-7415, CG9-05AD, CG9-05PLUS, CG9-10AD, CG9-10PLUS, CG9-11AD, CG9-11PLUS, CG9-20AD, CG9-20AD-H, CG9-20PLUS, CG9-20PLUS-H, CG9-31PLUS-D, CG9-31PLUS-I, CG9-41AD, CG9-41AD-H, CG9-41PLUS, CG9-41PLUS-H, CG9-61AD, CG9-61AD-H, CG9-61PLUS, CG9-61PLUS-H, CG9-82AD, CG9-82PLUS, CGF9-121D-AD, CGF9-121PLUS-D, CGF9-121PLUS-I, CPG9-05AD, CPG9-05AD-S, CPG9-05PLUS, CPG9-05PLUS-S, FG7-05-1C, FG7-05-2C, FG-710, FG7-10-2C, FG7-104C, FG7-10-4C, FG-720, FG9-05, FG9-05-1C, FG9-05-2C, FG9-05AD, FG9-05PLUS, FG9-05PLUS-S, FG9-05S, FG9-05S-1C...(Other models you can see in the webshop) |                 |  |

plug-in thermocouples

plug-in thermocouples standard

with barrel socket  $\varnothing$ 6(6.5)mm

thermocouples SIT

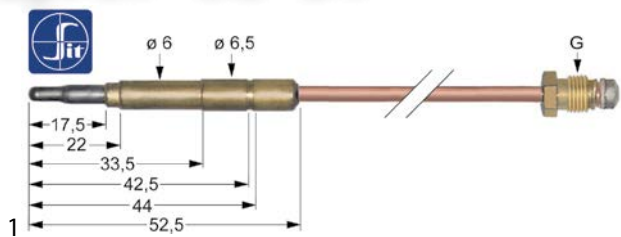

|                    |  |                 |                      |
|--------------------|--|-----------------|----------------------|
| <b>GEV No.</b>     | 107621   | <b>Ref. No.</b> | 12037971<br>ICR10070 |
| <b>description</b> | thermocouple SIT M10x1 L 1500mm plug connection $\varnothing$ 6.0(6.5)mm |                 |                      |

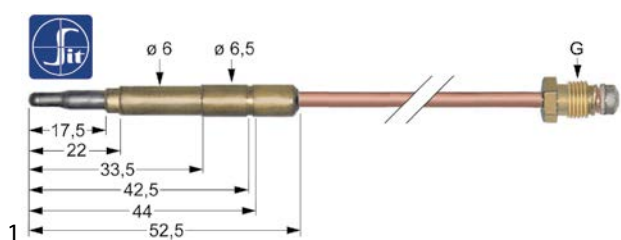

|                    |   |                 |  |
|--------------------|---|-----------------|--|
| <b>GEV No.</b>     | 107605  | <b>Ref. No.</b> | 12020122<br>12020138<br>U322101<br>U322130 |
| <b>description</b> | thermocouple SIT M8x1 L 1500mm plug connection $\varnothing$ 6.0(6.5)mm |                 |  |
| <b>For models:</b> | CG7-11, CG7-41, CG-7415, CG7-61, CG-7615, CGB7-61, CGP9-11              |                 |  |

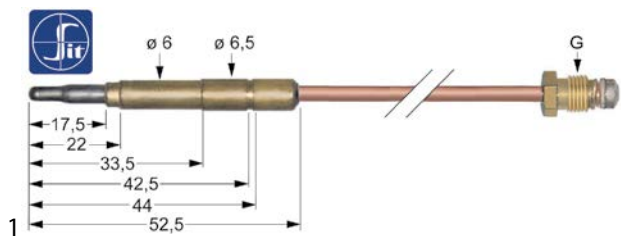

|                    |   |                 |                     |
|--------------------|---|-----------------|---------------------|
| <b>GEV No.</b>     | 107601  | <b>Ref. No.</b> | 12020688<br>U222100 |
| <b>description</b> | thermocouple SIT M8x1 L 600mm plug connection $\varnothing$ 6.0(6.5)mm  |                 |                     |
| <b>For models:</b> | BG7-05, BG7-10, BG9-05, BG9-10, BMG7-10, BMG-9045, BMG9-05, BMG9-10, CG-2000, CG-2000-2P, CG-2005, CG-210, CG-210G, CG-300S, CG-310, CG-310G, CG7-10, CG7-11, CG7-20, CG-7200, CG7-40, CG-7400, CG7-41, CG-7415, CG7-61, CG-7615, CG9-20, CG9-40, CG9-41, CG9-51L, CG9-51LC, CG9-51R, CG9-51RC, CG9-60, CG9-61, CG9-82, CGE7-134, FG-91-20, FG-92-40, FTG7-05, FTG-7050L, FTG-7050R, FTG7-10, FTG-7100L, FTG-7100L+R, FTG-7100R, FTG-9050L, FTG-9050R, FTG9-05L, FTG9-05R...(Other models you can see in the webshop) |                 |                     |

1 gas components

Зип-Общепит

vsezip.ru

+7(812)987-08-81

thermocouples (miscellaneous)

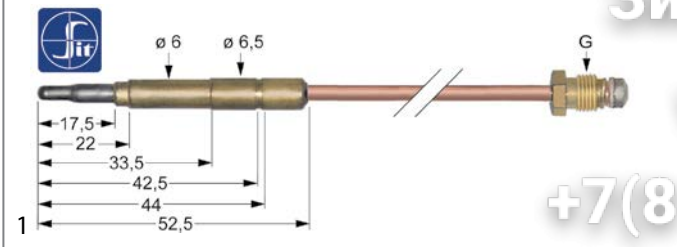

|                    |   |                 |         |
|--------------------|---|-----------------|---------|
| <b>GEV No.</b>     | 107612  | <b>Ref. No.</b> | U562120 |
| <b>description</b> | thermocouple SIT M9x1 L 1000mm plug connection $\phi 6.0(6.5)$ mm |                 |         |



|                    |  |                 |                     |
|--------------------|--|-----------------|---------------------|
| <b>GEV No.</b>     | 102462                                   | <b>Ref. No.</b> | 12008344<br>U262130 |
| <b>description</b> | thermocouple M8x1 L 1000mm barrel socket |                 |                     |

**For models:** CG-210, CG-210G, CG-310, CG-310G, CG6-41, CG9-20, CG9-20H, CG9-40, CG9-40H, CG9-41, CG9-41H, CG9-51L, CG9-51LC, CG9-51R, CG9-51RC, CG9-60, CG9-60H, CG9-61, CG9-61H, CG9-61OP, CG9-82, CGE9-41, CGF9-120D, CGF9-120I, CGF9-121D, CGF9-121I, CPG7-05, CPG7-05NC, CPG9-05, CPG9-05AD, CPG9-05AD-S, CPG9-05NC, CPG9-05PLUS, CPG9-05PLUS-S, CPG9-05S, CPG9-05SNC, GPC-350

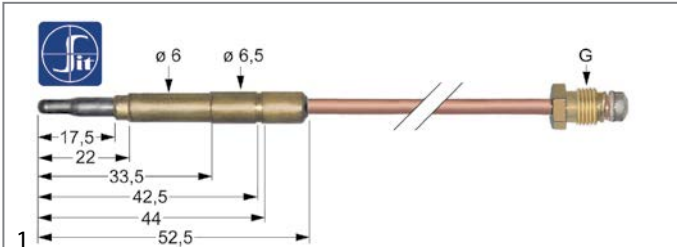

|                    |   |                 |          |
|--------------------|---|-----------------|----------|
| <b>GEV No.</b>     | 107614  | <b>Ref. No.</b> | 12009208 |
| <b>description</b> | thermocouple SIT M9x1 L 1500mm plug connection $\phi 6.0(6.5)$ mm |                 |          |

**For models:** CG7-11, CG7-31D, CG7-31I, CG7-41, CG7-41H, CG7-51, CG7-61, CG7-61H, CGB7-61, CGB7-61H, CGB7-61R, CGB7-61RH, CGP9-11

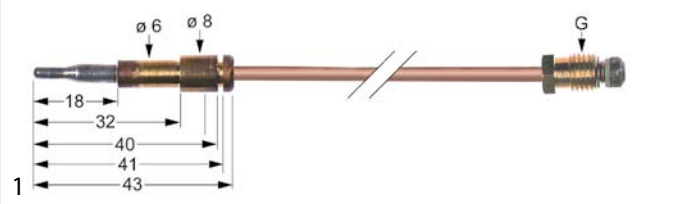

|                    |   |                 |                     |
|--------------------|---|-----------------|---------------------|
| <b>GEV No.</b>     | 102451                                  | <b>Ref. No.</b> | 12009768<br>U222130 |
| <b>description</b> | thermocouple M8x1 L 600mm barrel socket |                 |                     |

**For models:** BG6-05I, BG7-05, BG7-05I, BG7-10, BG7-10I, BG9-05, BG9-05AD, BG9-05I, BG9-05PF, BG9-05PI, BG9-05PLUS-I, BG9-10, BG9-10AD, BG9-10I, BG9-10PF, BG9-10PI, BG9-10PLUS-I, BMG7-10, BMG9-05, BMG9-05V-T, BMG9-10, BMG9-10V-T, CG-1002, CG-1502, CG-2002, CG-2002P, CG-2005, CG-210, CG-210G, CG-300S, CG-310, CG-310G, CG7-10, CG7-11, CG7-20, CG7-20H, CG7-30D, CG7-30I, CG7-31D, CG7-31I, CG7-40, CG7-40H, CG7-41, CG7-41H, CG7-50, CG7-51, CG7-60, CG7-60H, CG7-61, CG7-61H...(Other models you can see in the webshop)

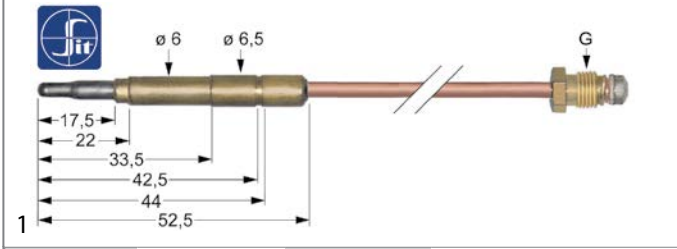

|                    |  |                 |                     |
|--------------------|--|-----------------|---------------------|
| <b>GEV No.</b>     | 107611   | <b>Ref. No.</b> | 12009182<br>U562130 |
| <b>description</b> | thermocouple SIT M9x1 L 850mm plug connection $\phi 6.0(6.5)$ mm |                 |                     |

**For models:** CG-1002, CG-1502, CG-2002, CG-2002P, CG-210, CG-210G, CG-310, CG-310G, CG9-11, CG9-11AD, CG9-11PLUS, CG9-31PLUS-D, CG9-31PLUS-I, CG9-41, CG9-41AD, CG9-41AD-H, CG9-41H, CG9-41PLUS, CG9-41PLUS-H, CG9-51L, CG9-51LC, CG9-51R, CG9-51RC, CG9-61, CG9-61AD, CG9-61AD-H, CG9-61H, CG9-61OP, CG9-61PLUS, CG9-61PLUS-H, CG9-82, CG9-82AD, CG9-82PLUS, CGF9-121D, CGF9-121D-AD, CGF9-121I, CGF9-121PLUS-D, CGF9-121PLUS-I, CPG7-05, CPG9-05, CPG9-05NC, CPG9-05S, CPG9-05SNC, FG7-05-1C, FG7-05-2C, FG-710, FG7-10-2C, FG7-104C, FG7-10-4C, FG-720...(Other models you can see in the webshop)

plug-in thermocouples with interruption

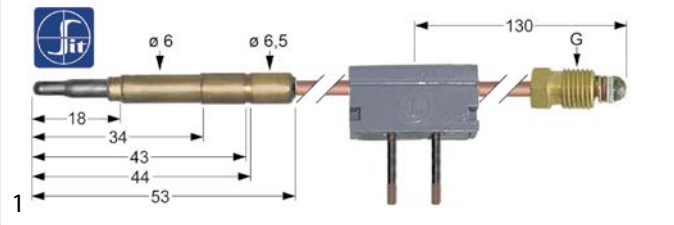

|                    |   |                 |                     |
|--------------------|---|-----------------|---------------------|
| <b>GEV No.</b>     | 107164  | <b>Ref. No.</b> | 12008273<br>S042106 |
| <b>description</b> | thermocouple SIT with interrupter M9x1 L 1000mm plug connection $\phi 6.0(6.5)$ mm soldering connection |                 |                     |

**For models:** FG6-05, FG6-10, MG7-10BM, MG9-10BM, MG9-10BMS, MG9-10S, MG9-15BM, MG9-15BM316, MG9-15BMS, MG9-15S, MG9-20S, MPG9-10BM, MPG9-10BMS, MPG9-15BM, MPG9-15BMS

thermocouples with aluminised tip

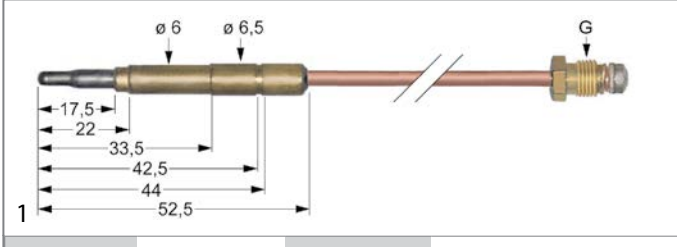

|                    |  |                 |                                |
|--------------------|--|-----------------|--------------------------------|
| <b>GEV No.</b>     | 102042   | <b>Ref. No.</b> | 12021360<br>U262120<br>X152120 |
| <b>description</b> | thermocouple M9x1 L 850mm plug connection $\phi 6.0(6.5)$ mm |                 |                                |

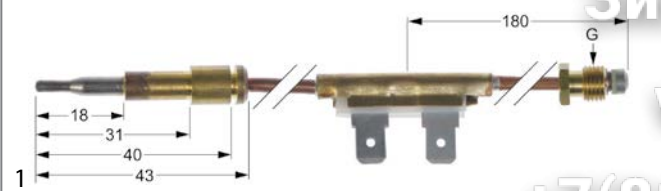
|                    |   |                 |                     |
|--------------------|---|-----------------|---------------------|
| <b>GEV No.</b>     | 102269  | <b>Ref. No.</b> | 12019001<br>X022130 |
| <b>description</b> | thermocouple with interrupter M9x1 L 850mm F 6.3mm  |                 |                     |
| <b>For models:</b> | FTGC9-05, FTGC-9050, FTGC9-10, FTGC-9100, MG7-10BM, MG9-10BM, MG9-10BMS, MG-9150BM, MG9-15BM, MG9-15BMS, MPG9-10BM, MPG9-10BMS, MPG9-15BM, MPG9-15BMS, SBG-9040 |                 |                     |

Зип-Общепит  
ignition pipes  
vsezip.ru  
+7(812)987-08-81



|                    |  |                 |                     |
|--------------------|--|-----------------|---------------------|
| <b>GEV No.</b>     | 109194   | <b>Ref. No.</b> | 12038892<br>X155035 |
| <b>description</b> | ignition pipe L 146mm ø 21.3mm for tilting bratt pan   |                 |                     |
| <b>For models:</b> | SBG7-10, SBG9-10, SBG9-10I, SBG9-10IM, SBG9-10IMS, SBG9-10IS, SBG9-10M, SBG9-10MS, SBG9-10S, SBG9-15IM, SBG9-15IMS |                 |                     |

accessories

screws



|                    |   |                 |                     |
|--------------------|---|-----------------|---------------------|
| <b>GEV No.</b>     | 102464  | <b>Ref. No.</b> | 12021477<br>R275014 |
| <b>description</b> | thermocouple fitting thread M10x1 brass Qty 1 pcs |                 |                     |
| <b>For models:</b> | HG-10-11, HG-10-21, HG-2-10-11                    |                 |                     |



|                    |  |                 |  |
|--------------------|--|-----------------|--|
| <b>GEV No.</b>     | 109054   | <b>Ref. No.</b> | 12011332<br>12011699<br>12038573<br>R155013<br>R165011 |
| <b>description</b> | ignition pipe L 177mm ø 20mm   |                 |  |
| <b>For models:</b> | CG9-51L, CG9-51LC, CG9-51R, CG9-51RC, FTG7-05, FTG7-05L, FTG7-05R, FTG7-05VL, FTG7-05VR, FTG7-10, FTG7-10L, FTG7-10L+R, FTG7-10R, FTG7-10VL, FTG7-10VL+R, FTG7-10VR, FTG9-05L, FTG9-05R, FTG9-05VL, FTG9-05VR, FTG9-10L, FTG9-10L+R, FTG9-10R, FTG9-10VL, FTG9-10VL+R, FTG9-10VR, FTG9-11L, FTG9-11L+R, FTG9-11R, FTG9-11R+R, FTGC7-05L, FTGC7-10L, FTGC9-05, FTGC9-05L, FTGC9-05R, FTGC9-10, FTGC9-10L, FTGC9-10L+R, FTGC9-10R, FTGC9-11L, FTGC9-11L+R, FTGC9-11R, FTGC9-11R+R, SBG7-10, SBG9-10, SBG9-10I, SBG9-10IM, SBG9-10IMS, SBG9-10IS, SBG9-10M, SBG9-10MS, SBG9-10S...(Other models you can see in the webshop) |                 |  |



|                    |  |                 |                     |
|--------------------|--|-----------------|---------------------|
| <b>GEV No.</b>     | 101261                                     | <b>Ref. No.</b> | 12009969<br>U264301 |
| <b>description</b> | thermocouple fitting thread M9x1 Qty 1 pcs |                 |                     |

gas burners  
hob burners

interrupters





|                    |                         |                 |                     |
|--------------------|-------------------------|-----------------|---------------------|
| <b>GEV No.</b>     | 101264                  | <b>Ref. No.</b> | 12018684<br>X123002 |
| <b>description</b> | interrupter thread M8x1 |                 |                     |

producer-specific hob burners

FAGOR  
700, 900 series



|   |   |                 |                     |                                 |
|---|---|-----------------|---------------------|---------------------------------|
| <b>GEV No.</b>  | 109003  | <b>Ref. No.</b> | 12008071<br>U265702 |                                 |
| <b>description</b>  | air mixing sleeve ø 40mm L 55mm   |                 |                     |                                 |
| <b>For models:</b>  | CG-1002, CG-1502, CG-2000, CG-2000-2P, CG-2002, CG-2002P, CG-2005, CG-210, CG-210G, CG-300S, CG-310, CG-310G, CG7-20, CG7-200, CG7-20H, CG7-30D, CG7-30I, CG7-31D, CG7-31I, CG7-40, CG-7400, CG7-40H, CG7-41, CG-7415, CG7-41H, CG7-50, CG7-51, CG7-60, CG7-60H, CG7-61, CG-7615, CG7-61H, CG9-05AD, CG9-05PLUS, CG9-20, CG9-20AD, CG9-20AD-H, CG9-20H, CG9-20PLUS, CG9-20PLUS-H, CG9-31PLUS-D, CG9-31PLUS-I, CG9-40, CG9-40AD, CG9-40AD-H, CG9-40H, CG9-40PLUS, CG9-40PLUS-H, CG9-41, CG9-41AD...(Other models you can see in the webshop) |                 |                     |                                 |
| <b>accessories for</b>  | 109003  |                 |                     |                                 |
|  | <b>GEV No.</b>  | 109004          | <b>Ref. No.</b>     | 12009292<br>U445730             |
|  | <b>GEV No.</b>  | 109007          | <b>Ref. No.</b>     | 12007684<br>12040161<br>U565701 |

miscellaneous









|                    |  |                 |                     |
|--------------------|--|-----------------|---------------------|
| <b>GEV No.</b>     | 102449   | <b>Ref. No.</b> | 12023595<br>S223002 |
| <b>description</b> | circuit breaker cable L 450mm Qty 2 pcs  |                 |                     |
| <b>For models:</b> | FG6-05, FG6-10, MG7-10BM, MG9-10BM, MG9-10BMS, MG-9150BM, MG9-15BM, MG9-15BM316, MG9-15BMS, MPG9-10BM, MPG9-10BMS, MPG9-15BM, MPG9-15BMS |                 |                     |



Зип Общепит

vsezip.ru

+7(812)987-08-81

|   |                                 |                 |                                     |
|---|---------------------------------|-----------------|-------------------------------------|
|  |                                 |                 |                                     |
| 1   |                                 |                 |                                     |
| <b>GEV No.</b>  | 109024                          | <b>Ref. No.</b> | 12019997<br>U235704                 |
| <b>description</b>  | air mixing sleeve ø 46mm L 55mm |                 |                                     |
| <b>accessories for</b>  | 109024                          |                 |                                     |
|  | <b>GEV No.</b>                  | 109026          | <b>Ref. No.</b> 12013457<br>U235700 |
| burner head ø 120mm for burner cap ø 130mm 12kW                                   |                                 |                 |                                     |

|   |   |                 |   |
|---|---|-----------------|---|
|    |   |                 |   |
| 1   |   |                 |   |
| <b>GEV No.</b>  | 109005  | <b>Ref. No.</b> | 12008124<br>12039162<br>U445731<br>U4457315<br>U445731500   |
| <b>description</b>  | burner cap ø 100mm 4kW with central hole  |                 |   |
| <b>For models:</b>  | CG-1002, CG-1502, CG-2000, CG-2002, CG-2002P, CG-2005, CG-210, CG-210G, CG-300S, CG-310, CG-310G, CG-7-20, CG-7200, CG7-30D, CG7-30I, CG7-31D, CG7-31I, CG7-40, CG-7400, CG7-41, CG-7415, CG7-50, CG7-51, CG7-60, CG7-61, CG-7615, CG9-05AD, CG9-05PLUS, CG9-20, CG9-20AD, CG9-20H, CG9-20PLUS, CG9-31PLUS-D, CG9-31PLUS-I, CG9-40, CG9-40AD, CG9-40H, CG9-40PLUS, CG9-41, CG9-41AD, CG9-41H, CG9-41PLUS, CG9-51L, CG9-51LC, CG9-51R, CG9-51RC, CG9-60, CG9-60AD, CG9-60H, CG9-60PLUS...(Other models you can see in the webshop) |                 |   |
| <b>accessories for</b>  | 109005  |                 |   |
|  | <b>GEV No.</b>  | 109004          | <b>Ref. No.</b> 12009292<br>U445730                         |
| burner head ø 100mm 4.6kW   |   |                 |   |
|  | <b>GEV No.</b>  | 109704          | <b>Ref. No.</b> 12014055<br>U745417                         |
| drain tray L 340mm W 310mm H 41mm ø 130mm for burner cap ø 120mm                    |   |                 |   |
|  | <b>GEV No.</b>  | 109710          | <b>Ref. No.</b> 12005899<br>12038914<br>12120850<br>U505408 |
| drain tray L 420mm W 344mm H 39mm ø 115mm for burner cap ø 100mm                    |   |                 |   |

|  |   |                 |  |
|--|---|-----------------|--|
|  |   |                 |  |
| 1  |   |                 |  |
| <b>GEV No.</b>   | 109002  | <b>Ref. No.</b> | 12009109<br>12017945<br>U135702<br>U1357025<br>U135702500<br>U445732 |
| <b>description</b>   | burner cap ø 120mm 9.3kW with central hole  |                 |  |
| <b>For models:</b>   | CG-1002, CG-1502, CG-2000, CG-2000-2P, CG-2002, CG-2002P, CG-2005, CG-210, CG-210G, CG-300S, CG-310, CG-310G, CG-7115, CG-7200, CG7-20H, CG7-30D, CG7-30I, CG7-31D, CG7-31I, CG7-40, CG-7400, CG7-40H, CG7-41, CG-7415, CG7-41H, CG7-50, CG7-51, CG7-60, CG7-60H, CG7-61, CG-7615, CG7-61H, CG9-20, CG9-20AD, CG9-20AD-H, CG9-20H, CG9-20PLUS, CG9-20PLUS-H, CG9-31PLUS-D, CG9-31PLUS-I, CG9-40, CG9-40AD, CG9-40AD-H, CG9-40H, CG9-40PLUS, CG9-40PLUS-H, CG9-41, CG9-41AD, CG9-41AD-H, CG9-41H...(Other models you can see in the webshop) |                 |  |
| <b>accessories for</b>   | 109002  |                 |  |
|   | <b>GEV No.</b>  | 109007          | <b>Ref. No.</b> 12007684<br>12040161<br>U565701                      |
| burner head ø 120mm 7kW  |   |                 |  |

|   |  |                 |   |
|---|--|-----------------|---|
|  |  |                 |   |
| 1   |  |                 |   |
| <b>GEV No.</b>  | 109027   | <b>Ref. No.</b> | 12007682<br>12009367<br>12047137<br>U235701<br>U235701500 |
| <b>description</b>  | burner cap ø 130mm 11.6kW with central hole  |                 |   |
| <b>For models:</b>  | CG-1002, CG-1502, CG-2002, CG-2002P, CG9-20AD-H, CG9-20H, CG9-20PLUS-H, CG9-40, CG9-40AD, CG9-40AD-H, CG9-40H, CG9-40PLUS, CG9-40PLUS-H, CG9-41, CG9-41AD, CG9-41AD-H, CG9-41H, CG9-41PLUS, CG9-41PLUS-H, CG9-51L, CG9-51LC, CG9-51R, CG9-51RC, CG9-60, CG9-60AD, CG9-60AD-H, CG9-60H, CG9-60PLUS, CG9-60PLUS-H, CG9-61, CG9-61AD, CG9-61AD-H, CG9-61H, CG9-61OP, CG9-61PLUS, CG9-61PLUS-H, CG9-82, CG9-82AD, CG9-82PLUS, CGE9-41, CGE9-41AD, CGE9-41PLUS, HP-G-15, HPG-15 |                 |   |
| <b>accessories for</b>  | 109027   |                 |   |
|  | <b>GEV No.</b>   | 109026          | <b>Ref. No.</b> 12013457<br>U235700                       |
| burner head ø 120mm for burner cap ø 130mm 12kW                                     |  |                 |   |









Зип Общепит





vsezip.ru

+7(812)987-08-81

|  |   |                 |   |
|--|---|-----------------|---|
|  <p>1</p> |   |                 |   |
| <b>GEV No.</b>   | 109004  | <b>Ref. No.</b> | 12009292<br>U445730                                       |
| <b>description</b>   | burner head ø 100mm 4.6kW   |                 |   |
| <b>For models:</b>   | CG-1002, CG-1502, CG-2000, CG-2002, CG-2005, CG-210, CG-210G, CG-300S, CG-310, CG-310G, CG7-20, CG-7200, CG7-40, CG-7400, CG7-41, CG-7415, CG7-61, CG-7615, CG9-20, CG9-40, CG9-41, CG9-51L, CG9-51LC, CG9-51R, CG9-51RC, CG9-60, CG9-61, CG9-82, CGB7-61, CGE7-118, CGE7-41, CGE9-41 |                 |   |
| <b>accessories for</b>   | 109004  |                 |   |
|           | <b>GEV No.</b>  | 109001          | <b>Ref. No.</b>   |
|  |   |                 | 12009400<br>U125720                                       |
|  | venturi ø 11.5mm L 90mm   |                 |   |
|           | <b>GEV No.</b>  | 109003          | <b>Ref. No.</b>   |
|  |   |                 | 12008071<br>U265702                                       |
|  | air mixing sleeve ø 40mm L 55mm   |                 |   |
|           | <b>GEV No.</b>  | 109005          | <b>Ref. No.</b>   |
|  |   |                 | 12008124<br>12039162<br>U445731<br>U4457315<br>U445731500 |
|  | burner cap ø 100mm 4kW with central hole  |                 |   |

|   |  |                 |  |
|---|--|-----------------|--|
|  <p>1</p> |  |                 |  |
| <b>GEV No.</b>  | 109205   | <b>Ref. No.</b> | 12008471<br>U915702000   |
| <b>description</b>  | burner head ø 120mm 7kW suitable for FAGOR   |                 |  |
| <b>For models:</b>  | CG7-20H, CG7-30D, CG7-30I, CG7-31D, CG7-31I, CG7-40, CG7-40H, CG7-41, CG7-41H, CG7-50, CG7-51, CG7-60, CG7-60H, CG7-61, CG7-61H, CGB7-61, CGB7-61H, CGB7-61R, CGB7-61RH, CGE7-41, CGE7-41H |                 |  |
| <b>accessories for</b>  | 109205   |                 |  |
|            | <b>GEV No.</b>   | 109002          | <b>Ref. No.</b>  |
|   |  |                 | 12009109<br>12017945<br>U135702<br>U1357025<br>U135702500<br>U445732 |
|   | burner cap ø 120mm 9.3kW with central hole   |                 |  |

|  |   |                 |  |
|--|---|-----------------|--|
|  <p>1</p> |   |                 |  |
| <b>GEV No.</b>   | 109007  | <b>Ref. No.</b> | 12007684<br>12040161<br>U565701                                      |
| <b>description</b>   | burner head ø 120mm 7kW   |                 |  |
| <b>For models:</b>   | CG-1002, CG-1502, CG-2000, CG-2000-2P, CG-2002, CG-2005, CG-210, CG-210G, CG-300S, CG-310, CG-310G, CG7-40, CG7-41, CG7-61, CG9-20, CG9-40, CG9-41, CG9-51L, CG9-51LC, CG9-51R, CG9-51RC, CG9-60, CG9-61, CG9-82, CGB7-61, CGE7-108, CGE7-41, CGE9-41 |                 |  |
| <b>accessories for</b>   | 109007  |                 |  |
|           | <b>GEV No.</b>  | 109002          | <b>Ref. No.</b>  |
|  |   |                 | 12009109<br>12017945<br>U135702<br>U1357025<br>U135702500<br>U445732 |
|  | burner cap ø 120mm 9.3kW with central hole  |                 |  |
|           | <b>GEV No.</b>  | 109003          | <b>Ref. No.</b>  |
|  |   |                 | 12008071<br>U265702  |
|  | air mixing sleeve ø 40mm L 55mm   |                 |  |
|           | <b>GEV No.</b>  | 109006          | <b>Ref. No.</b>  |
|  |   |                 | 12008429<br>U565700  |
|  | venturi ø 27.7mm L 90mm   |                 |  |



|  |  |                 |   |
|--|--|-----------------|---|
|  <p>1</p> |  |                 |   |
| <b>GEV No.</b>   | 109026   | <b>Ref. No.</b> | 12013457<br>U235700                                       |
| <b>description</b>   | burner head ø 120mm for burner cap ø 130mm 12kW  |                 |   |
| <b>For models:</b>   | CG-1002, CG-1502, CG-2002, CG9-40, CG9-41, CG9-51L, CG9-51LC, CG9-51R, CG9-51RC, CG9-60, CG9-61, CG9-82, CGE9-41 |                 |   |
| <b>accessories for</b>   | 109026   |                 |   |
|           | <b>GEV No.</b>   | 109024          | <b>Ref. No.</b>   |
|  |  |                 | 12019997<br>U235704                                       |
|  | air mixing sleeve ø 46mm L 55mm  |                 |   |
|           | <b>GEV No.</b>   | 109025          | <b>Ref. No.</b>   |
|  |  |                 | 12008019<br>12008611<br>U235702                           |
|  | venturi ø 40mm L 160mm   |                 |   |
|           | <b>GEV No.</b>   | 109027          | <b>Ref. No.</b>   |
|  |  |                 | 12007682<br>12009367<br>12047137<br>U235701<br>U235701500 |
|  | burner cap ø 130mm 11.6kW with central hole  |                 |   |



1 gas components



Зип Общепит

vsezip.ru

(812)987-0870

|   |  |                 |                                     |
|---|--|-----------------|-------------------------------------|
|  |  |                 |                                     |
| <b>GEV No.</b>  | 109001   | <b>Ref. No.</b> | 12009400<br>U125720                 |
| <b>description</b>  | venturi ø 11.5mm L 90mm  |                 |                                     |
| <b>For models:</b>  | CG-1002, CG-1502, CG-2000, CG-2002, CG-2002P, CG-2005, CG-210, CG-210G, CG-300S, CG-310, CG-310G, CG7-20, CG-7200, CG7-30D, CG7-30I, CG7-31D, CG7-31I, CG7-40, CG-7400, CG7-41, CG-7415, CG7-50, CG7-51, CG7-60, CG7-61, CG-7615, CG9-05AD, CG9-05PLUS, CG9-20, CG9-20AD, CG9-20H, CG9-20PLUS, CG9-31PLUS-D, CG9-31PLUS-I, CG9-40, CG9-40AD, CG9-40H, CG9-40PLUS, CG9-41, CG9-41AD, CG9-41H, CG9-41PLUS, CG9-51L, CG9-51LC, CG9-51R, CG9-51RC, CG9-60, CG9-60AD, CG9-60H, CG9-60PLUS...(Other models you can see in the webshop) |                 |                                     |
| <b>accessories for</b>  | 109001   |                 |                                     |
|  | <b>GEV No.</b>   | 109004          | <b>Ref. No.</b> 12009292<br>U445730 |
| burner head ø 100mm 4.6kW   |  |                 |                                     |





|   |   |                 |   |
|---|---|-----------------|---|
|    |   |                 |   |
| <b>GEV No.</b>  | 109006  | <b>Ref. No.</b> | 12008429<br>U565700                             |
| <b>description</b>  | venturi ø 27.7mm L 90mm   |                 |   |
| <b>For models:</b>  | CG-1002, CG-1502, CG-2000, CG-2000-2P, CG-2002, CG-2002P, CG-2005, CG-210, CG-210G, CG-300S, CG-310, CG-310G, CG7-20H, CG7-30D, CG7-30I, CG7-31D, CG7-31I, CG7-40, CG7-40H, CG7-41, CG7-41H, CG7-50, CG7-51, CG7-60, CG7-60H, CG7-61, CG7-61H, CG9-20, CG9-20AD, CG9-20AD-H, CG9-20H, CG9-20PLUS, CG9-20PLUS-H, CG9-31PLUS-D, CG9-31PLUS-I, CG9-40, CG9-40AD, CG9-40AD-H, CG9-40H, CG9-40PLUS, CG9-40PLUS-H, CG9-41, CG9-41AD, CG9-41AD-H, CG9-41H, CG9-41PLUS, CG9-41PLUS-H, CG9-51L, CG9-51LC, CG9-51R... |                 |   |
| <b>accessories for</b>  | 109006  |                 |   |
|  | <b>GEV No.</b>  | 109007          | <b>Ref. No.</b> 12007684<br>12040161<br>U565701 |
| burner head ø 120mm 7kW   |   |                 |   |

|   |   |                 |                                     |
|---|---|-----------------|-------------------------------------|
|  |   |                 |                                     |
| <b>GEV No.</b>  | 109025  | <b>Ref. No.</b> | 12008019<br>12008611<br>U235702     |
| <b>description</b>  | venturi ø 40mm L 160mm  |                 |                                     |
| <b>For models:</b>  | CG-1002, CG-1502, CG-2002, CG-2002P, CG9-40, CG9-41, CG9-51L, CG9-51LC, CG9-51R, CG9-51RC, CG9-60, CG9-61, CG9-82, CG9-41 |                 |                                     |
| <b>accessories for</b>  | 109025  |                 |                                     |
|  | <b>GEV No.</b>  | 109026          | <b>Ref. No.</b> 12013457<br>U235700 |
| burner head ø 120mm for burner cap ø 130mm 12kW                                     |   |                 |                                     |

900 (since 2006) series

|   |  |                 |                     |
|---|--|-----------------|---------------------|
|  |  |                 |                     |
| <b>GEV No.</b>  | 109062   | <b>Ref. No.</b> | 12008073<br>U025706 |
| <b>description</b>  | air mixing sleeve L 56mm D1 ø 49mm D2 ø 51mm   |                 |                     |
| <b>For models:</b>  | CG-1002, CG-1502, CG-2002, CG-2002P, CG9-20AD-H, CG9-20H, CG9-20PLUS-H, CG9-40, CG9-40AD, CG9-40AD-H, CG9-40H, CG9-40PLUS, CG9-40PLUS-H, CG9-41, CG9-41AD, CG9-41AD-H, CG9-41H, CG9-41PLUS, CG9-41PLUS-H, CG9-51L, CG9-51LC, CG9-51R, CG9-51RC, CG9-60, CG9-60AD, CG9-60AD-H, CG9-60H, CG9-60PLUS, CG9-60PLUS-H, CG9-61, CG9-61AD, CG9-61AD-H, CG9-61H, CG9-61OP, CG9-61PLUS, CG9-61PLUS-H, CG9-82, CG9-82AD, CG9-82PLUS, CG9-41, CG9-41AD, CG9-41PLUS |                 |                     |

|   |   |                 |   |
|---|---|-----------------|---|
|  |   |                 |   |
| <b>GEV No.</b>  | 109003  | <b>Ref. No.</b> | 12008071<br>U265702                             |
| <b>description</b>  | air mixing sleeve ø 40mm L 55mm   |                 |   |
| <b>For models:</b>  | CG-1002, CG-1502, CG-2000, CG-2000-2P, CG-2002, CG-2002P, CG-2005, CG-210, CG-210G, CG-300S, CG-310, CG-310G, CG7-20, CG-7200, CG7-30D, CG7-30I, CG7-31D, CG7-31I, CG7-40, CG-7400, CG7-41, CG-7415, CG7-41H, CG7-50, CG7-51, CG7-60, CG7-60H, CG7-61, CG-7615, CG7-61H, CG9-05AD, CG9-05PLUS, CG9-20, CG9-20AD, CG9-20AD-H, CG9-20H, CG9-20PLUS, CG9-20PLUS-H, CG9-31PLUS-D, CG9-31PLUS-I, CG9-40, CG9-40AD, CG9-40AD-H, CG9-40H, CG9-40PLUS, CG9-40PLUS-H, CG9-41, CG9-41AD...(Other models you can see in the webshop) |                 |   |
| <b>accessories for</b>  | 109003  |                 |   |
|  | <b>GEV No.</b>  | 109004          | <b>Ref. No.</b> 12009292<br>U445730             |
| burner head ø 100mm 4.6kW   |   |                 |   |
|  | <b>GEV No.</b>  | 109007          | <b>Ref. No.</b> 12007684<br>12040161<br>U565701 |
| burner head ø 120mm 7kW   |   |                 |   |

|   |  |                 |   |
|---|--|-----------------|---|
|    |  |                 |   |
| <b>GEV No.</b>  | 109005   | <b>Ref. No.</b> | 12008124<br>12039162<br>U445731<br>U4457315<br>U445731500   |
| <b>description</b>  | burner cap ø 100mm 4kW with central hole   |                 |   |
| <b>For models:</b>  | CG-1002, CG-1502, CG-2000, CG-2002, CG-2002P, CG-2005, CG-210, CG-210G, CG-300S, CG-310, CG-310G, CG7-20, CG-7200, CG7-30D, CG7-30I, CG7-31D, CG7-31I, CG7-40, CG-7400, CG7-41, CG-7415, CG7-50, CG7-51, CG7-60, CG7-61, CG-7615, CG9-05AD, CG9-05PLUS, CG9-20, CG9-20AD, CG9-20H, CG9-20PLUS, CG9-31PLUS-D, CG9-31PLUS-I, CG9-40, CG9-40AD, CG9-40H, CG9-40PLUS, CG9-41, CG9-41AD, CG9-41H, CG9-41PLUS, CG9-51L, CG9-51LC, CG9-51R, CG9-51RC, CG9-60, CG9-60AD, CG9-60H, CG9-60PLUS...(Other models you can see in the webshop) |                 |   |
| <b>accessories for</b>  | 109005   |                 |   |
|  | <b>GEV No.</b>   | 109004          | <b>Ref. No.</b> 12009292<br>U445730                         |
| burner head ø 100mm 4.6kW   |  |                 |   |
|  | <b>GEV No.</b>   | 109704          | <b>Ref. No.</b> 12014055<br>U745417                         |
| drain tray L 340mm W 310mm H 41mm ø 130mm for burner cap ø 120mm                    |  |                 |   |
|  | <b>GEV No.</b>   | 109710          | <b>Ref. No.</b> 12005899<br>12038914<br>12120850<br>U505408 |
| drain tray L 420mm W 344mm H 39mm ø 115mm for burner cap ø 100mm                    |  |                 |   |



Зип Общепит

vsezip.ru

(812)987-08-81



|  |  |                 |  |
|--|--|-----------------|--|
|  <p>1</p> |  |                 |  |
| <b>GEV No.</b>   | 109002   | <b>Ref. No.</b> | 12009109<br>12017945<br>U135702<br>U1357025<br>U135702500<br>U445732 |
| <b>description</b>   | burner cap ø 120mm 9.3kW with central hole   |                 |  |
| <b>For models:</b>   | CG-1002, CG-1502, CG-2000, CG-2000-2P, CG-2002, CG-2002P, CG-2005, CG-210, CG-210G, CG-300S, CG-310, CG-310G, CG-7115, CG-7200, CG7-20H, CG7-30D, CG7-30I, CG7-31D, CG7-31I, CG7-40, CG-7400, CG7-40H, CG7-41, CG-7415, CG7-41H, CG7-50, CG7-51, CG7-60, CG7-60H, CG7-61, CG-7615, CG7-61H, CG9-20, CG9-20AD, CG9-20AD-H, CG9-20H, CG9-20PLUS, CG9-20PLUS-H, CG9-31PLUS-D, CG9-31PLUS-I, CG9-40, CG9-40AD, CG9-40AD-H, CG9-40H, CG9-40PLUS, CG9-40PLUS-H, CG9-41, CG9-41AD, CG9-41AD-H, CG9-41H... (Other models you can see in the webshop) |                 |  |
| <b>accessories for</b>   | 109002   |                 |  |
|           | <b>GEV No.</b>   | 109007          | <b>Ref. No.</b>  |
|  |  |                 | 12007684<br>12040161<br>U565701                                      |
|  | burner head ø 120mm 7kW  |                 |  |

|   |  |                 |   |
|---|--|-----------------|---|
|  <p>1</p> |  |                 |   |
| <b>GEV No.</b>  | 109027   | <b>Ref. No.</b> | 12007682<br>12009367<br>12047137<br>U235701<br>U235701500 |
| <b>description</b>  | burner cap ø 130mm 11.6kW with central hole  |                 |   |
| <b>For models:</b>  | CG-1002, CG-1502, CG-2002, CG-2002P, CG9-20AD-H, CG9-20H, CG9-20PLUS-H, CG9-40, CG9-40AD, CG9-40AD-H, CG9-40H, CG9-40PLUS, CG9-40PLUS-H, CG9-41, CG9-41AD, CG9-41AD-H, CG9-41H, CG9-41PLUS, CG9-41PLUS-H, CG9-51L, CG9-51LC, CG9-51R, CG9-51RC, CG9-60, CG9-60AD, CG9-60AD-H, CG9-60H, CG9-60PLUS, CG9-60PLUS-H, CG9-61, CG9-61AD, CG9-61AD-H, CG9-61H, CG9-61OP, CG9-61PLUS, CG9-61PLUS-H, CG9-82, CG9-82AD, CG9-82PLUS, CGE9-41, CGE9-41AD, CGE9-41PLUS, HP-G-15, HPG-15 |                 |   |
| <b>accessories for</b>  | 109027   |                 |   |
|          | <b>GEV No.</b>   | 109026          | <b>Ref. No.</b>   |
|   |  |                 | 12013457<br>U235700                                       |
|   | burner head ø 120mm for burner cap ø 130mm 12kW  |                 |   |

|  |  |                 |                     |
|--|--|-----------------|---------------------|
|  <p>1</p> |  |                 |                     |
| <b>GEV No.</b>   | 109063   | <b>Ref. No.</b> | 12009498<br>U025701 |
| <b>description</b>   | burner head ø 100mm 4.7kW 4kcal for burner cap ø 100mm L 280mm H 113mm   |                 |                     |
| <b>For models:</b>   | CG-1002, CG-1502, CG-2002, CG-2002P, CG9-20, CG9-40, CG9-41, CG9-51L, CG9-51LC, CG9-51R, CG9-51RC, CG9-60, CG9-61, CG9-82, CGE9-41, CGF9-120D, CGF9-120I, CGF9-121D, CGF9-121I |                 |                     |

|  |  |                 |                     |
|--|--|-----------------|---------------------|
|  |  |                 |                     |
| <b>GEV No.</b>   | 109106   | <b>Ref. No.</b> | 12009326<br>U025702 |
| <b>description</b>   | burner head ø 118mm 9.3kW 8000kcal for burner cap ø 120mm L 280mm H 90mm   |                 |                     |
| <b>For models:</b>   | CG-1002, CG-1502, CG-2002, CG-2002P, CG9-20, CG9-40, CG9-41, CG9-51L, CG9-51LC, CG9-51R, CG9-51RC, CG9-60, CG9-61, CG9-82, CGE9-41, CGF9-120D, CGF9-120I, CGF9-121D, CGF9-121I |                 |                     |

|   |  |                 |                     |
|---|--|-----------------|---------------------|
|  <p>1</p> |  |                 |                     |
| <b>GEV No.</b>  | 109102   | <b>Ref. No.</b> | 12008525<br>U025703 |
| <b>description</b>  | burner head ø 120mm 11.6kW for burner cap ø 130mm L 280mm H 94mm   |                 |                     |
| <b>For models:</b>  | CG-1002, CG-1502, CG-2002, CG-2002P, CG9-40, CG9-41, CG9-51L, CG9-51LC, CG9-51R, CG9-51RC, CG9-60, CG9-61, CG9-82, CGE9-41 |                 |                     |
| <b>accessories for</b>  | 109102   |                 |                     |
|          | <b>GEV No.</b>   | 109003          | <b>Ref. No.</b>     |
|   |  |                 | 12008071<br>U265702 |
|   | air mixing sleeve ø 40mm L 55mm  |                 |                     |

|  |  |                 |                     |
|--|--|-----------------|---------------------|
|  <p>1</p> |  |                 |                     |
| <b>GEV No.</b>   | 109001   | <b>Ref. No.</b> | 12009400<br>U125720 |
| <b>description</b>   | venturi ø 11.5mm L 90mm  |                 |                     |
| <b>For models:</b>   | CG-1002, CG-1502, CG-2000, CG-2002, CG-2002P, CG-2005, CG-210, CG-210G, CG-300S, CG-310, CG-310G, CG7-20, CG-7200, CG7-30D, CG7-30I, CG7-31D, CG7-31I, CG7-40, CG-7400, CG7-41, CG-7415, CG7-50, CG7-51, CG7-60, CG7-61, CG-7615, CG9-05AD, CG9-05PLUS, CG9-20, CG9-20AD, CG9-20H, CG9-20PLUS, CG9-31PLUS-D, CG9-31PLUS-I, CG9-40, CG9-40AD, CG9-40H, CG9-40PLUS, CG9-41, CG9-41AD, CG9-41H, CG9-41PLUS, CG9-51L, CG9-51LC, CG9-51R, CG9-51RC, CG9-60, CG9-60AD, CG9-60H, CG9-60PLUS...(Other models you can see in the webshop) |                 |                     |
| <b>accessories for</b>   | 109001   |                 |                     |
|           | <b>GEV No.</b>   | 109004          | <b>Ref. No.</b>     |
|  |  |                 | 12009292<br>U445730 |
|  | burner head ø 100mm 4.6kW  |                 |                     |

1 gas components

Зип Общепит

vsezip.ru  
(812)987-08811 

|   |   |                 |  |
|---|---|-----------------|--|
| <b>GEV No.</b>  | 109006  | <b>Ref. No.</b> | 12008429<br>U565700                                |
| <b>description</b>  | venturi ø 27.7mm L 90mm   |                 |  |
| <b>For models:</b>  | CG-1002, CG-1502, CG-2000, CG-2000-2P, CG-2002, CG-2002P, CG-2005, CG-210, CG-210G, CG-300S, CG-310, CG-310.5, CG-7-20H, CG-7-30D, CG-7-30L, CG-7-31D, CG-7-31H, CG-7-40, CG-7-40H, CG-7-41, CG-7-41H, CG-7-50, CG-7-51, CG-7-60, CG-7-60H, CG-7-61, CG-7-61H, CG-9-20, CG-9-20AD, CG-9-20AD-H, CG-9-20H, CG-9-20PLUS, CG-9-20PLUS-H, CG-9-31PLUS-D, CG-9-31PLUS-I, CG-9-40, CG-9-40AD, CG-9-40AD-H, CG-9-40H, CG-9-40PLUS, CG-9-40PLUS-H, CG-9-41, CG-9-41AD, CG-9-41AD-H, CG-9-41H, CG-9-41PLUS, CG-9-41PLUS-H, CG-9-51L, CG-9-51LC, CG-9-51R...<br>(Other models you can see in the webshop) |                 |  |
| <b>accessories for</b>  | 109006  |                 |  |
|  | <b>GEV No.</b>  | 109007          | <b>Ref. No.</b><br>12007684<br>12040161<br>U565701 |
| burner head ø 120mm 7kW   |   |                 |  |

1 



|   |   |                 |  |
|---|---|-----------------|--|
| <b>GEV No.</b>  | 109025  | <b>Ref. No.</b> | 12008019<br>12008611<br>U235702        |
| <b>description</b>  | venturi ø 40mm L 160mm  |                 |  |
| <b>For models:</b>  | CG-1002, CG-1502, CG-2002, CG-2002P, CG-9-40, CG-9-41, CG-9-51L, CG-9-51LC, CG-9-51R, CG-9-51RC, CG-9-60, CG-9-61, CG-9-82, CGE9-41 |                 |  |
| <b>accessories for</b>  | 109025  |                 |  |
|  | <b>GEV No.</b>  | 109026          | <b>Ref. No.</b><br>12013457<br>U235700 |
| burner head ø 120mm for burner cap ø 130mm 12kW                                   |   |                 |  |

## solid tops / stockpot stoves



1 

|                    |                 |                 |         |
|--------------------|-----------------|-----------------|---------|
| <b>GEV No.</b>     | 109031          | <b>Ref. No.</b> | U195704 |
| <b>description</b> | air mixing tube |                 |         |



1 

|  |  |                 |  |
|--|--|-----------------|--|
| <b>GEV No.</b>   | 109014   | <b>Ref. No.</b> | 12009172<br>12040022<br>U195701<br>U1957015<br>U195701500        |
| <b>description</b>   | burner cap ø 120mm with central hole   |                 |  |
| <b>For models:</b>   | CG-110, CG-7-10, CG-7-11, CG-9-10, CG-9-10AD, CG-9-10PLUS, CG-9-11, CG-9-11PLUS, CGE9-11, CGF9-120D, CGF9-120D-AD, CGF9-120I, CGF9-120I-AD, CGF9-120PLUS-D, CGF9-120PLUS-I, CGF9-121D, CGF9-121D-AD, CGF9-121I, CGF9-121I-AD, CGF9-121PLUS-D, CGF9-121PLUS-I |                 |  |
| <b>accessories for</b>   | 109014   |                 |  |
|  | <b>GEV No.</b>   | 109015          | <b>Ref. No.</b><br>12007687<br>U195702                           |
| burner head for burner cap ø 120mm   |  |                 |  |
|  | <b>GEV No.</b>   | 109016          | <b>Ref. No.</b><br>12009160<br>U775701                           |
| venturi  |  |                 |  |
|  | <b>GEV No.</b>   | 109017          | <b>Ref. No.</b><br>12009164<br>12014412<br>U615700<br>U615700500 |
| burner holder  |  |                 |  |

1

|   |  |                 |  |
|---|--|-----------------|--|
| <b>GEV No.</b>  | 109015   | <b>Ref. No.</b> | 12007687<br>U195702  |
| <b>description</b>  | burner head for burner cap ø 120mm   |                 |  |
| <b>For models:</b>  | CG-110, CG-7-10, CG-7-11, CG-7115, CG-9-10, CG-9-10AD, CG-9-10PLUS, CG-9-11, CG-9110, CG-9-11AD, CG-9-11PLUS, CGE9-11, CGF9-120D, CGF9-120D-AD, CGF9-120I, CGF9-120I-AD, CGF9-120PLUS-D, CGF9-120PLUS-I, CGF9-121D, CGF9-121D-AD, CGF9-121I, CGF9-121I-AD, CGF9-121PLUS-D, CGF9-121PLUS-I, HP-G-15, HPG-15 |                 |  |
| <b>accessories for</b>  | 109015   |                 |  |
|  | <b>GEV No.</b>   | 109014          | <b>Ref. No.</b><br>12009172<br>12040022<br>U195701<br>U1957015<br>U195701500 |
| burner cap ø 120mm with central hole  |  |                 |  |
|  | <b>GEV No.</b>   | 109016          | <b>Ref. No.</b><br>12009160<br>U775701                                       |
| venturi   |  |                 |  |
|  | <b>GEV No.</b>   | 109017          | <b>Ref. No.</b><br>12009164<br>12014412<br>U615700<br>U615700500             |
| burner holder   |  |                 |  |

1 





|   |  |                 |  |
|---|--|-----------------|--|
| <b>GEV No.</b>  | 109017   | <b>Ref. No.</b> | 12009164<br>12014412<br>U615700<br>U615700500                                |
| <b>description</b>  | burner holder  |                 |  |
| <b>For models:</b>  | CG-7-10, CG-7-11, CG-9-10, CG-9-10AD, CG-9-10PLUS, CG-9-11, CG-9-11AD, CG-9-11PLUS, CGE9-11, CGF9-120D, CGF9-120D-AD, CGF9-120I, CGF9-120I-AD, CGF9-120PLUS-D, CGF9-120PLUS-I, CGF9-121D, CGF9-121D-AD, CGF9-121I, CGF9-121I-AD, CGF9-121PLUS-D, CGF9-121PLUS-I, HP-G-15, HPG-15 |                 |  |
| <b>accessories for</b>  | 109017   |                 |  |
|  | <b>GEV No.</b>   | 109014          | <b>Ref. No.</b><br>12009172<br>12040022<br>U195701<br>U1957015<br>U195701500 |
| burner cap ø 120mm with central hole  |  |                 |  |
|  | <b>GEV No.</b>   | 109015          | <b>Ref. No.</b><br>12007687<br>U195702                                       |
| burner head for burner cap ø 120mm  |  |                 |  |
|  | <b>GEV No.</b>   | 109016          | <b>Ref. No.</b><br>12009160<br>U775701                                       |
| venturi   |  |                 |  |



Зип Общепит

vsezip.ru

8(2)987-08-81

|   |  |                 |  |
|---|--|-----------------|--|
| 1  |  |                 |  |
| <b>GEV No.</b>  | 109016   | <b>Ref. No.</b> | 12009160<br>U775701  |
| <b>description</b>  | venturi  |                 |  |
| <b>For models:</b>  | CG7-10, CG7-11, CG9-10, CG9-10AD, CG9-10PLUS, CG9-11, CG9-11AD, CG9-11PLUS, CGE9-11, CGF9-120D, CGF9-120D-AD, CGF9-120I, CGF9-120I-AD, CGF9-120PLUS-D, CGF9-120PLUS-I, CGF9-121D, CGF9-121D-AD, CGF9-121I, CGF9-121I-AD, CGF9-121PLUS-D, CGF9-121PLUS-I, HP-G-15, HPG-15 |                 |  |
| <b>accessories for</b>  | 109016   |                 |  |
|    | <b>GEV No.</b>   | 109014          | <b>Ref. No.</b><br>12009172<br>12040022<br>U195701<br>U1957015<br>U195701500 |
| burner cap ø 120mm with central hole  |  |                 |  |
|    | <b>GEV No.</b>   | 109015          | <b>Ref. No.</b><br>12007687<br>U195702                                       |
| burner head for burner cap ø 120mm  |  |                 |  |
|    | <b>GEV No.</b>   | 109017          | <b>Ref. No.</b><br>12009164<br>12014412<br>U615700<br>U615700500             |
| burner holder   |  |                 |  |

|  |   |                 |                     |
|--|---|-----------------|---------------------|
| 1  |   |                 |                     |
| <b>GEV No.</b>   | 109702  | <b>Ref. No.</b> | 12016262<br>U745413 |
| <b>description</b>   | pan support W 310mm L 350mm suitable for FAGOR for burner cap ø 100mm |                 |                     |
| <b>For models:</b>   | CG7-20, CG7-40, CG7-41, CG7-61, CGE7-88                               |                 |                     |

|  |   |                 |                     |
|--|---|-----------------|---------------------|
| 1  |   |                 |                     |
| <b>GEV No.</b>   | 109701  | <b>Ref. No.</b> | 12016263<br>U745412 |
| <b>description</b>   | pan support W 310mm L 350mm suitable for FAGOR for burner cap ø 120mm |                 |                     |
| <b>For models:</b>   | CG7-20, CG7-40, CG7-41, CG7-61, CGE7-89                               |                 |                     |

|  |  |                 |                     |
|--|--|-----------------|---------------------|
| <b>pan supports</b>  |  |                 |                     |
| 1  |  |                 |                     |
| <b>GEV No.</b>   | 109705   | <b>Ref. No.</b> | 12016228<br>U745415 |
| <b>description</b>   | pan support W 310mm L 345mm H 50mm suitable for FAGOR black, varnished |                 |                     |
| <b>For models:</b>   | CG7-20, CG7-40, CG7-41, CG7-61, CGB7-61, CGE7-41                       |                 |                     |

|   |   |                 |                     |
|---|---|-----------------|---------------------|
| 1  |   |                 |                     |
| <b>GEV No.</b>  | 109716  | <b>Ref. No.</b> | 12007691<br>U565403 |
| <b>description</b>  | pan support W 345mm L 425mm   |                 |                     |
| <b>For models:</b>  | CG-1002, CG-1502, CG-2000, CG-2000-2P, CG-2002, CG-2005, CG-210, CG-210G, CG-3005, CG-310, CG-310G, CG9-20, CG9-40, CG9-41, CG9-51L, CG9-51LC, CG9-51R, CG9-51RC, CG9-60, CG9-61, CG9-82, CGE9-41 |                 |                     |

|   |  |                 |                     |
|---|--|-----------------|---------------------|
| 1  |  |                 |                     |
| <b>GEV No.</b>  | 109069   | <b>Ref. No.</b> | 12009419<br>U915413 |
| <b>description</b>  | pan support W 310mm L 348mm H 54mm suitable for FAGOR cast iron  |                 |                     |
| <b>For models:</b>  | CG7-20, CG7-20H, CG7-30D, CG7-30I, CG7-31D, CG7-31I, CG7-40, CG7-40H, CG7-41, CG7-41H, CG7-50, CG7-51, CG7-60, CG7-60H, CG7-61, CG7-61H, CGB7-61, CGB7-61H, CGB7-61R, CGB7-61RH, CGE7-41, CGE7-41H |                 |                     |

|  |  |                 |                     |
|--|--|-----------------|---------------------|
| <b>spillage trays</b>  |  |                 |                     |
| 1  |  |                 |                     |
| <b>GEV No.</b>   | 109703   | <b>Ref. No.</b> | 12014294<br>U745416 |
| <b>description</b>   | drain tray L 340mm W 310mm H 38mm ø 115mm for burner cap ø 100mm |                 |                     |
| <b>For models:</b>   | CG7-20, CG7-40, CG7-41, CG7-61, CGB7-61, CGE7-41                 |                 |                     |

1 gas components

Зип-Общепит

solid tops

vsezip.ru

+7(812)987-08-81

|   |   |                 |                     |
|---|---|-----------------|---------------------|
|  |   |                 |                     |
| 1   |   |                 |                     |
| <b>GEV No.</b>  | 109706  | <b>Ref. No.</b> | 12002032<br>U025404 |
| <b>description</b>  | drain tray L 405mm W 348mm H 50mm for burner cap ø 100mm  |                 |                     |
| <b>For models:</b>  | CG-1002, CG-1502, CG9-20, CG9-40, CG9-41, CG9-51L, CG9-51LC, CG9-51R, CG9-51RC, CG9-60, CG9-61, CG9-82, CGE9-41, CGF9-120D, CGF9-120I, CGF9-121D, CGF9-121I |                 |                     |

|   |  |                 |                     |
|---|--|-----------------|---------------------|
|  |  |                 |                     |
| 1   |  |                 |                     |
| <b>GEV No.</b>  | 109721   | <b>Ref. No.</b> | 12002033<br>U025405 |
| <b>description</b>  | drain tray L 405mm W 348mm H 50mm for burner cap ø 120mm   |                 |                     |
| <b>For models:</b>  | CG-1002, CG-1502, CG-2002, CG-2002P, CG9-20, CG9-40, CG9-41, CG9-51L, CG9-51LC, CG9-51R, CG9-51RC, CG9-60, CG9-61, CG9-82, CGE9-41, CGF9-120D, CGF9-120I, CGF9-121D, CGF9-121I |                 |                     |

|  |   |                 |   |
|--|---|-----------------|---|
|  |   |                 |   |
| 1  |   |                 |   |
| <b>GEV No.</b>   | 109710  | <b>Ref. No.</b> | 12005899<br>12038914<br>12120850<br>U505408 |
| <b>description</b>   | drain tray L 420mm W 344mm H 39mm ø 115mm for burner cap ø 100mm  |                 |   |
| <b>For models:</b>   | CG-1002, CG-1502, CG-2005, CG-210, CG-210G, CG-300S, CG-310, CG-310G, CG9-20, CG9-40, CG9-41, CG9-51L, CG9-51LC, CG9-51R, CG9-51RC, CG9-60, CG9-61, CG9-82, CGE9-41 |                 |   |

|   |   |                 |                                 |
|---|---|-----------------|---------------------------------|
|  |   |                 |                                 |
| 1   |   |                 |                                 |
| <b>GEV No.</b>  | 109711  | <b>Ref. No.</b> | 12005898<br>12038913<br>U505409 |
| <b>description</b>  | drain tray L 420mm W 344mm H 45mm ø 140mm for burner cap ø 120mm  |                 |                                 |
| <b>For models:</b>  | CG-1002, CG-1502, CG-2000, CG-2000-2P, CG-2002, CG-2005, CG-210, CG-210G, CG-300S, CG-310, CG-310G, CG9-20, CG9-40, CG9-41, CG9-51L, CG9-51LC, CG9-51R, CG9-51RC, CG9-60, CG9-61, CG9-82, CGE9-41 |                 |                                 |

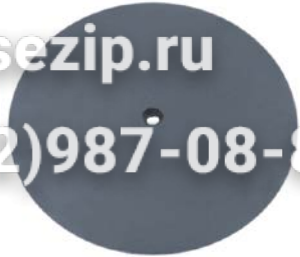
|  |  |                 |                     |
|--|--|-----------------|---------------------|
|  |  |                 |                     |
| 1  |  |                 |                     |
| <b>GEV No.</b>   | 109087   | <b>Ref. No.</b> | 12007681<br>U195421 |
| <b>description</b>   | cast plate ø 260mm   |                 |                     |
| <b>For models:</b>   | CG-110, CG7-10, CG7-11, CG9-05AD, CG9-05PLUS, CG9-10, CG9-10AD, CG9-10PLUS, CG9-11, CG-9110, CG9-11AD, CG9-11PLUS, CG9-31PLUS-D, CG9-31PLUS-I, CGE9-11, CGF9-120D, CGF9-120I, CGF9-121D, CGF9-121I |                 |                     |

|  |   |                 |                     |
|--|---|-----------------|---------------------|
| simmering plates   |   |                 |                     |
|  |   |                 |                     |
| 1  |   |                 |                     |
| <b>GEV No.</b>   | 109088  | <b>Ref. No.</b> | 12009018<br>U915414 |
| <b>description</b>   | simmer plate L 343mm W 310mm H 32mm for gas range |                 |                     |

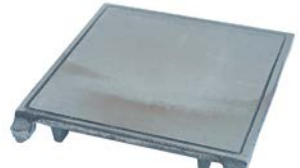
|  |   |                 |                     |
|--|---|-----------------|---------------------|
|  |   |                 |                     |
| 1  |   |                 |                     |
| <b>GEV No.</b>   | 109700  | <b>Ref. No.</b> | 12011961<br>U745411 |
| <b>description</b>   | simmer plate L 345mm W 310mm H 40mm                       |                 |                     |
| <b>For models:</b>   | CG7-20, CG7-40, CG7-41, CG7-61, CGB7-61, CGE7-41, CGE7-90 |                 |                     |

|  |   |                 |                     |
|--|---|-----------------|---------------------|
|  |   |                 |                     |
| 1  |   |                 |                     |
| <b>GEV No.</b>   | 109709  | <b>Ref. No.</b> | 12007699<br>U565406 |
| <b>description</b>   | simmer plate L 420mm W 345mm H 25mm   |                 |                     |
| <b>For models:</b>   | CG-1002, CG-1502, CG-2000, CG-2002, CG-2005, CG-210, CG-210G, CG-300S, CG-310, CG-310G, CG9-20, CG9-40, CG9-41, CG9-60, CG9-61, CG9-82, CGE9-41 |                 |                     |



accessories

pan supports



1

|                    |  |                 |                     |
|--------------------|--|-----------------|---------------------|
| <b>GEV No.</b>     | 109705   | <b>Ref. No.</b> | 12016228<br>U745415 |
| <b>description</b> | pan support W 310mm L 345mm H 50mm suitable for FAGOR black, varnished |                 |                     |
| <b>For models:</b> | CG7-20, CG7-40, CG7-41, CG7-61, CGB7-61, CGE7-41                       |                 |                     |



1

|                    |  |                 |                     |
|--------------------|--|-----------------|---------------------|
| <b>GEV No.</b>     | 109069   | <b>Ref. No.</b> | 12009419<br>U915413 |
| <b>description</b> | pan support W 310mm L 348mm H 54mm suitable for FAGOR cast iron  |                 |                     |
| <b>For models:</b> | CG7-20, CG7-20H, CG7-30D, CG7-30I, CG7-31D, CG7-31I, CG7-40, CG7-40H, CG7-41, CG7-41H, CG7-50, CG7-51, CG7-60, CG7-60H, CG7-61, CG7-61H, CGB7-61, CGB7-61H, CGB7-61R, CGB7-61RH, CGE7-41, CGE7-41H |                 |                     |



1

|                    |   |                 |                     |
|--------------------|---|-----------------|---------------------|
| <b>GEV No.</b>     | 109702  | <b>Ref. No.</b> | 12016262<br>U745413 |
| <b>description</b> | pan support W 310mm L 350mm suitable for FAGOR for burner cap ø 100mm |                 |                     |
| <b>For models:</b> | CG7-20, CG7-40, CG7-41, CG7-61, CGE7-88                               |                 |                     |



1

|                    |   |                 |                     |
|--------------------|---|-----------------|---------------------|
| <b>GEV No.</b>     | 109701  | <b>Ref. No.</b> | 12016263<br>U745412 |
| <b>description</b> | pan support W 310mm L 350mm suitable for FAGOR for burner cap ø 120mm |                 |                     |
| <b>For models:</b> | CG7-20, CG7-40, CG7-41, CG7-61, CGE7-89                               |                 |                     |

Зип Общепит

vsezip.ru

+7(812)987-08-81



1

|                    |   |                 |                     |
|--------------------|---|-----------------|---------------------|
| <b>GEV No.</b>     | 109716  | <b>Ref. No.</b> | 12007691<br>U565403 |
| <b>description</b> | pan support W 345mm L 425mm   |                 |                     |
| <b>For models:</b> | CG-1002, CG-1502, CG-2000, CG-2000-2P, CG-2002, CG-2005, CG-210, CG-210G, CG-300S, CG-310, CG-310G, CG9-20, CG9-40, CG9-41, CG9-51L, CG9-51LC, CG9-51R, CG9-51RC, CG9-60, CG9-61, CG9-82, CGE9-41 |                 |                     |

spillage trays

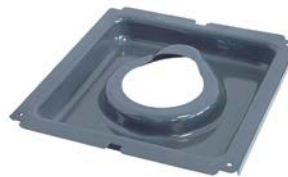

1

|                    |  |                 |                     |
|--------------------|--|-----------------|---------------------|
| <b>GEV No.</b>     | 109703   | <b>Ref. No.</b> | 12014294<br>U745416 |
| <b>description</b> | drain tray L 340mm W 310mm H 38mm ø 115mm for burner cap ø 100mm |                 |                     |
| <b>For models:</b> | CG7-20, CG7-40, CG7-41, CG7-61, CGB7-61, CGE7-41                 |                 |                     |

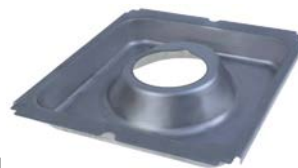

1

|                    |   |                 |                     |
|--------------------|---|-----------------|---------------------|
| <b>GEV No.</b>     | 109706  | <b>Ref. No.</b> | 12002032<br>U025404 |
| <b>description</b> | drain tray L 405mm W 348mm H 50mm for burner cap ø 100mm  |                 |                     |
| <b>For models:</b> | CG-1002, CG-1502, CG9-20, CG9-40, CG9-41, CG9-51L, CG9-51LC, CG9-51R, CG9-51RC, CG9-60, CG9-61, CG9-82, CGE9-41, CGF9-120D, CGF9-120I, CGF9-121D, CGF9-121I |                 |                     |



1

|                    |  |                 |                     |
|--------------------|--|-----------------|---------------------|
| <b>GEV No.</b>     | 109721   | <b>Ref. No.</b> | 12002033<br>U025405 |
| <b>description</b> | drain tray L 405mm W 348mm H 50mm for burner cap ø 120mm   |                 |                     |
| <b>For models:</b> | CG-1002, CG-1502, CG-2002, CG-2002P, CG9-20, CG9-40, CG9-41, CG9-51L, CG9-51LC, CG9-51R, CG9-51RC, CG9-60, CG9-61, CG9-82, CGE9-41, CGF9-120D, CGF9-120I, CGF9-121D, CGF9-121I |                 |                     |

1 gas components

Зип Общепит

vsezip.ru

+7(812)987-08-81



1

|                    |   |                 |   |
|--------------------|---|-----------------|---|
| <b>GEV No.</b>     | 109710  | <b>Ref. No.</b> | 12005899<br>12038914<br>12120850<br>U505408 |
| <b>description</b> | drain tray L 420mm W 344mm H 39mm ø 115mm for burner cap ø 100mm  |                 |   |
| <b>For models:</b> | CG-1002, CG-1502, CG-2005, CG-210, CG-210G, CG-300S, CG-310, CG-310G, CG9-20, CG9-40, CG9-41, CG9-51L, CG9-51LC, CG9-51R, CG9-51RC, CG9-60, CG9-61, CG9-82, CGE9-41 |                 |   |



1

|                    |   |                 |                     |
|--------------------|---|-----------------|---------------------|
| <b>GEV No.</b>     | 109709  | <b>Ref. No.</b> | 12007699<br>U565406 |
| <b>description</b> | simmer plate L 420mm W 345mm H 25mm   |                 |                     |
| <b>For models:</b> | CG-1002, CG-1502, CG-2000, CG-2002, CG-2005, CG-210, CG-210G, CG-300S, CG-310, CG-310G, CG9-20, CG9-40, CG9-41, CG9-60, CG9-61, CG9-82, CGE9-41 |                 |                     |



1

|                    |   |                 |                                 |
|--------------------|---|-----------------|---------------------------------|
| <b>GEV No.</b>     | 109711  | <b>Ref. No.</b> | 12005898<br>12038913<br>U505409 |
| <b>description</b> | drain tray L 420mm W 344mm H 45mm ø 140mm for burner cap ø 120mm  |                 |                                 |
| <b>For models:</b> | CG-1002, CG-1502, CG-2000, CG-2000-2P, CG-2002, CG-2005, CG-210, CG-210G, CG-300S, CG-310, CG-310G, CG9-20, CG9-40, CG9-41, CG9-51L, CG9-51LC, CG9-51R, CG9-51RC, CG9-60, CG9-61, CG9-82, CGE9-41 |                 |                                 |

air mixers



1

|                    |  |                 |                     |
|--------------------|--|-----------------|---------------------|
| <b>GEV No.</b>     | 109032   | <b>Ref. No.</b> | 12039944<br>X015705 |
| <b>description</b> | air mixing tube L 36mm ø 20mm                          |                 |                     |
| <b>For models:</b> | FG-71-15, FG-72-30, FG-91-20, FG-920, FG-92-40, FG-940 |                 |                     |

simmering plates



1

|                    |   |                 |                     |
|--------------------|---|-----------------|---------------------|
| <b>GEV No.</b>     | 109088  | <b>Ref. No.</b> | 12009018<br>U915414 |
| <b>description</b> | simmer plate L 343mm W 310mm H 32mm for gas range |                 |                     |



1

|                    |  |                 |                     |
|--------------------|--|-----------------|---------------------|
| <b>GEV No.</b>     | 109013   | <b>Ref. No.</b> | 12008047<br>U325707 |
| <b>description</b> | air mixing tube L 43mm ø 20mm  |                 |                     |
| <b>For models:</b> | BG6-05I, BG7-05, BG7-05I, BG7-10, BG7-10I, BG9-05, BG9-05AD, BG9-05I, BG9-05PF, BG9-05PI, BG9-05PLUS-I, BG9-10, BG9-10AD, BG9-10I, BG9-10PF, BG9-10PI, BG9-10PLUS-I, BMG7-10, BMG-9045, BMG9-05, BMG9-05V-T, BMG9-10, BMG9-10V-T, CG-1002, CG-1502, CG-2000, CG-2000-2P, CG-2002, CG-2002P, CG-210, CG-210G, CG-310, CG-310G, CG6-41, CG7-11, CG-7115, CG7-41, CG-7415, CG7-61, CG-7615, CG9-11, CG9-41, CG9-51L, CG9-51LC, CG9-51R, CG9-51RC, CG9-61, CG9-82, CGB7-61, CGB7-61H...(Other models you can see in the webshop) |                 |                     |



1

|                    |   |                 |                     |
|--------------------|---|-----------------|---------------------|
| <b>GEV No.</b>     | 109700  | <b>Ref. No.</b> | 12011961<br>U745411 |
| <b>description</b> | simmer plate L 345mm W 310mm H 40mm                       |                 |                     |
| <b>For models:</b> | CG7-20, CG7-40, CG7-41, CG7-61, CGB7-61, CGE7-41, CGE7-90 |                 |                     |



1

|                    |                               |                 |         |
|--------------------|-------------------------------|-----------------|---------|
| <b>GEV No.</b>     | 109036                        | <b>Ref. No.</b> | R425704 |
| <b>description</b> | air mixing tube L 43mm ø 20mm |                 |         |

bar burners

bar burners



1

|                    |   |                 |                     |
|--------------------|---|-----------------|---------------------|
| <b>GEV No.</b>     | 103029  | <b>Ref. No.</b> | 12007339<br>X285710 |
| <b>description</b> | bar burner 10-row L 600mm W 1150mm ømm H 65mm tilting bratt pan |                 |                     |
| <b>For models:</b> | SBG9-10, SBG9-10S, SBG9-15IM, SBG9-15IMS                        |                 |                     |







Зип Общепит

vsezip.ru



(812)987-08-81

|  |  |                 |                     |
|--|--|-----------------|---------------------|
|  <p>1</p> |  |                 |                     |
| <b>GEV No.</b>   | 109021   | <b>Ref. No.</b> | 12006607<br>R405700 |
| <b>description</b>   | bar burner 2 row L 490mm W 400mm ømm H 55mm bain marie |                 |                     |
| <b>For models:</b>   | BMG7-10, BMG-9045, BMG9-10, BMG9-10V-T                 |                 |                     |

|   |  |                 |                     |
|---|--|-----------------|---------------------|
|  <p>1</p> |  |                 |                     |
| <b>GEV No.</b>  | 105431   | <b>Ref. No.</b> | 12009503<br>T055703 |
| <b>description</b>  | bar burner 2 row L 540mm W 220mm ømm H 60mm chargrill  |                 |                     |
| <b>For models:</b>  | BG9-05, BG9-05AD, BG9-05I, BG9-05PF, BG9-05PI, BG9-05PLUS-I, BG9-10, BG9-10AD, BG9-10I, BG9-10PF, BG9-10PI, BG9-10PLUS-I |                 |                     |

|  |   |                 |                     |
|--|---|-----------------|---------------------|
|  <p>1</p> |   |                 |                     |
| <b>GEV No.</b>   | 109020  | <b>Ref. No.</b> | 12017305<br>T035700 |
| <b>description</b>   | bar burner 2 row L 530mm W 200mm ømm H 45mm chargrill |                 |                     |
| <b>For models:</b>   | BG7-05, BG7-05I, BG7-10, BG7-10I                      |                 |                     |

|   |  |                 |                     |
|---|--|-----------------|---------------------|
|  <p>1</p> |  |                 |                     |
| <b>GEV No.</b>  | 109030   | <b>Ref. No.</b> | 12007058<br>R635700 |
| <b>description</b>  | bar burner 2 row L 680mm W 238mm ømm H 110mm griddle   |                 |                     |
| <b>For models:</b>  | CG9-51L, CG9-51LC, CG9-51R, CG9-51RC, FTG-9050L, FTG-9050R, FTG9-05L, FTG9-05L-AD, FTG9-05LV-AD, FTG9-05PLUS-CL, FTG9-05PLUS-CR, FTG9-05PLUS-L, FTG9-05PLUS-LV, FTG9-05PLUS-R, FTG9-05PLUS-RV, FTG9-05R, FTG9-05R-AD, FTG9-05RV-AD, FTG9-05VL, FTG9-05VR, FTG-9100L, FTG-9100L+R, FTG-9100R, FTG9-10L, FTG9-10L+R, FTG9-10L+R-AD, FTG9-10L+RV-AD, FTG9-10L-AD, FTG9-10LV-AD, FTG9-10PLUS-CL, FTG9-10PLUS-CLR, FTG9-10PLUS-CR, FTG9-10PLUS-L, FTG9-10PLUS-LR, FTG9-10PLUS-LRV, FTG9-10PLUS-LV, FTG9-10PLUS-R, FTG9-10PLUS-RV, FTG9-10R, FTG9-10R-AD, FTG9-10RV-AD, FTG9-10VL, FTG9-10VL+R, FTG9-10VR, FTG9-11L, FTG9-11L+R, FTG9-11R, FTGC9-05, FTGC9-05L, FTGC9-05L-AD...(Other models you can see in the webshop) |                 |                     |

|  |   |                 |  |
|--|---|-----------------|--|
|  <p>1</p> |   |                 |  |
| <b>GEV No.</b>   | 109099  | <b>Ref. No.</b> | 12009491<br>12009491+2x12011165<br>T035702 |
| <b>description</b>   | bar burner 2 row L 530mm W 200mm ømm H 57mm chargrill |                 |  |
| <b>For models:</b>   | BG6-05I, BG7-05, BG7-05I, BG7-10, BG7-10I             |                 |  |
| <b>spare parts for</b>   | 109099  |                 |  |
|         |   |                 |  |
| <b>GEV No.</b>   | 691853  | <b>Ref. No.</b> | 12011165<br>T035473                        |
| bracket L 480mm H 45mm W 20mm  |   |                 |  |

|   |                                |                 |         |
|---|--------------------------------|-----------------|---------|
|  <p>1</p> |                                |                 |         |
| <b>GEV No.</b>  | 109033                         | <b>Ref. No.</b> | T055700 |
| <b>description</b>  | bar burner 2 row ømm chargrill |                 |         |

|  |   |                 |                     |
|--|---|-----------------|---------------------|
|  <p>1</p> |   |                 |                     |
| <b>GEV No.</b>   | 109053  | <b>Ref. No.</b> | 12017260<br>T035701 |
| <b>description</b>   | bar burner 2 row L 530mm W 200mm ømm H 75mm chargrill |                 |                     |

|   |                                  |                 |                     |
|---|----------------------------------|-----------------|---------------------|
|  <p>1</p> |                                  |                 |                     |
| <b>GEV No.</b>  | 109034                           | <b>Ref. No.</b> | 12017234<br>T055701 |
| <b>description</b>  | bar burner 2 row ømm chargrill   |                 |                     |
| <b>For models:</b>  | BG9-05, BG9-05I, BG9-10, BG9-10I |                 |                     |

1 gas components

Зип Общепит

vsezip.ru

+7(812)987-08-81



1

|                    |   |                 |         |
|--------------------|---|-----------------|---------|
| <b>GEV No.</b>     | 109037                                      | <b>Ref. No.</b> | S035700 |
| <b>description</b> | bar burner 4 row L 450mm W 420mm ømm kettle |                 |         |



1

|                    |  |                 |         |
|--------------------|--|-----------------|---------|
| <b>GEV No.</b>     | 109039   | <b>Ref. No.</b> | S275700 |
| <b>description</b> | bar burner 4 row L 590mm W 248mm ømm H 80mm kettle |                 |         |



1

|                    |   |                 |                     |
|--------------------|---|-----------------|---------------------|
| <b>GEV No.</b>     | 109038  | <b>Ref. No.</b> | 12012385<br>S275705 |
| <b>description</b> | bar burner 4 row L 595mm W 420mm ømm H 80mm 17.8kW kettle   |                 |                     |
| <b>For models:</b> | MG9-10, MG9-10BM, MG9-10BMS, MG9-10S, MG9-15, MG9-15BM, MG9-15BM316, MG9-15BMS, MG9-15S, MG9-20, MG9-20S, MPG9-10, MPG9-10BM, MPG9-10BMS, MPG9-10S, MPG9-15, MPG9-15BM, MPG9-15BMS, MPG9-15S, MPG9-20, MPG9-20S |                 |                     |



1

|                    |   |                 |                     |
|--------------------|---|-----------------|---------------------|
| <b>GEV No.</b>     | 109012  | <b>Ref. No.</b> | 12006166<br>U855702 |
| <b>description</b> | bar burner angled L 325mm W 355mm ømm Hmm gas range |                 |                     |
| <b>For models:</b> | CG-1502   |                 |                     |



1

|                    |   |                 |                     |
|--------------------|---|-----------------|---------------------|
| <b>GEV No.</b>     | 109008  | <b>Ref. No.</b> | 12013187<br>U745700 |
| <b>description</b> | bar burner angled L 570mm W 260mm ømm Hmm gas range   |                 |                     |
| <b>For models:</b> | CG7-11, CG7-41, CG7-61, CG9-11, CG9-41, CG9-51L, CG9-51LC, CG9-51R, CG9-51RC, CG9-61, CG9-82, CGF9-121D, CGF9-121I, FTG9-11L, FTG9-11L+R, FTG9-11R, FTGC9-11L, FTGC9-11L+R, FTGC9-11R, HG9-10, HG9-20 |                 |                     |



1

|                    |   |                 |                     |
|--------------------|---|-----------------|---------------------|
| <b>GEV No.</b>     | 109009  | <b>Ref. No.</b> | 12039902<br>U329201 |
| <b>description</b> | bar burner angled L 660mm W 260mm ømm Hmm gas range |                 |                     |



1

|                    |   |                 |                     |
|--------------------|---|-----------------|---------------------|
| <b>GEV No.</b>     | 109011  | <b>Ref. No.</b> | 12006629<br>U855700 |
| <b>description</b> | bar burner angled L 700mm W 320mm ømm Hmm gas range |                 |                     |



1

|                    |   |                 |                     |
|--------------------|---|-----------------|---------------------|
| <b>GEV No.</b>     | 109010  | <b>Ref. No.</b> | 12006657<br>U705700 |
| <b>description</b> | bar burner angled L 745mm W 260mm ømm Hmm gas range |                 |                     |
| <b>For models:</b> | CG-2000, CG-2000-2P, CG-2002, CG-2002P              |                 |                     |



1

|                    |  |                 |                     |
|--------------------|--|-----------------|---------------------|
| <b>GEV No.</b>     | 109187   | <b>Ref. No.</b> | 12024674<br>Z955801 |
| <b>description</b> | bar burner multiple L 180mm W 270mm ømm H 45mm flange support combi-steamer zinc-plated FAGOR  |                 |                     |
| <b>For models:</b> | GA-20, GA-20D, GA-40, GA-40D, HGP-10-21, HGP-20-21, HGV-10-11, HGV-10-21, HGV-20-11, HGV-20-21, HVG-10-11, HVG-10-11UL, HVG-10-21, HVG-10-21UL, HVG-20-11, HVG-20-21, HVG-2-10-11, HVG-2-20-21, MFHVG-10-11, MFHVG-10-21, VG-101, VG-102, VG-201, VG-202, VPG-101, VPG-102, VPG-201, VPG-202 |                 |                     |



1

|                    |   |                 |                      |
|--------------------|---|-----------------|----------------------|
| <b>GEV No.</b>     | 105920  | <b>Ref. No.</b> | 12030250<br>ICR10053 |
| <b>description</b> | bar burner ø 50mm Wmm Hmm L 450mm flange with bolt M4 flange width 65mm flange length 71mm kettle |                 |                      |



1

|                    |   |                 |                      |
|--------------------|---|-----------------|----------------------|
| <b>GEV No.</b>     | 105697  | <b>Ref. No.</b> | 12030251<br>ICR09485 |
| <b>description</b> | bar burner ø 50mm Wmm Hmm L 450mm with bolt M5x12 flange width 65mm flange length 71mm kettle |                 |                      |





Зип Общепит

vsezip.ru

+7(812)987-08-81

|  |   |                 |         |
|--|---|-----------------|---------|
|  <p>1</p> |   |                 |         |
| <b>GEV No.</b>   | 109035  | <b>Ref. No.</b> | R495700 |
| <b>description</b>   | bar burner ømm W 38mm H 33mm L 405mm bain marie |                 |         |

|  |   |                 |                     |
|--|---|-----------------|---------------------|
|  <p>1</p> |   |                 |                     |
| <b>GEV No.</b>   | 109018  | <b>Ref. No.</b> | 12013487<br>R795700 |
| <b>description</b>   | bar burner U-shape L 500mm W 145mm ø 30mm Hmm griddle   |                 |                     |
| <b>For models:</b>   | FTG7-05, FTG7-05L, FTG7-05R, FTG7-05VL, FTG7-05VR, FTG7-10, FTG7-10L, FTG7-10L+R, FTG7-10R, FTG7-10VL, FTG7-10VL+R, FTG7-10VR, FTGC7-05L, FTGC7-10L |                 |                     |

|   |  |                 |  |
|---|--|-----------------|--|
|  <p>1</p> |  |                 |  |
| <b>GEV No.</b>  | 109188   | <b>Ref. No.</b> | 12017291<br>12024272<br>R735700<br>T115710 |
| <b>description</b>  | burner fabric ø 38mm Wmm Hmm L 170mm connection thread combi-steamer SS  |                 |  |
| <b>For models:</b>  | COG-101, COG-102, HCG-10-11, HCG-10-21, HCG-2-10-11, HGC-10-11, HGC-10-21, HGP-10-21, HGV-10-11, HGV-10-21, HMG-10-21, HMG-10-21UL, HMG-2-10-11, HVG-10-11, HVG-10-11UL, HVG-10-21, HVG-10-21UL, HVG-2-10-11, MFHVG-10-11, MFHVG-10-21, VG-101, VG-102, VPG-101, VPG-102 |                 |  |

|  |                                       |                 |                     |
|--|---------------------------------------|-----------------|---------------------|
|  <p>1</p> |                                       |                 |                     |
| <b>GEV No.</b>   | 211047                                | <b>Ref. No.</b> | 12009424<br>T035464 |
| <b>description</b>   | chargrill grid L 508mm W 339mm H 22mm |                 |                     |
| <b>For models:</b>   | BG7-05, BG7-10                        |                 |                     |

|  |   |                 |                                |
|--|---|-----------------|--------------------------------|
|  <p>1</p> |   |                 |                                |
| <b>GEV No.</b>   | 211007  | <b>Ref. No.</b> | 12016512<br>T035455<br>T035481 |
| <b>description</b>   | chargrill grid L 570mm W 345mm H 75mm stainless steel chargrill |                 |                                |
| <b>For models:</b>   | BG7-05I, BG7-10I  |                 |                                |

|  |  |                 |                                 |
|--|--|-----------------|---------------------------------|
|  |  |                 |                                 |
| <b>GEV No.</b>   | 211046   | <b>Ref. No.</b> | 12009442<br>12016227<br>T055413 |
| <b>description</b>   | chargrill grid L 580mm W 410mm H 25mm chargrill      |                 |                                 |
| <b>For models:</b>   | BG9-05, BG9-05I, BG9-05PF, BG9-10, BG9-10I, BG9-10PF |                 |                                 |

|   |  |                 |                     |
|---|--|-----------------|---------------------|
|  <p>1</p> |  |                 |                     |
| <b>GEV No.</b>  | 109708   | <b>Ref. No.</b> | 12008843<br>T035425 |
| <b>description</b>  | chargrill grid L 585mm W 323mm H 40mm chargrill meat |                 |                     |
| <b>For models:</b>  | BG7-05, BG7-10                                       |                 |                     |

|   |   |                 |  |
|---|---|-----------------|--|
|  <p>1</p> |   |                 |  |
| <b>GEV No.</b>  | 211045  | <b>Ref. No.</b> | 12016527<br>12040319<br>T055452<br>T055462 |
| <b>description</b>  | chargrill grid L 655mm W 411mm H 70mm stainless steel chargrill |                 |  |
| <b>For models:</b>  | BG9-05, BG9-05I, BG9-10, BG9-10I                                |                 |  |

|   |   |                 |                     |
|---|---|-----------------|---------------------|
|  <p>1</p> |   |                 |                     |
| <b>GEV No.</b>  | 109715                                    | <b>Ref. No.</b> | 12008240<br>T055439 |
| <b>description</b>  | grid handle L 180mm ø 16mm thread M10x1.5 |                 |                     |
| <b>For models:</b>  | BG9-05, BG9-05I, BG9-10, BG9-10I          |                 |                     |

|   |                                       |                 |                     |
|---|---------------------------------------|-----------------|---------------------|
|  <p>1</p> |                                       |                 |                     |
| <b>GEV No.</b>  | 109707                                | <b>Ref. No.</b> | 12011720<br>T035406 |
| <b>description</b>  | lava rock grid L 480mm W 290mm H 20mm |                 |                     |

1 gas components

Зип Общепит  
vsezip.ru  
81(2)987-08-81

|   |                                       |                 |                     |
|---|---------------------------------------|-----------------|---------------------|
|  |                                       |                 |                     |
| 1   |                                       |                 |                     |
| <b>GEV No.</b>  | 109067                                | <b>Ref. No.</b> | 12002411<br>H122605 |
| <b>description</b>  | lava rock grid L 485mm W 275mm H 40mm |                 |                     |
| <b>For models:</b>  | BG7-05, BG7-05I, BG7-10, BG7-10I      |                 |                     |

|  |  |                 |                     |
|--|--|-----------------|---------------------|
|  |  |                 |                     |
| 1  |  |                 |                     |
| <b>GEV No.</b>   | 109708   | <b>Ref. No.</b> | 12008843<br>T035425 |
| <b>description</b>   | chargrill grid L 585mm W 323mm H 40mm chargrill meat |                 |                     |
| <b>For models:</b>   | BG7-05, BG7-10                                       |                 |                     |

|   |  |                 |          |
|---|--|-----------------|----------|
|  |  |                 |          |
| 1   |  |                 |          |
| <b>GEV No.</b>  | 109090   | <b>Ref. No.</b> | 12002481 |
| <b>description</b>  | lava rock grid L 545mm W 330mm H 30mm SS   |                 |          |
| <b>For models:</b>  | BG9-05AD, BG9-05PF, BG9-05PI, BG9-05PLUS-I, BG9-10AD, BG9-10PF, BG9-10PI, BG9-10PLUS-I |                 |          |

|  |   |                 |  |
|--|---|-----------------|--|
|  |   |                 |  |
| 1  |   |                 |  |
| <b>GEV No.</b>   | 211045  | <b>Ref. No.</b> | 12016527<br>12040319<br>T055452<br>T055462 |
| <b>description</b>   | chargrill grid L 655mm W 411mm H 70mm stainless steel chargrill |                 |  |
| <b>For models:</b>   | BG9-05, BG9-05I, BG9-10, BG9-10I                                |                 |  |

|   |                                       |                 |                     |
|---|---------------------------------------|-----------------|---------------------|
|  |                                       |                 |                     |
| 1   |                                       |                 |                     |
| <b>GEV No.</b>  | 109714                                | <b>Ref. No.</b> | 12012897<br>T055405 |
| <b>description</b>  | lava rock grid L 555mm W 350mm H 20mm |                 |                     |
| <b>For models:</b>  | BG9-05, BG9-05I, BG9-10, BG9-10I      |                 |                     |

|  |                                       |                 |                     |
|--|---------------------------------------|-----------------|---------------------|
| <b>lava rock grids</b>   |                                       |                 |                     |
|  |                                       |                 |                     |
| 1  |                                       |                 |                     |
| <b>GEV No.</b>   | 109707                                | <b>Ref. No.</b> | 12011720<br>T035406 |
| <b>description</b>   | lava rock grid L 480mm W 290mm H 20mm |                 |                     |

|   |                                       |                 |                     |
|---|---------------------------------------|-----------------|---------------------|
| <b>chargrill grids</b>  |                                       |                 |                     |
|  |                                       |                 |                     |
| 1   |                                       |                 |                     |
| <b>GEV No.</b>  | 211047                                | <b>Ref. No.</b> | 12009424<br>T035464 |
| <b>description</b>  | chargrill grid L 508mm W 339mm H 22mm |                 |                     |
| <b>For models:</b>  | BG7-05, BG7-10                        |                 |                     |

|  |                                       |                 |                     |
|--|---------------------------------------|-----------------|---------------------|
|  |                                       |                 |                     |
| 1  |                                       |                 |                     |
| <b>GEV No.</b>   | 109067                                | <b>Ref. No.</b> | 12002411<br>H122605 |
| <b>description</b>   | lava rock grid L 485mm W 275mm H 40mm |                 |                     |
| <b>For models:</b>   | BG7-05, BG7-05I, BG7-10, BG7-10I      |                 |                     |

|   |   |                 |                                |
|---|---|-----------------|--------------------------------|
|  |   |                 |                                |
| 1   |   |                 |                                |
| <b>GEV No.</b>  | 211007  | <b>Ref. No.</b> | 12016512<br>T035455<br>T035481 |
| <b>description</b>  | chargrill grid L 570mm W 345mm H 75mm stainless steel chargrill |                 |                                |
| <b>For models:</b>  | BG7-05I, BG7-10I  |                 |                                |

|  |  |                 |          |
|--|--|-----------------|----------|
|  |  |                 |          |
| 1  |  |                 |          |
| <b>GEV No.</b>   | 109090   | <b>Ref. No.</b> | 12002481 |
| <b>description</b>   | lava rock grid L 545mm W 330mm H 30mm SS   |                 |          |
| <b>For models:</b>   | BG9-05AD, BG9-05PF, BG9-05PI, BG9-05PLUS-I, BG9-10AD, BG9-10PF, BG9-10PI, BG9-10PLUS-I |                 |          |

|   |  |                 |                                 |
|---|--|-----------------|---------------------------------|
|  |  |                 |                                 |
| 1   |  |                 |                                 |
| <b>GEV No.</b>  | 211046   | <b>Ref. No.</b> | 12009442<br>12016227<br>T055413 |
| <b>description</b>  | chargrill grid L 580mm W 410mm H 25mm chargrill      |                 |                                 |
| <b>For models:</b>  | BG9-05, BG9-05I, BG9-05PF, BG9-10, BG9-10I, BG9-10PF |                 |                                 |

|  |                                       |                 |                     |
|--|---------------------------------------|-----------------|---------------------|
|  |                                       |                 |                     |
| 1  |                                       |                 |                     |
| <b>GEV No.</b>   | 109714                                | <b>Ref. No.</b> | 12012897<br>T055405 |
| <b>description</b>   | lava rock grid L 555mm W 350mm H 20mm |                 |                     |
| <b>For models:</b>   | BG9-05, BG9-05I, BG9-10, BG9-10I      |                 |                     |



Зип-Общепит forced air burners

vsezip.ru

7(812)987-08-81

|   |  |                 |                       |
|---|--|-----------------|-----------------------|
|  |  |                 |                       |
| 1   |  |                 |                       |
| <b>GEV No.</b>  | 109184   | <b>Ref. No.</b> | 12034224<br>RT72000-8 |
| <b>description</b>  | insulation for burner $\varnothing$ 97.5mm ID $\varnothing$ 62.5mm thickness 9.5mm |                 |                       |

|   |   |                 |                     |
|---|---|-----------------|---------------------|
|  |   |                 |                     |
| 1   |   |                 |                     |
| <b>GEV No.</b>  | 109022  | <b>Ref. No.</b> | 12016252<br>S135733 |
| <b>description</b>  | venturi L 150mm   |                 |                     |
| <b>For models:</b>  | HPG-35, MG7-10, MG7-10BM, MG9-10, MG-9100, MG9-10BM, MG9-10BMS, MG9-10S, MG9-15, MG-9150, MG-9150BM, MG9-15BM, MG9-15BM316, MG9-15BMS, MG9-15S, MG9-20, MG-9200, MG9-20S, MPG9-10, MPG9-10BM, MPG9-10BMS, MPG9-10S, MPG9-15, MPG-9150, MPG9-15BM, MPG9-15BMS, MPG9-15S, MPG9-20, MPG-9200, MPG9-20S |                 |                     |

|  |                                     |                 |                     |
|--|-------------------------------------|-----------------|---------------------|
|  |                                     |                 |                     |
| 1  |                                     |                 |                     |
| <b>GEV No.</b>   | 109070                              | <b>Ref. No.</b> | 12017311<br>T075709 |
| <b>description</b>   | burner L 118mm $\varnothing$ 30.6mm |                 |                     |
| <b>For models:</b>   | HCG-6-11, HMG-6-11                  |                 |                     |

|  |   |                 |                        |
|--|---|-----------------|------------------------|
|  |   |                 |                        |
| 1  |   |                 |                        |
| <b>GEV No.</b>   | 107930  | <b>Ref. No.</b> | 12039680<br>T955750000 |
| <b>description</b>   | burner L 250mm $\varnothing$ 38mm combi-steamer FAGOR |                 |                        |
| <b>For models:</b>   | ACG-061, AG-061, AG-061W, APG-061, APG-061W           |                 |                        |

tube burners

|  |   |                 |                     |
|--|---|-----------------|---------------------|
|  |   |                 |                     |
| 1  |   |                 |                     |
| <b>GEV No.</b>   | 109019  | <b>Ref. No.</b> | 12009433<br>X015700 |
| <b>description</b>   | tubular burner L 340mm W 61mm H 58mm oval   |                 |                     |
| <b>For models:</b>   | FG7-05-1C, FG7-05-2C, FG-710, FG7-10-2C, FG7-104C, FG7-10-4C, FG-71-15, FG-720, FG-72-30, FG9-05, FG9-05-1C, FG9-05-2C, FG9-05AD, FG9-05PLUS, FG9-05PLUS-S, FG9-05S, FG9-05S-1C, FG9-05S-2C, FG9-05S-AD, FG9-10, FG9-10-2C, FG9-10-4C, FG9-10AD, FG9-10PLUS, FG-91-20, FG-920, FG-92-40, FG-940 |                 |                     |

|   |  |                 |                        |
|---|--|-----------------|------------------------|
|  |  |                 |                        |
| 1   |  |                 |                        |
| <b>GEV No.</b>  | 107929   | <b>Ref. No.</b> | 12039583<br>T855750000 |
| <b>description</b>  | burner L 260mm $\varnothing$ 37.5mm for combi-steamer FAGOR            |                 |                        |
| <b>For models:</b>  | AG-061, AG-061W, AG-101, AG-101W, APG-061, APG-061W, APG-101, APG-101W |                 |                        |

round burners

|   |   |                 |                     |
|---|---|-----------------|---------------------|
|  |   |                 |                     |
| 1   |   |                 |                     |
| <b>GEV No.</b>  | 106963  | <b>Ref. No.</b> | 12009065<br>U875707 |
| <b>description</b>  | round burner $\varnothing$ 410mm L 590mm H 100mm D1 $\varnothing$ 220mm |                 |                     |
| <b>For models:</b>  | CGP9-10, CGP9-11  |                 |                     |

|  |   |                 |                        |
|--|---|-----------------|------------------------|
|  |   |                 |                        |
| 1  |   |                 |                        |
| <b>GEV No.</b>   | 107927  | <b>Ref. No.</b> | 12039556<br>T845750000 |
| <b>description</b>   | burner L 270mm $\varnothing$ 38mm for combi-steamer                   |                 |                        |
| <b>For models:</b>   | ACG-101, ACG-201, AG-101, AG-101W, AG-201, APG-101, APG-101W, APG-201 |                 |                        |

1 gas components

Зип Общепит  
vsezip.ru  
(812) 987-08-81



|                    |   |                 |                        |
|--------------------|---|-----------------|------------------------|
| <b>GEV No.</b>     | 107925  | <b>Ref. No.</b> | 12039442<br>T645739000 |
| <b>description</b> | burner L 300mm ø 44mm for combi-steamer FAGOR                         |                 |                        |
| <b>For models:</b> | ACG-102, ACG-202, AG-102, AG-102W, AG-202, APG-102, APG-102W, APG-202 |                 |                        |



|                    |   |                 |          |
|--------------------|---|-----------------|----------|
| <b>GEV No.</b>     | 107899  | <b>Ref. No.</b> | 12044424 |
| <b>description</b> | burner L 435mm ø 52mm for combi-steamer FAGOR |                 |          |
| <b>For models:</b> | AG-201, APG-201                               |                 |          |



|                    |   |                 |                     |
|--------------------|---|-----------------|---------------------|
| <b>GEV No.</b>     | 101190  | <b>Ref. No.</b> | 12022913<br>T015700 |
| <b>description</b> | burner chamber L 190mm ø 150mm                        |                 |                     |
| <b>For models:</b> | COG-101, HCG-10-11, HCG-10-21, HCG-2-10-11, HGC-10-11 |                 |                     |

accessories

covers



|                    |   |                 |                     |
|--------------------|---|-----------------|---------------------|
| <b>GEV No.</b>     | 104211  | <b>Ref. No.</b> | 12013981<br>U745705 |
| <b>description</b> | cover L 550mm W 155mm H 24mm SS for burner  |                 |                     |
| <b>For models:</b> | CG7-11, CG7-41, CG7-61, CG9-11, CG9-41, CG9-51L, CG9-51LC, CG9-51R, CG9-51RC, CG9-61, CG9-82, CGF9-121D, CGF9-121I, FTG9-11L, FTG9-11L+R, FTG9-11R, FTGC9-11L, FTGC9-11L+R, FTGC9-11R, HG9-10, HG9-20 |                 |                     |



|                    |  |                 |                        |
|--------------------|--|-----------------|------------------------|
| <b>GEV No.</b>     | 104796   | <b>Ref. No.</b> | 12004960<br>U915703000 |
| <b>description</b> | cover ø 180mm thickness 2mm hole ø 118mm stainless steel for gas range suitable for FAGOR  |                 |                        |
| <b>For models:</b> | CG7-20H, CG7-30D, CG7-30I, CG7-31D, CG7-31I, CG7-40, CG7-40H, CG7-41, CG7-41H, CG7-50, CG7-51, CG7-60, CG7-60H, CG7-61, CG7-61H, CG9-20, CG9-20AD, CG9-20AD-H, CG9-20H, CG9-20PLUS, CG9-20PLUS-H, CG9-31PLUS-D, CG9-31PLUS-I, CG9-40, CG9-40AD, CG9-40AD-H, CG9-40H, CG9-40PLUS, CG9-40PLUS-H, CG9-41, CG9-41AD, CG9-41AD-H, CG9-41H, CG9-41PLUS, CG9-41PLUS-H, CG9-51L, CG9-51LC, CG9-51R, CG9-51RC, CG9-60, CG9-60AD, CG9-60AD-H, CG9-60H, CG9-60PLUS, CG9-60PLUS-H, CG9-61, CG9-61AD, CG9-61AD-H, CG9-61H, CG9-61OP...(Other models you can see in the webshop) |                 |                        |

gaskets



|                    |  |                 |                     |
|--------------------|--|-----------------|---------------------|
| <b>GEV No.</b>     | 109044   | <b>Ref. No.</b> | 12023733<br>T075013 |
| <b>description</b> | gasket D1 ø 102mm D2 ø 71mm thickness 3.3mm graphite |                 |                     |
| <b>For models:</b> | COG-061, HCG-6-11, HGC-6-11, HMG-6-11                |                 |                     |



|                    |  |                 |                     |
|--------------------|--|-----------------|---------------------|
| <b>GEV No.</b>     | 109045   | <b>Ref. No.</b> | 12023765<br>R725055 |
| <b>description</b> | gasket D1 ø 130mm D2 ø 95mm thickness 3.3mm graphite   |                 |                     |
| <b>For models:</b> | COG-101, COG-102, COG-201, COG-202, HCG-10-11, HCG-10-21, HCG-20-11, HCG-20-21, HCG-2-10-11, HCG-2-20-11, HGC-10-11, HGC-10-21, HGC-20-11, HGC-20-21, HGP-10-21, HGP-20-21, HGV-10-11, HGV-10-21, HGV-20-11, HGV-20-21, HMG-10-11, HMG-10-11UL, HMG-10-21, HMG-10-21UL, HMG-20-11, HMG-2-10-11, HVG-10-11, HVG-10-11UL, HVG-10-21, HVG-10-21UL, HVG-20-11, HVG-20-21, HVG-2-10-11, HVG-2-20-21, MFHVG-10-11, MFHVG-10-21, VG-101, VG-102, VG-201, VG-202, VPG-101, VPG-102, VPG-201, VPG-202 |                 |                     |



|                    |   |                 |                     |
|--------------------|---|-----------------|---------------------|
| <b>GEV No.</b>     | 109046  | <b>Ref. No.</b> | 12023994<br>T075014 |
| <b>description</b> | gasket D1 ø 168mm D2 ø 132mm thickness 3.3mm graphite |                 |                     |
| <b>For models:</b> | COG-061, HCG-6-11, HGC-6-11, HMG-6-11                 |                 |                     |





Зип Общепит

vsezip.ru

7(812)98770881

|  |  |                 |                     |
|--|--|-----------------|---------------------|
|  <p>1</p> |  |                 |                     |
| <b>GEV No.</b>   | 109047   | <b>Ref. No.</b> | 12023991<br>R725051 |
| <b>description</b>   | gasket D1 ø 200mm D2 ø 153mm thickness 3.3mm graphite  |                 |                     |
| <b>For models:</b>   | COG-101, COG-102, HCG-10-11, HCG-10-21, HCG-20-11, HCG-2-10-11, HCG-10-11, HCG-10-21, HGP-10-21, HGV-10-11, HGV-10-21, HMG-10-11, HMG-10-11UL, HMG-10-21, HMG-10-21UL, HMG-20-11, HMG-2-10-11, HVG-10-11, HVG-10-11UL, HVG-10-21, HVG-10-21UL, HVG-2-10-11, MFHVG-10-11, MFHVG-10-21, VG-101, VG-102, VPG-101, VPG-102 |                 |                     |

|   |  |                 |                     |
|---|--|-----------------|---------------------|
|  <p>1</p> |  |                 |                     |
| <b>GEV No.</b>  | 510128   | <b>Ref. No.</b> | 12017015<br>R725011 |
| <b>description</b>  | gasket L 71mm W 46mm H 2mm hole ø 28mm hole distance 55mm rubber oval for gas burner   |                 |                     |
| <b>For models:</b>  | HCG-10-11, HCG-10-21, HCG-20-11, HCG-2-10-11, HCG-6-11, HMG-10-11, HMG-10-11UL, HMG-10-21, HMG-10-21UL, HMG-20-11, HMG-2-10-11, HMG-6-11 |                 |                     |

|  |                                    |                 |                        |
|--|------------------------------------|-----------------|------------------------|
|  <p>2</p> |                                    |                 |                        |
| <b>GEV No.</b>   | 104283                             | <b>Ref. No.</b> | 12035017<br>RT51101318 |
| <b>description</b>   | gasket L 100mm W 100mm hole ø 64mm |                 |                        |

|   |   |                 |                                 |
|---|---|-----------------|---------------------------------|
| <p>nozzle holders</p>  <p>1</p> |   |                 |                                 |
| <b>GEV No.</b>  | 109058  | <b>Ref. No.</b> | 12013850<br>12018677<br>R155012 |
| <b>description</b>  | nozzle holder nozzle M10x1 3/8" screw pipe fitting 3/8" with pipe tube ø 10mm |                 |                                 |
| <b>For models:</b>  | FTG9-05L, FTG9-05R, FTGC9-05L, FTGC9-05R                                      |                 |                                 |

|  |   |                 |                     |
|--|---|-----------------|---------------------|
|  <p>1</p> |   |                 |                     |
| <b>GEV No.</b>   | 109048  | <b>Ref. No.</b> | 12024476<br>R725052 |
| <b>description</b>   | gasket L 110mm W 110mm H 3.3mm hole ø 81mm graphite   |                 |                     |
| <b>For models:</b>   | HGV-10-11, HMG-10-11, HMG-10-11UL, HMG-10-21, HMG-10-21UL, HMG-20-11, HMG-2-10-11, HVG-10-11, HVG-10-11UL, HVG-10-21, HVG-10-21UL, HVG-2-10-11, MFHVG-10-11, MFHVG-10-21, VG-101, VPG-101 |                 |                     |

|   |  |                 |                     |
|---|--|-----------------|---------------------|
| <p>miscellaneous</p>  <p>1</p> |  |                 |                     |
| <b>GEV No.</b>  | 109043                                   | <b>Ref. No.</b> | 12015347<br>T035472 |
| <b>description</b>  | bracket for burner L 480mm W 62mm H 20mm |                 |                     |
| <b>For models:</b>  | BG9-05, BG9-05L, BG9-10, BG9-10L         |                 |                     |

|  |  |                 |                     |
|--|--|-----------------|---------------------|
|  <p>1</p> |  |                 |                     |
| <b>GEV No.</b>   | 510125   | <b>Ref. No.</b> | 12021217<br>R725009 |
| <b>description</b>   | gasket L 62mm W 42mm H 3mm hole ø 24mm hole distance 49mm graphite oval for gas burner                             |                 |                     |
| <b>For models:</b>   | HCG-10-11, HCG-10-21, HCG-2-10-11, HCG-6-11, HMG-10-11, HMG-10-11UL, HMG-10-21, HMG-10-21UL, HMG-2-10-11, HMG-6-11 |                 |                     |

|   |   |                 |                     |
|---|---|-----------------|---------------------|
|  <p>1</p> |   |                 |                     |
| <b>GEV No.</b>  | 104147                                      | <b>Ref. No.</b> | 12022614<br>T075708 |
| <b>description</b>  | flange ø 167mm thickness 1.6mm hole ø 9.6mm |                 |                     |
| <b>For models:</b>  | HCG-6-11, HMG-6-11                          |                 |                     |

|  |   |                 |                     |
|--|---|-----------------|---------------------|
|  <p>1</p> |   |                 |                     |
| <b>GEV No.</b>   | 105583  | <b>Ref. No.</b> | 12020725<br>T075015 |
| <b>description</b>   | gasket L 70mm W 70mm thickness 3.5mm hole ø 51mm graphite |                 |                     |
| <b>For models:</b>   | HMG-6-11  |                 |                     |

1 gas components

## gas nozzles

## main nozzles

## gas nozzles M6x0.75



|                    |   |                 |                     |
|--------------------|---|-----------------|---------------------|
| <b>GEV No.</b>     | 106482  | <b>Ref. No.</b> | 12023498<br>Z956104 |
| <b>description</b> | gas injector thread M6x0.75 WS 7 bore ø 1.1mm   |                 |                     |
| <b>For models:</b> | GA-20, GA-20D, GA-40, GA-40D, HGP-10-21, HGP-20-21, HGV-10-11, HGV-10-21, HGV-20-21, HVG-10-11, HVG-10-21, HVG-20-11, HVG-20-21, HVG-2-10-11, HVG-2-20-21, VG-101, VG-102, VG-201, VG-202, VPG-101, VPG-102, VPG-201, VPG-202 |                 |                     |



|                    |  |                 |                     |
|--------------------|--|-----------------|---------------------|
| <b>GEV No.</b>     | 109414   | <b>Ref. No.</b> | 12024100<br>Z956108 |
| <b>description</b> | gas injector thread M6x0.75 WS 7 bore ø 2.25mm |                 |                     |
| <b>For models:</b> | GA-20, GA-20D, GA-40, GA-40D                   |                 |                     |

## gas nozzles M10x1



|                    |  |                 |                     |
|--------------------|--|-----------------|---------------------|
| <b>GEV No.</b>     | 109410                                       | <b>Ref. No.</b> | 12008787<br>U322401 |
| <b>description</b> | gas injector thread M10x1 WS 13 bore ø 0.8mm |                 |                     |
| <b>For models:</b> | BMG9-05, BMG9-05V-T                          |                 |                     |



|                    |  |                 |                     |
|--------------------|--|-----------------|---------------------|
| <b>GEV No.</b>     | 109415   | <b>Ref. No.</b> | 12008802<br>U122407 |
| <b>description</b> | gas injector thread M10x1 WS 13 bore ø 1.05mm  |                 |                     |
| <b>For models:</b> | CG-1002, CG-1502, CG-2000, CG-2002, CG-2002P, CG-2005, CG-210, CG-210G, CG-300S, CG-310, CG-310G, CG7-20, CG-7200, CG7-30D, CG7-30I, CG7-31D, CG7-31I, CG7-40, CG-7400, CG7-41, CG-7415, CG7-50, CG7-51, CG7-60, CG7-61, CG-7615, CG9-05AD, CG9-05PLUS, CG9-20, CG9-20AD, CG9-20H, CG9-20PLUS, CG9-31PLUS-D, CG9-31PLUS-I, CG9-40, CG9-40AD, CG9-40H, CG9-40PLUS, CG9-41, CG9-41AD, CG9-41H, CG9-41PLUS, CG9-51L, CG9-51LC, CG9-51R, CG9-51RC, CG9-60, CG9-60AD, CG9-60H, CG9-60PLUS...(Other models you can see in the webshop) |                 |                     |



|                    |  |                 |                     |
|--------------------|--|-----------------|---------------------|
| <b>GEV No.</b>     | 109416   | <b>Ref. No.</b> | 12008800<br>X312400 |
| <b>description</b> | gas injector thread M10x1 WS 13 bore ø 1.1mm   |                 |                     |
| <b>For models:</b> | CG-1502, CG6-41, CG7-20, CG7-30D, CG7-30I, CG7-31D, CG7-31I, CG7-40, CG7-41, CG7-50, CG7-51, CG7-60, CG7-61, CG9-20, CG9-20H, CG9-40, CG9-40H, CG9-41, CG9-41H, CG9-51L, CG9-51LC, CG9-51R, CG9-51RC, CG9-60, CG9-60H, CG9-61, CG9-61H, CG9-61OP, CG9-82, CGB7-61, CGB7-61R, CGE7-41, CGE9-41, CGF9-120D, CGF9-120I, CGF9-121D, CGF9-121I, CGP9-10, CGP9-11, CPG7-05, CPG7-05NC, FG7-05-1C, FG7-05-2C, FG-710, FG7-10-2C, FG7-104C, FG7-10-4C, FG-720, GPC-350 |                 |                     |



|                    |  |                 |  |
|--------------------|--|-----------------|--|
| <b>GEV No.</b>     | 109419   | <b>Ref. No.</b> | 12008939<br>12039112<br>R422400<br>X162403 |
| <b>description</b> | gas injector thread M10x1 WS 13 bore ø 1.25mm  |                 |  |
| <b>For models:</b> | BMG7-10, BMG9-10, BMG9-10V-T, CG-200S, CG-210, CG-210G, CG-300S, CG-310, CG-310G, CG7-11, CG7-20H, CG7-30D, CG7-30I, CG7-31D, CG7-31I, CG7-40, CG7-40H, CG7-41, CG7-41H, CG7-50, CG7-51, CG7-60, CG7-60H, CG7-61, CG7-61H, CGB7-61, CGB7-61H, CGB7-61R, CGB7-61RH, CGE7-104, CGE7-41, CGE7-41H, FG9-05, FG9-05-1C, FG9-05-2C, FG9-05AD, FG9-05PLUS, FG9-05PLUS-S, FG9-05S, FG9-05S-1C, FG9-05S-2C, FG9-05S-AD, FG9-10, FG9-10-2C, FG9-10-4C, FG9-10AD, FG9-10PLUS, FTG7-05, FTG7-05L, FTG7-05R...(Other models you can see in the webshop) |                 |  |



|                    |   |                 |                     |
|--------------------|---|-----------------|---------------------|
| <b>GEV No.</b>     | 109418  | <b>Ref. No.</b> | 12008806<br>9271300 |
| <b>description</b> | gas injector thread M10x1 WS 13 bore ø 1.2mm  |                 |                     |
| <b>For models:</b> | BMG9-05, BMG9-05V-T, CG-7415, CG-7615, FG-710, FG-720, FTE7-05, FTE7-10, FTG7-05, FTG7-10, FTGC7-05L, FTGC7-10L |                 |                     |



|                    |  |                 |  |
|--------------------|--|-----------------|--|
| <b>GEV No.</b>     | 109421   | <b>Ref. No.</b> | 12008809<br>12019845<br>12020928<br>R612400<br>X162400 |
| <b>description</b> | gas injector thread M10x1 WS 13 bore ø 1.35mm  |                 |  |
| <b>For models:</b> | BG7-05, BG7-05I, BG7-10, BG7-10I, CG7-31D, CG7-31I, CG7-41, CG7-41H, CG7-51, CG7-61, CG7-61H, CGB7-61, CGB7-61H, CGB7-61R, CGB7-61RH, CGP9-11, FG6-05, FG6-10, FG-920, FG-940, FTG6-10VL, FTG6-10VL+R, FTG6-10VR, FTGC6-10L, FTGC6-10L+R, SBG9-10I-AD, SBG9-10I-AD-S, SBG9-10IIM-AD, SBG9-10IIM-AD-S, SBG9-15IM-AD, SBG9-15IM-AD-S |                 |  |







Зип Общепит

vsezip.ru

+7(812)987-08-81

|   |  |                 |                     |
|---|--|-----------------|---------------------|
|  |  |                 |                     |
| 1   |  |                 |                     |
| <b>GEV No.</b>  | 109420   | <b>Ref. No.</b> | 12008770<br>U052402 |
| <b>description</b>  | gas injector thread M10x1 WS 13 bore ø 1.3mm   |                 |                     |
| <b>For models:</b>  | BG6-05I, BMG-9045, CG-200S, CG-210, CG-210G, CG-300S, CG-310, CG-310G, CG-7200, CG-7400, CG-7415, CG-7615, FTG-7050L, FTG-7050R, FTG7-05L, FTG7-05R, FTG7-05VL, FTG7-05VR, FTG-7100L, FTG-7100L+R, FTG-7100R, FTG7-10L, FTG7-10L+R, FTG7-10R, FTG7-10VL, FTG7-10VL+R, FTG7-10VR, FTGC7-05L, FTGC7-10L, SBG7-10 |                 |                     |

|  |   |                 |                     |
|--|---|-----------------|---------------------|
|  |   |                 |                     |
| 1  |   |                 |                     |
| <b>GEV No.</b>   | 109424  | <b>Ref. No.</b> | 12009579<br>9105100 |
| <b>description</b>   | gas injector thread M10x1 WS 13 bore ø 1.5mm  |                 |                     |
| <b>For models:</b>   | CG-1002, CG-1502, CG-2000, CG-2002, CG-2002P, CG-200S, CG-210, CG-210G, CG-300S, CG-310, CG-310G, CG7-20, CG7-40, CG7-41, CG7-61, CG9-11, CG9-20, CG9-40, CG9-41, CG9-51L, CG9-51RC, CG9-51R, CG9-51RC, CG9-60, CG9-61, CG9-82, CGB7-61, CGE7-111, CGE7-41, CGE9-41, CGF9-120D, CGF9-120I, CGF9-121D, CGF9-121I, CG-HP-20, CGP9-10, CGP9-11, FI-5420, FI-7630, FTG9-05L, FTG9-05L-AD, FTG9-05LV-AD, FTG9-05PLUS-CL, FTG9-05PLUS-CR, FTG9-05PLUS-L, FTG9-05PLUS-LV, FTG9-05PLUS-R, FTG9-05PLUS-RV, FTG9-05R, FTG9-05R-AD...(Other models you can see in the webshop) |                 |                     |

|   |   |                 |                     |
|---|---|-----------------|---------------------|
|  |   |                 |                     |
| 1   |   |                 |                     |
| <b>GEV No.</b>  | 109423  | <b>Ref. No.</b> | 12008796<br>U052401 |
| <b>description</b>  | gas injector thread M10x1 WS 13 bore ø 1.45mm   |                 |                     |
| <b>For models:</b>  | CG7-10, CG7-11, CG-7115, CG9-11, CG9-11AD, CG9-11PLUS, CG9-20H, CG9-31PLUS-D, CG9-31PLUS-I, CG9-40H, CG9-41, CG9-41AD, CG9-41AD-H, CG9-41H, CG9-41PLUS, CG9-41PLUS-H, CG9-51L, CG9-51LC, CG9-51R, CG9-51RC, CG9-60H, CG9-61, CG9-61AD, CG9-61AD-H, CG9-61H, CG9-61PLUS, CG9-61PLUS-H, CG9-82, CG9-82AD, CG9-82PLUS, CGF9-121D, CGF9-121D-AD, CGF9-121I, CGF9-121I-AD, CGF9-121PLUS-D, CGF9-121PLUS-I, CPG9-05, CPG9-05AD, CPG9-05AD-S, CPG9-05NC, CPG9-05PLUS, CPG9-05PLUS-S, CPG9-05S, CPG9-05SNC, FTG6-05VL, FTG6-05VR, FTG9-05L, FTG9-05PLUS-CL, FTG9-05PLUS-CR, FTG9-05PLUS-L...(Other models you can see in the webshop) |                 |                     |

|  |   |                 |                     |
|--|---|-----------------|---------------------|
|  |   |                 |                     |
| 1  |   |                 |                     |
| <b>GEV No.</b>   | 109427  | <b>Ref. No.</b> | 12008793<br>R302400 |
| <b>description</b>   | gas injector thread M10x1 WS 13 bore ø 1.65mm   |                 |                     |
| <b>For models:</b>   | BG9-05, BG9-05AD, BG9-05I, BG9-05PF, BG9-05PI, BG9-05PLUS-I, BG9-10, BG9-10AD, BG9-10I, BG9-10PF, BG9-10PI, BG9-10PLUS-I, CG7-20, CG7-30D, CG7-30I, CG7-31D, CG7-31I, CG7-40, CG7-41, CG7-50, CG7-51, CG7-60, CG7-61, CG9-05AD, CG9-05PLUS, CG9-10, CG9-10AD, CG9-10PLUS, CG9-11, CG9-11AD, CG9-11PLUS, CG9-20, CG9-20AD, CG9-20H, CG9-20PLUS, CG9-31PLUS-D, CG9-31PLUS-I, CG9-40, CG9-40AD, CG9-40H, CG9-40PLUS, CG9-41, CG9-41AD, CG9-41H, CG9-41PLUS, CG9-51L, CG9-51LC, CG9-51R, CG9-51RC, CG9-60...(Other models you can see in the webshop) |                 |                     |

|   |   |                 |   |
|---|---|-----------------|---|
|  |   |                 |   |
| 1   |   |                 |   |
| <b>GEV No.</b>  | 109422  | <b>Ref. No.</b> | 12008805<br>631000<br>631000000<br>9631000<br>O631000 |
| <b>description</b>  | gas injector thread M10x1 WS 13 bore ø 1.4mm  |                 |   |
| <b>For models:</b>  | BG7-05, BG7-05I, BG7-10, BG7-10I, CG-1002, CG-1502, CG-2002, CG-2002P, CG9-20, CG9-20H, CG9-31PLUS-D, CG9-31PLUS-I, CG9-40, CG9-40H, CG9-41, CG9-41H, CG9-51L, CG9-51LC, CG9-51R, CG9-51RC, CG9-60, CG9-60H, CG9-61, CG9-61H, CG9-61OP, CG9-82, CGE9-41, CGF9-120D, CGF9-120I, CGF9-121D, CGF9-121I, HG9-15 |                 |   |

|  |   |                 |                     |
|--|---|-----------------|---------------------|
|  |   |                 |                     |
| 1  |   |                 |                     |
| <b>GEV No.</b>   | 109426  | <b>Ref. No.</b> | 12017204<br>X102401 |
| <b>description</b>   | gas injector thread M10x1 WS 13 bore ø 1.6mm  |                 |                     |
| <b>For models:</b>   | CG-2000-2P, FGCL9-05, FTG-9050L, FTG-9050R, FTG9-05L, FTG9-05R, FTG-9100L, FTG-9100L+R, FTG-9100R, FTG9-10L, FTG9-10L+R, FTG9-10R, FTGC9-05, FTGC-9050, FTGC9-10, FTGC-9100 |                 |                     |

|   |  |                 |                     |
|---|--|-----------------|---------------------|
|  |  |                 |                     |
| 1   |  |                 |                     |
| <b>GEV No.</b>  | 109425   | <b>Ref. No.</b> | 12008797<br>U112401 |
| <b>description</b>  | gas injector thread M10x1 WS 13 bore ø 1.55mm  |                 |                     |
| <b>For models:</b>  | BG9-05, BG9-05I, BG9-10, BG9-10I, CG-1002, CG-1502, CG-2002, CG-2002P, CG-200S, CG-210, CG-210G, CG-300S, CG-310, CG-310G, CG-7200, CG-7400, CG-7415, CG-7615, CG9-20AD-H, CG9-20H, CG9-20PLUS-H, CG9-40, CG9-40AD, CG9-40AD-H, CG9-40H, CG9-40PLUS, CG9-40PLUS-H, CG9-41, CG9-41AD, CG9-41AD-H, CG9-41H, CG9-41PLUS, CG9-41PLUS-H, CG9-51L, CG9-51LC, CG9-51R, CG9-51RC, CG9-60, CG9-60AD, CG9-60AD-H, CG9-60H, CG9-60PLUS, CG9-60PLUS-H, CG9-61, CG9-61AD, CG9-61AD-H, CG9-61H, CG9-61OP, CG9-61PLUS, CG9-61PLUS-H...(Other models you can see in the webshop) |                 |                     |

|  |  |                 |                     |
|--|--|-----------------|---------------------|
|  |  |                 |                     |
| 1  |  |                 |                     |
| <b>GEV No.</b>   | 109428   | <b>Ref. No.</b> | 12024249<br>N502401 |
| <b>description</b>   | gas injector thread M10x1 WS 13 bore ø 1.7mm   |                 |                     |
| <b>For models:</b>   | CG-1002, CG-1502, CG-2000, CG-2000-2P, CG-2002, CG-2002P, CG-210, CG-210G, CG-310, CG-310G, CG6-41, CG9-10, CG9-11, CG9-51L, CG9-51LC, CG9-51R, CG9-51RC, CGP9-10, CGP9-11, CPG7-05, CPG7-05NC, FG7-05-1C, FG7-05-2C, FG-710, FG7-10-2C, FG7-104C, FG7-10-4C, FG-720, FI-5420, FI-7630, FTG9-05L, FTG9-05R, FTG9-05VL, FTG9-05VR, FTG9-10L, FTG9-10L+R, FTG9-10R, FTG9-10VL, FTG9-10VL+R, FTG9-10VR, FTGC9-05L, FTGC9-05R, FTGC9-10L, FTGC9-10L+R, FTGC9-10R, GPC-350, MG9-15, MG9-15AD, MG9-15BM, MG9-15BM316...(Other models you can see in the webshop) |                 |                     |

1 gas components

Зип Общепит  
vsezip.ru  
+7(812)987-08-81

|   |   |                 |                     |
|---|---|-----------------|---------------------|
|  |   |                 |                     |
| 1   |   |                 |                     |
| <b>GEV No.</b>  | 109430  | <b>Ref. No.</b> | 12008808<br>9429400 |
| <b>description</b>  | gas injector thread M10x1 WS 13 bore ø 1.8mm  |                 |                     |
| <b>For models:</b>  | CG-1502, CG-210, CG-210G, CG-310, CG-310G, CG-7415, CG-7615, FG-710, FG-720, FG9-05, FG9-05-1C, FG9-05-2C, FG9-05AD, FG9-05PLUS, FG9-05PLUS-S, FG9-05S, FG9-05S-1C, FG9-05S-2C, FG9-05S-AD, FG9-10, FG9-10-2C, FG9-10-4C, FG9-10AD, FG9-10PLUS, FTE7-05, FTE7-10, FTG7-05, FTG7-10, FTGC7-05L, FTGC7-10L, HP-G-15, HPG-15 |                 |                     |

|   |  |                 |                     |
|---|--|-----------------|---------------------|
|  |  |                 |                     |
| 1   |  |                 |                     |
| <b>GEV No.</b>  | 109429   | <b>Ref. No.</b> | 12008794<br>U112402 |
| <b>description</b>  | gas injector thread M10x1 WS 13 bore ø 2.1mm   |                 |                     |
| <b>For models:</b>  | BG7-05, BG7-05I, BG7-10, BG7-10I, CG9-20, CG9-20AD, CG9-20AD-H, CG9-20H, CG9-20PLUS, CG9-20PLUS-H, CG9-31PLUS-D, CG9-31PLUS-I, CG9-40, CG9-40AD, CG9-40AD-H, CG9-40H, CG9-40PLUS, CG9-40PLUS-H, CG9-41, CG9-41AD, CG9-41AD-H, CG9-41H, CG9-41PLUS, CG9-41PLUS-H, CG9-51L, CG9-51LC, CG9-51R, CG9-51RC, CG9-60, CG9-60AD, CG9-60AD-H, CG9-60H, CG9-60PLUS, CG9-60PLUS-H, CG9-61, CG9-61AD, CG9-61AD-H, CG9-61H, CG9-61OP, CG9-61PLUS, CG9-61PLUS-H, CG9-82, CG9-82AD, CG9-82PLUS, CGE9-41, CGE9-41AD, CGE9-41PLUS, CGF9-120D, CGF9-120D-AD, CGF9-120I...(Other models you can see in the webshop) |                 |                     |

|   |   |                 |                     |
|---|---|-----------------|---------------------|
|  |   |                 |                     |
| 1   |   |                 |                     |
| <b>GEV No.</b>  | 109432  | <b>Ref. No.</b> | 12008811<br>9429500 |
| <b>description</b>  | gas injector thread M10x1 WS 13 bore ø 1.9mm  |                 |                     |
| <b>For models:</b>  | BG7-05, BG7-05I, BG7-10, BG7-10I, BMG7-10, BMG9-10, BMG9-10V-T, CG-200S, CG-210, CG-210G, CG-300S, CG-310, CG-310G, CG7-11, CG7-40, CG7-41, CG7-61, CGB7-61, CGE7-105, CGE7-41, FG-920, FG-940, FI-5420, FI-7630, FTG7-05, FTG7-7050L, FTG7-7050R, FTG7-05L, FTG7-05R, FTG7-05VL, FTG7-05VR, FTG7-10, FTG-7100L, FTG-7100L+R, FTG-7100R, FTG7-10L, FTG7-10L+R, FTG7-10R, FTG7-10VL, FTG7-10VL+R, FTG7-10VR, FTGC7-05L, FTGC7-10L, SBG7-10 |                 |                     |

|   |   |                 |  |
|---|---|-----------------|--|
|  |   |                 |  |
| 1   |   |                 |  |
| <b>GEV No.</b>  | 109439  | <b>Ref. No.</b> | 1011600<br>12008804<br>12040507<br>9101160 |
| <b>description</b>  | gas injector thread M10x1 WS 13 bore ø 2.25mm   |                 |  |
| <b>For models:</b>  | BG7-05, BG7-05I, BG7-10, BG7-10I, BG9-05, BG9-05I, BG9-10, BG9-10I, CG9-11, CG9-41, CG9-51L, CG9-51LC, CG9-51R, CG9-51RC, CG9-61, CG9-82, CGF9-121D, CGF9-121I, CG-HP-20, CPG9-05, CPG9-05AD, CPG9-05AD-S, CPG9-05NC, CPG9-05PLUS, CPG9-05PLUS-S, CPG9-05S, CPG9-05SNC, FTG9-05L, FTG9-05L-AD, FTG9-05LV-AD, FTG9-05PLUS-CL, FTG9-05PLUS-CR, FTG9-05PLUS-L, FTG9-05PLUS-LV, FTG9-05PLUS-R, FTG9-05PLUS-RV, FTG9-05R, FTG9-05R-AD, FTG9-05RV-AD, FTG9-05VL, FTG9-05VR, FTG9-10L, FTG9-10L+R, FTG9-10L+R-AD, FTG9-10L+RV-AD, FTG9-10L-AD, FTG9-10LV-AD, FTG9-10PLUS-CL, FTG9-10PLUS-CLR, FTG9-10PLUS-CR...(Other models you can see in the webshop) |                 |  |

|  |  |                 |                     |
|--|--|-----------------|---------------------|
|  |  |                 |                     |
| 1  |  |                 |                     |
| <b>GEV No.</b>   | 109411   | <b>Ref. No.</b> | 12008813<br>U149402 |
| <b>description</b>   | gas injector thread M10x1 WS 13 bore ø 1mm   |                 |                     |
| <b>For models:</b>   | PL-105C, PL-105L, PL-110C, PL-110L, PL-110L+R, PL-110R, SBG9-10PLUS-I, SBG9-10PLUS-IM, SBG9-10PLUS-SI, SBG9-10PLUS-SIM |                 |                     |

|   |   |                 |                     |
|---|---|-----------------|---------------------|
|  |   |                 |                     |
| 1   |   |                 |                     |
| <b>GEV No.</b>  | 109441  | <b>Ref. No.</b> | 12024248<br>R275050 |
| <b>description</b>  | gas injector thread M10x1 WS 13 bore ø 2.35mm   |                 |                     |
| <b>For models:</b>  | CG-1002, CG-1502, CG-2002, CG-2002P, CG9-40, CG9-41, CG9-51L, CG9-51LC, CG9-51R, CG9-51RC, CG9-60, CG9-61, CG9-82, CGE9-41, FTG7-05L, FTG7-05R, FTG7-05VL, FTG7-05VR, FTG7-10L, FTG7-10L+R, FTG7-10R, FTG7-10VL, FTG7-10VL+R, FTG7-10VR, FTGC7-05L, FTGC7-10L |                 |                     |

|   |  |                 |                     |
|---|--|-----------------|---------------------|
|  |  |                 |                     |
| 1   |  |                 |                     |
| <b>GEV No.</b>  | 109437   | <b>Ref. No.</b> | 12008798<br>U262400 |
| <b>description</b>  | gas injector thread M10x1 WS 13 bore ø 2.15mm  |                 |                     |
| <b>For models:</b>  | CG7-10, CG7-11, CG-7115, CG9-11, CG9-11AD, CG9-11PLUS, CG9-20H, CG9-31PLUS-D, CG9-31PLUS-I, CG9-40H, CG9-41, CG9-41AD, CG9-41AD-H, CG9-41H, CG9-41PLUS, CG9-41PLUS-H, CG9-51L, CG9-51LC, CG9-51R, CG9-51RC, CG9-60H, CG9-61, CG9-61AD, CG9-61AD-H, CG9-61H, CG9-61OP, CG9-61PLUS, CG9-61PLUS-H, CG9-82, CG9-82AD, CG9-82PLUS, CGF9-121D, CGF9-121D-AD, CGF9-121I, CGF9-121I-AD, CGF9-121PLUS-D, CGF9-121PLUS-I, CGP9-11, FTG9-05L, FTG9-05PLUS-CL, FTG9-05PLUS-CR, FTG9-05PLUS-L, FTG9-05PLUS-R, FTG9-05R, FTG9-05VL, FTG9-05VR, FTG9-10L, FTG9-10L+R, FTG9-10PLUS-CL, FTG9-10PLUS-CLR...(Other models you can see in the webshop) |                 |                     |

|   |  |                 |                     |
|---|--|-----------------|---------------------|
|  |  |                 |                     |
| 1   |  |                 |                     |
| <b>GEV No.</b>  | 109444   | <b>Ref. No.</b> | 12008803<br>U054400 |
| <b>description</b>  | gas injector thread M10x1 WS 13 bore ø 2.5mm   |                 |                     |
| <b>For models:</b>  | BG9-05, BG9-05AD, BG9-05I, BG9-05PF, BG9-05PI, BG9-05PLUS-I, BG9-10, BG9-10AD, BG9-10I, BG9-10PF, BG9-10PI, BG9-10PLUS-I, BMG9-05, BMG9-05V-T, CG-1002, CG-1502, CG-2000, CG-2000-2P, CG-2002, CG-2002P, CG9-10, CG9-10AD, CG9-10PLUS, CG9-11, CG9-11AD, CG9-11PLUS, CG9-20, CG9-20H, CG9-40, CG9-40H, CG9-41, CG9-41H, CG9-51L, CG9-51LC, CG9-51R, CG9-51RC, CG9-60, CG9-60H, CG9-61, CG9-61H, CG9-61OP, CG9-82, CGE9-11, CGE9-41, CGF9-120D, CGF9-120D-AD, CGF9-120I, CGF9-120I-AD, CGF9-120PLUS-D, CGF9-120PLUS-I...(Other models you can see in the webshop) |                 |                     |





Зип Общепит  
vsezip.ru  
+7(812)987-08-81

|   |  |                 |                    |
|---|--|-----------------|--------------------|
|  |  |                 |                    |
| 1   |  |                 |                    |
| <b>GEV No.</b>  | 109409                                       | <b>Ref. No.</b> | 12008799<br>U05440 |
| <b>description</b>  | gas injector thread M10x1 WS 13 bore ø 2.8mm |                 |                    |
| <b>For models:</b>  | FI-5420, FI-7630, HP-G-15, HPG-15            |                 |                    |

|  |  |                 |                     |
|--|--|-----------------|---------------------|
|  |  |                 |                     |
| 1  |  |                 |                     |
| <b>GEV No.</b>   | 109403   | <b>Ref. No.</b> | 12008719<br>R642400 |
| <b>description</b>   | gas injector thread M10x1 WS 13 bore ø 3.7mm   |                 |                     |
| <b>For models:</b>   | FG9-05, FG9-05-1C, FG9-05-2C, FG9-05S, FG9-05S-1C, FG9-05S-2C, FG9-10, FG9-10-2C, FG9-10-4C, FG-920, FG-940, FTG-7050L, FTG-7050R, FTG-7100L, FTG-7100L+R, FTG-7100R |                 |                     |

|   |  |                 |                     |
|---|--|-----------------|---------------------|
|  |  |                 |                     |
| 1   |  |                 |                     |
| <b>GEV No.</b>  | 109417   | <b>Ref. No.</b> | 12017458<br>U122408 |
| <b>description</b>  | gas injector thread M10x1 WS 13 bore ø 2.95mm  |                 |                     |
| <b>For models:</b>  | CG-200S, CG-210, CG-210G, CG-300S, CG-310, CG-310G, CG-7200, CG-7400, CG-7415, CG-7615, CG9-51L, CG9-51LC, CG9-51R, CG9-51RC, CG-HP-20, FI-5420, FI-7630, FTG9-05L, FTG9-05R, FTG9-05VL, FTG9-05VR, FTG9-10L, FTG9-10L+R, FTG9-10R, FTG9-10VL, FTG9-10VL+R, FTG9-10VR, FTGC9-05L, FTGC9-05R, FTGC9-10L, FTGC9-10L+R, FTGC9-10R |                 |                     |

|  |  |                 |                     |
|--|--|-----------------|---------------------|
|  |  |                 |                     |
| 1  |  |                 |                     |
| <b>GEV No.</b>   | 109400                                     | <b>Ref. No.</b> | 12040563<br>9483100 |
| <b>description</b>   | gas injector thread M10x1 WS 13 bore ø 3mm |                 |                     |
| <b>For models:</b>   | FG-710, FG-720, HPG-35                     |                 |                     |

|   |   |                 |                     |
|---|---|-----------------|---------------------|
|  |   |                 |                     |
| 1   |   |                 |                     |
| <b>GEV No.</b>  | 109404  | <b>Ref. No.</b> | 12008801<br>R302401 |
| <b>description</b>  | gas injector thread M10x1 WS 13 bore ø 2.9mm  |                 |                     |
| <b>For models:</b>  | CG-1002, CG-1502, CG-2000, CG-2002, CG-2002P, CG-200S, CG-210, CG-210G, CG-300S, CG-310, CG-310G, CG7-20, CG7-40, CG7-41, CG7-61, CG9-20, CG9-40, CG9-41, CG9-51L, CG9-51LC, CG9-51R, CG9-51RC, CG9-60, CG9-61, CG9-82, CGB7-61, CGE7-112, CGE7-41, CGE9-41, CGF9-120D, CGF9-120I, CGF9-121D, CGF9-121I, FGCL9-05-1C, FGCL9-05-2C, FGCL9-05S-1C, FGCL9-05S-2C |                 |                     |

|  |   |                 |                     |
|--|---|-----------------|---------------------|
|  |   |                 |                     |
| 1  |   |                 |                     |
| <b>GEV No.</b>   | 109401  | <b>Ref. No.</b> | 12008774<br>U262401 |
| <b>description</b>   | gas injector thread M10x1 WS 13 bore ø 4.1mm  |                 |                     |
| <b>For models:</b>   | CG-1002, CG-1502, CG-2000, CG-2000-2P, CG-2002, CG-2002P, CG7-10, CG7-11, CG9-20, CG9-40, CG9-41, CG9-51L, CG9-51LC, CG9-51R, CG9-51RC, CG9-60, CG9-61, CG9-82, CGE9-41, CGF9-120D, CGF9-120I, CGF9-121D, CGF9-121I |                 |                     |

|   |   |                 |                     |
|---|---|-----------------|---------------------|
|  |   |                 |                     |
| 1   |   |                 |                     |
| <b>GEV No.</b>  | 109434  | <b>Ref. No.</b> | 12008812<br>R614500 |
| <b>description</b>  | gas injector thread M10x1 WS 13 bore ø 2mm  |                 |                     |
| <b>For models:</b>  | BMG-9045, CG-1002, CG-1502, CG-2000, CG-2000-2P, CG-2002, CG-2002P, CG-200S, CG-210, CG-210G, CG-300S, CG-310, CG-310G, CG-7200, CG-7400, CG-7415, CG-7615, CG9-20, CG9-40, CG9-41, CG9-51L, CG9-51LC, CG9-51R, CG9-51RC, CG9-60, CG9-61, CG9-82, CGB7-61, CGE9-41, CGF9-120D, CGF9-120I, CGF9-121D, CGF9-121I, FG-91-20, FG-92-40, SBG9-10I-AD, SBG9-15IM-AD, SBG9-15IM-AD-S |                 |                     |

|  |  |                 |                    |
|--|--|-----------------|--------------------|
|  |  |                 |                    |
| 1  |  |                 |                    |
| <b>GEV No.</b>   | 109402   | <b>Ref. No.</b> | 12008764<br>942460 |
| <b>description</b>   | gas injector thread M10x1 WS 13 bore ø 4.25mm                                      |                 |                    |
| <b>For models:</b>   | FE-91-20, FG-91-20, FG-92-40, FGCL9-05-1C, FGCL9-05-2C, FGCL9-05S-1C, FGCL9-05S-2C |                 |                    |

|   |  |                 |                     |
|---|--|-----------------|---------------------|
|  |  |                 |                     |
| 1   |  |                 |                     |
| <b>GEV No.</b>  | 109405   | <b>Ref. No.</b> | 12008717<br>U742400 |
| <b>description</b>  | gas injector thread M10x1 WS 13 bore ø 3.6mm   |                 |                     |
| <b>For models:</b>  | CG-200S, CG-210, CG-210G, CG-300S, CG-310, CG-310G, CG7-40, CG7-41, CG7-61, CGB7-61, CGE7-106, CGE7-41 |                 |                     |

|  |   |                 |                     |
|--|---|-----------------|---------------------|
|  |   |                 |                     |
| 1  |   |                 |                     |
| <b>GEV No.</b>   | 109412  | <b>Ref. No.</b> | 12008718<br>X102403 |
| <b>description</b>   | gas injector thread M10x1 WS 13 bore ø 4.55mm   |                 |                     |
| <b>For models:</b>   | CG9-10, CG9-11, CGF9-120D, CGF9-120I, CGF9-121D, CGF9-121I, CPG9-05, CPG9-05NC, CPG9-05S, CPG9-05SNC, FTG9-05L, FTG9-05R, FTG9-05VL, FTG9-05VR, FTG9-10L, FTG9-10L+R, FTG9-10R, FTG9-10VL, FTG9-10VL+R, FTG9-10VR, FTG9-11L, FTG9-11L+R, FTG9-11R, FTGC9-05L, FTGC9-05R, FTGC9-10L, FTGC9-10L+R, FTGC9-10R, FTGC9-11L, FTGC9-11L+R, FTGC9-11R, SBG7-10, SBG9-10, SBG9-10I, SBG9-10IM, SBG9-10IMS, SBG9-10IS, SBG9-10M, SBG9-10MS, SBG9-10S, SBG9-15IM, SBG9-15IMS |                 |                     |

1 gas components



1

|                    |   |                 |                     |
|--------------------|---|-----------------|---------------------|
| <b>GEV No.</b>     | 109407  | <b>Ref. No.</b> | 12008763<br>U192402 |
| <b>description</b> | gas injector thread M10x1 WS 13 bore $\varnothing$ 4.9mm  |                 |                     |
| <b>For models:</b> | BMG7-10, BMG9-10, BMG9-10V-T, CG-1002, CG-110, CG-1502, CG-2002, CG-2002P, CG-9110, CG9-40, CG9-41, CG9-51L, CG9-51LC, CG9-51R, CG9-51RC, CG9-60, CG9-61, CG9-82, CGE9-41 |                 |                     |



1

|                    |  |                 |                     |
|--------------------|--|-----------------|---------------------|
| <b>GEV No.</b>     | 109408   | <b>Ref. No.</b> | 12017462<br>R792400 |
| <b>description</b> | gas injector thread M10x1 WS 13 bore $\varnothing$ 4mm   |                 |                     |
| <b>For models:</b> | BG7-05, BG7-05I, BG7-10, BG7-10I, FTG7-05, FTG7-05L, FTG7-05R, FTG7-10, FTG7-10L, FTG7-10L+R, FTG7-10R, FTGC7-05L, FTGC7-10L |                 |                     |



1

|                    |   |                 |                    |
|--------------------|---|-----------------|--------------------|
| <b>GEV No.</b>     | 109406  | <b>Ref. No.</b> | 12008818<br>942450 |
| <b>description</b> | gas injector thread M10x1 WS 13 bore $\varnothing$ 5.35mm                   |                 |                    |
| <b>For models:</b> | BG9-05PF, BG9-05PI, BG9-10PF, BG9-10PI, CG-1002, CG-1502, CG-2002, CG-2002P |                 |                    |

## gas nozzles M14x1



1

|                    |   |                 |                     |
|--------------------|---|-----------------|---------------------|
| <b>GEV No.</b>     | 109450  | <b>Ref. No.</b> | 12021078<br>S312400 |
| <b>description</b> | gas injector thread M14x1 WS 17 bore $\varnothing$ 2.05mm |                 |                     |
| <b>For models:</b> | MG7-10, MG7-10BM  |                 |                     |



1

|                    |  |                 |                     |
|--------------------|--|-----------------|---------------------|
| <b>GEV No.</b>     | 109452   | <b>Ref. No.</b> | 12021165<br>S012400 |
| <b>description</b> | gas injector thread M14x1 WS 17 bore $\varnothing$ 2.2mm                       |                 |                     |
| <b>For models:</b> | MG9-10, MG9-10BM, MG9-10BMS, MG9-10S, MPG9-10, MPG9-10BM, MPG9-10BMS, MPG9-10S |                 |                     |



1

|                    |   |                 |                     |
|--------------------|---|-----------------|---------------------|
| <b>GEV No.</b>     | 109455  | <b>Ref. No.</b> | 12021170<br>S032400 |
| <b>description</b> | gas injector thread M14x1 WS 17 bore $\varnothing$ 2.45mm                                   |                 |                     |
| <b>For models:</b> | MG9-15, MG9-15BM, MG9-15BM316, MG9-15BMS, MG9-15S, MPG9-15, MPG9-15BM, MPG9-15BMS, MPG9-15S |                 |                     |



1

|                    |   |                 |                     |
|--------------------|---|-----------------|---------------------|
| <b>GEV No.</b>     | 109457  | <b>Ref. No.</b> | 12021195<br>S172400 |
| <b>description</b> | gas injector thread M14x1 WS 17 bore $\varnothing$ 2.55mm |                 |                     |
| <b>For models:</b> | MG9-20, MG-9200, MG9-20S, MPG9-20, MPG-9200, MPG9-20S     |                 |                     |



1

|                    |   |                 |                     |
|--------------------|---|-----------------|---------------------|
| <b>GEV No.</b>     | 109462  | <b>Ref. No.</b> | 12021077<br>S312401 |
| <b>description</b> | gas injector thread M14x1 WS 17 bore $\varnothing$ 3.05mm |                 |                     |
| <b>For models:</b> | MG7-10, MG7-10BM  |                 |                     |



1

|                    |  |                 |                     |
|--------------------|--|-----------------|---------------------|
| <b>GEV No.</b>     | 109463   | <b>Ref. No.</b> | 12021206<br>S012401 |
| <b>description</b> | gas injector thread M14x1 WS 17 bore $\varnothing$ 3.1mm                       |                 |                     |
| <b>For models:</b> | MG9-10, MG9-10BM, MG9-10BMS, MG9-10S, MPG9-10, MPG9-10BM, MPG9-10BMS, MPG9-10S |                 |                     |



1

|                    |  |                 |                     |
|--------------------|--|-----------------|---------------------|
| <b>GEV No.</b>     | 109465   | <b>Ref. No.</b> | 12021203<br>S114401 |
| <b>description</b> | gas injector thread M14x1 WS 17 bore $\varnothing$ 3.65mm  |                 |                     |
| <b>For models:</b> | MG-9100, MG9-15, MG9-15BM, MG9-15BM316, MG9-15BMS, MG9-15S, MPG9-15, MPG9-15BM, MPG9-15BMS, MPG9-15S |                 |                     |

Зип Общепит

vsezip.ru

+7(812)987-08-81



Зип Общепит

vsezip.ru

812)987-08-81



1

|                    |  |                 |                     |
|--------------------|--|-----------------|---------------------|
| <b>GEV No.</b>     | 109468   | <b>Ref. No.</b> | 12021216<br>S174400 |
| <b>description</b> | gas injector thread M14x1 WS 17 bore ø 3.8mm                     |                 |                     |
| <b>For models:</b> | MG-9150, MG-9150BM, MG9-20, MG9-20S, MPG-9150, MPG9-20, MPG9-20S |                 |                     |



1

|                    |   |                 |                     |
|--------------------|---|-----------------|---------------------|
| <b>GEV No.</b>     | 109470  | <b>Ref. No.</b> | 12040503<br>S172401 |
| <b>description</b> | gas injector thread M14x1 WS 17 bore ø 3.9mm          |                 |                     |
| <b>For models:</b> | MG9-20, MG-9200, MG9-20S, MPG9-20, MPG-9200, MPG9-20S |                 |                     |

gas nozzles (other)



1

|                    |                            |                 |                     |
|--------------------|----------------------------|-----------------|---------------------|
| <b>GEV No.</b>     | 109475                     | <b>Ref. No.</b> | 12039797<br>T075020 |
| <b>description</b> | gas injector bore ø 1.65mm |                 |                     |
| <b>For models:</b> | HCG-6-11, HMG-6-11         |                 |                     |



1

|                    |                                |                 |                     |
|--------------------|--------------------------------|-----------------|---------------------|
| <b>GEV No.</b>     | 109477                         | <b>Ref. No.</b> | 12021221<br>R725066 |
| <b>description</b> | gas injector bore ø 2.2mm      |                 |                     |
| <b>For models:</b> | HCG-10-11, HCG-6-11, HMG-10-11 |                 |                     |



1

|                    |                           |                 |                     |
|--------------------|---------------------------|-----------------|---------------------|
| <b>GEV No.</b>     | 109497                    | <b>Ref. No.</b> | 12021006<br>R725084 |
| <b>description</b> | gas injector bore ø 2.2mm |                 |                     |
| <b>For models:</b> | HMG-10-11UL               |                 |                     |



1

|                    |  |                 |                     |
|--------------------|--|-----------------|---------------------|
| <b>GEV No.</b>     | 109480   | <b>Ref. No.</b> | 12019416<br>R735010 |
| <b>description</b> | gas injector bore ø 2.5mm  |                 |                     |
| <b>For models:</b> | HCG-10-21, HCG-2-10-11, HCG-6-11, HMG-10-21, HMG-2-10-11, HMG-6-11 |                 |                     |



1

|                    |                            |                 |                     |
|--------------------|----------------------------|-----------------|---------------------|
| <b>GEV No.</b>     | 109485                     | <b>Ref. No.</b> | 12019726<br>T095012 |
| <b>description</b> | gas injector bore ø 2.85mm |                 |                     |
| <b>For models:</b> | HCG-20-11, HMG-20-11       |                 |                     |



1

|                    |  |                 |                     |
|--------------------|--|-----------------|---------------------|
| <b>GEV No.</b>     | 109492   | <b>Ref. No.</b> | 12021231<br>R735009 |
| <b>description</b> | gas injector bore ø 3.5mm                      |                 |                     |
| <b>For models:</b> | HCG-10-21, HCG-2-10-11, HMG-10-21, HMG-2-10-11 |                 |                     |



1

|                    |                                |                 |                     |
|--------------------|--------------------------------|-----------------|---------------------|
| <b>GEV No.</b>     | 109488                         | <b>Ref. No.</b> | 12021232<br>R725067 |
| <b>description</b> | gas injector bore ø 3mm        |                 |                     |
| <b>For models:</b> | HCG-10-11, HMG-10-11, HMG-6-11 |                 |                     |



1

|                    |                           |                 |                     |
|--------------------|---------------------------|-----------------|---------------------|
| <b>GEV No.</b>     | 109496                    | <b>Ref. No.</b> | 12021233<br>T095013 |
| <b>description</b> | gas injector bore ø 4.5mm |                 |                     |
| <b>For models:</b> | HCG-20-11, HMG-20-11      |                 |                     |

1 gas components



**pilot burner nozzles**

**pilot burner nozzles SIT**

**100 series**



|                    |  |                 |                     |
|--------------------|--|-----------------|---------------------|
| <b>GEV No.</b>     | 100245   | <b>Ref. No.</b> | 12021187<br>U442138 |
| <b>description</b> | pilot burner nozzle LPG code 20 bore ø 0.2mm Qty 1 pcs thread M8x0.75  |                 |                     |
| <b>For models:</b> | BG7-05, BG7-05I, BG7-10I, BG9-05, BG9-05I, BG9-10, BG9-10I, BMG7-10, BMG9-05, BMG9-10, CG-1002, CG-1502, CG-2002, CG-2005, CG-210, CG-210G, CG-300S, CG-310, CG-310G, CG7-10, CG7-11, CG7-20, CG7-40, CG7-41, CG7-61, CG9-10, CG9-11, CG9-20, CG9-40, CG9-41, CG9-51L, CG9-51LC, CG9-51R, CG9-51RC, CG9-60, CG9-61, CG9-82, CGB7-61, CGE7-41, CGE9-41, CGF9-120D, CGF9-120I, CGF9-121D, CGF9-121I, CPG9-11, CPG7-05, CPG9-05, CPG9-05NC, CPG9-05S... (Other models you can see in the webshop) |                 |                     |



|                    |   |                 |                     |
|--------------------|---|-----------------|---------------------|
| <b>GEV No.</b>     | 102972  | <b>Ref. No.</b> | 12008938<br>U442137 |
| <b>description</b> | pilot burner nozzle natural gas code 40 bore ø 0.4mm Qty 1 pcs  |                 |                     |
| <b>For models:</b> | BG6-05I, BG7-05, BG7-05I, BG7-10, BG7-10I, BG9-05, BG9-05AD, BG9-05I, BG9-05PF, BG9-05PI, BG9-05PLUS-I, BG9-10, BG9-10AD, BG9-10I, BG9-10PF, BG9-10PI, BG9-10PLUS-I, BMG7-10, BMG9-05, BMG9-05V-T, BMG9-10, BMG9-10V-T, CG-1002, CG-1502, CG-2002, CG-2002P, CG-2005, CG-210, CG-210G, CG-300S, CG-310, CG-310G, CG7-10, CG7-11, CG7-20, CG7-20H, CG7-30D, CG7-30I, CG7-31D, CG7-31I, CG7-40, CG7-40H, CG7-41, CG7-41H, CG7-50, CG7-51, CG7-60, CG7-60H, CG7-61, CG7-61H... (Other models you can see in the webshop) |                 |                     |

**pilot burner nozzles (other)**

**FAGOR**



|                    |   |                 |                     |
|--------------------|---|-----------------|---------------------|
| <b>GEV No.</b>     | 109471  | <b>Ref. No.</b> | 12021092<br>U122401 |
| <b>description</b> | pilot burner nozzle bore ø 0.2mm thread M10x1 WS 12 |                 |                     |
| <b>For models:</b> | CG-HP-20, FI-5420, FI-7630                          |                 |                     |

**bypass nozzles**

**bypass nozzles COPRECI**



|                    |   |                 |                     |
|--------------------|---|-----------------|---------------------|
| <b>GEV No.</b>     | 109195  | <b>Ref. No.</b> | 12016681<br>U022113 |
| <b>description</b> | bypass nozzle type COPRECI bore ø 1.3mm thread M8x0.75 WS 11                          |                 |                     |
| <b>For models:</b> | CG9-40, CG9-41, CG9-51L, CG9-51LC, CG9-51R, CG9-51RC, CG9-60, CG9-61, CG9-82, CGE9-41 |                 |                     |

Зип Общепит

vsezip.ru

+7(812)987-08-81



|                    |   |                 |                     |
|--------------------|---|-----------------|---------------------|
| <b>GEV No.</b>     | 109413  | <b>Ref. No.</b> | 12016664<br>U022111 |
| <b>description</b> | bypass nozzle type COPRECI CAL-3200 bore ø 0.9mm thread M8x0.75 WS 11   |                 |                     |
| <b>For models:</b> | CG9-20, CG9-40, CG9-41, CG9-51L, CG9-51LC, CG9-51R, CG9-51RC, CG9-60, CG9-61, CG9-82, CGE9-41, CGF9-120D, CGF9-120I, CGF9-121D, CGF9-121I |                 |                     |

**auxiliary gas parts**

**screw connections**

**end caps**



|                    |  |                 |                     |
|--------------------|--|-----------------|---------------------|
| <b>GEV No.</b>     | 106342   | <b>Ref. No.</b> | 12008078<br>U635008 |
| <b>description</b> | blind screw connection L 18mm thread M26x1.5 WS 30 brass   |                 |                     |
| <b>For models:</b> | BG7-05, BG7-05I, BG7-10, BG7-10I, BG9-05, BG9-05AD, BG9-05I, BG9-05PF, BG9-05PI, BG9-05PLUS-I, BG9-10, BG9-10AD, BG9-10I, BG9-10PF, BG9-10PI, BG9-10PLUS-I, BMG7-10, BMG9-05, BMG9-05V-T, BMG9-10, BMG9-10V-T, CG-210, CG-210G, CG7-10, CG7-20, CG7-20H, CG7-30D, CG7-30I, CG7-40, CG7-40H, CG7-50, CG7-60, CG7-60H, CG9-05AD, CG9-05PLUS, CG9-10, CG9-10AD, CG9-10PLUS, CG9-20, CG9-40, CG9-60, CGB7-61, CGE7-41, CGE7-41H, CGF9-120D, CGF9-120D-AD, CGF9-120I, CGF9-120I-AD, CGF9-120PLUS-D, CGF9-120PLUS-I... (Other models you can see in the webshop) |                 |                     |

**olives**

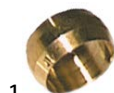

|                        |  |                 |                     |                     |
|------------------------|--|-----------------|---------------------|---------------------|
| <b>GEV No.</b>         | 101273   | <b>Ref. No.</b> | 12008501<br>U055043 |                     |
| <b>description</b>     | olive for pipe ø 12mm L 9.5mm brass Qty 1 pcs suitable for universal   |                 |                     |                     |
| <b>For models:</b>     | BG7-05, BG7-05I, BG7-10, BG7-10I, BG9-05, BG9-05I, BG9-10, BG9-10I, CG-1002, CG-1502, CG-2000, CG-2000-2P, CG-2002, CG-2002P, CG-2005, CG-210, CG-210G, CG-300S, CG-310, CG-310G, CG7-10, CG7-11, CG-7115, CG7-20, CG-7200, CG7-40, CG-7400, CG7-41, CG-7415, CG7-61, CG-7615, CG9-10, CG9-11, CG9-20, CG9-40, CG9-41, CG9-51L, CG9-51LC, CG9-51R, CG9-51RC, CG9-60, CG9-61, CG9-82, CGB7-61, CGE7-138, CGE7-41, CGE9-41, CPG7-05, CPG9-05, CPG9-05NC... (Other models you can see in the webshop) |                 |                     |                     |
| <b>accessories for</b> | 101273   |                 |                     |                     |
|                        | <b>GEV No.</b>   | 100944          | <b>Ref. No.</b>     | 12007951<br>Q221336 |
|                        | union nut thread M18x1.5 for pipe ø 12mm   |                 |                     |                     |
|                        | <b>GEV No.</b>   | 101276          | <b>Ref. No.</b>     | 12008081<br>U264310 |
|                        | union screw thread 3/8" tube ø 12mm Qty 1 pcs  |                 |                     |                     |





Зип Общепит



vsezip.ru

+7(812)9870881

1 gas components



|   |  |                 |                     |
|---|--|-----------------|---------------------|
|  |  |                 |                     |
| 1   |  |                 |                     |
| <b>GEV No.</b>  | 101000   | <b>Ref. No.</b> | 12008775<br>S312106 |
| <b>description</b>  | olive for pipe ø 16mm L 10.5mm brass Qty 1 pcs   |                 |                     |
| <b>For models:</b>  | ACG-102, ACG-201, ACG-202, AG-061, AG-061W, AG-101, AG-101W, AG-102, AG-102W, AG-201, AG-202, APG-061, APG-061W, APG-101, APG-101W, APG-102, APG-102W, APG-201, APG-202, MG7-10, MG7-10BM, MG9-10, MG9-10BM, MG9-10BMS, MG9-10S, MG9-15, MG9-15BM, MG9-15BM316, MG9-15BMS, MG9-15S, MG9-20, MG9-20S, MPG9-10, MPG9-10BM, MPG9-10BMS, MPG9-10S, MPG9-15, MPG9-15BM, MPG9-15BMS, MPG9-15S, MPG9-20, MPG9-20S |                 |                     |

|   |   |                 |                     |
|---|---|-----------------|---------------------|
|  |   |                 |                     |
| 1   |   |                 |                     |
| <b>GEV No.</b>  | 101246  | <b>Ref. No.</b> | 12018994<br>U265026 |
| <b>description</b>  | olive for pipe ø 4mm Qty 1 pcs  |                 |                     |
| <b>For models:</b>  | BG7-05, BG7-05I, BG7-10, BG7-10I, BG9-05, BG9-05I, BG9-10, BG9-10I, CG-1002, CG-1502, CG-2000, CG-2000-2P, CG-2002, CG-2005, CG-210, CG-210G, CG-300S, CG-310, CG-310G, CG7-20, CG-7200, CG7-40, CG-7400, CG7-41, CG-7415, CG7-61, CG-7615, CG9-20, CG9-40, CG9-41, CG9-51L, CG9-51LC, CG9-51R, CG9-51RC, CG9-60, CG9-61, CG9-82, CGB7-61, CGE7-136, CGE7-41, CGE9-41, CGF9-120D, CGF9-120I, CGF9-121D, CGF9-121I, HMG-10-11UL, HMG-10-21UL |                 |                     |



|   |   |                 |  |
|---|---|-----------------|--|
|    |   |                 |  |
| 1   |   |                 |  |
| <b>GEV No.</b>  | 101256  | <b>Ref. No.</b> | 12008773                               |
| <b>description</b>  | olive for pipe ø 16mm Qty 1 pcs   |                 |  |
| <b>For models:</b>  | MG9-10AD, MG9-10BMAD, MG9-10BMSAD, MG9-10PLUS, MG9-10PLUS-BM, MG9-10PLUS-BMS, MG9-10PLUS-S, MG9-10S-AD, MG9-15AD, MG9-15BMAD, MG9-15BMSAD, MG9-15PLUS, MG9-15PLUS-BM, MG9-15PLUS-BMS, MG9-15PLUS-S, MG9-15S-AD, MG9-20AD, MG9-20PLUS, MG9-20PLUS-S, MG9-20S-AD, SBG7-10, SBG9-10, SBG9-10I, SBG9-10I-AD, SBG9-10I-AD-S, SBG9-10IM, SBG9-10IM-AD, SBG9-10IM-AD-S, SBG9-10IMS, SBG9-10IS, SBG9-10M, SBG9-10MS, SBG9-10PLUS-I, SBG9-10PLUS-IM, SBG9-10PLUS-SI, SBG9-10PLUS-SIM, SBG9-10S, SBG9-15IM, SBG9-15IM-AD, SBG9-15IM-AD-S, SBG9-15IMS, SBG9-15PLUS-IM, SBG9-15PLUS-SIM |                 |  |
| <b>accessories for</b>  | 101256  |                 |  |
|  | <b>GEV No.</b>  | 101253          | <b>Ref. No.</b><br>12008865<br>S312105 |
| union nut thread M24x1.5 PEL for pipe ø 16mm  |   |                 |  |

|   |                |        |  |
|---|----------------|--------|--|
| <b>accessories for</b>  | 101246         |        |  |
|  | <b>GEV No.</b> | 100908 | <b>Ref. No.</b><br>12017481<br>T052101 |
| union screw thread M10x1 for pipe ø 4mm Qty 1 pcs                                 |                |        |  |

|   |  |                 |                     |
|---|--|-----------------|---------------------|
|  |  |                 |                     |
| 1   |  |                 |                     |
| <b>GEV No.</b>  | 101879   | <b>Ref. No.</b> | 12019962<br>U135023 |
| <b>description</b>  | olive for pipe ø 5mm Qty 1 pcs   |                 |                     |
| <b>For models:</b>  | CG-210, CG-210G, CG-310, CG-310G, CG-HP-20, FI-5420, FI-7630, HPG-15, HPG-35 |                 |                     |

|   |   |                 |  |
|---|---|-----------------|--|
|  |   |                 |  |
| 1   |   |                 |  |
| <b>GEV No.</b>  | 101274  | <b>Ref. No.</b> | X012105                                |
| <b>description</b>  | olive for pipe ø 16mm Qty 1 pcs   |                 |  |
| <b>For models:</b>  | FG-710, FG-71-15, FG-720, FG-72-30, FG9-05, FG9-05S, FG9-10, FG-91-20, FG-920, FG-92-40, FG-940, SBG7-10, SBG9-10, SBG9-10I, SBG9-10IM, SBG9-10IMS, SBG9-10IS, SBG9-10M, SBG9-10MS, SBG9-10S, SBG9-15IM, SBG9-15IMS |                 |  |
| <b>accessories for</b>  | 101274  |                 |  |
|  | <b>GEV No.</b>  | 101275          | <b>Ref. No.</b><br>12008951<br>X012104 |
| union screw thread 1/2" for pipe ø 16mm Qty 1 pcs                                   |   |                 |  |

|   |   |                 |   |
|---|---|-----------------|---|
|   |   |                 |   |
| 1   |   |                 |   |
| <b>GEV No.</b>  | 101286  | <b>Ref. No.</b> | 12008476<br>S312108000<br>X205028                             |
| <b>description</b>  | olive ID ø 6mm Qty 1 pcs  |                 |   |
| <b>For models:</b>  | BMG7-10, BMG-9045, BMG9-05, BMG9-05V-T, BMG9-10, BMG9-10V-T, CG-1002, CG-1502, CG-2000, CG-2000-2P, CG-2002, CG-2002P, CG-2005, CG-210, CG-210G, CG-300S, CG-310, CG-310G, CG6-41, CG7-10, CG7-11, CG-7115, CG7-41, CG-7415, CG7-61, CG-7615, CG9-05AD, CG9-05PLUS, CG9-10, CG9-10AD, CG9-10PLUS, CG9-11, CG-9110, CG9-11AD, CG9-11PLUS, CG9-20AD, CG9-20AD-H, CG9-20PLUS, CG9-20PLUS-H, CG9-31PLUS-D, CG9-31PLUS-I, CG9-40AD, CG9-40AD-H, CG9-40PLUS, CG9-40PLUS-H, CG9-41, CG9-41AD, CG9-41AD-H, CG9-41PLUS, CG9-41PLUS-H...(Other models you can see in the webshop) |                 |   |
| <b>accessories for</b>  | 101286  |                 |   |
|  | <b>GEV No.</b>  | 100909          | <b>Ref. No.</b><br>12008740<br>12016658<br>S312107<br>U265703 |
| union screw thread M10x1 for pipe ø 6mm Qty 1 pcs                                   |   |                 |   |
|  | <b>GEV No.</b>  | 101464          | <b>Ref. No.</b><br>—  |
| union nut thread M12x1 for pipe ø 6mm   |   |                 |   |

|   |   |                 |  |
|---|---|-----------------|--|
|  |   |                 |  |
| 1   |   |                 |  |
| <b>GEV No.</b>  | 101257  | <b>Ref. No.</b> | 12008828<br>S312104                    |
| <b>description</b>  | olive for pipe ø 20mm Qty 1 pcs   |                 |  |
| <b>For models:</b>  | MG7-10, MG7-10BM, MG9-10, MG9-10BM, MG9-10BMS, MG9-10S, MG9-15, MG9-15BM, MG9-15BM316, MG9-15BMS, MG9-15S, MG9-20, MG9-20S, MPG9-10, MPG9-10BM, MPG9-10BMS, MPG9-10S, MPG9-15, MPG9-15BM, MPG9-15BMS, MPG9-15S, MPG9-20, MPG9-20S |                 |  |
| <b>accessories for</b>  | 101257  |                 |  |
|  | <b>GEV No.</b>  | 101254          | <b>Ref. No.</b><br>12008921<br>S312103 |
| union nut thread M28x1.5 tube ø 20mm  |   |                 |  |

miscellaneous



|                    |  |                 |          |
|--------------------|--|-----------------|----------|
| <b>GEV No.</b>     | 104628   | <b>Ref. No.</b> | 12008165 |
| <b>description</b> | bush thread 3/4" tube ø 17mm for ignition gas pipe WS 30 L 30mm metal Qty 1 pcs  |                 |          |
| <b>For models:</b> | MG9-10, MG9-10BM, MG9-10BMS, MG9-10S, MG9-15, MG9-15BM, MG9-15BM316, MG9-15BMS, MG9-15S, MG9-20, MG9-20S, MPG9-10, MPG9-10BM, MPG9-10BMS, MPG9-10S, MPG9-15, MPG9-15BM, MPG9-15BMS, MPG9-15S, MPG9-20, MPG9-20S, PL-105C, PL-105L, PL-110C, PL-110L, PL-110L+R, PL-110R, SBE9-10, SBE9-10I, SBE9-10IM, SBE9-10IMS, SBE9-10IS, SBE9-10M, SBE9-10MS, SBE9-10S, SBE9-15IM, SBE9-15IMS, SBE9-15M, SBE9-15MS, SBG9-10, SBG9-10I, SBG9-10IM, SBG9-10IMS, SBG9-10IS, SBG9-10M, SBG9-10MS, SBG9-10S, SBG9-15IM, SBG9-15IMS |                 |          |

union nuts



|                    |  |                 |                     |
|--------------------|--|-----------------|---------------------|
| <b>GEV No.</b>     | 103035   | <b>Ref. No.</b> | 12007903<br>Q221334 |
| <b>description</b> | union nut thread 1/2" WS 24 for pipe ø 12mm  |                 |                     |
| <b>For models:</b> | CG-1002, CG-1502, CG-2002, CG-2002P, CG9-11, CG9-41, CG9-51L, CG9-51LC, CG9-51R, CG9-51RC, CG9-61, CG9-82, FI-5420, FI-7630, FTG9-11L, FTG9-11L+R, FTG9-11R, FTGC9-11L, FTGC9-11L+R, FTGC9-11R, HGV-10, HGV-20, HGP-10-21, HGV-10-11, HGV-10-21, HGV-20-11, HVG-10-11, HVG-10-11UL, HVG-10-21, HVG-10-21UL, HVG-20-11, HVG-20-21, HVG-2-10-11, HVG-2-20-21, MFHVG-10-11, MFHVG-10-21, VG-101, VG-102, VG-201, VG-202, VPG-101, VPG-102, VPG-201, VPG-202 |                 |                     |



|                    |   |                 |                     |
|--------------------|---|-----------------|---------------------|
| <b>GEV No.</b>     | 100944  | <b>Ref. No.</b> | 12007951<br>Q221336 |
| <b>description</b> | union nut thread M18x1.5 for pipe ø 12mm  |                 |                     |
| <b>For models:</b> | BG7-05, BG7-05I, BG7-10, BG7-10I, BG9-05, BG9-05I, BG9-10, BG9-10I, CG-1002, CG-1502, CG-2000, CG-2000-2P, CG-2002, CG-2002P, CG-2005, CG-210, CG-210G, CG-300S, CG-310, CG-310G, CG7-10, CG7-11, CG-7115, CG7-20, CG-7200, CG7-40, CG-7400, CG7-41, CG-7415, CG7-61, CG-7615, CG9-10, CG9-11, CG9-20, CG9-40, CG9-41, CG9-51L, CG9-51LC, CG9-51R, CG9-51RC, CG9-60, CG9-61, CG9-82, CGB7-61, CGE7-139, CGE7-41, CGE9-41, CPG7-05, CPG9-05, CPG9-05NC...(Other models you can see in the webshop) |                 |                     |

|   |                |        |                 |                     |
|---|----------------|--------|-----------------|---------------------|
| <b>accessories for</b>  | 100944         |        |                 |                     |
|  | <b>GEV No.</b> | 101273 | <b>Ref. No.</b> | 12008501<br>U055043 |
| olive for pipe ø 12mm L 9.5mm brass Qty 1 pcs suitable for universal                |                |        |                 |                     |

Зип Общепит  
vsezip.ru  
+7(812)987 08 81



|   |   |                 |                     |          |
|---|---|-----------------|---------------------|----------|
| <b>GEV No.</b>  | 101253  | <b>Ref. No.</b> | 12008865<br>S312105 |          |
| <b>description</b>  | union nut thread M24x1.5 PEL for pipe ø 16mm  |                 |                     |          |
| <b>For models:</b>  | MG7-10, MG7-10BM, MG9-10, MG9-10BM, MG9-10BMS, MG9-10S, MG9-15, MG9-15BM, MG9-15BM316, MG9-15BMS, MG9-15S, MG9-20, MG9-20S, MPG9-10, MPG9-10BM, MPG9-10BMS, MPG9-10S, MPG9-15, MPG9-15BM, MPG9-15BMS, MPG9-15S, MPG9-20, MPG9-20S |                 |                     |          |
| <b>accessories for</b>  | 101253  |                 |                     |          |
|  | <b>GEV No.</b>  | 101256          | <b>Ref. No.</b>     | 12008773 |
| olive for pipe ø 16mm Qty 1 pcs   |   |                 |                     |          |



|                    |   |                 |                     |
|--------------------|---|-----------------|---------------------|
| <b>GEV No.</b>     | 106331  | <b>Ref. No.</b> | 12008085<br>U725006 |
| <b>description</b> | union nut thread M26x1.5 WS 30 L 17.5mm brass for pipe ø 17mm   |                 |                     |
| <b>For models:</b> | ACG-102, ACG-201, ACG-202, AG-061, AG-101, AG-102, AG-201, AG-202, APG-061, APG-101, APG-102, APG-201, APG-202, BG7-05, BG7-10, BG9-05, BG9-10, BMG7-10, BMG9-05, BMG9-10, CG-1002, CG-1502, CG-2002, CG7-10, CG7-11, CG7-20, CG7-40, CG7-41, CG7-61, CG9-10, CG9-11, CG9-20, CG9-40, CG9-41, CG9-51L, CG9-51LC, CG9-51R, CG9-51RC, CG9-60, CG9-61, CG9-82, CGB7-61, CGE7-123, CGE7-41, CGE9-41, CPG9-11, CPG7-05, CPG9-05, CPG9-05NC, FG-710...(Other models you can see in the webshop) |                 |                     |



|   |   |                 |                     |                     |
|---|---|-----------------|---------------------|---------------------|
| <b>GEV No.</b>  | 101254  | <b>Ref. No.</b> | 12008921<br>S312103 |                     |
| <b>description</b>  | union nut thread M28x1.5 tube ø 20mm  |                 |                     |                     |
| <b>For models:</b>  | MG7-10, MG7-10BM, MG9-10, MG9-10BM, MG9-10BMS, MG9-10S, MG9-15, MG9-15BM, MG9-15BM316, MG9-15BMS, MG9-15S, MG9-20, MG9-20S, MPG9-10, MPG9-10BM, MPG9-10BMS, MPG9-10S, MPG9-15, MPG9-15BM, MPG9-15BMS, MPG9-15S, MPG9-20, MPG9-20S |                 |                     |                     |
| <b>accessories for</b>  | 101254  |                 |                     |                     |
|  | <b>GEV No.</b>  | 101257          | <b>Ref. No.</b>     | 12008828<br>S312104 |
| olive for pipe ø 20mm Qty 1 pcs   |   |                 |                     |                     |





Зип Общепит

vsezip.ru

+7(812)987-08-81

union screws

1



|                    |  |                 |          |
|--------------------|--|-----------------|----------|
| <b>GEV No.</b>     | 100904   | <b>Ref. No.</b> | 12008755 |
| <b>description</b> | locking screw M10x1 for pipe ø 4mm Qty 1 pcs   |                 |          |
| <b>For models:</b> | BG9-05, BG9-05I, BG9-10, BG9-10I, CG7-20, CG7-20H, CG7-30D, CG7-30I, CG7-31D, CG7-31I, CG7-40, CG7-40H, CG7-41, CG7-41H, CG7-50, CG7-51, CG7-60, CG7-60H, CG7-61, CG7-61H, CGB7-61, CGB7-61H, CGB7-61R, CGB7-61RH, CGE7-41, CGE7-41H |                 |          |

2



|                    |  |                 |                     |
|--------------------|--|-----------------|---------------------|
| <b>GEV No.</b>     | 100905   | <b>Ref. No.</b> | 12008715<br>U134323 |
| <b>description</b> | locking screw M10x1 for pipe ø 6mm Qty 1 pcs   |                 |                     |
| <b>For models:</b> | BG6-05I, BG7-05, BG7-05I, BG7-10, BG7-10I, BMG7-10, BMG9-05, BMG9-05V-T, BMG9-10, BMG9-10V-T, CG-1002, CG-1502, CG-2000, CG-2000-2P, CG-2002, CG-2002P, CG-210, CG-210G, CG-310, CG-310G, CG6-41, CG7-10, CG7-11, CG7-20, CG7-20H, CG7-30D, CG7-30I, CG7-31D, CG7-31I, CG7-40, CG7-40H, CG7-41, CG7-41H, CG7-50, CG7-51, CG7-60, CG7-60H, CG7-61, CG7-61H, CG9-10, CG9-11, CG-9110, CG9-11AD, CG9-11PLUS, CG9-20, CG9-20H, CG9-31PLUS-D, CG9-31PLUS-I, CG9-40, CG9-40H...(Other models you can see in the webshop) |                 |                     |

1



|   |   |                 |                         |
|---|---|-----------------|-------------------------|
| <b>GEV No.</b>  | 101275  | <b>Ref. No.</b> | 12008951<br>X012104     |
| <b>description</b>  | union screw thread 1/2" for pipe ø 16mm Qty 1 pcs   |                 |                         |
| <b>For models:</b>  | FG-710, FG-71-15, FG-720, FG-72-30, FG9-05, FG9-05S, FG9-10, FG-91-20, FG-920, FG-92-40, FG-940, MG9-10AD, MG9-10BMAD, MG9-10BMSAD, MG9-10PLUS, MG9-10PLUS-BM, MG9-10PLUS-BMS, MG9-10PLUS-S, MG9-10S-AD, MG9-15AD, MG9-15BMAD, MG9-15BMSAD, MG9-15PLUS, MG9-15PLUS-BM, MG9-15PLUS-BMS, MG9-15PLUS-S, MG9-15S-AD, MG9-20AD, MG9-20PLUS, MG9-20PLUS-S, MG9-20S-AD, SBG7-10, SBG9-10, SBG9-10I, SBG9-10I-AD, SBG9-10I-AD-S, SBG9-10IM, SBG9-10IM-AD, SBG9-10IM-AD-S, SBG9-10IMS, SBG9-10IS, SBG9-10M, SBG9-10MS, SBG9-10PLUS-I, SBG9-10PLUS-IM, SBG9-10PLUS-SI, SBG9-10PLUS-SIM, SBG9-10S, SBG9-15IM, SBG9-15IM-AD...(Other models you can see in the webshop) |                 |                         |
| <b>accessories for</b>  | 101275  |                 |                         |
|  | <b>GEV No.</b>  | 101274          | <b>Ref. No.</b> X012105 |
|   | olive for pipe ø 16mm Qty 1 pcs   |                 |                         |

1



|                    |  |                 |                     |
|--------------------|--|-----------------|---------------------|
| <b>GEV No.</b>     | 102453   | <b>Ref. No.</b> | 12008018<br>U195009 |
| <b>description</b> | union screw thread 1/8" for pipe ø 1/4" CCT L 12mm brass Qty 1 pcs WS 10   |                 |                     |
| <b>For models:</b> | BMG7-10, BMG-9045, BMG9-05, BMG9-05V-T, BMG9-10, BMG9-10V-T, CG-1002, CG-1502, CG-2002, CG-2002P, CG-2005, CG-210, CG-210G, CG-300S, CG-310, CG-310G, CG6-41, CG7-10, CG7-11, CG-7115, CG7-41, CG-7415, CG7-61, CG-7615, CG9-10, CG9-11, CG-9110, CGB7-61, CGE9-11, CGF9-120D, CGF9-120I, CGF9-121D, CGF9-121I, CPG7-05, CPG9-05, CPG9-05NC, CPG9-05S, CPG9-05SNC, FTG7-05, FTG-7050L, FTG-7050R, FTG7-05L, FTG7-05R, FTG7-05VL, FTG7-05VR, FTG7-10, FTG-7100L, FTG-7100L+R, FTG-7100R, FTG7-10L...(Other models you can see in the webshop) |                 |                     |





1



|                    |   |                 |                     |
|--------------------|---|-----------------|---------------------|
| <b>GEV No.</b>     | 102454  | <b>Ref. No.</b> | 12017406<br>U322109 |
| <b>description</b> | union screw thread 1/8" for pipe ø 4mm L 11mm brass Qty 1 pcs WS 10   |                 |                     |
| <b>For models:</b> | BG7-05, BG7-05I, BG7-10, BG7-10I, BG9-05, BG9-05I, BG9-10, BG9-10I, CG-1002, CG-1502, CG-2000, CG-2000-2P, CG-2002, CG-2005, CG-210, CG-210G, CG-300S, CG-310, CG-310G, CG7-20, CG7-40, CG7-41, CG7-61, CG9-20, CG9-40, CG9-41, CG9-51L, CG9-51LC, CG9-51R, CG9-51RC, CG9-60, CG9-61, CG9-82, CGB7-61, CGE7-135, CGE7-41, CGE9-41, CGF9-120D, CGF9-120I, CGF9-121D, CGF9-121I, HMG-10-11UL, HMG-10-21UL |                 |                     |





1



|   |  |                 |                                     |
|---|--|-----------------|-------------------------------------|
| <b>GEV No.</b>  | 100908   | <b>Ref. No.</b> | 12017481<br>T052101                 |
| <b>description</b>  | union screw thread M10x1 for pipe ø 4mm Qty 1 pcs  |                 |                                     |
| <b>For models:</b>  | BG7-05, BG7-10, BG9-05, BG9-05I, BG9-10, BG9-10I, CG-200S, CG-210, CG-210G, CG-300S, CG-310, CG-310G |                 |                                     |
| <b>accessories for</b>  | 100908   |                 |                                     |
|  | <b>GEV No.</b>   | 100897          | <b>Ref. No.</b> —                   |
|   | olive for pipe ø 4mm Qty 1 pcs for pilot burner  |                 |                                     |
|  | <b>GEV No.</b>   | 101246          | <b>Ref. No.</b> 12018994<br>U265026 |
|   | olive for pipe ø 4mm Qty 1 pcs   |                 |                                     |
|  | <b>GEV No.</b>   | 101280          | <b>Ref. No.</b> —                   |
|   | olive for pipe ø 4mm Qty 1 pcs   |                 |                                     |
|  | <b>GEV No.</b>   | 101282          | <b>Ref. No.</b> —                   |
|   | olive for pipe ø 4mm L 7.4mm Qty 1 pcs   |                 |                                     |

1 gas components

Зип Общепит  
vsezip.ru  
7(812)987-08-81

|   |  |                 |   |
|---|--|-----------------|---|
|    |  |                 |   |
| 1   |  |                 |   |
| <b>GEV No.</b>  | 100909   | <b>Ref. No.</b> | 12008740<br>12015653<br>S312107<br>U265703        |
| <b>description</b>  | union screw thread M10x1 for pipe ø 6mm Qty 1 pcs  |                 |   |
| <b>For models:</b>  | CG-2005, CG-210, CG-210G, CG-3005, CG-310, CG-310G, CG-7200, CG-7400, CG-7415, CG-7615, CG9-05AD, CG9-05PLUS, CG9-10AD, CG9-10PLUS, CG9-11AD, CG9-11PLUS, CG9-20AD, CG9-20AD-H, CG9-20PLUS, CG9-20PLUS-H, CG9-31PLUS-D, CG9-31PLUS-I, CG9-40AD, CG9-40AD-H, CG9-40PLUS, CG9-40PLUS-H, CG9-41AD, CG9-41AD-H, CG9-41PLUS, CG9-41PLUS-H, CG9-60AD, CG9-60AD-H, CG9-60PLUS, CG9-60PLUS-H, CG9-61AD, CG9-61AD-H, CG9-61PLUS, CG9-61PLUS-H, CG9-82AD, CG9-82PLUS, CGE9-41AD, CGE9-41PLUS, CGF9-120D-AD, CGF9-120I-AD, CGF9-120PLUS-D, CGF9-120PLUS-I, CGF9-121D-AD, CGF9-121I-AD, CGF9-121PLUS-D, CGF9-121PLUS-I...(Other models you can see in the webshop) |                 |   |
| <b>accessories for</b>  | 100909   |                 |   |
|    | <b>GEV No.</b>   | 100898          | <b>Ref. No.</b> —                                 |
|   | olive for pipe ø 6mm Qty 1 pcs for pilot burner  |                 |   |
|    | <b>GEV No.</b>   | 101286          | <b>Ref. No.</b> 12008476<br>S312108000<br>X205028 |
|   | olive ID ø 6mm Qty 1 pcs   |                 |   |
|   | <b>GEV No.</b>   | 101287          | <b>Ref. No.</b> —                                 |
|   | olive for pipe ø 6mm Qty 1 pcs   |                 |   |
|  | <b>GEV No.</b>   | 101288          | <b>Ref. No.</b> —                                 |
|   | olive for pipe ø 6mm L 6mm aluminium Qty 1 pcs ED ø 8.5mm  |                 |   |

|   |  |                 |                     |
|---|--|-----------------|---------------------|
| <b>angle pieces</b>   |  |                 |                     |
|  |  |                 |                     |
| 1   |  |                 |                     |
| <b>GEV No.</b>  | 106415   | <b>Ref. No.</b> | 12009102<br>S115013 |
| <b>description</b>  | angle piece  |                 |                     |
| <b>For models:</b>  | BME7-05, BME9-05, BMG9-05, CPE7-05, CPE7-05NC, CPE9-05, CPE9-05S, CPG7-05, CPG7-05NC, CPG9-05, CPG9-05S, EPC-350, GPC-350, LA-13M, LA-18MP, LA-V-10M, LA-V-10MP, LA-V-13M, LA-V-13MP, LA-V-18M, LA-V-18MP, LB-AC-10M, LB-E-10M, LB-V-10M, LF-13MPP, LF-18MPP, LF-8MPP, LR-V-10M, LR-V-10MP, LR-V-13M, LR-V-13MP, LR-V-18M, LR-V-18MP, LR-V-25M, LR-V-25MP, ME7-10BM, ME9-10BM, ME9-10BMS, ME9-15BM, ME9-15BM316, ME9-15BMS, MG7-10, MG7-10BM, MG9-10, MG-9100, MG9-10BM, MG9-10BMS, MG9-10S, MG9-15, MG-9150...(Other models you can see in the webshop) |                 |                     |

|   |   |                 |                     |
|---|---|-----------------|---------------------|
| <b>accessories</b>  |   |                 |                     |
|  |   |                 |                     |
| 1   |   |                 |                     |
| <b>GEV No.</b>  | 694676  | <b>Ref. No.</b> | 12009347<br>U195420 |
| <b>description</b>  | cast plate cast iron ø 260mm COCINA CG9-10 suitable for FAGOR   |                 |                     |
| <b>For models:</b>  | CG-110, CG7-10, CG7-11, CG-7115, CG9-05AD, CG9-05PLUS, CG9-10, CG9-10AD, CG9-10PLUS, CG9-11, CG-9110, CG9-11AD, CG9-11PLUS, CGE9-11, CGF9-120D, CGF9-120D-AD, CGF9-120I, CGF9-120I-AD, CGF9-120PLUS-D, CGF9-120PLUS-I, CGF9-121D, CGF9-121D-AD, CGF9-121I, CGF9-121I-AD, CGF9-121PLUS-D, CGF9-121PLUS-I |                 |                     |

|   |  |                 |                     |
|---|--|-----------------|---------------------|
|  |  |                 |                     |
| 1   |  |                 |                     |
| <b>GEV No.</b>  | 109100   | <b>Ref. No.</b> | 12010033<br>Q153002 |
| <b>description</b>  | screw for nozzle holder  |                 |                     |
| <b>For models:</b>  | BG7-05, BG7-05I, BG7-10, BG7-10I, BG9-05, BG9-05AD, BG9-05I, BG9-05PF, BG9-05PI, BG9-05PLUS-I, BG9-10, BG9-10AD, BG9-10I, BG9-10PF, BG9-10PI, BG9-10PLUS-I, BMG7-10, BMG-9045, BMG9-05, BMG9-10, CG-1002, CG-1502, CG-2000, CG-2000-2P, CG-2002, CG-2002P, CG-2005, CG-210, CG-210G, CG-3005, CG-310, CG-310G, CG7-10, CG7-11, CG-7115, CG7-20, CG-7200, CG7-20H, CG7-30D, CG7-30I, CG7-31D, CG7-31I, CG7-40, CG-7400, CG7-40H, CG7-41, CG-7415, CG7-41H, CG7-50, CG7-51...(Other models you can see in the webshop) |                 |                     |

|  |   |                 |                     |
|--|---|-----------------|---------------------|
| <b>gas lines</b>   |   |                 |                     |
| <b>main gas lines</b>  |   |                 |                     |
| <b>producer-specific</b>   |   |                 |                     |
|  |   |                 |                     |
| 1  |   |                 |                     |
| <b>GEV No.</b>   | 109061  | <b>Ref. No.</b> | 12008153<br>U565007 |
| <b>description</b>   | connection angle tube ø 15mm L 70mm   |                 |                     |
| <b>For models:</b>   | CG-1002, CG-1502, CG-2002, CG7-11, CG7-41, CG7-61, CG9-11, CG9-41, CG9-51L, CG9-51LC, CG9-51R, CG9-51RC, CG9-61, CG9-82, CGB7-61, CGE7-41, CGE9-41, CGP9-11, CPG7-05, CPG9-05, CPG9-05NC, FG-710, FG-720, FG9-05, FG9-10, FTG9-11L, FTG9-11L+R, FTG9-11R, FTGC9-11L, FTGC9-11L+R, FTGC9-11R, HG9-10, HG9-20, MG7-10, MG7-10BM, MG9-10, MG9-10BM, MG9-10BMS, MG9-10S, MG9-15, MG9-15BM, MG9-15BM316, MG9-15BMS, MG9-15S, MG9-20, MG9-20S, MPG9-10, MPG9-10BM, MPG9-15, MPG9-15BM...(Other models you can see in the webshop) |                 |                     |

|  |          |                 |                     |
|--|----------|-----------------|---------------------|
|  |          |                 |                     |
| 1  |          |                 |                     |
| <b>GEV No.</b>   | 106263   | <b>Ref. No.</b> | 12015649<br>U725008 |
| <b>description</b>   | gas line |                 |                     |
| <b>For models:</b>   | CG7-20   |                 |                     |



Зип Общепит

vsezip.ru

+7(812)987-08-81



1

|                    |                         |                 |         |
|--------------------|-------------------------|-----------------|---------|
| <b>GEV No.</b>     | 106416                  | <b>Ref. No.</b> | S045012 |
| <b>description</b> | gas line L 260mm ø 20mm |                 |         |



1

|                    |                                    |                 |                     |
|--------------------|------------------------------------|-----------------|---------------------|
| <b>GEV No.</b>     | 109071                             | <b>Ref. No.</b> | 12019057<br>T125026 |
| <b>description</b> | gas line tube ø 14mm L 420mm WS 24 |                 |                     |
| <b>For models:</b> | HVG-10-21                          |                 |                     |



Image not available

1

|                    |  |                 |                        |
|--------------------|--|-----------------|------------------------|
| <b>GEV No.</b>     | 107928   | <b>Ref. No.</b> | 12019022<br>H015018000 |
| <b>description</b> | gas line tube ø 12mm copper with nozzle holder |                 |                        |



1

|                    |   |                 |                     |
|--------------------|---|-----------------|---------------------|
| <b>GEV No.</b>     | 106343  | <b>Ref. No.</b> | 12017786<br>S035025 |
| <b>description</b> | gas line tube ø 16mm L 150mm IT M14x1 ET 1/2" |                 |                     |
| <b>For models:</b> | MG9-15, MG9-15S, MPG9-15, MPG9-15S            |                 |                     |



1

|                    |  |                 |                     |
|--------------------|--|-----------------|---------------------|
| <b>GEV No.</b>     | 106340   | <b>Ref. No.</b> | 12013654<br>U745023 |
| <b>description</b> | gas line tube ø 12mm SS with nozzle holder                 |                 |                     |
| <b>For models:</b> | CG7-20, CG7-40, CG7-41, CG7-61, CGB7-61, CGE7-128, CGE7-41 |                 |                     |



1

|                    |                              |                 |         |
|--------------------|------------------------------|-----------------|---------|
| <b>GEV No.</b>     | 106412                       | <b>Ref. No.</b> | S045020 |
| <b>description</b> | gas line tube ø 16mm L 310mm |                 |         |



1

|                    |   |                 |  |
|--------------------|---|-----------------|--|
| <b>GEV No.</b>     | 106339  | <b>Ref. No.</b> | 12008392<br>12019896<br>U025014<br>U565023 |
| <b>description</b> | gas line tube ø 12mm SS without screw connection  |                 |  |
| <b>For models:</b> | CG-1002, CG-1502, CG9-11, CG9-41, CG9-51L, CG9-51LC, CG9-51R, CG9-51RC, CG9-61, CG9-82, CGF9-121D, CGF9-121I, FTG9-11L, FTG9-11L+R, FTG9-11R, FTGC9-11L, FTGC9-11L+R, FTGC9-11R, HG9-10, HG9-15, HG9-20 |                 |  |



1

|                    |   |                 |                                 |
|--------------------|---|-----------------|---------------------------------|
| <b>GEV No.</b>     | 106413  | <b>Ref. No.</b> | 12014116<br>12017567<br>S035030 |
| <b>description</b> | gas line tube ø 21mm  |                 |                                 |
| <b>For models:</b> | MG9-10, MG9-10BM, MG9-15, MG9-15BM, MG9-15S, MG9-20, MG9-20S, MPG9-10, MPG9-10BM, MPG9-15, MPG9-15BM, MPG9-15S, MPG9-20, MPG9-20S |                 |                                 |

1 gas components



## pilot tubes

## producer-specific



Image not available

1

|                    |                |                 |                     |
|--------------------|----------------|-----------------|---------------------|
| <b>GEV No.</b>     | 109301         | <b>Ref. No.</b> | 12019938<br>U745006 |
| <b>description</b> | pilot tube     |                 |                     |
| <b>For models:</b> | CG7-41, CG7-61 |                 |                     |

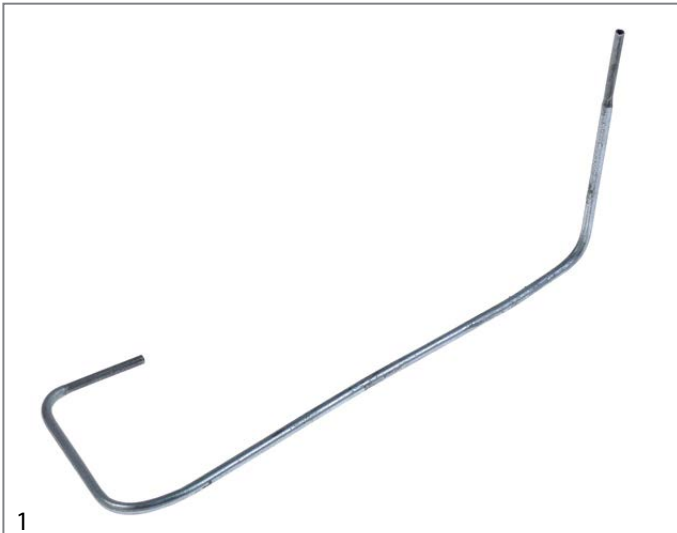

1

|                    |  |                 |                     |
|--------------------|--|-----------------|---------------------|
| <b>GEV No.</b>     | 106414                                       | <b>Ref. No.</b> | 12020132<br>T035001 |
| <b>description</b> | pilot tube tube $\varnothing$ 4.75mm L 260mm |                 |                     |
| <b>For models:</b> | BG7-05, BG7-10                               |                 |                     |

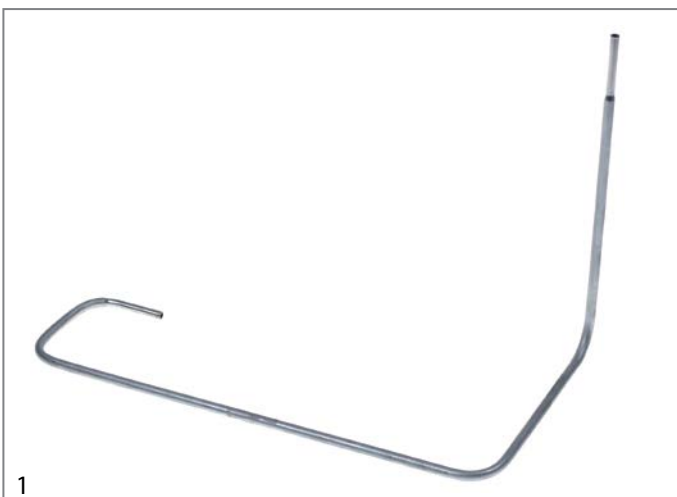

1

|                    |   |                 |                     |
|--------------------|---|-----------------|---------------------|
| <b>GEV No.</b>     | 106264                                    | <b>Ref. No.</b> | 12020093<br>H015014 |
| <b>description</b> | pilot tube tube $\varnothing$ 4/5mm steel |                 |                     |
| <b>For models:</b> | BG9-05, BG9-05I, BG9-10, BG9-10I          |                 |                     |

Зип Общепит

vsezip.ru

+7(812)987-08-81

1

|                    |   |                 |                     |
|--------------------|---|-----------------|---------------------|
| <b>GEV No.</b>     | 106336  | <b>Ref. No.</b> | 12019504<br>U745011 |
| <b>description</b> | pilot tube tube $\varnothing$ 4mm SS without screw connection |                 |                     |
| <b>For models:</b> | CG7-40, CG7-41, CG7-61, CGB7-61, CGE7-133, CGE7-41            |                 |                     |



1

|                    |   |                 |                     |
|--------------------|---|-----------------|---------------------|
| <b>GEV No.</b>     | 106338  | <b>Ref. No.</b> | 12019498<br>U565034 |
| <b>description</b> | pilot tube tube $\varnothing$ 4mm SS without screw connection                                 |                 |                     |
| <b>For models:</b> | CG9-20, CG9-40, CG9-41, CG9-51L, CG9-51LC, CG9-51R, CG9-51RC, CG9-60, CG9-61, CG9-82, CGE9-41 |                 |                     |

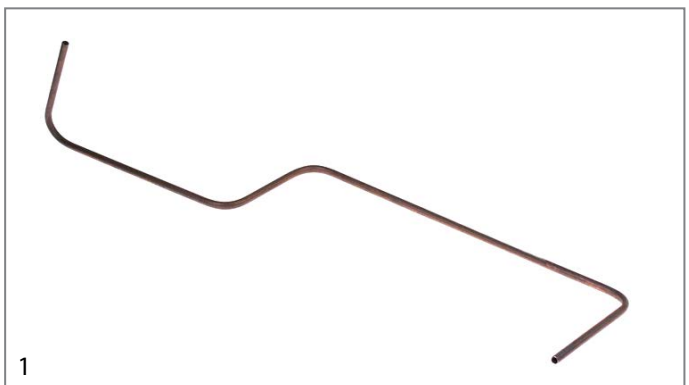

1

|                    |  |                 |                     |
|--------------------|--|-----------------|---------------------|
| <b>GEV No.</b>     | 106333   | <b>Ref. No.</b> | 12020165<br>S015012 |
| <b>description</b> | pilot tube tube $\varnothing$ 6mm copper without screw connection              |                 |                     |
| <b>For models:</b> | MG9-10, MG9-10BM, MG9-10BMS, MG9-10S, MPG9-10, MPG9-10BM, MPG9-10BMS, MPG9-10S |                 |                     |

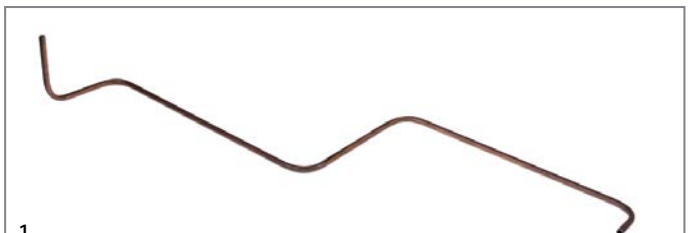

1

|                    |   |                 |                     |
|--------------------|---|-----------------|---------------------|
| <b>GEV No.</b>     | 106334  | <b>Ref. No.</b> | 12020169<br>S045031 |
| <b>description</b> | pilot tube tube $\varnothing$ 6mm copper without screw connection                           |                 |                     |
| <b>For models:</b> | MG9-15BM, MG9-15BM316, MG9-15BMS, MG9-20, MG9-20S, MPG9-15BM, MPG9-15BMS, MPG9-20, MPG9-20S |                 |                     |



Зип Общежит

accessories

vsezip.ru

+7(812)987-08-81



1

|                    |   |                 |          |
|--------------------|---|-----------------|----------|
| <b>GEV No.</b>     | 109110  | <b>Ref. No.</b> | 12014422 |
| <b>description</b> | pilot tube tube ø 6mm L 640mm copper  |                 |          |
| <b>For models:</b> | CG9-20, CG9-40, CG9-41, CG9-51L, CG9-51LC, CG9-51R, CG9-51RC, CG9-60, CG9-61, CG9-82, CGE9-41, CGF9-120D, CGF9-120I, CGF9-121D, CGF9-121I |                 |          |





1

|                    |   |                 |                     |
|--------------------|---|-----------------|---------------------|
| <b>GEV No.</b>     | 106337  | <b>Ref. No.</b> | 12020337<br>R165019 |
| <b>description</b> | pilot tube tube ø 6mm SS without screw connection   |                 |                     |
| <b>For models:</b> | FTG9-05L, FTG9-05R, FTG9-05VL, FTG9-05VR, FTG9-10L, FTG9-10L+R, FTG9-10R, FTG9-10VL, FTG9-10VL+R, FTG9-10VR, FTG9-11L, FTG9-11L+R, FTG9-11R, FTGC9-05, FTGC9-05L, FTGC9-05R, FTGC9-10, FTGC9-10L, FTGC9-10L+R, FTGC9-10R, FTGC9-11L, FTGC9-11L+R, FTGC9-11R |                 |                     |

universal



1

|   |   |                 |                 |                     |
|---|---|-----------------|-----------------|---------------------|
| <b>GEV No.</b>  | 102110  | <b>Ref. No.</b> | 12019428        |                     |
| <b>description</b>  | pilot tube copper pipe ø 4mm thickness 1mm L 3000mm |                 |                 |                     |
| <b>For models:</b>  | BG9-05, BG9-05I, BG9-10, BG9-10I                    |                 |                 |                     |
| <b>accessories for</b>  | 102110  |                 |                 |                     |
|  | <b>GEV No.</b>                                      | 100908          | <b>Ref. No.</b> | 12017481<br>T052101 |
|   | union screw thread M10x1 for pipe ø 4mm Qty 1 pcs   |                 |                 |                     |
|  | <b>GEV No.</b>                                      | 101246          | <b>Ref. No.</b> | 12018994<br>U265026 |
|   | olive for pipe ø 4mm Qty 1 pcs                      |                 |                 |                     |



1

|                    |  |                 |                     |
|--------------------|--|-----------------|---------------------|
| <b>GEV No.</b>     | 691761   | <b>Ref. No.</b> | 12017847<br>R725060 |
| <b>description</b> | clamping ring ø 33.5mm wire gauge ø 2mm  |                 |                     |
| <b>For models:</b> | HCG-10-11, HCG-10-21, HCG-20-11, HCG-2-10-11, HCG-6-11, HMG-10-11, HMG-10-11UL, HMG-10-21, HMG-10-21UL, HMG-20-11, HMG-2-10-11, HMG-6-11 |                 |                     |

gas hoses

miscellaneous



1

|                    |  |                 |                     |
|--------------------|--|-----------------|---------------------|
| <b>GEV No.</b>     | 109074   | <b>Ref. No.</b> | 12017902<br>R725019 |
| <b>description</b> | gas hose L 400mm nominal-ø 23mm  |                 |                     |
| <b>For models:</b> | HCG-10-11, HCG-10-21, HCG-2-10-11, HMG-10-11, HMG-10-11UL, HMG-10-21, HMG-10-21UL, HMG-2-10-11 |                 |                     |

pressure switches



1

|                    |                  |                 |                        |
|--------------------|------------------|-----------------|------------------------|
| <b>GEV No.</b>     | 541108           | <b>Ref. No.</b> | 12029376<br>RT30171004 |
| <b>description</b> | pressure control |                 |                        |



1

|                    |  |                 |                     |
|--------------------|--|-----------------|---------------------|
| <b>GEV No.</b>     | 541304   | <b>Ref. No.</b> | 12018227<br>R723004 |
| <b>description</b> | pressure control pressure range 2.7/2.15mbar pressure connection horizontal gas technology connection 6mm      |                 |                     |
| <b>For models:</b> | HCG-10-11, HCG-10-21, HCG-20-11, HCG-2-10-11, HCG-6-11, HMG-10-11, HMG-10-21, HMG-20-11, HMG-2-10-11, HMG-6-11 |                 |                     |

1 gas components

ЗипОбщедит  
for dough mixers

drive shafts  
vsezip.ru

7(812)987-08-81



|                    |  |                 |                        |
|--------------------|--|-----------------|------------------------|
| <b>GEV No.</b>     | 541111   | <b>Ref. No.</b> | 12030211<br>RT30171010 |
| <b>description</b> | pressure control pressure range adjustable 0.2- 3mbar pressure connection horizontal gas technology connection 6mm suitable for RATIONAL |                 |                        |



|                    |  |                 |                     |
|--------------------|--|-----------------|---------------------|
| <b>GEV No.</b>     | 691875   | <b>Ref. No.</b> | 12039839<br>R010502 |
| <b>description</b> | spindle L 50mm W 16mm  |                 |                     |
| <b>For models:</b> | HCV-10-11, HCV-10-21, HCV-2-10-21, HCV-6-11, HE-10-11, HE-10-21, HE-2-10-11, HE-6-11, HG-10-11, HG-10-21, HG-2-10-11 |                 |                     |

## equipment-specific units

### for vegetable slicers

#### miscellaneous



|                    |  |                 |                                |
|--------------------|--|-----------------|--------------------------------|
| <b>GEV No.</b>     | 110703   | <b>Ref. No.</b> | 12020819<br>T055434<br>T055440 |
| <b>description</b> | cylindrical handle thread M10 ø 28mm L 87mm      |                 |                                |
| <b>For models:</b> | BG7-05, BG7-10, BG9-05, BG9-05I, BG9-10, BG9-10I |                 |                                |

### chains

#### connectors



|                    |   |                 |                     |
|--------------------|---|-----------------|---------------------|
| <b>GEV No.</b>     | 693276  | <b>Ref. No.</b> | 12023767<br>Z105012 |
| <b>description</b> | connector single DIN/ISO 08 B-1 splitting 1/2" links 1 L 23mm internal width 11.8mm rollerø 4.3mm metal   |                 |                     |
| <b>For models:</b> | ECO-160, ECO-1600, ECO-160D, ECO-160I, ECO-200, ECO-200D, ECO-200H, ECO-200HD, ECO-200HI, ECO-200I, ECO-2300, ECO-2700D, ECO-2700I, ECO-280D, ECO-280I, ECO-3000, ECO-370D, ECO-370I, ECO-4000D, ECO-4000I, ECO-460D, ECO-460I, ECO-550D, ECO-550I, ECO-6000D, ECO-6000I, FI-160, FI-1600, FI-160AR, FI-160D, FI-160I, FI-200, FI-200AR, FI-200D, FI-200H, FI-200HD, FI-200HI, FI-200I, FI-200W, FI-200WL, FI-200WR, FI-2300, FI-2700D, FI-2700I, FI-280D, FI-280I, FI-3000, FI-370D, FI-370I, FI-4000D...(Other models you can see in the webshop) |                 |                     |

### for hand blenders

#### couplings



|                    |   |                 |                        |
|--------------------|---|-----------------|------------------------|
| <b>GEV No.</b>     | 699275  | <b>Ref. No.</b> | 12032134<br>SAM4039060 |
| <b>description</b> | coupling set for hand blender shaft diameter 8mm D1 ø 17.5mm D2 ø 24mm int. ø 1 8mm int. ø 2 17mm L1 11.5mm L2 30mm |                 |                        |

### for cheese graters

#### miscellaneous



|                    |  |                 |                                |
|--------------------|--|-----------------|--------------------------------|
| <b>GEV No.</b>     | 110703   | <b>Ref. No.</b> | 12020819<br>T055434<br>T055440 |
| <b>description</b> | cylindrical handle thread M10 ø 28mm L 87mm      |                 |                                |
| <b>For models:</b> | BG7-05, BG7-10, BG9-05, BG9-05I, BG9-10, BG9-10I |                 |                                |



for fridges

spare parts and accessories



1

|                    |  |                 |                                      |
|--------------------|--|-----------------|--------------------------------------|
| <b>GEV No.</b>     | 700814   | <b>Ref. No.</b> | 12037835<br>6000202201<br>6003010020 |
| <b>description</b> | bracket for grate for fridge for refrigerated counters plastic   |                 |                                      |
| <b>For models:</b> | AEP-1402, AEP-1403, AEP-1404, AEP-1602, AEP-2103, AEP-701, AEP-702, AEP-801, AEP-802, AF-1402-MIX, AF-1403-C, AF-1403-P, AF-1404-C, AF-1404-P, AF-2104-C, AF-2104-P, AF-2105-C, AF-2105-P, AF-2106-C, AF-2106-P, AF-702-C, AF-702-P, AFN-1402, AFN-1403, AFN-1404, AFN-701, AFN-702, AFP-1402, AFP-1402-FORZ, AFP-1402-MIX, AFP-1403, AFP-1403-C, AFP-1403-FORZ, AFP-1403-P, AFP-1404, AFP-1404-C, AFP-1404-FORZ, AFP-1404-P, AFP-1404-USMC, AFP-2103, AFP-2104, AFP-2104-C, AFP-2104-P, AFP-2105, AFP-2105-C, AFP-2105-P, AFP-2106, AFP-2106-C, AFP-2106-P, AFP-701...(Other models you can see in the webshop) |                 |                                      |



2

|                    |                                    |                 |            |
|--------------------|------------------------------------|-----------------|------------|
| <b>GEV No.</b>     | 698845                             | <b>Ref. No.</b> | 6003010484 |
| <b>description</b> | protection cap L 15mm W 15mm H 4mm |                 |            |

housing and bezels



1

|                    |  |                 |                        |
|--------------------|--|-----------------|------------------------|
| <b>GEV No.</b>     | 691710   | <b>Ref. No.</b> | 12037397<br>6003010105 |
| <b>description</b> | front panel W 350mm H 80mm for fridge  |                 |                        |
| <b>For models:</b> | AEP-1402, AEP-1602, AEP-2103, AEP-701, AEP-801, AEP-802, AF-1402-MIX, AF-1403-C, AF-1403-P, AF-1404-C, AF-1404-P, AF-1602-MIX, AF-1603-C, AF-1603-P, AF-1604-C, AF-1604-P, AF-2104-C, AF-2104-P, AF-2105-C, AF-2105-P, AF-2106-C, AF-2106-P, AFN-1402, AFN-1403, AFN-1404, AFN-1602, AFN-1603, AFN-1604, AFN-702, AFN-801, AFN-802, AFP-1402, AFP-1403, AFP-1404, AFP-1602, AFP-1602-2, AFP-1603, AFP-1603-2, AFP-1604, AFP-2103, AFP-2104, AFP-2105, AFP-2106, AFP-701, AFP-702, AFP-801, AFP-802, AP-701, APP-701, FMP-150...(Other models you can see in the webshop) |                 |                        |

Зип-Общепит

drawers

drawers



1

|                    |  |                 |                        |
|--------------------|--|-----------------|------------------------|
| <b>GEV No.</b>     | 691842   | <b>Ref. No.</b> | 12030222<br>M177010070 |
| <b>description</b> | control panel L 635mm W 125mm  |                 |                        |
| <b>For models:</b> | MCP-147-GN-R, MFP-102-GN-R, MFP-147-GN-R, MFP-192-GN-R, MFP-237-GN-R, MSP-117-2RC, MSP-117-4RC, MSP-117-R, MSP-169-R, MSP-169-R2C, MSP-169-R4C, MSP-169-R6C, MSP-222-R, MSP-222-R4C, MSP-222-R6C, MSP-222-R8C, MSP-274-R, MSP-274-R10C |                 |                        |



1

|                    |                       |                 |                        |
|--------------------|-----------------------|-----------------|------------------------|
| <b>GEV No.</b>     | 691886                | <b>Ref. No.</b> | 12027259<br>M169120015 |
| <b>description</b> | drawer conversion kit |                 |                        |

vsezip.ru  
+7(812)987-08-81

Зип-Общепит

accessories

vsezip.ru

+7(812)987-08-81



1

|                    |                       |                 |                        |
|--------------------|-----------------------|-----------------|------------------------|
| <b>GEV No.</b>     | 691889                | <b>Ref. No.</b> | 12027330<br>M169120016 |
| <b>description</b> | drawer conversion kit |                 |                        |



1

|                    |   |                 |           |
|--------------------|---|-----------------|-----------|
| <b>GEV No.</b>     | 691850  | <b>Ref. No.</b> | 141911406 |
| <b>description</b> | drawer for deep freezer L 540mm W 530mm H 100mm |                 |           |



1

|                    |   |                 |                        |
|--------------------|---|-----------------|------------------------|
| <b>GEV No.</b>     | 691885  | <b>Ref. No.</b> | 12032484<br>M109050066 |
| <b>description</b> | drawer L 475mm W 400mm H 195mm  |                 |                        |
| <b>For models:</b> | CMSP-150HD, CMSP-150HH, CMSP-200HDD, CMSP-200HHD, CMSP-200HHH, CMSP-250HDDD, CMSP-250HHDD, CMSP-250HHHD, CMSP-250HHHH, MSP-117-2C, MSP-117-4C, MSP-117-R2C, MSP-117-R4C, MSP-150-2C, MSP-150-4C, MSP-169-2C, MSP-169-4C, MSP-169-6C, MSP-169-R2C, MSP-169-R4C, MSP-169-R6C, MSP-200-2C, MSP-200-4C, MSP-200-6C, MSP-222-2C, MSP-222-4C, MSP-222-6C, MSP-222-8C, MSP-222-R2C, MSP-222-R4C, MSP-222-R6C, MSP-222-R8C, MSP-250-2C, MSP-250-4C, MSP-250-6C, MSP-250-8C, MSP-274-10C, MSP-274-2C, MSP-274-4C, MSP-274-6C, MSP-274-8C, MSP-274-R10C, MSP-274-R6C, MSP-300-10C, MSP-300-2C, MSP-300-4C, MSP-300-6C, MSP-300-8C |                 |                        |

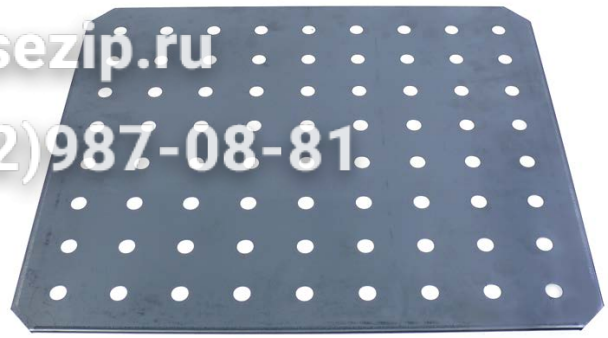

1

|   |  |                 |                                      |
|---|--|-----------------|--------------------------------------|
| <b>GEV No.</b>  | 691914   | <b>Ref. No.</b> | 12034642<br>6009990102<br>A109050103 |
| <b>description</b>  | bottom plate for fish drawer L 445mm W 380mm H 12mm  |                 |                                      |
| <b>For models:</b>  | AF-1403-P, AF-1404-P, AF-2104-P, AF-2105-P, AF-2106-P, AF-702-P, CAF-1403P, CAF-1404P, CAF-2104C, CAF-2105C, CAF-2106C, CAF-702P |                 |                                      |
| <b>accessories for</b>  | 691914   |                 |                                      |
|  | <b>GEV No.</b>   | 691903          | <b>Ref. No.</b> 141911404            |
|   | plastic insert drawer L 530mm W 460mm H 100mm fish   |                 |                                      |

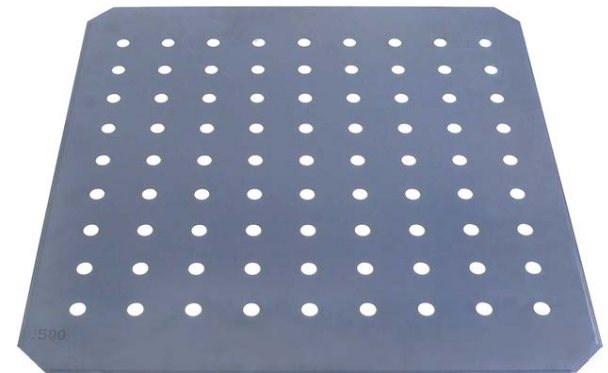

1

|   |   |                 |  |
|---|---|-----------------|--|
| <b>GEV No.</b>  | 691915  | <b>Ref. No.</b> | 12034466<br>12034707<br>6009990101<br>A109050143 |
| <b>description</b>  | bottom plate for fish drawer L 460mm W 480mm H 10mm               |                 |  |
| <b>For models:</b>  | AF-1603-P, AF-1604-P, AF-802-P, CAF-1603-P, CAF-1604-P, CAF-802-C |                 |  |
| <b>accessories for</b>  | 691915  |                 |  |
|  | <b>GEV No.</b>  | 691850          | <b>Ref. No.</b> 141911406                        |
|   | drawer for deep freezer L 540mm W 530mm H 100mm                   |                 |  |



Зип Общежит  
for blast chiller

vsezip.ru

+7(812)987-08-81



1

|   |   |                 |                                      |
|---|---|-----------------|--------------------------------------|
| <b>GEV No.</b>  | 691903  | <b>Ref. No.</b> | 141911404                            |
| <b>description</b>  | plastic insert drawer L 530mm W 460mm H 100mm fish  |                 |                                      |
| <b>accessories for</b>  | 691903  |                 |                                      |
|  | <b>GEV No.</b>                                      | 691914          | <b>Ref. No.</b>                      |
|   |   |                 | 12034642<br>6009990102<br>A109050103 |
|   | bottom plate for fish drawer L 445mm W 380mm H 12mm |                 |                                      |



1

|                    |   |                 |            |
|--------------------|---|-----------------|------------|
| <b>GEV No.</b>     | 698847  | <b>Ref. No.</b> | 6003010326 |
| <b>description</b> | drain pipe ø 40mm H 95mm 3/4"   |                 |            |
| <b>For models:</b> | ATM-051, ATM-051VCH, ATM-051VCH-60Hz, ATM-081VCH, ATM-081VCH-60Hz, ATM-101, ATM-101VCH, ATM-101VCH-60Hz, ATM-102, ATM-121VCH, ATM-121VCH-60Hz, ATM-121VCHP, ATM-161VCH, BFP-100A, BFP-100I, BFP-150A, BFP-150I, BFP-200A, BFP-200I, BFP-250A, BFP-250I, BFP-300I, FMP-117-R, FMP-150, FMP-150-TV, FMP-169-R, FMP-200, FMP-202, FMP-202-TV, FMP-222-R, FMP-250, FMP-255, FMP-255-TV, FMP-274-R, FMP-300, FMP-307, FMP-307-TV, MCN-135-GN, MCN-180-GN, MCN-270-GN, MCP-135-AD, MCP-135-GN, MCP-147-GN-R, MCP-180-AD, MCP-180-GN, MCP-192-GN-R, MCP-225-AD, MCP-225-GN, MCP-237-GN-R, MCP-270-GN...(Other models you can see in the webshop) |                 |            |

for upright freezers



1

|                    |   |                 |                        |
|--------------------|---|-----------------|------------------------|
| <b>GEV No.</b>     | 699342  | <b>Ref. No.</b> | 12037375<br>6003010184 |
| <b>description</b> | drip tray L 190mm W 50mm H 50mm   |                 |                        |
| <b>For models:</b> | AEP-1402, AEP-1602, AEP-2103, AEP-701, AEP-801, AEP-802, AF-1402-MIX, AF-1403-C, AF-1403-P, AF-1404-C, AF-1404-P, AF-1602-MIX, AF-1603-C, AF-1603-P, AF-1604-C, AF-1604-P, AF-2104-C, AF-2104-P, AF-2105-C, AF-2105-P, AF-2106-C, AF-2106-P, AF-702-C, AF-702-P, AF-802-C, AF-802-P, AFN-1402, AFN-1403, AFN-1404, AFN-1602, AFN-1603, AFN-1604, AFN-702, AFN-801, AFN-802, AFP-1402, AFP-1403, AFP-1404, AFP-1602, AFP-1602-2, AFP-1603, AFP-1603-2, AFP-1604, AFP-2103, AFP-2104, AFP-2105, AFP-2106, AFP-701, AFP-702, AFP-801...(Other models you can see in the webshop) |                 |                        |

for refrigerated counters

lid hinges



1

|                    |  |                 |  |
|--------------------|--|-----------------|--|
| <b>GEV No.</b>     | 695176   | <b>Ref. No.</b> | 12034284<br>12035092<br>6009990251<br>6033110003 |
| <b>description</b> | hinge stainless steel left/right set saladette |                 |  |
| <b>For models:</b> | MEP-100, MEP-135, MEP-180                      |                 |  |

spare parts and accessories



1

|                    |  |                 |                                      |
|--------------------|--|-----------------|--------------------------------------|
| <b>GEV No.</b>     | 700814   | <b>Ref. No.</b> | 12037835<br>6000202201<br>6003010020 |
| <b>description</b> | bracket for grate for fridge for refrigerated counters plastic   |                 |                                      |
| <b>For models:</b> | AEP-1402, AEP-1403, AEP-1404, AEP-1602, AEP-2103, AEP-701, AEP-702, AEP-801, AEP-802, AF-1402-MIX, AF-1403-C, AF-1403-P, AF-1404-C, AF-1404-P, AF-2104-C, AF-2104-P, AF-2105-C, AF-2105-P, AF-2106-C, AF-2106-P, AF-702-C, AF-702-P, AFN-1402, AFN-1403, AFN-1404, AFN-701, AFN-702, AFP-1402, AFP-1402-FORZ, AFP-1402-MIX, AFP-1403, AFP-1403-C, AFP-1403-FORZ, AFP-1403-P, AFP-1404, AFP-1404-C, AFP-1404-FORZ, AFP-1404-P, AFP-1404-USMC, AFP-2103, AFP-2104, AFP-2104-C, AFP-2104-P, AFP-2105, AFP-2105-C, AFP-2105-P, AFP-2106, AFP-2106-C, AFP-2106-P, AFP-701...(Other models you can see in the webshop) |                 |                                      |



1

|                    |   |                 |  |
|--------------------|---|-----------------|--|
| <b>GEV No.</b>     | 699229  | <b>Ref. No.</b> | 12037381<br>12037616<br>12061084<br>2061700015<br>6000202215<br>6003010034 |
| <b>description</b> | drain pipe H 29.5mm ø 29.5mm L 29.5mm   |                 |  |
| <b>For models:</b> | CMPP-117-R, CMPP-150, CMPP-150-C, CMPP-169-R, CMPP-202, CMPP-202-C, CMPP-222-R, CMPP-255, CMPP-255-C, CMPP-307, CMPZ1-135, CMPZ1-180, FMP-117-R, FMP-150, FMP-169-R, FMP-202, FMP-222-R, FMP-255, FMP-274-R, FMP-307, MCN-102-R, MCN-135, MCN-147-R, MCN-180, MCN-192-R, MCN-225, MCN-237-R, MCN-270, MCP-135, MCP-180, MCP-225, MCP-225-GN, MEP-135, MEP-135-GN, MEP-180, MEP-180-GN, MFN-102-R, MFN-135, MFN-147-R, MFN-180, MFN-192-R, MFN-225, MFN-237-R, MFN-270, MFP-102-2C, MFP-102-4C, MFP-135, MFP-135-2C, MFP-135-4C, MFP-135-F...(Other models you can see in the webshop) |                 |  |

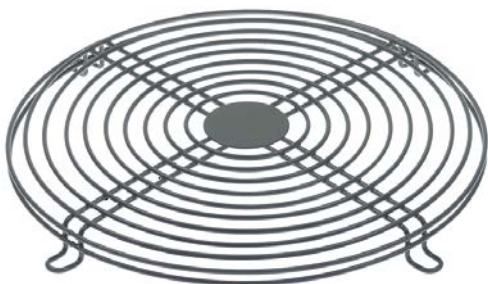

1

|                    |   |                 |                        |
|--------------------|---|-----------------|------------------------|
| <b>GEV No.</b>     | 692812  | <b>Ref. No.</b> | 12034663<br>6027130004 |
| <b>description</b> | guard for evaporator fan round ø 225mm mounting distance 235mm  |                 |                        |
| <b>For models:</b> | AEP-1402, AEP-1602, AEP-2103, AEP-701, AEP-801, AEP-802, AF-1402-MIX, AF-1403-C, AF-1403-P, AF-1404-C, AF-1404-P, AF-1602-MIX, AF-1603-C, AF-1603-P, AF-1604-C, AF-1604-P, AF-2104-C, AF-2104-P, AF-2105-C, AF-2105-P, AF-2106-C, AF-2106-P, AF-702-C, AF-702-P, AF-802-C, AF-802-P, AFN-1402, AFN-1403, AFN-1404, AFN-1602, AFN-1603, AFN-1604, AFN-701, AFN-702, AFN-801, AFN-802, AFP-1402, AFP-1403, AFP-1404, AFP-1602, AFP-1602-2, AFP-1603, AFP-1603-2, AFP-1604, AFP-2103, AFP-2104, AFP-2105, AFP-2106, AFP-701, AFP-702...(Other models you can see in the webshop) |                 |                        |



1

|                    |  |                 |                        |
|--------------------|--|-----------------|------------------------|
| <b>GEV No.</b>     | 699629   | <b>Ref. No.</b> | 12085225<br>M169090013 |
| <b>description</b> | mounting set for refrigerated counters FAGOR MPZ-1 |                 |                        |
| <b>For models:</b> | MPZ1-150, MPZ1-200, MPZ1-250                       |                 |                        |

Зип-Общепит

housing and sizes

vsezip.ru

+7(812)987-08-81



1

|                    |  |                 |                        |
|--------------------|--|-----------------|------------------------|
| <b>GEV No.</b>     | 210059   | <b>Ref. No.</b> | 12040457<br>M109250148 |
| <b>description</b> | cover for evaporator fan stainless steel W 400mm H 80mm L 415mm thickness 1mm  |                 |                        |
| <b>For models:</b> | CFMP-117-R, CFMP-117-RPC, CFMP-150, CFMP-150F, CFMP-150PC, CFMP-150TV, CFMP-169-R, CFMP-169-RPC, CFMP-202, CFMP-202F, CFMP-202PC, CFMP-202TV, CFMP-222-R, CFMP-222-RPC, CFMP-255, CFMP-255F, CFMP-255PC, CFMP-255TV, CFMP-307, CFMP-307F, CFMP-307TV, CMFN-102-R, CMFN-135, CMFN-147-R, CMFN-180, CMFP-102-R, CMFP-135, CMFP-135-B, CMFP-135-B2, CMFP-135-BP, CMFP-135F, CMFP-135-GR, CMFP-135HD, CMFP-135HH, CMFP-135PC, CMFP-147-R, CMFP-180, CMFP-180-B, CMFP-180-B2, CMFP-180-BP, CMFP-180F, CMFP-180-GR, CMFP-180HDD, CMFP-180HDD, CMFP-180HHH, CMFP-180PC, CMFP-192-R, CMFP-225, CMFP-225-B, CMFP-225-B2...(Other models you can see in the webshop) |                 |                        |



1

|                    |   |                 |                        |
|--------------------|---|-----------------|------------------------|
| <b>GEV No.</b>     | 691710  | <b>Ref. No.</b> | 12037397<br>6003010105 |
| <b>description</b> | front panel W 350mm H 80mm for fridge   |                 |                        |
| <b>For models:</b> | AEP-1402, AEP-1602, AEP-2103, AEP-701, AEP-801, AEP-802, AF-1402-MIX, AF-1403-C, AF-1403-P, AF-1404-C, AF-1404-P, AF-1602-MIX, AF-1603-C, AF-1603-P, AF-1604-C, AF-1604-P, AF-2104-C, AF-2104-P, AF-2105-C, AF-2105-P, AF-2106-C, AF-2106-P, AFN-1402, AFN-1403, AFN-1404, AFN-1602, AFN-1603, AFN-1604, AFN-701, AFN-702, AFN-801, AFN-802, AFP-1402, AFP-1403, AFP-1404, AFP-1602, AFP-1602-2, AFP-1603, AFP-1603-2, AFP-1604, AFP-2103, AFP-2104, AFP-2105, AFP-2106, AFP-701, AFP-702, AFP-801, AFP-802, AP-701, APP-701, FMP-150...(Other models you can see in the webshop) |                 |                        |



Зип Общепит

drawers

vsezip.ru

+7(812)987-08-81



|   |                    |  |                 |                        |
|---|--------------------|--|-----------------|------------------------|
| 1 | <b>GEV No.</b>     | 691844   | <b>Ref. No.</b> | 12032239<br>6039010009 |
|   | <b>description</b> | side panel H 224mm L 334mm mounting pos. right thickness 8mm     |                 |                        |
|   | <b>For models:</b> | MI-135, MI-150, MI-180, MI-202, MI-225, MI-255, MPZ-150, MPZ-202 |                 |                        |



|   |                    |   |                 |                        |
|---|--------------------|---|-----------------|------------------------|
| 1 | <b>GEV No.</b>     | 691922  | <b>Ref. No.</b> | 12031995<br>M169120021 |
|   | <b>description</b> | drawer front W 520mm H 430mm thickness 40mm with gasket |                 |                        |



|   |                    |  |                 |                        |
|---|--------------------|--|-----------------|------------------------|
| 1 | <b>GEV No.</b>     | 691845   | <b>Ref. No.</b> | 12031913<br>6039010010 |
|   | <b>description</b> | side panel H 224mm L 334mm thickness 8mm                         |                 |                        |
|   | <b>For models:</b> | MI-135, MI-150, MI-180, MI-202, MI-225, MI-255, MPZ-150, MPZ-202 |                 |                        |



|   |                    |   |                 |                        |
|---|--------------------|---|-----------------|------------------------|
| 1 | <b>GEV No.</b>     | 694198  | <b>Ref. No.</b> | 12033303<br>M169120024 |
|   | <b>description</b> | drawer front with gasket W 440mm H 428mm thickness 40mm |                 |                        |





|   |                    |  |                 |                        |
|---|--------------------|--|-----------------|------------------------|
| 1 | <b>GEV No.</b>     | 505326   | <b>Ref. No.</b> | 12037176<br>6023010064 |
|   | <b>description</b> | sticker FAGOR L 108mm W 33mm ø 2mm   |                 |                        |
|   | <b>For models:</b> | MFP-135-B, MFP-180-B, MFP-225-B, MFP-270-B, MMC-100, MMC-150, MMC-200, MMC-250 |                 |                        |

## doors



1

|   |   |                 |  |
|---|---|-----------------|--|
| <b>GEV No.</b>  | 694309  | <b>Ref. No.</b> | 12030565<br>M169010084                 |
| <b>description</b>  | door W 630mm H 435mm thickness 40mm   |                 |  |
| <b>accessories for</b>  | 694309  |                 |  |
|    | <b>GEV No.</b>  | 690763          | <b>Ref. No.</b> 12038130<br>6033010100 |
|   | spring assisted hinge right/left L 111mm W 75mm refrigerator mounting distance 25mm |                 |  |
|   | <b>GEV No.</b>  | 690764          | <b>Ref. No.</b> 12037723<br>6003010136 |
|   | bush W 23.5mm H 53.5mm mounting pos. upper/lower ø 16mm ID ø 10mm grey for hinge    |                 |  |
|  | <b>GEV No.</b>  | 901164          | <b>Ref. No.</b> 12038156<br>6045010119 |
|   | refrigeration gasket profile 9797 W 365mm L 560mm plug size                         |                 |  |

## worktops

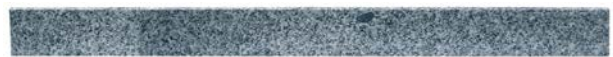

1

|                    |  |                 |                        |
|--------------------|--|-----------------|------------------------|
| <b>GEV No.</b>     | 691905   | <b>Ref. No.</b> | 12033431<br>6031010028 |
| <b>description</b> | side panel granite L 1460mm W 120mm thickness 20mm Qty 1 pcs |                 |                        |
| <b>For models:</b> | MMZ-150, MPZ-150   |                 |                        |



1

|                    |   |                 |                        |
|--------------------|---|-----------------|------------------------|
| <b>GEV No.</b>     | 691894  | <b>Ref. No.</b> | 12034667<br>6031010026 |
| <b>description</b> | side panel Qty 2 pcs granite L 800mm W 120mm thickness 20mm |                 |                        |
| <b>For models:</b> | MMZ-150, MMZ-202, MPZ-150, MPZ-202                          |                 |                        |

## ЗипОбщепит

for freezer cabinets

## doors

vsezip.ru

+7(812)987-08-81



1

|                    |   |                 |  |
|--------------------|---|-----------------|--|
| <b>GEV No.</b>     | 650104                                      | <b>Ref. No.</b> | 12031769<br>12035085<br>12045302<br>6009990015<br>6031030001 |
| <b>description</b> | lid for beverage refrigerator               |                 |  |
| <b>For models:</b> | BFP-100, BFP-150, BFP-200, BFP-250, BFP-300 |                 |  |

## for display coolers

## housing and bezels

## side parts



1

|                    |  |                 |                        |
|--------------------|--|-----------------|------------------------|
| <b>GEV No.</b>     | 691846                                       | <b>Ref. No.</b> | 12035234<br>6003010171 |
| <b>description</b> | side panel L 408mm thickness 20mm H 245mm    |                 |                        |
| <b>For models:</b> | VTP-139-C, VTP-139-RC, VTP-175-C, VTP-175-RC |                 |                        |



1

|                    |   |                 |                        |
|--------------------|---|-----------------|------------------------|
| <b>GEV No.</b>     | 694071  | <b>Ref. No.</b> | 12034937<br>6003010170 |
| <b>description</b> | side panel mounting pos. left W 410mm H 245mm for tapas display |                 |                        |
| <b>For models:</b> | VTP-139-C, VTP-175-C  |                 |                        |



3ип Общепит  
for ice-cube maker

drain systems  
overflow pipes

+7(812)987-08-81



1

|                    |  |                 |                        |
|--------------------|--|-----------------|------------------------|
| <b>GEV No.</b>     | 694072   | <b>Ref. No.</b> | 12035148<br>6003010172 |
| <b>description</b> | side panel mounting pos. right W 410mm H 245mm for tapas display |                 |                        |
| <b>For models:</b> | VTP-139-P, VTP-139-RP, VTP-175-P, VTP-175-RP                     |                 |                        |



1

|                        |  |                 |                       |
|------------------------|--|-----------------|-----------------------|
| <b>GEV No.</b>         | 695622   | <b>Ref. No.</b> | 12037650<br>B00010305 |
| <b>description</b>     | lid for overflow pipe tube ø 34mm              |                 |                       |
| <b>accessories for</b> | 695622   |                 |                       |
| <b>GEV No.</b>         | 695086   | <b>Ref. No.</b> | —                     |
| <b>description</b>     | overflow pipe tube ø 20.5mm pipe length 88.6mm |                 |                       |

glass panels

glass panels

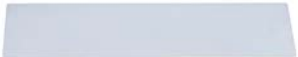

1

|                    |  |                 |  |
|--------------------|--|-----------------|--|
| <b>GEV No.</b>     | 700839                                       | <b>Ref. No.</b> | 12031917<br>12035036<br>6002101007<br>6035050012 |
| <b>description</b> | glass panel L 725mm W 165mm thickness 3mm    |                 |  |
| <b>For models:</b> | VTP-175-C, VTP-175-CD, VTP-175-P, VTP-175-PD |                 |  |

doors

doors



1

|                    |  |                 |          |
|--------------------|--|-----------------|----------|
| <b>GEV No.</b>     | 695514   | <b>Ref. No.</b> | 12038019 |
| <b>description</b> | door for ice-cube maker W 447mm H 217mm thickness 22mm |                 |          |

doors



1

|                    |  |                 |                        |
|--------------------|--|-----------------|------------------------|
| <b>GEV No.</b>     | 694196                                       | <b>Ref. No.</b> | 12035230<br>6035050006 |
| <b>description</b> | door W 550mm H 166mm glas thickness 3mm      |                 |                        |
| <b>For models:</b> | VTP-139-C, VTP-139-CD, VTP-139-P, VTP-139-PD |                 |                        |

curtains

with holder



1

|                    |  |                 |                        |
|--------------------|--|-----------------|------------------------|
| <b>GEV No.</b>     | 695507   | <b>Ref. No.</b> | 12033184<br>BR00C22035 |
| <b>description</b> | curtain for ice maker W 433mm H 165mm with holder shaft length 438mm shaft ø 7.5mm |                 |                        |

door mechanics

miscellaneous



1

|                    |   |                 |                        |
|--------------------|---|-----------------|------------------------|
| <b>GEV No.</b>     | 700811  | <b>Ref. No.</b> | 12035982<br>E107090005 |
| <b>description</b> | balance weight for sliding door L 400mm W 25mm H 15mm |                 |                        |

floats

float containers



1

|                    |  |                 |                        |
|--------------------|--|-----------------|------------------------|
| <b>GEV No.</b>     | 695072   | <b>Ref. No.</b> | 12030020<br>BR00C10201 |
| <b>description</b> | float container for ice maker with microswitch plastic |                 |                        |

## for espresso machines

## brewing units

## filter holder gaskets

## O-rings



1

|                    |   |                 |                     |
|--------------------|---|-----------------|---------------------|
| <b>GEV No.</b>     | 510409  | <b>Ref. No.</b> | 12010040<br>Q307044 |
| <b>description</b> | O-ring EPDM thickness 5.34mm ID ø 56.52mm Qty 1 pcs   |                 |                     |
| <b>For models:</b> | ECO-160, ECO-1600, ECO-160D, ECO-160I, ECO-200, ECO-200D, ECO-200H, ECO-200HD, ECO-200HI, ECO-200I, ECO-2300, ECO-2700D, ECO-2700I, ECO-280D, ECO-280I, ECO-3000, ECO-370D, ECO-370I, ECO-4000D, ECO-4000I, ECO-460D, ECO-460I, ECO-550D, ECO-550I, ECO-6000D, ECO-6000I, FI-160, FI-1600, FI-160AR, FI-160D, FI-160I, FI-200, FI-200AR, FI-200D, FI-200H, FI-200HD, FI-200HI, FI-200I, FI-200W, FI-200WL, FI-200WR, FI-2300, FI-2700D, FI-2700I, FI-280D, FI-280I, FI-3000, FI-370D, FI-370I, FI-4000D...(Other models you can see in the webshop) |                 |                     |

## intake valves

## accessories

## miscellaneous



1

|                    |               |                 |                     |
|--------------------|---------------|-----------------|---------------------|
| <b>GEV No.</b>     | 528422        | <b>Ref. No.</b> | 12039801<br>Z605922 |
| <b>description</b> | ball ø 8mm SS |                 |                     |

## for bain marie

## spare parts and accessories



1

|                    |   |                 |          |
|--------------------|---|-----------------|----------|
| <b>GEV No.</b>     | 691650  | <b>Ref. No.</b> | 12019228 |
| <b>description</b> | connecting fitting brass L 52mm W 30mm H 30mm |                 |          |



1

|                    |  |                 |          |
|--------------------|--|-----------------|----------|
| <b>GEV No.</b>     | 691651   | <b>Ref. No.</b> | 12020990 |
| <b>description</b> | threaded part brass L 27mm ID ø 12.4mm thread 1/2" |                 |          |

## Зип Общежит housing and bezels

vsezip.ru

+7(812)987-08-81

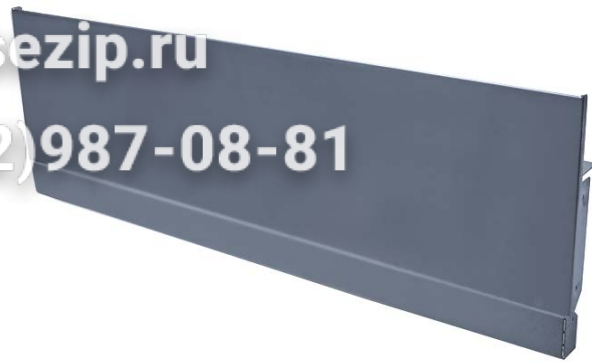

1

|                    |  |                 |                     |
|--------------------|--|-----------------|---------------------|
| <b>GEV No.</b>     | 691722   | <b>Ref. No.</b> | 12004214<br>R062811 |
| <b>description</b> | back panel chargrill   |                 |                     |
| <b>For models:</b> | BG9-05AD, BG9-05PF, BG9-05PI, BG9-05PLUS-I, BG9-10AD, BG9-10PF, BG9-10PI, BG9-10PLUS-I, BME9-05, BME9-05AD, BME9-05PLUS, BME9-05V-T, BME9-10, BME9-10AD, BME9-10PLUS, BME9-10V-T, BMG9-05, BMG9-05V-T, BMG9-10, BMG9-10V-T, CE9-20, CE9-20AD, CE9-20PLUS, CE9-40, CE9-40AD, CE9-40PLUS, CG9-05AD, CG9-05PLUS, CG9-10, CG9-10AD, CG9-10PLUS, CG9-20, CG9-20AD, CG9-20AD-H, CG9-20H, CG9-20PLUS, CG9-20PLUS-H, CG9-40, CG9-40AD, CG9-40AD-H, CG9-40H, CG9-40PLUS, CG9-40PLUS-H, CG9-60, CG9-60AD, CG9-60AD-H, CG9-60H, CG9-60PLUS, CG9-60PLUS-H, CGF9-120D...(Other models you can see in the webshop) |                 |                     |



1

|                    |                           |                 |                     |
|--------------------|---------------------------|-----------------|---------------------|
| <b>GEV No.</b>     | 691708                    | <b>Ref. No.</b> | 12014063<br>R982802 |
| <b>description</b> | back panel for bain marie |                 |                     |
| <b>For models:</b> | BME7-10, BMG7-10          |                 |                     |



1

|                    |                      |                 |                     |
|--------------------|----------------------|-----------------|---------------------|
| <b>GEV No.</b>     | 691712               | <b>Ref. No.</b> | 12013779<br>R966105 |
| <b>description</b> | cover for bain marie |                 |                     |
| <b>For models:</b> | BME7-05              |                 |                     |



Зип Общепит

vsezip.ru

+7(812)987-08-81





1

|   |   |                 |                     |
|---|---|-----------------|---------------------|
| <b>GEV No.</b>  | 210022  | <b>Ref. No.</b> | 12020193<br>U452805 |
| <b>description</b>  | cover L 177mm W 52mm H 16mm for control panel mounting pos. left suitable for 700 series  |                 |                     |
| <b>For models:</b>  | BG7-05, BG7-05I, BG7-10, BG7-10I, BME7-05, BME7-10, BMG7-10, CE7-20, CE7-40, CE7-41, CG7-10, CG7-11, CG7-20, CG-7200, CG7-40, CG-7400, CG7-41, CG-7415, CG7-61, CG-7615, CGB7-61, CGE7-41, CGE7-69, CPG7-05, EN7-05, EN7-10, FE-710, FE-720, FG-710, FG-720, FTE7-05, FTE7-05L, FTE7-05R, FTE7-10, FTE7-10L, FTE7-10L+R, FTE7-10R, FTEC7-05L, FTEC7-10L, FTG7-05, FTG7-05L, FTG7-05R, FTG7-05VL, FTG7-05VR, FTG7-10, FTG7-10L, FTG7-10L+R, FTG7-10R, FTG7-10VL, FTG7-10VL+R...(Other models you can see in the webshop) |                 |                     |
| <b>accessories for</b>  | 210022  |                 |                     |
|  | <b>GEV No.</b>  | 210021          | <b>Ref. No.</b>     |
|   |   |                 | 12020194<br>U452804 |
|   | cover L 177mm W 52mm H 16mm for control panel mounting pos. right suitable for 700 series   |                 |                     |



1

|   |   |                 |                     |
|---|---|-----------------|---------------------|
| <b>GEV No.</b>  | 210021  | <b>Ref. No.</b> | 12020194<br>U452804 |
| <b>description</b>  | cover L 177mm W 52mm H 16mm for control panel mounting pos. right suitable for 700 series   |                 |                     |
| <b>For models:</b>  | BG7-05, BG7-05I, BG7-10, BG7-10I, BME7-05, BME7-10, BMG7-10, CE7-20, CE7-40, CE7-41, CG7-10, CG7-11, CG7-20, CG-7200, CG7-40, CG-7400, CG7-41, CG-7415, CG7-61, CG-7615, CGB7-61, CGE7-41, CGE7-62, CPG7-05, EN7-05, EN7-10, FE-710, FE-720, FG-710, FG-720, FTE7-05, FTE7-05L, FTE7-05R, FTE7-10, FTE7-10L, FTE7-10L+R, FTE7-10R, FTEC7-05L, FTEC7-10L, FTG7-05, FTG7-05L, FTG7-05R, FTG7-05VL, FTG7-05VR, FTG7-10, FTG7-10L, FTG7-10L+R, FTG7-10R, FTG7-10VL, FTG7-10VL+R...(Other models you can see in the webshop) |                 |                     |
| <b>accessories for</b>  | 210021  |                 |                     |
|  | <b>GEV No.</b>  | 210022          | <b>Ref. No.</b>     |
|   |   |                 | 12020193<br>U452805 |
|   | cover L 177mm W 52mm H 16mm for control panel mounting pos. left suitable for 700 series  |                 |                     |



1

|                    |  |                 |                     |
|--------------------|--|-----------------|---------------------|
| <b>GEV No.</b>     | 700809   | <b>Ref. No.</b> | 12007564<br>R205409 |
| <b>description</b> | fastening angle L 120mm W 67mm H 28mm  |                 |                     |
| <b>For models:</b> | BG9-05, BG9-10, BME9-05, BME9-10, BMG9-05, BMG9-10, CE9-20, CE9-40, CE9-41, CG9-10, CG9-11, CG9-20, CG9-40, CG9-41, CG9-60, CG9-61, CG9-82, EN9-05, EN9-10, FE-920, FG-920, FG-940, FTE9-05L, FTE9-05R, FTE9-10L, FTE9-10L+R, FTE9-10R, FTEC9-05, FTEC9-05L, FTEC9-05R, FTEC9-10, FTEC9-10L, FTEC9-10L+R, FTEC9-10R, FTG9-05L, FTG9-05R, FTG9-05VL, FTG9-05VR, FTG9-10L, FTG9-10L+R, FTG9-10R, FTG9-10VL, FTG9-10VL+R, FTG9-10VR, FTGC9-05, FTGC9-05L, FTGC9-05R, FTGC9-10, FTGC9-10L, FTGC9-10L+R...(Other models you can see in the webshop) |                 |                     |

1

Reglado a BUTANO-PROPANO  
Reglage BUTANE-PROPANE  
Regulated for L.P.G. using

|                    |  |                 |                     |
|--------------------|--|-----------------|---------------------|
| <b>GEV No.</b>     | 691735   | <b>Ref. No.</b> | 12008203<br>U136501 |
| <b>description</b> | sticker Regulated for L.P.G. using   |                 |                     |
| <b>For models:</b> | BG7-05, BG7-05I, BG7-10, BG7-10I, BG9-05, BG9-05I, BG9-05PF, BG9-05PI, BG9-10, BG9-10I, BG9-10PF, BG9-10PI, BME9-05, BME9-05V-T, BME9-10, BME9-10V-T, BMG7-10, BMG9-05, BMG9-05V-T, BMG9-10, BMG9-10V-T, CG-1002, CG-1502, CG-2000, CG-2005, CG-210, CG-210G, CG-300S, CG-310, CG-310G, CG7-10, CG7-11, CG-7115, CG7-20, CG-7200, CG7-20H, CG7-30D, CG7-30I, CG7-31D, CG7-31I, CG7-40, CG-7400, CG7-40H, CG7-41, CG-7415, CG7-41H, CG7-50, CG7-51, CG7-61, CG-7615...(Other models you can see in the webshop) |                 |                     |

1

Reglado a GAS NATURAL  
Reglage GAZ NATUREL  
Regulated for NATURAL GAS using

|                    |   |                 |                     |
|--------------------|---|-----------------|---------------------|
| <b>GEV No.</b>     | 691736  | <b>Ref. No.</b> | 12008202<br>U134402 |
| <b>description</b> | sticker regulated for NATURAL GAS using   |                 |                     |
| <b>For models:</b> | BG7-05, BG7-05I, BG7-10, BG7-10I, BG9-05, BG9-05I, BG9-05PF, BG9-05PI, BG9-10, BG9-10I, BG9-10PF, BG9-10PI, BME9-05, BME9-05V-T, BME9-10, BME9-10V-T, BMG7-10, BMG-9045, BMG9-05, BMG9-05V-T, BMG9-10, BMG9-10V-T, CG-1002, CG-1502, CG-2000, CG-2005, CG-210, CG-210G, CG-300S, CG-310, CG-310G, CG7-10, CG7-11, CG-7115, CG7-20, CG-7200, CG7-20H, CG7-30D, CG7-30I, CG7-31D, CG7-31I, CG7-40, CG-7400, CG7-40H, CG7-41, CG-7415, CG7-41H, CG7-50, CG7-51, CG7-61...(Other models you can see in the webshop) |                 |                     |

Зип Общежит

housing and covers

vsezip.ru

+7(812)987-08-81



1

|                    |   |                 |  |
|--------------------|---|-----------------|--|
| <b>GEV No.</b>     | 691691  | <b>Ref. No.</b> | 12009010<br>12009015<br>U022836<br>U262806 |
| <b>description</b> | type plate FAGOR metal  |                 |  |
| <b>For models:</b> | BG6-05I, BG7-05, BG7-05I, BG7-10, BG7-10I, BG9-05, BG9-05AD, BG9-05I, BG9-05PF, BG9-05PI, BG9-05PLUS-I, BG9-10, BG9-10AD, BG9-10I, BG9-10PF, BG9-10PI, BG9-10PLUS-I, BME6-05, BME7-05, BME7-10, BME9-05, BME9-05AD, BME9-05PLUS, BME9-05V-T, BME9-10, BME9-10AD, BME9-10PLUS, BME9-10V-T, BMG7-10, BMG9-05, BMG9-05V-T, BMG9-10, BMG9-10V-T, CE6-20, CE6-40, CE6-41, CE7-20, CE7-40, CE7-41, CE9-20, CE9-20AD, CE9-20PLUS, CE9-40, CE9-40AD, CE9-40PLUS, CE9-41, CE9-41AD, CE9-41PLUS, CG-1002, CG-1502...(Other models you can see in the webshop) |                 |  |

## for deep fryers

## lids



1

|                    |  |                 |                     |
|--------------------|--|-----------------|---------------------|
| <b>GEV No.</b>     | 691685                                       | <b>Ref. No.</b> | 12004790<br>X352825 |
| <b>description</b> | cover suitable for fryer L 297mm W 175mm FE4 |                 |                     |
| <b>For models:</b> | FE-4   |                 |                     |



1

|                    |  |                 |                     |
|--------------------|--|-----------------|---------------------|
| <b>GEV No.</b>     | 691722   | <b>Ref. No.</b> | 12004214<br>R062811 |
| <b>description</b> | back panel chargrill   |                 |                     |
| <b>For models:</b> | BG9-05AD, BG9-05PF, BG9-05PI, BG9-05PLUS-I, BG9-10AD, BG9-10PF, BG9-10PI, BG9-10PLUS-I, BME9-05, BME9-05AD, BME9-05PLUS, BME9-05V-T, BME9-10, BME9-10AD, BME9-10PLUS, BME9-10V-T, BMG9-05, BMG9-05V-T, BMG9-10, BMG9-10V-T, CE9-20, CE9-20AD, CE9-20PLUS, CE9-40, CE9-40AD, CE9-40PLUS, CG9-05AD, CG9-05PLUS, CG9-10, CG9-10AD, CG9-10PLUS, CG9-20, CG9-20AD, CG9-20AD-H, CG9-20H, CG9-20PLUS, CG9-20PLUS-H, CG9-40, CG9-40AD, CG9-40AD-H, CG9-40H, CG9-40PLUS, CG9-40PLUS-H, CG9-60, CG9-60AD, CG9-60AD-H, CG9-60H, CG9-60PLUS, CG9-60PLUS-H, CGF9-120D...(Other models you can see in the webshop) |                 |                     |



1

|                    |                                |                 |         |
|--------------------|--------------------------------|-----------------|---------|
| <b>GEV No.</b>     | 700808                         | <b>Ref. No.</b> | X330504 |
| <b>description</b> | fastening angle for door hinge |                 |         |



1

|                    |  |                 |                     |
|--------------------|--|-----------------|---------------------|
| <b>GEV No.</b>     | 700809   | <b>Ref. No.</b> | 12007564<br>R205409 |
| <b>description</b> | fastening angle L 120mm W 67mm H 28mm  |                 |                     |
| <b>For models:</b> | BG9-05, BG9-10, BME9-05, BME9-10, BMG9-05, BMG9-10, CE9-20, CE9-40, CE9-41, CG9-10, CG9-11, CG9-20, CG9-40, CG9-41, CG9-60, CG9-61, CG9-82, EN9-05, EN9-10, FE-920, FG-920, FG-940, FTE9-05L, FTE9-05R, FTE9-10L, FTE9-10L+R, FTE9-10R, FTEC9-05, FTEC9-05L, FTEC9-05R, FTEC9-10, FTEC9-10L, FTEC9-10L+R, FTEC9-10R, FTG9-05L, FTG9-05R, FTG9-05VL, FTG9-05VR, FTG9-10L, FTG9-10L+R, FTG9-10R, FTG9-10VL, FTG9-10VL+R, FTG9-10VR, FTGC9-05, FTGC9-05L, FTGC9-05R, FTGC9-10, FTGC9-10L, FTGC9-10L+R...(Other models you can see in the webshop) |                 |                     |





Зип Общепит  
vsezip.ru  
+7(812)987-08-81



1

|                    |                                       |                 |                     |
|--------------------|---------------------------------------|-----------------|---------------------|
| <b>GEV No.</b>     | 691718                                | <b>Ref. No.</b> | 12014050<br>X332800 |
| <b>description</b> | front panel for fryer W 700mm H 175mm |                 |                     |
| <b>For models:</b> | FE-720, FG-720                        |                 |                     |

Reglado a BUTANO-PROPANO  
Reglage BUTANE-PROPANE  
Regulated for L.P.G. using

|                    |  |                 |                     |
|--------------------|--|-----------------|---------------------|
| <b>GEV No.</b>     | 691735   | <b>Ref. No.</b> | 12008203<br>U136501 |
| <b>description</b> | sticker Regulated for L.P.G. using   |                 |                     |
| <b>For models:</b> | BG7-05, BG7-05I, BG7-10, BG7-10I, BG9-05, BG9-05I, BG9-05PF, BG9-05PI, BG9-10, BG9-10I, BG9-10PF, BG9-10PI, BME9-05, BME9-05V-T, BME9-10, BME9-10V-T, BMG7-10, BMG9-05, BMG9-05V-T, BMG9-10, BMG9-10V-T, CG-1002, CG-1502, CG-2000, CG-2005, CG-210, CG-210G, CG-3005, CG-310, CG-310G, CG7-10, CG7-11, CG-7115, CG7-20, CG-7200, CG7-20H, CG7-30D, CG7-30I, CG7-31D, CG7-31I, CG7-40, CG-7400, CG7-40H, CG7-41, CG-7415, CG7-41H, CG7-50, CG7-51, CG7-61, CG-7615...(Other models you can see in the webshop) |                 |                     |

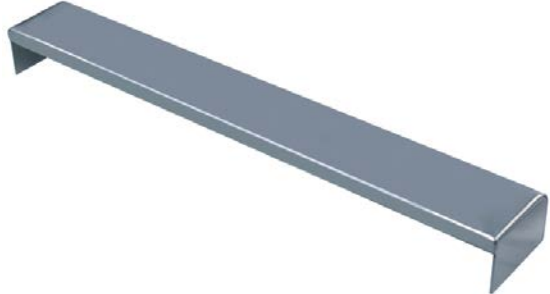

1

|                    |                                  |                 |            |
|--------------------|----------------------------------|-----------------|------------|
| <b>GEV No.</b>     | 506169                           | <b>Ref. No.</b> | FAG6000005 |
| <b>description</b> | front panel W 400mm H 60mm fryer |                 |            |

Reglado a GAS NATURAL  
Reglage GAZ NATUREL  
Regulated for NATURAL GAS using

|                    |   |                 |                     |
|--------------------|---|-----------------|---------------------|
| <b>GEV No.</b>     | 691736  | <b>Ref. No.</b> | 12008202<br>U134402 |
| <b>description</b> | sticker regulated for NATURAL GAS using   |                 |                     |
| <b>For models:</b> | BG7-05, BG7-05I, BG7-10, BG7-10I, BG9-05, BG9-05I, BG9-05PF, BG9-05PI, BG9-10, BG9-10I, BG9-10PF, BG9-10PI, BME9-05, BME9-05V-T, BME9-10, BME9-10V-T, BMG7-10, BMG-9045, BMG9-05, BMG9-05V-T, BMG9-10, BMG9-10V-T, CG-1002, CG-1502, CG-2000, CG-2005, CG-210, CG-210G, CG-3005, CG-310, CG-310G, CG7-10, CG7-11, CG-7115, CG7-20, CG-7200, CG7-20H, CG7-30D, CG7-30I, CG7-31D, CG7-31I, CG7-40, CG-7400, CG7-40H, CG7-41, CG-7415, CG7-41H, CG7-50, CG7-51, CG7-61...(Other models you can see in the webshop) |                 |                     |



1

|                    |   |                 |                     |
|--------------------|---|-----------------|---------------------|
| <b>GEV No.</b>     | 104123  | <b>Ref. No.</b> | 12013999<br>U742640 |
| <b>description</b> | mounting plate for gas range L 690mm W 110mm H 25mm                       |                 |                     |
| <b>For models:</b> | CE7-41, CG7-11, CG7-41, CGE7-41, FE-720, FG-720, MB7-10, MG7-10, MG7-10BM |                 |                     |



1

|                    |  |                 |                     |
|--------------------|--|-----------------|---------------------|
| <b>GEV No.</b>     | 550771   | <b>Ref. No.</b> | 12004055<br>X163022 |
| <b>description</b> | terminal box L 170mm W 150mm H 70mm for thermostat   |                 |                     |
| <b>For models:</b> | FG9-05, FG9-05-1C, FG9-05-2C, FG9-10, FG9-10-2C, FG9-10-4C, FGCL9-05, FGCL9-05-1C, FGCL9-05-2C |                 |                     |

Зип.Общепит

sumps

vsezip.ru

GEV

+7(812)987-08-81

1

|                    |  |                 |   |
|--------------------|--|-----------------|---|
| <b>GEV No.</b>     | 691892                                   | <b>Ref. No.</b> | 1100002846<br>1100002848<br>12038270<br>12038338<br>X316100 |
| <b>description</b> | sump for fryer suitable for FAGOR FG7-00 |                 |   |
| <b>For models:</b> | FG-710, FG-720                           |                 |   |



|                    |  |                 |                                   |
|--------------------|--|-----------------|-----------------------------------|
| <b>GEV No.</b>     | 691893                                   | <b>Ref. No.</b> | 1100002845<br>12038344<br>X166124 |
| <b>description</b> | sump for fryer suitable for FAGOR FG9-00 |                 |                                   |

1

|                    |  |                 |                                   |
|--------------------|--|-----------------|-----------------------------------|
| <b>GEV No.</b>     | 691893                                   | <b>Ref. No.</b> | 1100002845<br>12038344<br>X166124 |
| <b>description</b> | sump for fryer suitable for FAGOR FG9-00 |                 |                                   |

## for grills

## spare parts and accessories



|                    |                               |                 |                     |
|--------------------|-------------------------------|-----------------|---------------------|
| <b>GEV No.</b>     | 691853                        | <b>Ref. No.</b> | 12011165<br>T035473 |
| <b>description</b> | bracket L 480mm H 45mm W 20mm |                 |                     |

1

|                    |                               |                 |                     |
|--------------------|-------------------------------|-----------------|---------------------|
| <b>GEV No.</b>     | 691853                        | <b>Ref. No.</b> | 12011165<br>T035473 |
| <b>description</b> | bracket L 480mm H 45mm W 20mm |                 |                     |



1

|                    |   |                 |  |
|--------------------|---|-----------------|--|
| <b>GEV No.</b>     | 691691  | <b>Ref. No.</b> | 12009010<br>12009015<br>U022836<br>U262806 |
| <b>description</b> | type plate FAGOR metal  |                 |  |
| <b>For models:</b> | BG6-05I, BG7-05, BG7-05I, BG7-10, BG7-10I, BG9-05, BG9-05AD, BG9-05I, BG9-05PF, BG9-05PI, BG9-05PLUS-I, BG9-10, BG9-10AD, BG9-10I, BG9-10PF, BG9-10PI, BG9-10PLUS-I, BME6-05, BME7-05, BME7-10, BME9-05, BME9-05AD, BME9-05PLUS, BME9-05V-T, BME9-10, BME9-10AD, BME9-10PLUS, BME9-10V-T, BMG7-10, BMG9-05, BMG9-05V-T, BMG9-10, BMG9-10V-T, CE6-20, CE6-40, CE6-41, CE7-20, CE7-40, CE7-41, CE9-20, CE9-20AD, CE9-20PLUS, CE9-40, CE9-40AD, CE9-40PLUS, CE9-41, CE9-41AD, CE9-41PLUS, CG-1002, CG-1502...(Other models you can see in the webshop) |                 |  |

## glass panels



1

|                    |  |                 |                     |
|--------------------|--|-----------------|---------------------|
| <b>GEV No.</b>     | 692158   | <b>Ref. No.</b> | 12008981<br>9294600 |
| <b>description</b> | glass panel ø 29.5mm thickness 5mm   |                 |                     |
| <b>For models:</b> | FE-18, FE-25, FGCL9-05, MG7-10, MG7-10BM, MG9-10, MG9-10AD, MG9-10BM, MG9-10BMAD, MG9-10BMS, MG9-10BMSAD, MG9-10PLUS, MG9-10PLUS-BM, MG9-10PLUS-BMS, MG9-10PLUS-S, MG9-10S, MG9-10S-AD, MG9-15, MG-9150BM, MG9-15AD, MG9-15BM, MG9-15BM316, MG9-15BMAD, MG9-15BMS, MG9-15BMSAD, MG9-15PLUS, MG9-15PLUS-BM, MG9-15PLUS-BMS, MG9-15PLUS-S, MG9-15S, MG9-15S-AD, MG9-20, MG9-20AD, MG9-20PLUS, MG9-20PLUS-S, MG9-20S, MG9-20S-AD, MPG9-10, MPG9-10BM, MPG9-10BMS, MPG9-10S, MPG9-15, MPG9-15BM, MPG9-15BMS, MPG9-15S, MPG9-20, MPG9-20S |                 |                     |

## door magnets



1

|                    |   |                 |                     |
|--------------------|---|-----------------|---------------------|
| <b>GEV No.</b>     | 691000  | <b>Ref. No.</b> | 12009033<br>X960501 |
| <b>description</b> | door magnet ø 32mm H 7mm M4   |                 |                     |
| <b>For models:</b> | CG-310, CG-310G, CG7-51, CG7-61, CG7-61H, CG9-41H, CG9-51L, CG9-51LC, CG9-51R, CG9-51RC, CG9-61, CG9-61H, CGF9-121D, CGF9-121D-AD, CGF9-121I, CGF9-121I-AD, CGF9-121PLUS-D, CGF9-121PLUS-I, CPE7-05, CPE7-05NC, CPE9-05, CPE9-05AD, CPE9-05AD-S, CPE9-05NC, CPE9-05PLUS, CPE9-05PLUS-S, CPE9-05S, CPE9-05SNC, CPG7-05, CPG7-05NC, CPG9-05, CPG9-05AD, CPG9-05AD-S, CPG9-05NC, CPG9-05PLUS, CPG9-05PLUS-S, CPG9-05S, CPG9-05SNC, EPC-350, FE-18, FE-25, FE7-05-1C, FE7-05-2C, FE-710, FE7-10-2C, FE7-10-4C, FE-720, FE9-05, FE9-05-1C, FE9-05-2C...(Other models you can see in the webshop) |                 |                     |



Зип Общепит housing and bezels

vsezip.ru

+7(812)987-08-81



|                    |  |                 |                     |
|--------------------|--|-----------------|---------------------|
| <b>GEV No.</b>     | 691871   | <b>Ref. No.</b> | 12012807<br>T052603 |
| <b>description</b> | cover L 73mm H 33mm W 30mm   |                 |                     |
| <b>For models:</b> | BG7-05, BG7-05I, BG7-10, BG7-10I, BG9-05, BG9-05I, BG9-10, BG9-10I |                 |                     |

for griddles

spare parts and accessories



|                    |                              |                 |                     |
|--------------------|------------------------------|-----------------|---------------------|
| <b>GEV No.</b>     | 691703                       | <b>Ref. No.</b> | 12019787<br>U125409 |
| <b>description</b> | distance washer for handrail |                 |                     |
| <b>For models:</b> | CG-HP-20, FI-5420, FI-7630   |                 |                     |



|                    |   |                 |                     |
|--------------------|---|-----------------|---------------------|
| <b>GEV No.</b>     | 691683  | <b>Ref. No.</b> | 12007464<br>R152607 |
| <b>description</b> | holding plate for drain L 110mm W 60mm ID ø 48mm  |                 |                     |
| <b>For models:</b> | CG9-51L, CG9-51LC, CG9-51R, CG9-51RC, FTE7-05, FTE7-05L, FTE7-05R, FTE7-10, FTE7-10L, FTE7-10L+R, FTE7-10R, FTE9-05L, FTE9-05R, FTE9-10L, FTE9-10L+R, FTE9-10R, FTEC7-05L, FTEC7-10L, FTEC9-05L, FTEC9-05R, FTEC9-05USMC, FTEC9-10L, FTEC9-10L+R, FTEC9-10R, FTEC9-10USMC, FTG7-05, FTG7-05L, FTG7-05R, FTG7-05VL, FTG7-05VR, FTG7-10, FTG7-10L, FTG7-10L+R, FTG7-10R, FTG7-10VL, FTG7-10VL+R, FTG7-10VR, FTG9-05L, FTG9-05R, FTG9-05VL, FTG9-05VR, FTG9-10L, FTG9-10L+R, FTG9-10R, FTG9-10VL, FTG9-10VL+R, FTG9-10VR, FTG9-11L, FTG9-11L+R, FTG9-11R...(Other models you can see in the webshop) |                 |                     |

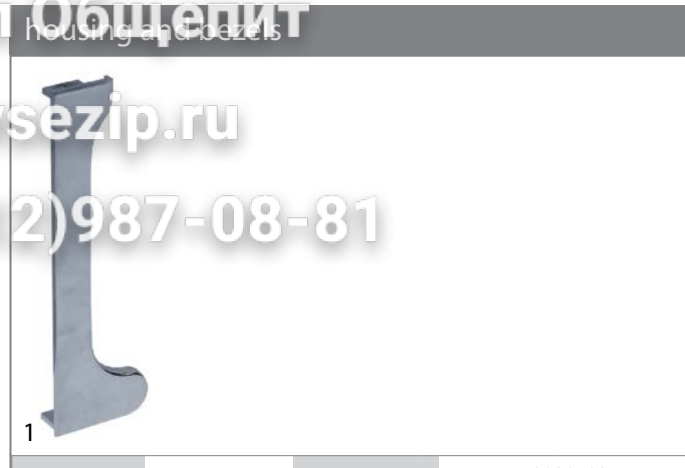

|                    |   |                 |                     |
|--------------------|---|-----------------|---------------------|
| <b>GEV No.</b>     | 210022  | <b>Ref. No.</b> | 12020193<br>U452805 |
| <b>description</b> | cover L 177mm W 52mm H 16mm for control panel mounting pos. left suitable for 700 series  |                 |                     |
| <b>For models:</b> | BG7-05, BG7-05I, BG7-10, BG7-10I, BME7-05, BME7-10, BMG7-10, CE7-20, CE7-40, CE7-41, CG7-10, CG7-11, CG7-20, CG-7200, CG7-40, CG-7400, CG7-41, CG-7415, CG7-61, CG-7615, CGB7-61, CGE7-41, CGE7-69, CPG7-05, EN7-05, EN7-10, FE-710, FE-720, FG-710, FG-720, FTE7-05, FTE7-05L, FTE7-05R, FTE7-10, FTE7-10L, FTE7-10L+R, FTE7-10R, FTEC7-05L, FTEC7-10L, FTG7-05, FTG7-05L, FTG7-05R, FTG7-05VL, FTG7-05VR, FTG7-10, FTG7-10L, FTG7-10L+R, FTG7-10R, FTG7-10VL, FTG7-10VL+R...(Other models you can see in the webshop) |                 |                     |

|                        |   |                 |                     |
|------------------------|---|-----------------|---------------------|
| <b>accessories for</b> | 210022  |                 |                     |
| <b>GEV No.</b>         | 210021  | <b>Ref. No.</b> | 12020194<br>U452804 |
| <b>description</b>     | cover L 177mm W 52mm H 16mm for control panel mounting pos. right suitable for 700 series |                 |                     |

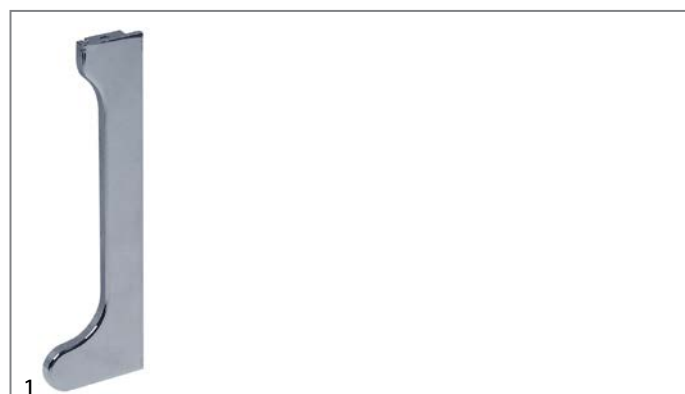

|                    |   |                 |                     |
|--------------------|---|-----------------|---------------------|
| <b>GEV No.</b>     | 210021  | <b>Ref. No.</b> | 12020194<br>U452804 |
| <b>description</b> | cover L 177mm W 52mm H 16mm for control panel mounting pos. right suitable for 700 series   |                 |                     |
| <b>For models:</b> | BG7-05, BG7-05I, BG7-10, BG7-10I, BME7-05, BME7-10, BMG7-10, CE7-20, CE7-40, CE7-41, CG7-10, CG7-11, CG7-20, CG-7200, CG7-40, CG-7400, CG7-41, CG-7415, CG7-61, CG-7615, CGB7-61, CGE7-41, CGE7-62, CPG7-05, EN7-05, EN7-10, FE-710, FE-720, FG-710, FG-720, FTE7-05, FTE7-05L, FTE7-05R, FTE7-10, FTE7-10L, FTE7-10L+R, FTE7-10R, FTEC7-05L, FTEC7-10L, FTG7-05, FTG7-05L, FTG7-05R, FTG7-05VL, FTG7-05VR, FTG7-10, FTG7-10L, FTG7-10L+R, FTG7-10R, FTG7-10VL, FTG7-10VL+R...(Other models you can see in the webshop) |                 |                     |

|                        |  |                 |                     |
|------------------------|--|-----------------|---------------------|
| <b>accessories for</b> | 210021   |                 |                     |
| <b>GEV No.</b>         | 210022   | <b>Ref. No.</b> | 12020193<br>U452805 |
| <b>description</b>     | cover L 177mm W 52mm H 16mm for control panel mounting pos. left suitable for 700 series |                 |                     |

Зип, Общепит

griddles

vsezip.ru

+7(812)987-08-81



1

|                    |  |                 |                     |
|--------------------|--|-----------------|---------------------|
| <b>GEV No.</b>     | 700809   | <b>Ref. No.</b> | 12007564<br>R205409 |
| <b>description</b> | fastening angle L 120mm W 67mm H 28mm  |                 |                     |
| <b>For models:</b> | BG9-05, BG9-10, BME9-05, BME9-10, BMG9-05, BMG9-10, CE9-20, CE9-40, CE9-41, CG9-10, CG9-11, CG9-20, CG9-40, CG9-41, CG9-60, CG9-61, CG9-82, EN9-05, EN9-10, FE-920, FG-920, FG-940, FTE9-05L, FTE9-05R, FTE9-10L, FTE9-10L+R, FTE9-10R, FTEC9-05, FTEC9-05L, FTEC9-05R, FTEC9-10, FTEC9-10L, FTEC9-10L+R, FTEC9-10R, FTG9-05L, FTG9-05R, FTG9-05VL, FTG9-05VR, FTG9-10L, FTG9-10L+R, FTG9-10R, FTG9-10VL, FTG9-10VL+R, FTG9-10VR, FTGC9-05, FTGC9-05L, FTGC9-05R, FTGC9-10, FTGC9-10L, FTGC9-10L+R...(Other models you can see in the webshop) |                 |                     |



1

|                    |  |                 |                     |
|--------------------|--|-----------------|---------------------|
| <b>GEV No.</b>     | 691721   | <b>Ref. No.</b> | 12012797<br>R162808 |
| <b>description</b> | front panel for griddle W 850mm H 150mm  |                 |                     |
| <b>For models:</b> | FTG9-10L, FTG9-10L+R, FTG9-10R, FTG9-10VL, FTG9-10VL+R, FTG9-10VR, FTGC9-10L, FTGC9-10L+R, FTGC9-10R |                 |                     |

Reglado a BUTANO-PROPANO  
Reglage BUTANE-PROPANE  
Regulated for L.P.G. using

1

|                    |  |                 |                     |
|--------------------|--|-----------------|---------------------|
| <b>GEV No.</b>     | 691735   | <b>Ref. No.</b> | 12008203<br>U136501 |
| <b>description</b> | sticker Regulated for L.P.G. using   |                 |                     |
| <b>For models:</b> | BG7-05, BG7-05I, BG7-10, BG7-10I, BG9-05, BG9-05I, BG9-05PF, BG9-05PI, BG9-10, BG9-10I, BG9-10PF, BG9-10PI, BME9-05, BME9-05V-T, BME9-10, BME9-10V-T, BMG7-10, BMG9-05, BMG9-05V-T, BMG9-10, BMG9-10V-T, CG-1002, CG-1502, CG-2000, CG-2005, CG-210, CG-210G, CG-3005, CG-310, CG-310G, CG7-10, CG7-11, CG-7115, CG7-20, CG-7200, CG7-20H, CG7-30D, CG7-30I, CG7-31D, CG7-31I, CG7-40, CG-7400, CG7-40H, CG7-41, CG-7415, CG7-41H, CG7-50, CG7-51, CG7-61, CG-7615...(Other models you can see in the webshop) |                 |                     |

Reglado a GAS NATURAL  
Reglage GAZ NATUREL  
Regulated for NATURAL GAS using

1

|                    |   |                 |                     |
|--------------------|---|-----------------|---------------------|
| <b>GEV No.</b>     | 691736  | <b>Ref. No.</b> | 12008202<br>U134402 |
| <b>description</b> | sticker regulated for NATURAL GAS using   |                 |                     |
| <b>For models:</b> | BG7-05, BG7-05I, BG7-10, BG7-10I, BG9-05, BG9-05I, BG9-05PF, BG9-05PI, BG9-10, BG9-10I, BG9-10PF, BG9-10PI, BME9-05, BME9-05V-T, BME9-10, BME9-10V-T, BMG7-10, BMG-9045, BMG9-05, BMG9-05V-T, BMG9-10, BMG9-10V-T, CG-1002, CG-1502, CG-2000, CG-2005, CG-210, CG-210G, CG-3005, CG-310, CG-310G, CG7-10, CG7-11, CG-7115, CG7-20, CG-7200, CG7-20H, CG7-30D, CG7-30I, CG7-31D, CG7-31I, CG7-40, CG-7400, CG7-40H, CG7-41, CG-7415, CG7-41H, CG7-50, CG7-51, CG7-61...(Other models you can see in the webshop) |                 |                     |

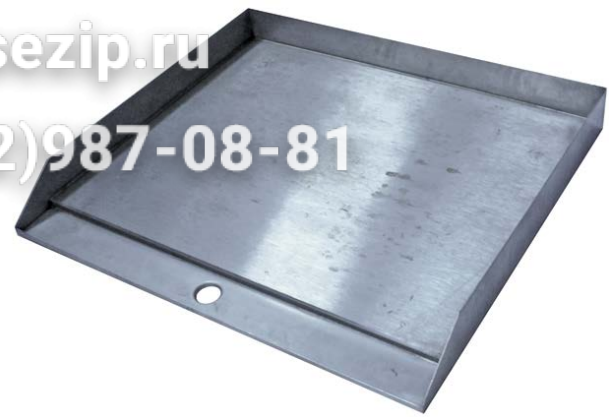

1

|                    |                                |                 |                     |
|--------------------|--------------------------------|-----------------|---------------------|
| <b>GEV No.</b>     | 691854                         | <b>Ref. No.</b> | 12015268<br>R795416 |
| <b>description</b> | griddle L 620mm W 695mm H 80mm |                 |                     |
| <b>For models:</b> | FTG7-10, FTG7-10L, FTG7-10VL   |                 |                     |



1

|                    |   |                 |                     |
|--------------------|---|-----------------|---------------------|
| <b>GEV No.</b>     | 691902  | <b>Ref. No.</b> | 12000919<br>R065407 |
| <b>description</b> | griddle L 875mm W 720mm H 80mm stainless steel            |                 |                     |
| <b>For models:</b> | FTG9-10PLUS-CLR, FTGC9-10L+R, FTGC9-10L+R-AD, FTGC9-11L+R |                 |                     |

## sumps



1

|                    |   |                 |                     |
|--------------------|---|-----------------|---------------------|
| <b>GEV No.</b>     | 691684  | <b>Ref. No.</b> | 12014843<br>R792606 |
| <b>description</b> | grease collecting tray L 265mm W 125mm H 50mm   |                 |                     |
| <b>For models:</b> | FTE7-05, FTE7-05L, FTE7-05R, FTE7-10, FTE7-10L, FTE7-10L+R, FTE7-10R, FTEC7-05L, FTEC7-10L, FTG7-05, FTG7-05L, FTG7-05R, FTG7-05VL, FTG7-05VR, FTG7-10, FTG7-10L, FTG7-10L+R, FTG7-10R, FTG7-10VL, FTG7-10VL+R, FTG7-10VR, FTGC7-05L, FTGC7-10L |                 |                     |



Зип Общепит

vsezip.ru

+7(812)987-08-81

drain stoppers



|   |  |                 |                     |                     |
|---|--|-----------------|---------------------|---------------------|
| 1   |  |                 |                     |                     |
| <b>GEV No.</b>  | 691686   | <b>Ref. No.</b> | 12019460<br>R619912 |                     |
| <b>description</b>  | plug bottom part D1 ø 40mm D2 ø 33.5mm H 30mm  |                 |                     |                     |
| <b>For models:</b>  | CG9-51LC, CG9-51RC, FTE7-05, FTE7-05L, FTE7-05R, FTE7-10, FTE7-10L, FTE7-10L+R, FTE7-10R, FTE9-05L, FTE9-05R, FTE9-10L, FTE9-10L+R, FTE9-10R, FTEC7-05L, FTEC7-10L, FTEC9-05, FTEC9-05L, FTEC9-05R, FTEC9-05USMC, FTEC9-10, FTEC9-10L, FTEC9-10L+R, FTEC9-10R, FTEC9-10USMC, FTG7-05, FTG7-05L, FTG7-05R, FTG7-10, FTG7-10L, FTG7-10L+R, FTG7-10R, FTG9-05L, FTG9-05R, FTG9-05VL, FTG9-05VR, FTG9-10L, FTG9-10L+R, FTG9-10R, FTG9-10VL, FTG9-10VL+R, FTG9-10VR, FTGC7-05L, FTGC7-10L, FTGC9-05, FTGC9-05L, FTGC9-05R, FTGC9-10, FTGC9-10L, FTGC9-10L+R...(Other models you can see in the webshop) |                 |                     |                     |
| <b>accessories for</b>  | 691686   |                 |                     |                     |
|  | <b>GEV No.</b>   | 111129          | <b>Ref. No.</b>     | 12008060<br>S116122 |
|   | cone handle thread M10 ø 34mm L 55mm plastic black   |                 |                     |                     |
|  | <b>GEV No.</b>   | 527396          | <b>Ref. No.</b>     | 12020466<br>R619913 |
|   | thread bolt for griddle L 50mm thread M10 stainless steel  |                 |                     |                     |



|                    |   |                 |          |  |
|--------------------|---|-----------------|----------|--|
| 1                  |   |                 |          |  |
| <b>GEV No.</b>     | 692329  | <b>Ref. No.</b> | 12023771 |  |
| <b>description</b> | drip rail L 700mm ABS plastic W 22mm hole ø 5mm for combi-steamer                     |                 |          |  |
| <b>For models:</b> | COE-061, COE-101, COG-061, COG-101, VE-061, VE-101, VG-101, VPE-061, VPE-101, VPG-101 |                 |          |  |

for chicken rotisserie

miscellaneous



|                    |   |                 |                     |  |
|--------------------|---|-----------------|---------------------|--|
| 1                  |   |                 |                     |  |
| <b>GEV No.</b>     | 691877  | <b>Ref. No.</b> | 12039840<br>Z200513 |  |
| <b>description</b> | bolt ø 8mm L 31.5mm head ø 12mm head thickness 2.5mm SS |                 |                     |  |

for convection ovens/combi-steamers

drain units

drip rails



|                    |  |                 |                        |  |
|--------------------|--|-----------------|------------------------|--|
| 1                  |  |                 |                        |  |
| <b>GEV No.</b>     | 696855   | <b>Ref. No.</b> | 12039485<br>T800563000 |  |
| <b>description</b> | drip rail L 540mm plastic W 44.5mm   |                 |                        |  |
| <b>For models:</b> | ACE-061, ACE-101, ACG-061, ACG-101, AE-061, AE-061W, AE-101, AE-101W, AG-061, AG-061W, AG-101, AG-101W, APE-061, APE-061W, APE-101, APE-101W, APG-061, APG-061W, APG-101, APG-101W |                 |                        |  |

drain valves



|                    |                                    |                 |          |  |
|--------------------|------------------------------------|-----------------|----------|--|
| 1                  |                                    |                 |          |  |
| <b>GEV No.</b>     | 696854                             | <b>Ref. No.</b> | 12126816 |  |
| <b>description</b> | drain fitting for combi-steamer    |                 |          |  |
| <b>For models:</b> | APE-201, APE-202, APG-201, APG-202 |                 |          |  |



|                    |   |                 |          |  |
|--------------------|---|-----------------|----------|--|
| 1                  |   |                 |          |  |
| <b>GEV No.</b>     | 696858  | <b>Ref. No.</b> | 12043409 |  |
| <b>description</b> | bush ID ø 4mm ED ø 8mm L 5.5mm  |                 |          |  |
| <b>For models:</b> | ACE-061, ACE-101, ACE-102, ACE-201, ACE-202, ACG-061, ACG-101, ACG-201, ACG-202, AE-061, AE-061W, AE-101, AE-101W, AE-102, AE-102W, AE-201, AE-202, AG-061, AG-061W, AG-101, AG-101W, AG-201, AG-202, APE-061, APE-061W, APE-101, APE-101W, APE-102, APE-102W, APE-201, APE-202, APG-061, APG-061W, APG-101, APG-101W, APG-201, APG-202 |                 |          |  |



|                    |  |                 |                                   |  |
|--------------------|--|-----------------|-----------------------------------|--|
| 1                  |  |                 |                                   |  |
| <b>GEV No.</b>     | 696856   | <b>Ref. No.</b> | 12023506<br>Z608410<br>Z608410000 |  |
| <b>description</b> | bush ID ø 7mm ED ø 11mm L 8mm  |                 |                                   |  |
| <b>For models:</b> | ACE-201, ACE-202, ACG-201, ACG-202, AE-201, AE-202, AG-201, AG-202, APE-201, APE-202, APG-201, APG-202 |                 |                                   |  |

## steam generators

## steam generators



1

|                    |   |                 |          |
|--------------------|---|-----------------|----------|
| <b>GEV No.</b>     | 692897                                  | <b>Ref. No.</b> | 12046049 |
| <b>description</b> | steam generator L 290mm W 120mm H 300mm |                 |          |
| <b>For models:</b> | AE-101, AE-101W, APE-101, APE-101W      |                 |          |



1

|                    |   |                 |          |
|--------------------|---|-----------------|----------|
| <b>GEV No.</b>     | 692906                                      | <b>Ref. No.</b> | 12046048 |
| <b>description</b> | steam generator L 300mm W 120mm H 420mm     |                 |          |
| <b>For models:</b> | ACE-061, AE-061, AE-061W, APE-061, APE-061W |                 |          |



1

|                    |  |                 |          |
|--------------------|--|-----------------|----------|
| <b>GEV No.</b>     | 696836   | <b>Ref. No.</b> | 12046053 |
| <b>description</b> | steam generator L 310mm W 120mm H 530mm                      |                 |          |
| <b>For models:</b> | ACE-102, AE-102, AE-102W, AE-201, APE-102, APE-102W, APE-201 |                 |          |

Зип Общепит

vsezip.ru

+7(812)987-08-81



1

|                    |   |                 |   |
|--------------------|---|-----------------|---|
| <b>GEV No.</b>     | 691849  | <b>Ref. No.</b> | 1100002823<br>12000181<br>12010918<br>R145001 |
| <b>description</b> | steam generator L 425mm W 110mm H 530mm   |                 |   |
| <b>For models:</b> | HME-20-21, HME-2-20-11, HMM-20-21, HMM-20-21UL, HMM-2-20-11, HMM-40-11-USMC, HMP-20-21, HMP-2-20-11 |                 |   |



1

|                    |                                       |                 |                        |
|--------------------|---------------------------------------|-----------------|------------------------|
| <b>GEV No.</b>     | 697779                                | <b>Ref. No.</b> | 12025526<br>RT83507100 |
| <b>description</b> | steam generator suitable for RATIONAL |                 |                        |

## steam pipes



1

|                    |  |                 |                       |
|--------------------|--|-----------------|-----------------------|
| <b>GEV No.</b>     | 530875   | <b>Ref. No.</b> | 12031550<br>RT4400362 |
| <b>description</b> | steam hose ext. $\varnothing$ 78 ID $\varnothing$ 70mm L 54mm silicone red/black |                 |                       |

Зип Общепит

vsezip.ru

+7(812)987-08-81



1

|                    |  |                 |          |
|--------------------|--|-----------------|----------|
| <b>GEV No.</b>     | 521283   | <b>Ref. No.</b> | 12047930 |
| <b>description</b> | steam pipe L 200mm W 85mm ø 53mm for combi-steamer steam generator   |                 |          |
| <b>For models:</b> | ACE-061, ACE-102, AE-061, AE-061W, AE-101, AE-101W, AE-102, AE-102W, AE-201, AE-202, APE-061, APE-061W, APE-101, APE-101W, APE-102, APE-102W, APE-201, APE-202 |                 |          |



1

|                    |                      |                 |                     |
|--------------------|----------------------|-----------------|---------------------|
| <b>GEV No.</b>     | 692042               | <b>Ref. No.</b> | 12012959<br>R722702 |
| <b>description</b> | injection pipe steam |                 |                     |



1

|                    |  |                 |                     |
|--------------------|--|-----------------|---------------------|
| <b>GEV No.</b>     | 691729   | <b>Ref. No.</b> | 12015182<br>R675019 |
| <b>description</b> | steam pipe T-piece SS L 190mm ID ø 50mm ED ø 53mm  |                 |                     |
| <b>For models:</b> | HEM-10-11, HEM-6-11, HEP-10-11, HEP-6-11, HME-10-11, HME-10-21, HME-20-21, HME-2-10-11, HME-2-20-11, HME-6-11, HMM-10-11, HMM-10-21, HMM-20-21, HMM-20-21UL, HMM-2-10-11, HMM-2-20-11, HMM-40-11-USMC, HMM-6-11, HMP-10-11, HMP-10-21, HMP-20-21, HMP-2-10-11, HMP-2-20-11, HMP-6-11 |                 |                     |

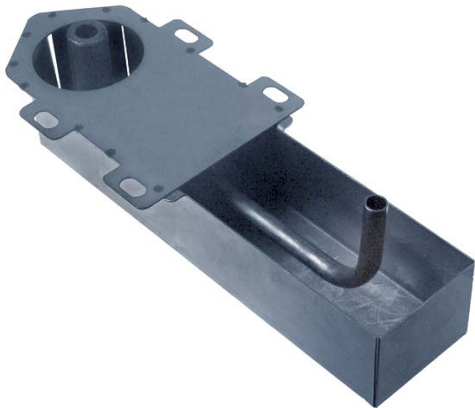

1

|                    |                      |                 |                     |
|--------------------|----------------------|-----------------|---------------------|
| <b>GEV No.</b>     | 692043               | <b>Ref. No.</b> | 12013564<br>T072605 |
| <b>description</b> | injection pipe steam |                 |                     |
| <b>For models:</b> | HMG-6-11             |                 |                     |

injection pipes



1

|                    |   |                 |                    |
|--------------------|---|-----------------|--------------------|
| <b>GEV No.</b>     | 694069                                      | <b>Ref. No.</b> | 12013716<br>T07500 |
| <b>description</b> | injection pipe L1 180mm L2 65mm tube ø 10mm |                 |                    |



1

|                    |   |                 |                     |
|--------------------|---|-----------------|---------------------|
| <b>GEV No.</b>     | 691901  | <b>Ref. No.</b> | 12014384<br>R665020 |
| <b>description</b> | injector pipe L1 175mm L2 65mm tube ø 10mm mounting distance 36mm |                 |                     |
| <b>For models:</b> | HME-6-11, HMI-6-11, HMI-6-11UL, HMP-6-11                          |                 |                     |



1

|                    |   |                 |                     |
|--------------------|---|-----------------|---------------------|
| <b>GEV No.</b>     | 694070  | <b>Ref. No.</b> | 12014333<br>R675017 |
| <b>description</b> | injection pipe L1 225mm L2 65mm tube ø 10mm mounting distance 36mm  |                 |                     |
| <b>For models:</b> | HME-10-11, HME-10-21, HME-20-11, HME-20-21, HME-2-10-11, HME-2-20-11, HMI-10-11, HMI-10-11UL, HMI-10-21, HMI-10-21UL, HMI-2-10-11, HMP-10-11, HMP-10-21, HMP-20-11, HMP-20-21, HMP-2-10-11, HMP-2-20-11 |                 |                     |

spare parts and accessories



1

|                    |  |                 |                        |
|--------------------|--|-----------------|------------------------|
| <b>GEV No.</b>     | 551460   | <b>Ref. No.</b> | 12023647<br>T723007000 |
| <b>description</b> | cover cap for USB-conection with internal thread ø 38mm  |                 |                        |
| <b>For models:</b> | ACE-061, ACE-101, AE-061, AE-101, APE-061, APE-061W, APE-101, APE-101W, APE-102, APE-102W, APE-201, APE-202, APG-061, APG-061W, APG-101, APG-101W, APG-102, APG-102W, APG-201, APG-202 |                 |                        |

Зип.Общепит

glass panels

vsezip.ru

+7(812)987-08-81

|                    |  |                 |          |
|--------------------|--|-----------------|----------|
| 1                  |   |                 |          |
| <b>GEV No.</b>     | 403747   | <b>Ref. No.</b> | 12043405 |
| <b>description</b> | potentiometer rotation 360° shaft ø 6x4.6mm shaft L 13mm   |                 |          |
| <b>For models:</b> | ACE-061, ACE-101, AE-061, AE-061W, AE-101, AE-101W, AE-102, AE-102W, AE-201, AE-202, AG-061, AG-061W, AG-101, AG-101W, AG-102, AG-102W, AG-201, AG-202, APE-061, APE-101 |                 |          |

## filters

|                    |   |                 |                        |
|--------------------|---|-----------------|------------------------|
| 1                  |  |                 |                        |
| <b>GEV No.</b>     | 701580  | <b>Ref. No.</b> | 12032599<br>RT20050307 |
| <b>description</b> | drain filter ø 71mm H 18mm IT M6 for combi-steamer model CPC-Linie CPC 61/101/201 |                 |                        |

## housing and bezels

|                    |   |                 |                     |
|--------------------|---|-----------------|---------------------|
| 1                  | <br>Image not available  |                 |                     |
| <b>GEV No.</b>     | 691882  | <b>Ref. No.</b> | 12011627<br>R675005 |
| <b>description</b> | fastening angle L 35mm W 35mm H 42mm  |                 |                     |
| <b>For models:</b> | HEI-10-11, HEI-20-11, HEI-6-11, HEM-10-11, HEM-20-11, HEM-6-11, HEP-10-11, HEP-20-11, HEP-6-11, HME-10-11, HME-10-21, HME-20-11, HME-20-21, HME-2-10-11, HME-2-20-11, HME-6-11, HMI-10-11, HMI-10-11UL, HMI-10-21, HMI-10-21UL, HMI-2-10-11, HMI-6-11, HMI-6-11UL, HMM-10-11, HMM-10-11UL, HMM-10-21, HMM-10-21UL, HMM-20-11, HMM-20-11UL, HMM-20-21, HMM-20-21UL, HMM-2-10-11, HMM-2-20-11, HMM-40-11-USMC, HMM-6-11, HMM-6-11UL, HMP-10-11, HMP-10-21, HMP-20-11, HMP-20-21, HMP-2-10-11, HMP-2-20-11, HMP-6-11 |                 |                     |

|                    |   |                 |  |
|--------------------|---|-----------------|--|
| 1                  |    |                 |  |
| <b>GEV No.</b>     | 691691  | <b>Ref. No.</b> | 12009010<br>12009015<br>U022836<br>U262806 |
| <b>description</b> | type plate FAGOR metal  |                 |  |
| <b>For models:</b> | BG6-05I, BG7-05, BG7-05I, BG7-10, BG7-10I, BG9-05, BG9-05AD, BG9-05I, BG9-05PF, BG9-05PI, BG9-05PLUS-I, BG9-10, BG9-10AD, BG9-10I, BG9-10PF, BG9-10PI, BG9-10PLUS-I, BME6-05, BME7-05, BME7-10, BME9-05, BME9-05AD, BME9-05PLUS, BME9-05V-T, BME9-10, BME9-10AD, BME9-10PLUS, BME9-10V-T, BMG7-10, BMG9-05, BMG9-05V-T, BMG9-10, BMG9-10V-T, CE6-20, CE6-40, CE6-41, CE7-20, CE7-40, CE7-41, CE9-20, CE9-20AD, CE9-20PLUS, CE9-40, CE9-40AD, CE9-40PLUS, CE9-41, CE9-41AD, CE9-41PLUS, CG-1002, CG-1502...(Other models you can see in the webshop) |                 |  |

|                    |   |                 |                       |
|--------------------|---|-----------------|-----------------------|
| 1                  |         |                 |                       |
| <b>GEV No.</b>     | 692856  | <b>Ref. No.</b> | 12025892<br>RT2400212 |
| <b>description</b> | door glass for combi-steamer SCC/CM202 L 1340mm mounting pos. inner W 680mm thickness 6mm |                 |                       |

|                    |  |                 |           |
|--------------------|--|-----------------|-----------|
| 1                  |  |                 |           |
| <b>GEV No.</b>     | 694938   | <b>Ref. No.</b> | RT2400200 |
| <b>description</b> | glass panel for door inside combi-steamer SCC/CM102 L 763mm W 680mm thickness 7mm  |                 |           |

|                    |   |                 |                       |
|--------------------|---|-----------------|-----------------------|
| 1                  |  |                 |                       |
| <b>GEV No.</b>     | 694492  | <b>Ref. No.</b> | 12027606<br>RT2400163 |
| <b>description</b> | glass panel L 485mm W 508mm thickness 6mm mounting pos. inner for combi-steamer     |                 |                       |

|                    |   |                 |                     |
|--------------------|---|-----------------|---------------------|
| 1                  |   |                 |                     |
| <b>GEV No.</b>     | 700832  | <b>Ref. No.</b> | 12017461<br>R680508 |
| <b>description</b> | glass panel L 820mm W 765mm thickness 5mm rectangular mounting pos. inner   |                 |                     |
| <b>For models:</b> | HCG-10-21, HCG-2-10-11, HME-10-21, HME-2-10-11, HMG-10-21, HMG-10-21UL, HMG-2-10-11, HMI-10-21, HMI-10-21UL, HMI-2-10-11, HMM-10-21, HMM-10-21UL, HMM-2-10-11, HMP-10-21, HMP-2-10-11 |                 |                     |

## air filters

|                    |  |                 |                       |
|--------------------|--|-----------------|-----------------------|
| 1                  |  |                 |                       |
| <b>GEV No.</b>     | 692694   | <b>Ref. No.</b> | 12033202<br>RT1600673 |
| <b>description</b> | filter L 220mm W 50mm ømm H 150mm SCC Line   |                 |                       |





Зип Общепит

vsezip.ru

+7(812)987-08-81



|                    |   |                 |                        |
|--------------------|---|-----------------|------------------------|
| <b>GEV No.</b>     | 692695                                  | <b>Ref. No.</b> | 12034505<br>RT84551377 |
| <b>description</b> | filter insert L 213mm W 60mm ømm H 90mm |                 |                        |

cleaning system

nozzles



|                    |  |                 |                     |
|--------------------|--|-----------------|---------------------|
| <b>GEV No.</b>     | 505230   | <b>Ref. No.</b> | 12017281<br>Z651931 |
| <b>description</b> | rinse jet H 12mm thread M10x1 WS 14 hole ø 1.6mm |                 |                     |

**For models:** FI-300B, FI-300R, FI-650R, HCV-10-11, HCV-10-21, HCV-2-10-21, HCV-6-11, HEM-10-11, HEM-20-11, HEM-6-11, HEP-10-11, HEP-20-11, HEP-6-11, HME-10-11, HME-10-21, HME-20-11, HME-20-21, HME-2-10-11, HME-2-20-11, HME-6-11, HMM-10-11, HMM-10-11UL, HMM-10-21, HMM-10-21UL, HMM-20-11, HMM-20-11UL, HMM-20-21, HMM-20-21UL, HMM-2-10-11, HMM-2-20-11, HMM-40-11-USMC, HMM-6-11, HMM-6-11UL, HMP-10-11, HMP-10-21, HMP-20-11, HMP-20-21, HMP-2-10-11, HMP-2-20-11, HMP-6-11



|                    |                                   |                 |                     |
|--------------------|-----------------------------------|-----------------|---------------------|
| <b>GEV No.</b>     | 505232                            | <b>Ref. No.</b> | 12021186<br>Z651932 |
| <b>description</b> | swirl H 10.7mm ø 6mm 1.5mm H1 5mm |                 |                     |

**For models:** FI-300B, FI-300R, FI-650R, HCV-10-11, HCV-10-21, HCV-2-10-21, HCV-6-11, HEM-10-11, HEM-20-11, HEM-6-11, HEP-10-11, HEP-20-11, HEP-6-11, HME-10-11, HME-10-21, HME-20-11, HME-20-21, HME-2-10-11, HME-2-20-11, HME-6-11, HMM-10-11, HMM-10-11UL, HMM-10-21, HMM-10-21UL, HMM-20-11, HMM-20-11UL, HMM-20-21, HMM-20-21UL, HMM-2-10-11, HMM-2-20-11, HMM-40-11-USMC, HMM-6-11, HMM-6-11UL, HMP-10-11, HMP-10-21, HMP-20-11, HMP-20-21, HMP-2-10-11, HMP-2-20-11, HMP-6-11

coupling bushings



|                    |                                   |                 |                        |
|--------------------|-----------------------------------|-----------------|------------------------|
| <b>GEV No.</b>     | 694486                            | <b>Ref. No.</b> | 12031521<br>RT20620348 |
| <b>description</b> | coupling bush for cleaning system |                 |                        |



|                    |                                   |                 |                        |
|--------------------|-----------------------------------|-----------------|------------------------|
| <b>GEV No.</b>     | 694487                            | <b>Ref. No.</b> | 12031179<br>RT20620347 |
| <b>description</b> | coupling bush for cleaning system |                 |                        |



|                    |                                   |                 |                        |
|--------------------|-----------------------------------|-----------------|------------------------|
| <b>GEV No.</b>     | 694488                            | <b>Ref. No.</b> | 12030870<br>RT20620350 |
| <b>description</b> | coupling bush for cleaning system |                 |                        |



|                    |                                   |                 |                        |
|--------------------|-----------------------------------|-----------------|------------------------|
| <b>GEV No.</b>     | 694489                            | <b>Ref. No.</b> | 12029908<br>RT20620349 |
| <b>description</b> | coupling bush for cleaning system |                 |                        |

pumps

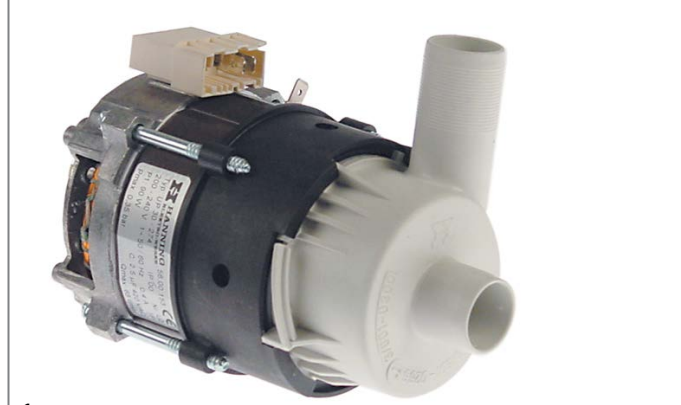

|                    |  |                 |                        |
|--------------------|--|-----------------|------------------------|
| <b>GEV No.</b>     | 500578   | <b>Ref. No.</b> | 12026928<br>RT5600153P |
| <b>description</b> | pump inlet ø 24mm outlet ø 24mm type UP30-274 230V 50/60Hz 1 phase 0.09kW 0.12HP L 145mm rotation direction left capacitor 2.5µF HANNING |                 |                        |

**spare parts for** 500578

|                |   |                 |   |
|----------------|---|-----------------|---|
| <b>GEV No.</b> | 501345  | <b>Ref. No.</b> | — |
|                | O-ring EPDM thickness 3mm ID ø 58mm Qty 1 pcs |                 |   |



|                    |  |                 |                        |
|--------------------|--|-----------------|------------------------|
| <b>GEV No.</b>     | 500579   | <b>Ref. No.</b> | 12026728<br>RT5600178P |
| <b>description</b> | pump inlet ø 24mm outlet ø 24mm type UP30-275 230V 50/60Hz 1 phase 0.09kW 0.12HP L 145mm rotation direction left capacitor 2.5µF HANNING |                 |                        |

**spare parts for** 500579

|                |   |                 |   |
|----------------|---|-----------------|---|
| <b>GEV No.</b> | 501345  | <b>Ref. No.</b> | — |
|                | O-ring EPDM thickness 3mm ID ø 58mm Qty 1 pcs |                 |   |

## cleaning arms



1

|                |        |                 |                        |
|----------------|--------|-----------------|------------------------|
| <b>GEV No.</b> | 541433 | <b>Ref. No.</b> | 12026700<br>RT86552101 |
|----------------|--------|-----------------|------------------------|

**description** cleaning arm CleanJet suitable for RATIONAL \_101-\_202

## non-return valves



1

|                |        |                 |                        |
|----------------|--------|-----------------|------------------------|
| <b>GEV No.</b> | 531321 | <b>Ref. No.</b> | 12035266<br>RT20690107 |
|----------------|--------|-----------------|------------------------|

**description** non-return valve



1

|                |        |                 |                       |
|----------------|--------|-----------------|-----------------------|
| <b>GEV No.</b> | 531297 | <b>Ref. No.</b> | 12033754<br>RT5000078 |
|----------------|--------|-----------------|-----------------------|

**description** non-return valve  $\varnothing$  16.4mm L 18mm

## hoses



1

|                |        |                 |                        |
|----------------|--------|-----------------|------------------------|
| <b>GEV No.</b> | 530794 | <b>Ref. No.</b> | 12031663<br>RT21121304 |
|----------------|--------|-----------------|------------------------|

**description** formed hose ED  $\varnothing$  29mm ID  $\varnothing$  23mm L 485mm for combi-steamer CPC-Linie 102/201E



1

|                |        |                 |                       |
|----------------|--------|-----------------|-----------------------|
| <b>GEV No.</b> | 530791 | <b>Ref. No.</b> | 12031730<br>RT4400242 |
|----------------|--------|-----------------|-----------------------|

**description** formed hose ED  $\varnothing$  29mm ID  $\varnothing$  23mm L 730mm for combi-steamer SCC Linie 202

Зип Общепит

vsezip.ru

+7(812)987-08-81



1

|                |        |                 |                        |
|----------------|--------|-----------------|------------------------|
| <b>GEV No.</b> | 530792 | <b>Ref. No.</b> | 12031089<br>RT21121305 |
|----------------|--------|-----------------|------------------------|

**description** formed hose ID  $\varnothing$  22mm ED  $\varnothing$  29mm L 640mm for combi-steamer CPC 202



1

|                |        |                 |                        |
|----------------|--------|-----------------|------------------------|
| <b>GEV No.</b> | 694490 | <b>Ref. No.</b> | 12036856<br>RT21121310 |
|----------------|--------|-----------------|------------------------|

**description** formed hose ID  $\varnothing$  22mm ED  $\varnothing$  30mm L 80mm steam generator



1

|                |        |                 |                        |
|----------------|--------|-----------------|------------------------|
| <b>GEV No.</b> | 696852 | <b>Ref. No.</b> | 12024425<br>T330731000 |
|----------------|--------|-----------------|------------------------|

**description** hose ID  $\varnothing$  30/23mm ED  $\varnothing$  36/30mm L 177mm for combi-steamer

**For models:** APE-102, APE-102W, APE-202, APG-102, APG-202



1

|                |        |                 |                        |
|----------------|--------|-----------------|------------------------|
| <b>GEV No.</b> | 530918 | <b>Ref. No.</b> | 12039649<br>T945056000 |
|----------------|--------|-----------------|------------------------|

**description** hose ID  $\varnothing$  30mm ED  $\varnothing$  40mm L 110mm for steam generator

**For models:** ACE-102, AE-102, AE-102W, AE-201, AE-202, AG-061, AG-061W, AG-101, AG-101W, AG-102, AG-102W, AG-201, AG-202, APE-102, APE-102W, APE-201, APE-202, APG-061, APG-061W, APG-101, APG-101W, APG-102, APG-102W, APG-201, APG-202

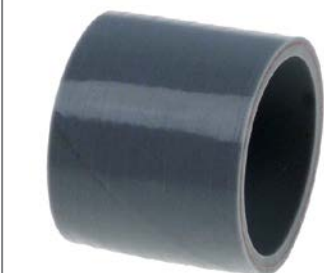

1

|                |        |                 |                        |
|----------------|--------|-----------------|------------------------|
| <b>GEV No.</b> | 692102 | <b>Ref. No.</b> | 12031714<br>RT21121006 |
|----------------|--------|-----------------|------------------------|

**description** hose ID  $\varnothing$  50mm ED  $\varnothing$  60mm L 50mm



Зип Общежит

SERVICE

vsezip.ru

+7(812)987-08-81



1

|                    |   |                 |                        |
|--------------------|---|-----------------|------------------------|
| <b>GEV No.</b>     | 694321  | <b>Ref. No.</b> | 12037987<br>RT21121307 |
| <b>description</b> | hose ID $\phi$ 70mm ext. $\phi$ 80 L 80mm for combi-steamer |                 |                        |



1

|                    |  |                 |          |
|--------------------|--|-----------------|----------|
| <b>GEV No.</b>     | 530919   | <b>Ref. No.</b> | 12044832 |
| <b>description</b> | hose ID $\phi$ 73mm ED $\phi$ 85mm L 150mm for steam generator |                 |          |
| <b>For models:</b> | AG-202, APG-202  |                 |          |



1

|                    |   |                 |                        |
|--------------------|---|-----------------|------------------------|
| <b>GEV No.</b>     | 530795  | <b>Ref. No.</b> | 12035289<br>RT21101029 |
| <b>description</b> | silicone hose ID $\phi$ 6mm ED $\phi$ 10mm L 1085mm for combi-steamer CPC-Linie CM 61-202/G white |                 |                        |



1

|                    |   |                 |                        |
|--------------------|---|-----------------|------------------------|
| <b>GEV No.</b>     | 530798  | <b>Ref. No.</b> | 12034250<br>RT21101030 |
| <b>description</b> | silicone hose ID $\phi$ 6mm ED $\phi$ 10mm L 1120mm for combi-steamer CPC-Linie CM 61-202/G |                 |                        |



1

|                    |  |                 |                       |
|--------------------|--|-----------------|-----------------------|
| <b>GEV No.</b>     | 530875   | <b>Ref. No.</b> | 12031550<br>RT4400362 |
| <b>description</b> | steam hose ext. $\phi$ 78 ID $\phi$ 70mm L 54mm silicone red/black |                 |                       |



|                        |   |                 |                        |   |
|------------------------|---|-----------------|------------------------|---|
| <b>GEV No.</b>         | 530874  | <b>Ref. No.</b> | 12026779<br>RT87201521 |   |
| <b>description</b>     | conversion kit - for combi-steamer CPC-Linie 61-102E RATIONAL |                 |                        |   |
| <b>spare parts for</b> | 530874  |                 |                        |   |
|                        | <b>GEV No.</b>  | 692215          | <b>Ref. No.</b>        | — |
|                        | conversion kit for tank inlet fitting                         |                 |                        |   |

drip water trays



1

|                    |   |                 |                       |
|--------------------|---|-----------------|-----------------------|
| <b>GEV No.</b>     | 699800                                  | <b>Ref. No.</b> | 12033203<br>RT5000300 |
| <b>description</b> | drip tray plastic L 745mm W 47mm H 20mm |                 |                       |

door mechanics

holders



1

|                    |  |                 |                     |
|--------------------|--|-----------------|---------------------|
| <b>GEV No.</b>     | 691904   | <b>Ref. No.</b> | 12002903<br>U065658 |
| <b>description</b> | bracket for gasket angled L 405mm W 20mm H 20mm mounting distance 98mm stainless steel |                 |                     |

miscellaneous



1

|                    |   |                 |                        |
|--------------------|---|-----------------|------------------------|
| <b>GEV No.</b>     | 694934  | <b>Ref. No.</b> | 12031180<br>RT29401306 |
| <b>description</b> | cover for door latch suitable for combi-steamer CPC-Linie 201/202 aluminium L 96.5mm W 65.5mm |                 |                        |

## accessories



1

|                    |  |                 |                                   |
|--------------------|--|-----------------|-----------------------------------|
| <b>GEV No.</b>     | 696851   | <b>Ref. No.</b> | 12022138<br>R660538<br>R660538000 |
| <b>description</b> | base plate W 40mm zinc-plated sheet steel L 44mm   |                 |                                   |
| <b>For models:</b> | ACE-201, ACE-202, ACG-201, ACG-202, AE-201, AE-202, AG-201, AG-202, APE-201, APE-202, APG-201, APG-202 |                 |                                   |



1

|                    |                                    |                 |                        |
|--------------------|------------------------------------|-----------------|------------------------|
| <b>GEV No.</b>     | 694656                             | <b>Ref. No.</b> | 12037230<br>RT20390402 |
| <b>description</b> | door bumper silicone ø 13mm L 19mm |                 |                        |

## vibration pumps



1

|                    |   |                 |                        |
|--------------------|---|-----------------|------------------------|
| <b>GEV No.</b>     | 500580  | <b>Ref. No.</b> | 12028569<br>RT87201526 |
| <b>description</b> | vibration pump 230V 60W 50/60Hz inlet ø 7 outlet ø 1/8" IT CEME type E512 with accessories duty cycle 1/2 ambient temperature max. 60°C medium temp max. 35°C overheating protection 110°C CleanJet |                 |                        |

## heat exchangers



1

|                    |  |                 |                     |
|--------------------|--|-----------------|---------------------|
| <b>GEV No.</b>     | 109075   | <b>Ref. No.</b> | 12022680<br>R725709 |
| <b>description</b> | flange ED ø 85mm thickness 2mm   |                 |                     |
| <b>For models:</b> | HCG-10-11, HCG-10-21, HCG-20-11, HCG-2-10-11, HMG-10-11, HMG-10-11UL, HMG-10-21, HMG-10-21UL, HMG-20-11, HMG-2-10-11 |                 |                     |



1

|                    |   |                 |                     |
|--------------------|---|-----------------|---------------------|
| <b>GEV No.</b>     | 109072                                    | <b>Ref. No.</b> | 12011760<br>T075700 |
| <b>description</b> | heat exchanger ED ø 405mm H 500mm W 140mm |                 |                     |
| <b>For models:</b> | HMG-6-11                                  |                 |                     |



1

|                    |                                 |                 |                     |
|--------------------|---------------------------------|-----------------|---------------------|
| <b>GEV No.</b>     | 109076                          | <b>Ref. No.</b> | 12011269<br>T135700 |
| <b>description</b> | heat exchanger H 1200mm W 570mm |                 |                     |



1

|                    |  |                 |                     |
|--------------------|--|-----------------|---------------------|
| <b>GEV No.</b>     | 520404   | <b>Ref. No.</b> | 12023740<br>T115084 |
| <b>description</b> | reducing washer gas burner brass ID ø 16mm ED ø 58mm thickness 3mm type 16 |                 |                     |



1

|                    |  |                 |                     |
|--------------------|--|-----------------|---------------------|
| <b>GEV No.</b>     | 520403   | <b>Ref. No.</b> | 12018367<br>T115082 |
| <b>description</b> | reducing washer gas burner brass ID ø 18mm ED ø 58mm thickness 3mm type 18   |                 |                     |
| <b>For models:</b> | HCG-10-11, HCG-10-21, HCG-2-10-11, HGC-10-11, HGV-10-11, HVG-10-11, HVG-10-11UL, HVG-10-21, HVG-10-21UL, HVG-2-10-11, MFHVG-10-11, MFHVG-10-21 |                 |                     |



1

|                    |  |                 |                     |
|--------------------|--|-----------------|---------------------|
| <b>GEV No.</b>     | 109073   | <b>Ref. No.</b> | 12018368<br>T115083 |
| <b>description</b> | reducing washer ID ø 20mm ED ø 58mm W 3mm code 20  |                 |                     |
| <b>For models:</b> | HCG-10-11, HCG-10-21, HCG-2-10-11, HGC-10-11, HGV-10-11, HVG-10-11, HVG-10-11UL, HVG-10-21, HVG-10-21UL, HVG-2-10-11, MFHVG-10-11, MFHVG-10-21 |                 |                     |

## miscellaneous



1

|   |  |                 |                        |
|---|--|-----------------|------------------------|
| <b>GEV No.</b>  | 694433   | <b>Ref. No.</b> | 12036082<br>RT20690108 |
| <b>description</b>  | air valve for combi-steamer bore ø 2mm L 18mm plastic ø 20mm |                 |                        |
| <b>accessories for</b>  | 694433   |                 |                        |
|  | <b>GEV No.</b>   | <b>Ref. No.</b> | 12033922<br>RT83541304 |
| valve body for air valve hose ø 10mm  |  |                 |                        |

Зип Общепит  
vsezip.ru  
(812)987-08-81



Зип Общепит

vsezip.ru

+7(812)987-08-81

|  |  |                 |         |
|--|--|-----------------|---------|
|  <p>1</p> |  |                 |         |
| <b>GEV No.</b>   | 692330   | <b>Ref. No.</b> | 1202242 |
| <b>description</b>   | atomizer for combi-steamer L 97mm ø 43mm hole ø 10mm                     |                 |         |
| <b>For models:</b>   | ACE-201, ACE-202, COE-061, COE-101, COE-102, COE-201, COE-202, HEI-20-11 |                 |         |

|  |                             |                 |                        |
|--|-----------------------------|-----------------|------------------------|
|  <p>1</p> |                             |                 |                        |
| <b>GEV No.</b>   | 693533                      | <b>Ref. No.</b> | 12035275<br>RT29201300 |
| <b>description</b>   | bracket for level electrode |                 |                        |

|   |  |                 |                     |
|---|--|-----------------|---------------------|
|  <p>1</p> |  |                 |                     |
| <b>GEV No.</b>  | 691689   | <b>Ref. No.</b> | 12014956<br>R660539 |
| <b>description</b>  | bracket for lighting   |                 |                     |
| <b>For models:</b>  | HCG-10-11, HCG-10-21, HCG-20-11, HCG-2-10-11, HCG-6-11, HME-10-11, HME-10-21, HME-20-11, HME-20-21, HME-2-10-11, HME-6-11, HMG-10-11, HMG-10-11UL, HMG-10-21, HMG-10-21UL, HMG-20-11, HMG-2-10-11, HMG-6-11, HMI-10-11, HMI-10-11UL, HMI-10-21, HMI-10-21UL, HMI-2-10-11, HMI-6-11, HMI-6-11UL, HMM-10-11, HMM-10-11UL, HMM-10-21, HMM-10-21UL, HMM-20-11, HMM-20-11UL, HMM-2-10-11, HMM-6-11, HMM-6-11UL, HMP-10-11, HMP-10-21, HMP-20-11, HMP-20-21, HMP-2-10-11, HMP-6-11 |                 |                     |

|  |                         |                 |                        |
|--|-------------------------|-----------------|------------------------|
|  <p>1</p> |                         |                 |                        |
| <b>GEV No.</b>   | 692101                  | <b>Ref. No.</b> | 12037114<br>RT20390331 |
| <b>description</b>   | cap D1 ø 19mm D2 ø 10mm |                 |                        |

|   |                            |                 |                       |
|---|----------------------------|-----------------|-----------------------|
|  |                            |                 |                       |
| <b>GEV No.</b>  | 699809                     | <b>Ref. No.</b> | 12037366<br>RT5000156 |
| <b>description</b>  | clamp for spray gun L 24mm |                 |                       |

|  |   |                 |                     |
|--|---|-----------------|---------------------|
|  <p>1</p> |   |                 |                     |
| <b>GEV No.</b>   | 696553  | <b>Ref. No.</b> | 12017801<br>Z883001 |
| <b>description</b>   | compression spring ø 7.5mm L 23mm wire gauge ø 0.7mm  |                 |                     |
| <b>For models:</b>   | ECO-280D, ECO-280I, ECO-370D, ECO-370I, ECO-460D, ECO-460I, ECO-550D, ECO-550I, FI-280D, FI-280I, FI-370D, FI-370I, FI-460D, FI-460I, FI-550D, FI-550I, HEI-10-11, HEI-20-11, HEI-6-11, HEM-10-11, HEM-20-11, HEM-6-11, HEP-10-11, HEP-20-11, HEP-6-11, HME-10-11, HME-10-21, HME-20-11, HME-20-21, HME-2-10-11, HME-2-20-11, HME-6-11, HMI-10-11, HMI-10-11UL, HMI-10-21, HMI-10-21UL, HMI-2-10-11, HMI-6-11, HMI-6-11UL, HMM-10-11, HMM-10-11UL, HMM-10-21, HMM-10-21UL, HMM-20-11, HMM-20-11UL, HMM-20-21, HMM-2-10-11, HMM-2-20-11, HMM-40-11-USMC... (Other models you can see in the webshop) |                 |                     |

|  |                     |                 |          |
|--|---------------------|-----------------|----------|
|  <p>1</p> |                     |                 |          |
| <b>GEV No.</b>   | 510559              | <b>Ref. No.</b> | 12034914 |
| <b>description</b>   | connection for pump |                 |          |

|   |  |                 |                     |
|---|--|-----------------|---------------------|
|  <p>1</p> |  |                 |                     |
| <b>GEV No.</b>  | 691878   | <b>Ref. No.</b> | 12011814<br>R722629 |
| <b>description</b>  | cover L 150mm  |                 |                     |
| <b>For models:</b>  | HMG-10-11, HMG-10-11UL, HMG-10-21, HMG-10-21UL, HMG-2-10-11, HVG-10-11, HVG-10-11UL, HVG-10-21, HVG-2-10-11, MFHVG-10-11 |                 |                     |

|   |  |                 |                       |
|---|--|-----------------|-----------------------|
|  <p>1</p> |  |                 |                       |
| <b>GEV No.</b>  | 702000   | <b>Ref. No.</b> | 12037186<br>RT1000357 |
| <b>description</b>  | cover cap for tray rack trolley D1 ø 20mm H 13.5mm D2 ø 26mm plastic Qty 5 pcs SCC-Linie 201/202 |                 |                       |

Зип Общежит

vsezip.ru

+7(812)987-08-81



1

|                    |   |                 |                     |
|--------------------|---|-----------------|---------------------|
| <b>GEV No.</b>     | 691690  | <b>Ref. No.</b> | 12020763<br>R725033 |
| <b>description</b> | disc D1 ø 65mm D2 ø 6.5mm brass thickness 2mm                         |                 |                     |
| <b>For models:</b> | HMG-10-11, HMG-10-11UL, HMG-10-21, HMG-10-21UL, HMG-2-10-11, HMG-6-11 |                 |                     |



1

|                    |   |                 |  |
|--------------------|---|-----------------|--|
| <b>GEV No.</b>     | 694651  | <b>Ref. No.</b> | 12031441<br>12032850<br>RT20050301<br>RT20050308 |
| <b>description</b> | filter for combi-steamer ø 97mm hole ø 6mm H 17.5mm |                 |  |



1

|                    |   |                 |                        |
|--------------------|---|-----------------|------------------------|
| <b>GEV No.</b>     | 694652  | <b>Ref. No.</b> | 12035010<br>RT20700050 |
| <b>description</b> | drain pipe angled D1 ø 54mm D2 ø 40mm L 95mm plastic H 95mm |                 |                        |



1

|                    |  |                 |  |
|--------------------|--|-----------------|--|
| <b>GEV No.</b>     | 691732                                 | <b>Ref. No.</b> | 12012292<br>12022207<br>R345120<br>T115105 |
| <b>description</b> | fixing plate bore ø 13mm L 54mm W 29mm |                 |  |



1

|                    |  |                 |                       |
|--------------------|--|-----------------|-----------------------|
| <b>GEV No.</b>     | 694391   | <b>Ref. No.</b> | 12034434<br>RT5000299 |
| <b>description</b> | drain pipe with sleeve for drip pan L 560mm PE |                 |                       |

|                    |  |  |  |
|--------------------|--|--|--|
| <b>For models:</b> | HEI-10-11, HEI-20-11, HEI-6-11, HEM-10-11, HEM-20-11, HEM-6-11, HEP-10-11, HEP-20-11, HEP-6-11, HME-10-11, HME-10-21, HME-20-11, HME-20-21, HME-2-10-11, HME-2-20-11, HME-6-11, HMI-10-11, HMI-10-11UL, HMI-10-21, HMI-10-21UL, HMI-2-10-11, HMI-6-11, HMI-6-11UL, HMM-10-11, HMM-10-11UL, HMM-10-21, HMM-10-21UL, HMM-20-11, HMM-20-11UL, HMM-20-21, HMM-20-21UL, HMM-2-10-11, HMM-2-20-11, HMM-40-11-USMC, HMM-6-11, HMM-6-11UL, HMP-10-11, HMP-10-21, HMP-20-11, HMP-20-21, HMP-2-10-11, HMP-2-20-11, HMP-6-11, MFHMM-20-11 |  |  |
|--------------------|--|--|--|



1

|                    |                                  |                 |                       |
|--------------------|----------------------------------|-----------------|-----------------------|
| <b>GEV No.</b>     | 524459                           | <b>Ref. No.</b> | 12033475<br>RT5000286 |
| <b>description</b> | drip rail L 540mm plastic W 63mm |                 |                       |

|                        |        |  |  |
|------------------------|--------|--|--|
| <b>accessories for</b> | 524459 |  |  |
|------------------------|--------|--|--|



|                    |  |                 |   |
|--------------------|--|-----------------|---|
| <b>GEV No.</b>     | 697931                                 | <b>Ref. No.</b> | — |
| <b>description</b> | mounting clip plastic W 20mm Qty 5 pcs |                 |   |



1

|                    |   |                 |          |
|--------------------|---|-----------------|----------|
| <b>GEV No.</b>     | 520917  | <b>Ref. No.</b> | 12034964 |
| <b>description</b> | gasket for heat exchanger D1 ø 104mm D2 ø 132mm |                 |          |



1

|                    |   |                 |                     |
|--------------------|---|-----------------|---------------------|
| <b>GEV No.</b>     | 691695                                    | <b>Ref. No.</b> | 12024231<br>R662813 |
| <b>description</b> | duct for flues D1 ø 80mm D2 ø 55mm rubber |                 |                     |

|                    |  |  |  |
|--------------------|--|--|--|
| <b>For models:</b> | ACE-061, ACE-101, ACE-102, ACE-201, ACG-061, ACG-101, ACG-102, ACG-201, AE-061, AE-061W, AE-101, AE-101W, AE-102, AE-102W, AE-201, AG-061, AG-061W, AG-101, AG-101W, AG-102, AG-102W, AG-201, APE-061, APE-061W, APE-101, APE-101W, APE-102, APE-102W, APE-201, APG-061, APG-061W, APG-101, APG-101W, APG-102, APG-102W, APG-201, COE-061, COE-101, COE-102, COE-201, COE-202, HEI-10-11, HEI-10-21, HEI-20-11, HEI-6-11, HEM-10-11, HEM-10-21, HEM-20-11, HEM-6-11, HEP-10-11...(Other models you can see in the webshop) |  |  |
|--------------------|--|--|--|

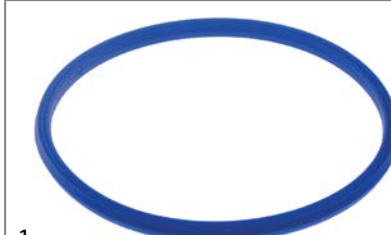

1

|                    |                        |                 |                        |
|--------------------|------------------------|-----------------|------------------------|
| <b>GEV No.</b>     | 694320                 | <b>Ref. No.</b> | 12034776<br>RT50120566 |
| <b>description</b> | gasket for lid ø 145mm |                 |                        |

Зип Общепит

vsezip.ru

+7(812)987-08-81



1

|                    |   |                 |                     |
|--------------------|---|-----------------|---------------------|
| <b>GEV No.</b>     | 692520  | <b>Ref. No.</b> | 12023750<br>T842809 |
| <b>description</b> | gutter for inner door plastic W 675mm FAGOR   |                 |                     |
| <b>For models:</b> | COE-061, COE-101, COG-061, COG-101, VE-061, VE-101, VG-101, VPE-061, VPE-101, VPG-101 |                 |                     |



1

|                    |                            |                 |                     |
|--------------------|----------------------------|-----------------|---------------------|
| <b>GEV No.</b>     | 691706                     | <b>Ref. No.</b> | 12016458<br>T075003 |
| <b>description</b> | heat exchanger complete SS |                 |                     |
| <b>For models:</b> | HMG-6-11                   |                 |                     |



1

|                    |   |                 |                        |
|--------------------|---|-----------------|------------------------|
| <b>GEV No.</b>     | 512184  | <b>Ref. No.</b> | 12032196<br>RT86641301 |
| <b>description</b> | hose connector plastic thread 3/4" Qty 1 pcs connection distance 60mm T-shape |                 |                        |



1

|                    |   |                 |                        |
|--------------------|---|-----------------|------------------------|
| <b>GEV No.</b>     | 694936  | <b>Ref. No.</b> | 12028877<br>RT50030300 |
| <b>description</b> | insulating mat for combi-steamer CPC-Linie L 1078mm W 635mm H 11mm foam Qty 2 pcs |                 |                        |



1

|                    |   |                 |  |
|--------------------|---|-----------------|--|
| <b>GEV No.</b>     | 691857  | <b>Ref. No.</b> | 12013749<br>12018338<br>12039157<br>R335030<br>R665046<br>T325040<br>T325077 |
| <b>description</b> | level tank L 178mm ø 75mm   |                 |  |
| <b>For models:</b> | HCV-5-11, HCV-6-11, HEM-10-11, HEM-10-21, HEM-20-11, HEM-20-21, HEM-6-11, HEP-10-11, HEP-10-21, HEP-20-11, HEP-20-21, HEP-6-11, HGP-10-21, HGP-20-21, HGV-10-11, HGV-10-21, HGV-20-11, HGV-20-21, HME-10-11, HME-10-21, HME-2-10-11, HME-6-11, HMM-6-11, HMM-6-11UL, HMP-10-11, HMP-10-21, HMP-2-10-11, HMP-6-11, HVG-10-11, HVG-10-11UL, HVG-10-21, HVG-10-21UL, HVG-20-11, HVG-20-21, HVG-2-10-11, HVG-2-20-21, MFHVG-10-11, MFHVG-10-21, VE-061, VE-101, VE-102, VE-201, VE-202, VPE-061, VPE-101, VPE-102, VPE-201, VPE-202 |                 |  |



1

|                    |  |                 |                     |
|--------------------|--|-----------------|---------------------|
| <b>GEV No.</b>     | 691677   | <b>Ref. No.</b> | 12012047<br>R025011 |
| <b>description</b> | level tank L 235mm SS ø 75mm   |                 |                     |
| <b>For models:</b> | HCV-10-11, HCV-10-21, HCV-2-10-21, HME-10-11, HME-10-21, HME-20-11, HME-20-21, HME-2-10-11, HME-2-20-11, HME-6-11, HMM-10-11, HMM-10-11UL, HMM-10-21, HMM-10-21UL, HMM-20-11, HMM-20-11UL, HMM-20-21, HMM-20-21UL, HMM-2-10-11, HMM-2-20-11, HMM-40-11-USMC, HMP-10-11, HMP-10-21, HMP-20-11, HMP-20-21, HMP-2-10-11, HMP-2-20-11, HMP-6-11, MFHMM-20-11 |                 |                     |

Зип Общепит

vsezip.ru

+7(812)987-08-81

|   |   |                 |                                 |
|---|---|-----------------|---------------------------------|
| 1   |   |                 |                                 |
|  |   |                 |                                 |
| <b>GEV No.</b>  | 698491  | <b>Ref. No.</b> | 12024419<br>12113061<br>T325079 |
| <b>description</b>  | level tank level control bore ø 17mm L 205mm thread M12 W 28mm ø 20.5mm H 80mm  |                 |                                 |
| <b>For models:</b>  | ACE-061, ACE-102, AE-061, AE-061W, AE-101, AE-101W, AE-102, AE-102W, AE-201, AE-202, AG-061, AG-061W, AG-101, AG-101W, AG-102, AG-102W, AG-201, AG-202, APE-061, APE-061W, APE-101, APE-101W, APE-102, APE-102W, APE-201, APE-202, APG-061, APG-061W, APG-101, APG-101W, APG-102, APG-102W, APG-201, APG-202, GA-20, GA-20D, GA-40, GA-40D, VE-061, VE-101, VE-102, VE-201, VE-202, VG-101, VG-102, VG-201, VG-202, VPE-061, VPE-101, VPE-102...(Other models you can see in the webshop) |                 |                                 |

|   |  |                 |                     |
|---|--|-----------------|---------------------|
| 1   |  |                 |                     |
|  |  |                 |                     |
| <b>GEV No.</b>  | 696427   | <b>Ref. No.</b> | 12009970<br>Q222011 |
| <b>description</b>  | rivet nut thread M5 DN 4mm L 12mm SS Qty 1 pcs ø 7mm WS 6  |                 |                     |
| <b>For models:</b>  | ACE-061, ACE-101, ACE-102, ACE-201, ACE-202, ACG-061, ACG-101, ACG-102, ACG-201, ACG-202, AD-45BBT, AD-48HY, AD-64BBT, AD-64BTDD, AD-64HY, AE-061, AE-061W, AE-101, AE-101W, AE-102, AE-102W, AE-201, AE-202, AG-061, AG-061W, AG-101, AG-101W, AG-102, AG-102W, AG-201, AG-202, APE-061, APE-061W, APE-101, APE-101W, APE-102, APE-102W, APE-201, APE-202, APG-061, APG-061W, APG-101, APG-101W, APG-102, APG-102W, APG-201, APG-202, CE9-40, CE9-41, CG-2000...(Other models you can see in the webshop) |                 |                     |

|  |  |                 |                        |
|--|--|-----------------|------------------------|
| 2  |  |                 |                        |
|  |  |                 |                        |
| <b>GEV No.</b>   | 512497   | <b>Ref. No.</b> | 12037410<br>RT20390350 |
| <b>description</b>   | protection cap for pulser suitable for combi-steamer CPC-Linie CPC/CM 61-202 D1 ø 13.5mm H 8.5mm D2 ø 6mm silicone |                 |                        |

|  |   |                 |                        |
|--|---|-----------------|------------------------|
| 1  |   |                 |                        |
|  |   |                 |                        |
| <b>GEV No.</b>   | 696393  | <b>Ref. No.</b> | 12027056<br>RT85141346 |
| <b>description</b>   | rotary nozzle for combi-steamer L 125mm stainless steel |                 |                        |

|   |   |                 |                     |
|---|---|-----------------|---------------------|
| 1   |   |                 |                     |
|  |   |                 |                     |
| <b>GEV No.</b>  | 691869  | <b>Ref. No.</b> | 12011086<br>R142614 |
| <b>description</b>  | protective plate for fan motor L 160mm  |                 |                     |
| <b>For models:</b>  | HCG-10-11, HCG-10-21, HCG-20-11, HCG-20-21, HCG-2-10-11, HCG-2-20-11, HCG-6-11, HGC-10-11, HGC-20-11, HGC-6-11, HGV-10-11, HGV-20-11, HME-20-21, HMM-20-21, HMM-40-11-USMC, HMP-20-21, HVG-10-11, HVG-10-11UL, HVG-10-21, HVG-10-21UL, HVG-20-11, HVG-20-21, HVG-2-10-11, HVG-2-20-21, MFHVG-10-11, MFHVG-10-21 |                 |                     |

|  |  |                 |                       |
|--|--|-----------------|-----------------------|
| 1  |  |                 |                       |
|  |  |                 |                       |
| <b>GEV No.</b>   | 694322   | <b>Ref. No.</b> | 12110550<br>RT5000303 |
| <b>description</b>   | sleeve for drip pan D1 ø 15mm D2 ø 20mm L 62mm |                 |                       |

|  |   |                 |                     |
|--|---|-----------------|---------------------|
| 1  |   |                 |                     |
|  |   |                 |                     |
| <b>GEV No.</b>   | 691734  | <b>Ref. No.</b> | 12020472<br>R675008 |
| <b>description</b>   | thread bolt for cavity degassing D1 ø 12mm L 58mm stainless steel thread M6   |                 |                     |
| <b>For models:</b>   | HEI-10-11, HEI-20-11, HEI-6-11, HEM-10-11, HEM-20-11, HEM-6-11, HEP-10-11, HEP-20-11, HEP-6-11, HME-10-11, HME-10-21, HME-20-11, HME-20-21, HME-2-10-11, HME-2-20-11, HME-6-11, HMI-10-11, HMI-10-11UL, HMI-10-21, HMI-10-21UL, HMI-2-10-11, HMI-6-11, HMI-6-11UL, HMM-10-11, HMM-10-11UL, HMM-10-21, HMM-10-21UL, HMM-20-11, HMM-20-11UL, HMM-20-21, HMM-20-21UL, HMM-2-10-11, HMM-2-20-11, HMM-40-11-USMC, HMM-6-11, HMM-6-11UL, HMP-10-11, HMP-10-21, HMP-20-11, HMP-20-21, HMP-2-10-11, HMP-2-20-11, HMP-6-11 |                 |                     |





Зип Общепит

vsezip.ru

+7(812)98



|                    |   |                 |                     |
|--------------------|---|-----------------|---------------------|
| <b>GEV No.</b>     | 691884  | <b>Ref. No.</b> | 12015187<br>R685003 |
| <b>description</b> | water pipe L 860mm  |                 |                     |
| <b>For models:</b> | HCG-10-21, HCG-20-21, HCG-2-10-11, HCG-2-20-11, HME-10-21, HME-20-21, HME-2-10-11, HME-2-20-11, HMG-10-21, HMG-10-21UL, HMG-2-10-11, HMI-10-21, HMI-10-21UL, HMI-2-10-11, HMM-10-21, HMM-10-21UL, HMM-2-10-11, HMP-10-21, HMP-20-21, HMP-2-10-11, HVG-10-21, HVG-10-21UL, MFHVG-10-21 |                 |                     |

|                        |  |                 |                        |
|------------------------|--|-----------------|------------------------|
| <b>GEV No.</b>         | 694402   | <b>Ref. No.</b> | 12033922<br>RT83541304 |
| <b>description</b>     | valve body for air valve hose ø 10mm                         |                 |                        |
| <b>accessories for</b> | 694402   |                 |                        |
|                        | <b>GEV No.</b>   | 694433          | <b>Ref. No.</b>        |
|                        |  |                 | 12036082<br>RT20690108 |
|                        | air valve for combi-steamer bore ø 2mm L 18mm plastic ø 20mm |                 |                        |



for tilting bratt pans housing and bezels



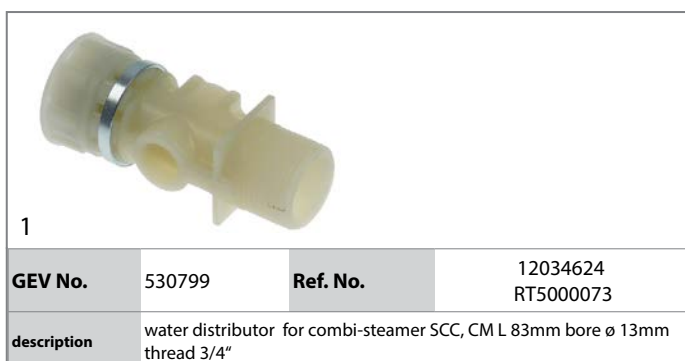

|                        |   |                 |                     |
|------------------------|---|-----------------|---------------------|
| <b>GEV No.</b>         | 210022  | <b>Ref. No.</b> | 12020193<br>U452805 |
| <b>description</b>     | cover L 177mm W 52mm H 16mm for control panel mounting pos. left suitable for 700 series  |                 |                     |
| <b>For models:</b>     | BG7-05, BG7-05I, BG7-10, BG7-10I, BME7-05, BME7-10, BMG7-10, CE7-20, CE7-40, CE7-41, CG7-10, CG7-11, CG7-20, CG-7200, CG7-40, CG-7400, CG7-41, CG-7415, CG7-61, CG-7615, CGB7-61, CGE7-41, CGE7-69, CPG7-05, EN7-05, EN7-10, FE-710, FE-720, FG-710, FG-720, FTE7-05, FTE7-05L, FTE7-05R, FTE7-10, FTE7-10L, FTE7-10L+R, FTE7-10R, FTEC7-05L, FTEC7-10L, FTG7-05, FTG7-05L, FTG7-05R, FTG7-05VL, FTG7-05VR, FTG7-10, FTG7-10L, FTG7-10L+R, FTG7-10R, FTG7-10VL, FTG7-10VL+R...(Other models you can see in the webshop) |                 |                     |
| <b>accessories for</b> | 210022  |                 |                     |
|                        | <b>GEV No.</b>  | 210021          | <b>Ref. No.</b>     |
|                        |   |                 | 12020194<br>U452804 |
|                        | cover L 177mm W 52mm H 16mm for control panel mounting pos. right suitable for 700 series   |                 |                     |

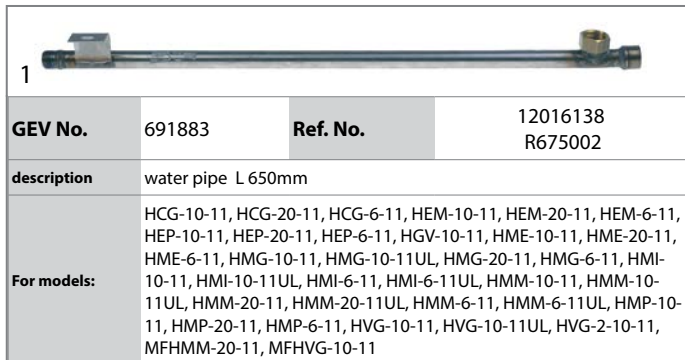

|                    |   |                 |                       |
|--------------------|---|-----------------|-----------------------|
| <b>GEV No.</b>     | 530799  | <b>Ref. No.</b> | 12034624<br>RT5000073 |
| <b>description</b> | water distributor for combi-steamer SCC, CM L 83mm bore ø 13mm thread 3/4"  |                 |                       |
| <b>For models:</b> | HCG-10-11, HCG-20-11, HCG-6-11, HEM-10-11, HEM-20-11, HEM-6-11, HEP-10-11, HEP-20-11, HEP-6-11, HGV-10-11, HME-10-11, HME-20-11, HME-6-11, HMG-10-11, HMG-10-11UL, HMG-20-11, HMG-6-11, HMI-10-11, HMI-10-11UL, HMI-6-11, HMI-6-11UL, HMM-10-11, HMM-10-11UL, HMM-20-11, HMM-20-11UL, HMM-6-11, HMM-6-11UL, HMP-10-11, HMP-20-11, HMP-6-11, HVG-10-11, HVG-10-11UL, HVG-2-10-11, MFHMM-20-11, MFHVG-10-11 |                 |                       |



|                    |   |                 |                     |
|--------------------|---|-----------------|---------------------|
| <b>GEV No.</b>     | 691883  | <b>Ref. No.</b> | 12016138<br>R675002 |
| <b>description</b> | water pipe L 650mm  |                 |                     |
| <b>For models:</b> | HCG-10-11, HCG-20-11, HCG-6-11, HEM-10-11, HEM-20-11, HEM-6-11, HEP-10-11, HEP-20-11, HEP-6-11, HGV-10-11, HME-10-11, HME-20-11, HME-6-11, HMG-10-11, HMG-10-11UL, HMG-20-11, HMG-6-11, HMI-10-11, HMI-10-11UL, HMI-6-11, HMI-6-11UL, HMM-10-11, HMM-10-11UL, HMM-20-11, HMM-20-11UL, HMM-6-11, HMM-6-11UL, HMP-10-11, HMP-20-11, HMP-6-11, HVG-10-11, HVG-10-11UL, HVG-2-10-11, MFHMM-20-11, MFHVG-10-11 |                 |                     |

|  |   |                 |                     |
|--|---|-----------------|---------------------|
|  |   |                 |                     |
| <b>GEV No.</b>   | 210021  | <b>Ref. No.</b> | 12020194<br>U452804 |
| <b>description</b>   | cover L 177mm W 52mm H 16mm for control panel mounting pos. right suitable for 700 series   |                 |                     |
| <b>For models:</b>   | BG7-05, BG7-05I, BG7-10, BG7-10I, BME7-05, BME7-10, BMG7-10, CE7-20, CE7-40, CE7-41, CG7-10, CG7-11, CG7-20, CG-7200, CG7-40, CG-7400, CG7-41, CG-7415, CG7-61, CG-7615, CGB7-61, CGE7-41, CGE7-62, CPG7-05, EN7-05, EN7-10, FE-710, FE-720, FG-710, FG-720, FTE7-05, FTE7-05L, FTE7-05R, FTE7-10, FTE7-10L, FTE7-10L+R, FTE7-10R, FTEC7-05L, FTEC7-10L, FTG7-05, FTG7-05L, FTG7-05R, FTG7-05VL, FTG7-05VR, FTG7-10, FTG7-10L, FTG7-10L+R, FTG7-10R, FTG7-10VL, FTG7-10VL+R...(Other models you can see in the webshop) |                 |                     |
| <b>accessories for</b>   | 210021  |                 |                     |
|  |   |                 |                     |
| <b>GEV No.</b>   | 210022  | <b>Ref. No.</b> | 12020193<br>U452805 |
| <b>description</b>   | cover L 177mm W 52mm H 16mm for control panel mounting pos. left suitable for 700 series  |                 |                     |

|   |  |                 |                     |
|---|--|-----------------|---------------------|
| <p>Reglado a BUTANO-PROPANO<br/>Reglage BUTANE-PROPANE<br/>Regulated for L.P.G. using</p> |  |                 |                     |
| <b>GEV No.</b>  | 691735   | <b>Ref. No.</b> | 12008203<br>U136501 |
| <b>description</b>  | sticker Regulated for L.P.G. using   |                 |                     |
| <b>For models:</b>  | BG7-05, BG7-05I, BG7-10, BG7-10I, BG9-05, BG9-05I, BG9-05PF, BG9-05PI, BG9-10, BG9-10I, BG9-10PF, BG9-10PI, BME9-05, BME9-05V-T, BME9-10, BME9-10V-T, BMG7-10, BMG9-05, BMG9-05V-T, BMG9-10, BMG9-10V-T, CG-1002, CG-1502, CG-2000, CG-2005, CG-210, CG-210G, CG-3005, CG-310, CG-310G, CG7-10, CG7-11, CG-7115, CG7-20, CG-7200, CG7-20H, CG7-30D, CG7-30I, CG7-31D, CG7-31I, CG7-40, CG-7400, CG7-40H, CG7-41, CG-7415, CG7-41H, CG7-50, CG7-51, CG7-61, CG-7615...(Other models you can see in the webshop) |                 |                     |

|  |   |                 |                     |
|--|---|-----------------|---------------------|
| <p>Reglado a GAS NATURAL<br/>Reglage GAZ NATUREL<br/>Regulated for NATURAL GAS using</p> |   |                 |                     |
| <b>GEV No.</b>   | 691736  | <b>Ref. No.</b> | 12008202<br>U134402 |
| <b>description</b>   | sticker regulated for NATURAL GAS using   |                 |                     |
| <b>For models:</b>   | BG7-05, BG7-05I, BG7-10, BG7-10I, BG9-05, BG9-05I, BG9-05PF, BG9-05PI, BG9-10, BG9-10I, BG9-10PF, BG9-10PI, BME9-05, BME9-05V-T, BME9-10, BME9-10V-T, BMG7-10, BMG9-05, BMG9-05V-T, BMG9-10, BMG9-10V-T, CG-1002, CG-1502, CG-2000, CG-2005, CG-210, CG-210G, CG-3005, CG-310, CG-310G, CG7-10, CG7-11, CG-7115, CG7-20, CG-7200, CG7-20H, CG7-30D, CG7-30I, CG7-31D, CG7-31I, CG7-40, CG-7400, CG7-40H, CG7-41, CG-7415, CG7-41H, CG7-50, CG7-51, CG7-61...(Other models you can see in the webshop) |                 |                     |

Зип Общежит

vsezip.ru

+7(812)987-08-81

|                    |   |                 |  |
|--------------------|---|-----------------|--|
| <b>GEV No.</b>     | 691691  | <b>Ref. No.</b> | 12009010<br>12009015<br>U022836<br>U262806 |
| <b>description</b> | type plate FAGOR metal  |                 |  |
| <b>For models:</b> | BG6-05I, BG7-05, BG7-05I, BG7-10, BG7-10I, BG9-05, BG9-05AD, BG9-05I, BG9-05PF, BG9-05PI, BG9-05PLUS-I, BG9-10, BG9-10AD, BG9-10I, BG9-10PF, BG9-10PI, BG9-10PLUS-I, BME6-05, BME7-05, BME7-10, BME9-05, BME9-05AD, BME9-05PLUS, BME9-05V-T, BME9-10, BME9-10AD, BME9-10PLUS, BME9-10V-T, BMG7-10, BMG9-05, BMG9-05V-T, BMG9-10, BMG9-10V-T, CE6-20, CE6-40, CE6-41, CE7-20, CE7-40, CE7-41, CE9-20, CE9-20AD, CE9-20PLUS, CE9-40, CE9-40AD, CE9-40PLUS, CE9-41, CE9-41AD, CE9-41PLUS, CG-1002, CG-1502...(Other models you can see in the webshop) |                 |  |

## spindles

|   |  |                 |                     |
|---|--|-----------------|---------------------|
|  |  |                 |                     |
| <b>GEV No.</b>  | 514183   | <b>Ref. No.</b> | 12008720<br>X156113 |
| <b>description</b>  | bearing block for spindle  |                 |                     |
| <b>For models:</b>  | SBE7-10, SBE9-10, SBE9-10I, SBE9-10I-AD, SBE9-10I-AD-S, SBE9-10IM, SBE9-10IMS, SBE9-10IS, SBE9-10PLUS-I, SBE9-10PLUS-SI, SBE9-10S, SBE9-10USMC, SBG7-10, SBG9-10, SBG9-10I, SBG9-10I-AD, SBG9-10I-AD-S, SBG9-10IS, SBG9-10PLUS-I, SBG9-10PLUS-SI, SBG9-10S |                 |                     |

|   |  |                 |                     |
|---|--|-----------------|---------------------|
|  |  |                 |                     |
| <b>GEV No.</b>  | 691699   | <b>Ref. No.</b> | 12009226<br>X156114 |
| <b>description</b>  | bearing block for spindle  |                 |                     |
| <b>For models:</b>  | SBE7-10, SBE9-10, SBE9-10I, SBE9-10I-AD, SBE9-10I-AD-S, SBE9-10IM, SBE9-10IMS, SBE9-10IS, SBE9-10PLUS-I, SBE9-10PLUS-SI, SBE9-10S, SBE9-10USMC, SBG7-10, SBG9-10, SBG9-10I, SBG9-10I-AD, SBG9-10I-AD-S, SBG9-10IS, SBG9-10PLUS-I, SBG9-10PLUS-SI, SBG9-10S |                 |                     |







|   |  |                 |                     |                     |
|---|--|-----------------|---------------------|---------------------|
|  |  |                 |                     |                     |
| <b>GEV No.</b>  | 514199   | <b>Ref. No.</b> | 12008106<br>X156115 |                     |
| <b>description</b>  | bush for spindle ID $\varnothing$ 18mm ED $\varnothing$ 30mm L 45mm  |                 |                     |                     |
| <b>For models:</b>  | SBE7-10, SBE9-10, SBE9-10I, SBE9-10I-AD, SBE9-10I-AD-S, SBE9-10IM, SBE9-10IMS, SBE9-10IS, SBE9-10PLUS-I, SBE9-10PLUS-SI, SBE9-10S, SBE9-10USMC, SBG7-10, SBG9-10, SBG9-10I, SBG9-10I-AD, SBG9-10I-AD-S, SBG9-10IS, SBG9-10PLUS-I, SBG9-10PLUS-SI, SBG9-10S |                 |                     |                     |
| <b>accessories for</b>  | 514199   |                 |                     |                     |
|  | <b>GEV No.</b>   | 514182          | <b>Ref. No.</b>     | 12019420<br>X156116 |
|   | spindle for spindle L 165mm  |                 |                     |                     |
|  | <b>GEV No.</b>   | 523536          | <b>Ref. No.</b>     | 12008262<br>X156125 |
|   | thrust ball bearing shaft $\varnothing$ 20mm ED $\varnothing$ 40mm W 14mm type 51204 DIN 711   |                 |                     |                     |

Table continues overleaf



|   |                       |                 |   |
|---|-----------------------|-----------------|---|
| <b>accessories for</b> 514199   |                       |                 |   |
|  | <b>GEV No.</b> 560028 | <b>Ref. No.</b> | — |
| cylinder head bolt thread M5 thread L 14mm WS 4 SS Qty 20 pcs DIN 912/ISO 4762    |                       |                 |   |

|  |  |                 |                     |
|--|--|-----------------|---------------------|
| <b>1</b>  |  |                 |                     |
| <b>GEV No.</b>   | 514182   | <b>Ref. No.</b> | 12019420<br>X156116 |
| <b>description</b>   | spindle for spindle L 165mm  |                 |                     |
| <b>For models:</b>   | SBE7-10, SBE9-10, SBE9-10I, SBE9-10IS, SBE9-10S, SBG7-10, SBG9-10, SBG9-10I, SBG9-10IS, SBG9-10S |                 |                     |
| <b>accessories for</b> 514182  |  |                 |                     |
|           | <b>GEV No.</b> 514199  | <b>Ref. No.</b> | 12008106<br>X156115 |
| bush for spindle ID ø 18mm ED ø 30mm L 45mm  |  |                 |                     |
|           | <b>GEV No.</b> 523536  | <b>Ref. No.</b> | 12008262<br>X156125 |
| thrust ball bearing shaft ø 20mm ED ø 40mm W 14mm type 51204 DIN 711                       |  |                 |                     |
|           | <b>GEV No.</b> 560028  | <b>Ref. No.</b> | —                   |
| cylinder head bolt thread M5 thread L 14mm WS 4 SS Qty 20 pcs DIN 912/ISO 4762             |  |                 |                     |

|  |                                       |                 |  |
|--|---------------------------------------|-----------------|--|
| <b>1</b>      |                                       |                 |  |
| <b>GEV No.</b>   | 691694                                | <b>Ref. No.</b> | 12017865<br>12040547<br>X266111<br>X266119 |
| <b>description</b>   | spindle L 470mm ø 26mm for 700 series |                 |  |
| <b>For models:</b>   | SBE7-10, SBG7-10                      |                 |  |
| <b>accessories for</b> 691694  |                                       |                 |  |
|             | <b>GEV No.</b> 691696                 | <b>Ref. No.</b> | 12017767<br>X156154                        |
| spindle nut thread TR26x8 right-hand thread W 60.6mm D 35mm H 35mm suitable for 700/900 series |                                       |                 |  |



|  |   |                 |                     |
|--|---|-----------------|---------------------|
| <b>1</b>  |   |                 |                     |
| <b>GEV No.</b>   | 514198  | <b>Ref. No.</b> | 12017861<br>X266101 |
| <b>description</b>   | spindle thread TR26x8 L 525mm ø 26mm total length 565mm for tilting bratt pan |                 |                     |
| <b>For models:</b>   | SBE7-10, SBG7-10  |                 |                     |

|  |   |                 |                     |
|--|---|-----------------|---------------------|
| <b>1</b>  |   |                 |                     |
| <b>GEV No.</b>   | 691696  | <b>Ref. No.</b> | 12017767<br>X156154 |
| <b>description</b>   | spindle nut thread TR26x8 right-hand thread W 60.6mm D 35mm H 35mm suitable for 700/900 series  |                 |                     |
| <b>For models:</b>   | SBE7-10, SBE9-10, SBE9-10I, SBE9-10IM, SBE9-10IMS, SBE9-10IS, SBE9-10M, SBE9-10MS, SBE9-10S, SBE9-10USMC, SBE9-15IM, SBE9-15IMS, SBG7-10, SBG9-10, SBG9-10I, SBG9-10IM, SBG9-10IMS, SBG9-10IS, SBG9-10M, SBG9-10MS, SBG9-10S, SBG9-15IM, SBG9-15IMS |                 |                     |

Зип Общепит

vsezip.ru

+7(812)987-08-81

|  |   |                 |  |
|--|---|-----------------|--|
| <b>1</b>     |   |                 |  |
| <b>GEV No.</b>   | 691692  | <b>Ref. No.</b> | 12040024<br>12040025<br>X026107<br>X156152 |
| <b>description</b>   | threaded rod L 610mm ø 26mm for 900 series  |                 |  |
| <b>For models:</b>   | SBE9-10, SBE9-10I, SBE9-10IM, SBE9-10IMS, SBE9-10IS, SBE9-10M, SBE9-10MS, SBE9-10S, SBE9-10USMC, SBE9-15IM, SBE9-15IMS, SBG9-10, SBG9-10I, SBG9-10IM, SBG9-10IMS, SBG9-10IS, SBG9-10M, SBG9-10MS, SBG9-10S, SBG9-15IM, SBG9-15IMS |                 |  |
| <b>accessories for</b> 691692  |   |                 |  |
|               | <b>GEV No.</b> 691696   | <b>Ref. No.</b> | 12017767<br>X156154                        |
| spindle nut thread TR26x8 right-hand thread W 60.6mm D 35mm H 35mm suitable for 700/900 series |   |                 |  |

|   |   |                 |                                 |
|---|---|-----------------|---------------------------------|
| <b>1</b>  |   |                 |                                 |
| <b>GEV No.</b>  | 692535                                      | <b>Ref. No.</b> | 12009467<br>12046631<br>X146138 |
| <b>description</b>  | threaded rod L 620mm ø 26mm TR26x5 complete |                 |                                 |

sumps

|   |  |                 |                     |
|---|--|-----------------|---------------------|
| <b>1</b>  |  |                 |                     |
| <b>GEV No.</b>  | 691900   | <b>Ref. No.</b> | 12009590<br>X286111 |
| <b>description</b>  | sump for tilting bratt pan L 1260mm W 700mm H 200mm stainless steel                      |                 |                     |
| <b>For models:</b>  | SBE9-10IM, SBE9-10IMS, SBE9-10M, SBE9-10MS, SBE9-15IM, SBE9-15IMS, SBG9-15IM, SBG9-15IMS |                 |                     |

|   |  |                 |                     |
|---|--|-----------------|---------------------|
| <b>1</b>  |  |                 |                     |
| <b>GEV No.</b>  | 691898   | <b>Ref. No.</b> | 12007698<br>X146125 |
| <b>description</b>  | sump for tilting bratt pan L 840mm W 700mm cast iron since July 2002   |                 |                     |
| <b>For models:</b>  | SBE9-10, SBE9-10I, SBE9-10IM, SBE9-10IMS, SBE9-10IS, SBE9-10M, SBE9-10MS, SBE9-10S, SBE9-15IM, SBE9-15IMS, SBG9-10, SBG9-10IM, SBG9-10IMS, SBG9-10M, SBG9-10MS, SBG9-10S |                 |                     |

Зип-Общепит

for boiling pans

vsezip.ru

7(812)987-08-81

spare parts and accessories

1

|                |        |                 |          |
|----------------|--------|-----------------|----------|
| <b>GEV No.</b> | 691650 | <b>Ref. No.</b> | 12019228 |
|----------------|--------|-----------------|----------|

|                    |   |
|--------------------|---|
| <b>description</b> | connecting fitting brass L 52mm W 30mm H 30mm |
|--------------------|---|



1

|                |        |                 |          |
|----------------|--------|-----------------|----------|
| <b>GEV No.</b> | 691651 | <b>Ref. No.</b> | 12020990 |
|----------------|--------|-----------------|----------|

|                    |  |
|--------------------|--|
| <b>description</b> | threaded part brass L 27mm ID ø 12.4mm thread 1/2" |
|--------------------|--|

## filters



1

|                |        |                 |                     |
|----------------|--------|-----------------|---------------------|
| <b>GEV No.</b> | 514159 | <b>Ref. No.</b> | 12014430<br>S316120 |
|----------------|--------|-----------------|---------------------|

|                    |                         |
|--------------------|-------------------------|
| <b>description</b> | drain filter for kettle |
|--------------------|-------------------------|

|                    |                            |
|--------------------|----------------------------|
| <b>For models:</b> | ME7-10BM, MG7-10, MG7-10BM |
|--------------------|----------------------------|



1

|                |        |                 |                        |
|----------------|--------|-----------------|------------------------|
| <b>GEV No.</b> | 514503 | <b>Ref. No.</b> | 12031575<br>FX30700122 |
|----------------|--------|-----------------|------------------------|

|                    |                                       |
|--------------------|---------------------------------------|
| <b>description</b> | drain filter for kettle size 76x145mm |
|--------------------|---------------------------------------|



1

|                    |  |                 |                     |
|--------------------|--|-----------------|---------------------|
| <b>GEV No.</b>     | 691899   | <b>Ref. No.</b> | 12010883<br>X146116 |
| <b>description</b> | sump for tilting bratt pan L 840mm W 700mm cast iron until June 2002 |                 |                     |
| <b>For models:</b> | SBE9-10, SBE9-10M, SBE9-10MS, SBE9-10S, SBG9-10M, SBG9-10MS          |                 |                     |



1

|                    |   |                 |   |
|--------------------|---|-----------------|---|
| <b>GEV No.</b>     | 691897  | <b>Ref. No.</b> | 12009588<br>12016309<br>12016311<br>X146133<br>X156150<br>X156168 |
| <b>description</b> | sump for tilting bratt pan L 840mm W 700mm stainless steel  |                 |   |
| <b>For models:</b> | SBE9-10I, SBE9-10IM, SBE9-10IMS, SBE9-10IS, SBE9-10M, SBE9-10MS, SBE9-15IM, SBE9-15IMS, SBG9-10, SBG9-10I, SBG9-10IM, SBG9-10IMS, SBG9-10IS, SBG9-10M, SBG9-10MS, SBG9-10S, SBG9-15IM, SBG9-15IMS |                 |   |

## miscellaneous



1

|                    |   |                 |                     |
|--------------------|---|-----------------|---------------------|
| <b>GEV No.</b>     | 505335  | <b>Ref. No.</b> | 12009773<br>X109550 |
| <b>description</b> | bushing L 30mm ø 22/28mm for tilting bratt pan brass  |                 |                     |
| <b>For models:</b> | SBE7-10, SBE9-10, SBE9-10I, SBE9-10I-AD, SBE9-10I-AD-S, SBE9-10IM, SBE9-10IM-AD, SBE9-10IM-AD-S, SBE9-10IMS, SBE9-10IS, SBE9-10M, SBE9-10MS, SBE9-10PLUS-I, SBE9-10PLUS-IM, SBE9-10PLUS-SI, SBE9-10PLUS-SIM, SBE9-10S, SBE9-10USMC, SBE9-15IM, SBE9-15IM-AD, SBE9-15IM-AD-S, SBE9-15IMS, SBE9-15PLUS-IM, SBE9-15PLUS-SIM, SBG7-10, SBG-9040, SBG9-10, SBG9-10I, SBG9-10I-AD, SBG9-10I-AD-S, SBG9-10IM, SBG9-10IM-AD, SBG9-10IM-AD-S, SBG9-10IMS, SBG9-10IS, SBG9-10M, SBG9-10MS, SBG9-10PLUS-I, SBG9-10PLUS-IM, SBG9-10PLUS-SI, SBG9-10PLUS-SIM, SBG9-10S, SBG9-15IM, SBG9-15IM-AD, SBG9-15IM-AD-S, SBG9-15IMS, SBG9-15PLUS-IM, SBG9-15PLUS-SIM |                 |                     |



1

|                    |  |                 |                     |
|--------------------|--|-----------------|---------------------|
| <b>GEV No.</b>     | 514427   | <b>Ref. No.</b> | 12002206<br>X152679 |
| <b>description</b> | fastening angle L 46mm for tilting bratt pan W 24mm H 25mm thickness 2mm   |                 |                     |
| <b>For models:</b> | SBG7-10, SBG9-10, SBG9-10I, SBG9-10IM, SBG9-10IMS, SBG9-10IS, SBG9-10M, SBG9-10MS, SBG9-10S, SBG9-15IM, SBG9-15IMS |                 |                     |



Зип Общепит

vsezip.ru

+7(812)987-08-81



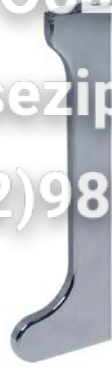

|                    |  |                 |                          |
|--------------------|--|-----------------|--------------------------|
| <b>GEV No.</b>     | 514338                                 | <b>Ref. No.</b> | 12031318<br>ICRE32300340 |
| <b>description</b> | drain filter size 12,5x24mm for kettle |                 |                          |





|   |   |                 |                     |                     |
|---|---|-----------------|---------------------|---------------------|
| <b>GEV No.</b>  | 210021  | <b>Ref. No.</b> | 12020194<br>U452804 |                     |
| <b>description</b>  | cover L 177mm W 52mm H 16mm for control panel mounting pos. right suitable for 700 series   |                 |                     |                     |
| <b>For models:</b>  | BG7-05, BG7-05I, BG7-10, BG7-10I, BME7-05, BME7-10, BMG7-10, CE7-20, CE7-40, CE7-41, CG7-10, CG7-11, CG7-20, CG-7200, CG7-40, CG-7400, CG7-41, CG-7415, CG7-61, CG-7615, CGB7-61, CGE7-41, CGE7-62, CPG7-05, EN7-05, EN7-10, FE-710, FE-720, FG-710, FG-720, FTE7-05, FTE7-05L, FTE7-05R, FTE7-10, FTE7-10L, FTE7-10L+R, FTE7-10R, FTEC7-05L, FTEC7-10L, FTG7-05, FTG7-05L, FTG7-05R, FTG7-05VL, FTG7-05VR, FTG7-10, FTG7-10L, FTG7-10L+R, FTG7-10R, FTG7-10VL, FTG7-10VL+R...(Other models you can see in the webshop) |                 |                     |                     |
| <b>accessories for</b>  | 210021  |                 |                     |                     |
|  | <b>GEV No.</b>  | 210022          | <b>Ref. No.</b>     | 12020193<br>U452805 |
|   | cover L 177mm W 52mm H 16mm for control panel mounting pos. left suitable for 700 series  |                 |                     |                     |

housing and bezels



|   |   |                 |                     |                     |
|---|---|-----------------|---------------------|---------------------|
| <b>GEV No.</b>  | 210022  | <b>Ref. No.</b> | 12020193<br>U452805 |                     |
| <b>description</b>  | cover L 177mm W 52mm H 16mm for control panel mounting pos. left suitable for 700 series  |                 |                     |                     |
| <b>For models:</b>  | BG7-05, BG7-05I, BG7-10, BG7-10I, BME7-05, BME7-10, BMG7-10, CE7-20, CE7-40, CE7-41, CG7-10, CG7-11, CG7-20, CG-7200, CG7-40, CG-7400, CG7-41, CG-7415, CG7-61, CG-7615, CGB7-61, CGE7-41, CGE7-69, CPG7-05, EN7-05, EN7-10, FE-710, FE-720, FG-710, FG-720, FTE7-05, FTE7-05L, FTE7-05R, FTE7-10, FTE7-10L, FTE7-10L+R, FTE7-10R, FTEC7-05L, FTEC7-10L, FTG7-05, FTG7-05L, FTG7-05R, FTG7-05VL, FTG7-05VR, FTG7-10, FTG7-10L, FTG7-10L+R, FTG7-10R, FTG7-10VL, FTG7-10VL+R...(Other models you can see in the webshop) |                 |                     |                     |
| <b>accessories for</b>  | 210022  |                 |                     |                     |
|  | <b>GEV No.</b>  | 210021          | <b>Ref. No.</b>     | 12020194<br>U452804 |
|   | cover L 177mm W 52mm H 16mm for control panel mounting pos. right suitable for 700 series   |                 |                     |                     |

|   |   |                 |                     |                     |
|---|---|-----------------|---------------------|---------------------|
| <b>GEV No.</b>  | 210021  | <b>Ref. No.</b> | 12020194<br>U452804 |                     |
| <b>description</b>  | cover L 177mm W 52mm H 16mm for control panel mounting pos. right suitable for 700 series   |                 |                     |                     |
| <b>For models:</b>  | BG7-05, BG7-05I, BG7-10, BG7-10I, BME7-05, BME7-10, BMG7-10, CE7-20, CE7-40, CE7-41, CG7-10, CG7-11, CG7-20, CG-7200, CG7-40, CG-7400, CG7-41, CG-7415, CG7-61, CG-7615, CGB7-61, CGE7-41, CGE7-62, CPG7-05, EN7-05, EN7-10, FE-710, FE-720, FG-710, FG-720, FTE7-05, FTE7-05L, FTE7-05R, FTE7-10, FTE7-10L, FTE7-10L+R, FTE7-10R, FTEC7-05L, FTEC7-10L, FTG7-05, FTG7-05L, FTG7-05R, FTG7-05VL, FTG7-05VR, FTG7-10, FTG7-10L, FTG7-10L+R, FTG7-10R, FTG7-10VL, FTG7-10VL+R...(Other models you can see in the webshop) |                 |                     |                     |
| <b>accessories for</b>  | 210021  |                 |                     |                     |
|  | <b>GEV No.</b>  | 210022          | <b>Ref. No.</b>     | 12020193<br>U452805 |
|   | cover L 177mm W 52mm H 16mm for control panel mounting pos. left suitable for 700 series  |                 |                     |                     |



|                    |  |                 |                     |
|--------------------|--|-----------------|---------------------|
| <b>GEV No.</b>     | 700809   | <b>Ref. No.</b> | 12007564<br>R205409 |
| <b>description</b> | fastening angle L 120mm W 67mm H 28mm  |                 |                     |
| <b>For models:</b> | BG9-05, BG9-10, BME9-05, BME9-10, BMG9-05, BMG9-10, CE9-20, CE9-40, CE9-41, CG9-10, CG9-11, CG9-20, CG9-40, CG9-41, CG9-60, CG9-61, CG9-82, EN9-05, EN9-10, FE-920, FG-920, FG-940, FTE9-05L, FTE9-05R, FTE9-10L, FTE9-10L+R, FTE9-10R, FTEC9-05, FTEC9-05L, FTEC9-05R, FTEC9-10, FTEC9-10L, FTEC9-10L+R, FTEC9-10R, FTG9-05L, FTG9-05R, FTG9-05VL, FTG9-05VR, FTG9-10L, FTG9-10L+R, FTG9-10R, FTG9-10VL, FTG9-10VL+R, FTG9-10VR, FTGC9-05, FTGC9-05L, FTGC9-05R, FTGC9-10, FTGC9-10L, FTGC9-10L+R...(Other models you can see in the webshop) |                 |                     |



|                    |  |                 |                     |
|--------------------|--|-----------------|---------------------|
| <b>GEV No.</b>     | 691702                                   | <b>Ref. No.</b> | 12011406<br>S312613 |
| <b>description</b> | front panel W 110mm H 70mm thickness 1mm |                 |                     |
| <b>For models:</b> | MG7-10, MG7-10BM                         |                 |                     |

Зип.Общепит

glass panels

vsezip.ru

+7(812)987-08-81

|   |                                       |                 |                     |
|---|---------------------------------------|-----------------|---------------------|
|  |                                       |                 |                     |
| 1   |                                       |                 |                     |
| <b>GEV No.</b>  | 691711                                | <b>Ref. No.</b> | 12012336<br>S312614 |
| <b>description</b>  | front panel W 457mm H 80mm for kettle |                 |                     |
| <b>For models:</b>  | MG7-10, MG7-10BM                      |                 |                     |

|                    |  |                 |                     |
|--------------------|--|-----------------|---------------------|
| <b>GEV No.</b>     | 692158   | <b>Ref. no.</b> | 12008981<br>9294600 |
| <b>description</b> | glass panel ø 29.5mm thickness 5mm   |                 |                     |
| <b>For models:</b> | FE-18, FE-25, FGCL9-05, MG7-10, MG7-10BM, MG9-10, MG9-10AD, MG9-10BM, MG9-10BMAD, MG9-10BMS, MG9-10BMSAD, MG9-10PLUS, MG9-10PLUS-BM, MG9-10PLUS-BMS, MG9-10PLUS-S, MG9-10S, MG9-10S-AD, MG9-15, MG-9150BM, MG9-15AD, MG9-15BM, MG9-15BM316, MG9-15BMAD, MG9-15BMS, MG9-15BMSAD, MG9-15PLUS, MG9-15PLUS-BM, MG9-15PLUS-BMS, MG9-15PLUS-S, MG9-15S, MG9-15S-AD, MG9-20, MG9-20AD, MG9-20PLUS, MG9-20PLUS-S, MG9-20S, MG9-20S-AD, MPG9-10, MPG9-10BM, MPG9-10BMS, MPG9-10S, MPG9-15, MPG9-15BM, MPG9-15BMS, MPG9-15S, MPG9-20, MPG9-20S |                 |                     |

|  |   |                 |                     |
|--|---|-----------------|---------------------|
|  |   |                 |                     |
| 1  |   |                 |                     |
| <b>GEV No.</b>   | 104123  | <b>Ref. No.</b> | 12013999<br>U742640 |
| <b>description</b>   | mounting plate for gas range L 690mm W 110mm H 25mm                       |                 |                     |
| <b>For models:</b>   | CE7-41, CG7-11, CG7-41, CGE7-41, FE-720, FG-720, MB7-10, MG7-10, MG7-10BM |                 |                     |

|   |  |                 |                     |
|---|--|-----------------|---------------------|
| <b>level glasses</b>  |  |                 |                     |
| <b>components</b>   |  |                 |                     |
| <b>gaskets</b>  |  |                 |                     |
|  |  |                 |                     |
| 1   |  |                 |                     |
| <b>GEV No.</b>  | 691010   | <b>Ref. No.</b> | 12010108<br>Q307069 |
| <b>description</b>  | O-ring thickness 2.62mm ID ø 12.37mm Qty 1 pcs for water level tube  |                 |                     |
| <b>For models:</b>  | ME9-10BM, ME9-10BMS, ME9-15BM, ME9-15BM316, ME9-15BMS, MG9-10BM, MG9-10BMS, MG9-15BM, MG9-15BM316, MG9-15BMS, MPE9-10BM, MPE9-10BMS, MPE9-15BM, MPE9-15BMS, MPG9-10BM, MPG9-10BMS, MPG9-15BM, MPG9-15BMS |                 |                     |

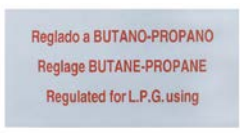
|   |  |                 |                     |
|---|--|-----------------|---------------------|
|  |  |                 |                     |
| 1   |  |                 |                     |
| <b>GEV No.</b>  | 691735   | <b>Ref. No.</b> | 12008203<br>U136501 |
| <b>description</b>  | sticker Regulated for L.P.G. using   |                 |                     |
| <b>For models:</b>  | BG7-05, BG7-05I, BG7-10, BG7-10I, BG9-05, BG9-05I, BG9-05PF, BG9-05PI, BG9-10, BG9-10I, BG9-10PF, BG9-10PI, BME9-05, BME9-05V-T, BME9-10, BME9-10V-T, BMG7-10, BMG9-05, BMG9-05V-T, BMG9-10, BMG9-10V-T, CG-1002, CG-1502, CG-2000, CG-200S, CG-210, CG-210G, CG-300S, CG-310, CG-310G, CG7-10, CG7-11, CG-7115, CG7-20, CG-7200, CG7-20H, CG7-30D, CG7-30I, CG7-31D, CG7-31I, CG7-40, CG-7400, CG7-40H, CG7-41, CG-7415, CG7-41H, CG7-50, CG7-51, CG7-61, CG-7615...(Other models you can see in the webshop) |                 |                     |

|  |  |                 |                     |
|--|--|-----------------|---------------------|
| <b>level glass pipes</b>   |  |                 |                     |
|  |  |                 |                     |
| 1  |  |                 |                     |
| <b>GEV No.</b>   | 691071   | <b>Ref. No.</b> | 12008327<br>S042102 |
| <b>description</b>   | water level tube D1 ø 13mm D2 ø 8.6mm L 138.5mm marking red/blue   |                 |                     |
| <b>For models:</b>   | ME9-10BM, ME9-10BMS, ME9-15BM, ME9-15BM316, ME9-15BMS, MG9-10BM, MG9-10BMS, MG9-15BM, MG9-15BM316, MG9-15BMS, MPE9-10BM, MPE9-10BMS, MPE9-15BM, MPE9-15BMS, MPG9-10BM, MPG9-10BMS, MPG9-15BM, MPG9-15BMS |                 |                     |

|   |   |                 |                     |
|---|---|-----------------|---------------------|
|  |   |                 |                     |
| 1   |   |                 |                     |
| <b>GEV No.</b>  | 691736  | <b>Ref. No.</b> | 12008202<br>U134402 |
| <b>description</b>  | sticker regulated for NATURAL GAS using   |                 |                     |
| <b>For models:</b>  | BG7-05, BG7-05I, BG7-10, BG7-10I, BG9-05, BG9-05I, BG9-05PF, BG9-05PI, BG9-10, BG9-10I, BG9-10PF, BG9-10PI, BME9-05, BME9-05V-T, BME9-10, BME9-10V-T, BMG7-10, BMG-9045, BMG9-05, BMG9-05V-T, BMG9-10, BMG9-10V-T, CG-1002, CG-1502, CG-2000, CG-200S, CG-210, CG-210G, CG-300S, CG-310, CG-310G, CG7-10, CG7-11, CG-7115, CG7-20, CG-7200, CG7-20H, CG7-30D, CG7-30I, CG7-31D, CG7-31I, CG7-40, CG-7400, CG7-40H, CG7-41, CG-7415, CG7-41H, CG7-50, CG7-51, CG7-61...(Other models you can see in the webshop) |                 |                     |

Зип Общепит

vsezip.ru

+7(812)987-08-81

screw connections



1

|                    |  |                 |                     |
|--------------------|--|-----------------|---------------------|
| <b>GEV No.</b>     | 691072   | <b>Ref. No.</b> | 12008966<br>S042101 |
| <b>description</b> | connection angle for water level tube thread 3/8" brass hole ø 13.5mm  |                 |                     |
| <b>For models:</b> | ME9-10BM, ME9-10BMS, ME9-15BM, ME9-15BM316, ME9-15BMS, MG9-10BM, MG9-10BMS, MG9-15BM, MG9-15BM316, MG9-15BMS, MPE9-10BM, MPE9-10BMS, MPE9-15BM, MPE9-15BMS, MPG9-10BM, MPG9-10BMS, MPG9-15BM, MPG9-15BMS |                 |                     |

sumps



1

|                    |  |                 |                     |
|--------------------|--|-----------------|---------------------|
| <b>GEV No.</b>     | 691896   | <b>Ref. No.</b> | 12016271<br>S226102 |
| <b>description</b> | sump for kettle ID ø 680mm H 550mm L 850mm W 750mm stainless steel |                 |                     |
| <b>For models:</b> | MG9-15BM, MG9-15BMS  |                 |                     |

complete



1

|                    |  |                 |                     |
|--------------------|--|-----------------|---------------------|
| <b>GEV No.</b>     | 691031   | <b>Ref. No.</b> | 12000135<br>S082100 |
| <b>description</b> | water level tube complete  |                 |                     |
| <b>For models:</b> | ME9-10BM, ME9-10BMS, ME9-15BM, ME9-15BMS, MG9-10BM, MG9-10BMS, MG9-15BM, MG9-15BMS, MPE9-10BM, MPE9-10BMS, MPE9-15BM, MPE9-15BMS, MPG9-10BM, MPG9-10BMS, MPG9-15BM, MPG9-15BMS |                 |                     |

for pasta cookers

spare parts and accessories

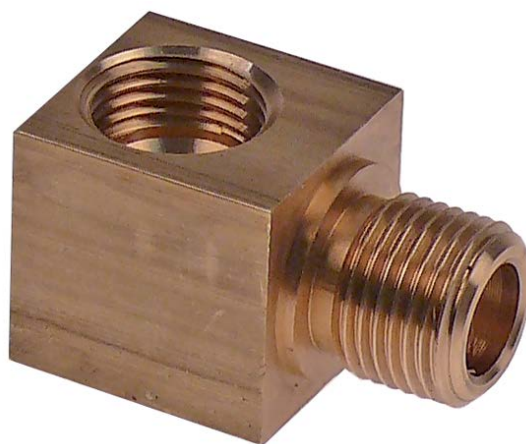

1

|                    |   |                 |          |
|--------------------|---|-----------------|----------|
| <b>GEV No.</b>     | 691650  | <b>Ref. No.</b> | 12019228 |
| <b>description</b> | connecting fitting brass L 52mm W 30mm H 30mm |                 |          |

accessories



1

|                    |  |                 |                     |
|--------------------|--|-----------------|---------------------|
| <b>GEV No.</b>     | 691070   | <b>Ref. No.</b> | 12004490<br>S042647 |
| <b>description</b> | protector for level glass  |                 |                     |
| <b>For models:</b> | ME9-10BM, ME9-10BMS, ME9-15BM, ME9-15BM316, ME9-15BMS, MG9-10BM, MG9-10BMS, MG9-15BM, MG9-15BM316, MG9-15BMS, MPE9-10BM, MPE9-10BMS, MPE9-15BM, MPE9-15BMS, MPG9-10BM, MPG9-10BMS, MPG9-15BM, MPG9-15BMS |                 |                     |



1

|                    |  |                 |          |
|--------------------|--|-----------------|----------|
| <b>GEV No.</b>     | 691651   | <b>Ref. No.</b> | 12020990 |
| <b>description</b> | threaded part brass L 27mm ID $\varnothing$ 12.4mm thread 1/2" |                 |          |

## for ovens

## spare parts and accessories



1

|                    |                              |                 |                     |
|--------------------|------------------------------|-----------------|---------------------|
| <b>GEV No.</b>     | 691703                       | <b>Ref. No.</b> | 12019787<br>U125409 |
| <b>description</b> | distance washer for handrail |                 |                     |
| <b>For models:</b> | CG-HP-20, FI-5420, FI-7630   |                 |                     |



1

|                    |   |                 |            |
|--------------------|---|-----------------|------------|
| <b>GEV No.</b>     | 691707  | <b>Ref. No.</b> | FAG6000009 |
| <b>description</b> | distance washer SS H 10mm ID $\varnothing$ 18mm ext. $\varnothing$ 16 |                 |            |



1

|                    |  |                 |           |
|--------------------|--|-----------------|-----------|
| <b>GEV No.</b>     | 691676                                       | <b>Ref. No.</b> | FAG600008 |
| <b>description</b> | hanging bracket SS L 350mm $\varnothing$ 8mm |                 |           |

Зип Общепит

vsezip.ru

+7(812)987-08-81

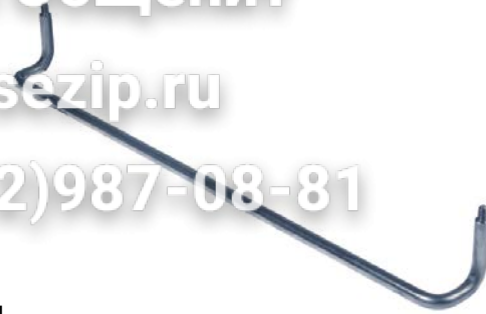

1

|                    |  |                 |           |
|--------------------|--|-----------------|-----------|
| <b>GEV No.</b>     | 691675                                       | <b>Ref. No.</b> | FAG600007 |
| <b>description</b> | hanging bracket SS L 383mm $\varnothing$ 8mm |                 |           |



1

|                |        |                 |                     |
|----------------|--------|-----------------|---------------------|
| <b>GEV No.</b> | 691683 | <b>Ref. No.</b> | 12007464<br>R152607 |
|----------------|--------|-----------------|---------------------|

**description** holding plate for drain L 110mm W 60mm ID  $\varnothing$  48mm

**For models:** CG9-51L, CG9-51LC, CG9-51R, CG9-51RC, FTE7-05, FTE7-05L, FTE7-05R, FTE7-10, FTE7-10L, FTE7-10L+R, FTE7-10R, FTE9-05L, FTE9-05R, FTE9-10L, FTE9-10L+R, FTE9-10R, FTEC7-05L, FTEC7-10L, FTEC9-05L, FTEC9-05R, FTEC9-05USMC, FTEC9-10L, FTEC9-10L+R, FTEC9-10R, FTEC9-10USMC, FTG7-05, FTG7-05L, FTG7-05R, FTG7-05VL, FTG7-05VR, FTG7-10, FTG7-10L, FTG7-10L+R, FTG7-10R, FTG7-10VL, FTG7-10VL+R, FTG7-10VR, FTG9-05L, FTG9-05R, FTG9-05VL, FTG9-05VR, FTG9-10L, FTG9-10L+R, FTG9-10R, FTG9-10VL, FTG9-10VL+R, FTG9-10VR, FTG9-11L, FTG9-11L+R, FTG9-11R...(Other models you can see in the webshop)

## housing and bezels



1

|                |        |                 |                     |
|----------------|--------|-----------------|---------------------|
| <b>GEV No.</b> | 691722 | <b>Ref. No.</b> | 12004214<br>R062811 |
|----------------|--------|-----------------|---------------------|

**description** back panel chargin grill

**For models:** BG9-05AD, BG9-05PF, BG9-05PI, BG9-05PLUS-I, BG9-10AD, BG9-10PF, BG9-10PI, BG9-10PLUS-I, BME9-05, BME9-05AD, BME9-05PLUS, BME9-05V-T, BME9-10, BME9-10AD, BME9-10PLUS, BME9-10V-T, BMG9-05, BMG9-05V-T, BMG9-10, BMG9-10V-T, CE9-20, CE9-20AD, CE9-20PLUS, CE9-40, CE9-40AD, CE9-40PLUS, CG9-05AD, CG9-05PLUS, CG9-10, CG9-10AD, CG9-10PLUS, CG9-20, CG9-20AD, CG9-20AD-H, CG9-20H, CG9-20PLUS, CG9-20PLUS-H, CG9-40, CG9-40AD, CG9-40AD-H, CG9-40H, CG9-40PLUS, CG9-40PLUS-H, CG9-60, CG9-60AD, CG9-60AD-H, CG9-60H, CG9-60PLUS, CG9-60PLUS-H, CGF9-120D...(Other models you can see in the webshop)



Зип Общепит

vsezip.ru

+7(812)987-08-81





1

|   |   |                 |                     |
|---|---|-----------------|---------------------|
| <b>GEV No.</b>  | 210022  | <b>Ref. No.</b> | 12020193<br>U452805 |
| <b>description</b>  | cover L 177mm W 52mm H 16mm for control panel mounting pos. left suitable for 700 series  |                 |                     |
| <b>For models:</b>  | BG7-05, BG7-05I, BG7-10, BG7-10I, BME7-05, BME7-10, BMG7-10, CE7-20, CE7-40, CE7-41, CG7-10, CG7-11, CG7-20, CG-7200, CG7-40, CG-7400, CG7-41, CG-7415, CG7-61, CG-7615, CGB7-61, CGE7-41, CGE7-69, CPG7-05, EN7-05, EN7-10, FE-710, FE-720, FG-710, FG-720, FTE7-05, FTE7-05L, FTE7-05R, FTE7-10, FTE7-10L, FTE7-10L+R, FTE7-10R, FTEC7-05L, FTEC7-10L, FTG7-05, FTG7-05L, FTG7-05R, FTG7-05VL, FTG7-05VR, FTG7-10, FTG7-10L, FTG7-10L+R, FTG7-10R, FTG7-10VL, FTG7-10VL+R...(Other models you can see in the webshop) |                 |                     |
| <b>accessories for</b>  | 210022  |                 |                     |
|  | <b>GEV No.</b>  | 210021          | <b>Ref. No.</b>     |
|   |   |                 | 12020194<br>U452804 |
|   | cover L 177mm W 52mm H 16mm for control panel mounting pos. right suitable for 700 series   |                 |                     |



1

|   |   |                 |                     |
|---|---|-----------------|---------------------|
| <b>GEV No.</b>  | 210021  | <b>Ref. No.</b> | 12020194<br>U452804 |
| <b>description</b>  | cover L 177mm W 52mm H 16mm for control panel mounting pos. right suitable for 700 series   |                 |                     |
| <b>For models:</b>  | BG7-05, BG7-05I, BG7-10, BG7-10I, BME7-05, BME7-10, BMG7-10, CE7-20, CE7-40, CE7-41, CG7-10, CG7-11, CG7-20, CG-7200, CG7-40, CG-7400, CG7-41, CG-7415, CG7-61, CG-7615, CGB7-61, CGE7-41, CGE7-62, CPG7-05, EN7-05, EN7-10, FE-710, FE-720, FG-710, FG-720, FTE7-05, FTE7-05L, FTE7-05R, FTE7-10, FTE7-10L, FTE7-10L+R, FTE7-10R, FTEC7-05L, FTEC7-10L, FTG7-05, FTG7-05L, FTG7-05R, FTG7-05VL, FTG7-05VR, FTG7-10, FTG7-10L, FTG7-10L+R, FTG7-10R, FTG7-10VL, FTG7-10VL+R...(Other models you can see in the webshop) |                 |                     |
| <b>accessories for</b>  | 210021  |                 |                     |
|  | <b>GEV No.</b>  | 210022          | <b>Ref. No.</b>     |
|   |   |                 | 12020193<br>U452805 |
|   | cover L 177mm W 52mm H 16mm for control panel mounting pos. left suitable for 700 series  |                 |                     |



1

|                    |                           |                 |                     |
|--------------------|---------------------------|-----------------|---------------------|
| <b>GEV No.</b>     | 550769                    | <b>Ref. No.</b> | 12015009<br>U805616 |
| <b>description</b> | cover plate for switch    |                 |                     |
| <b>For models:</b> | CE7-41, CGE7-215, CGE7-41 |                 |                     |

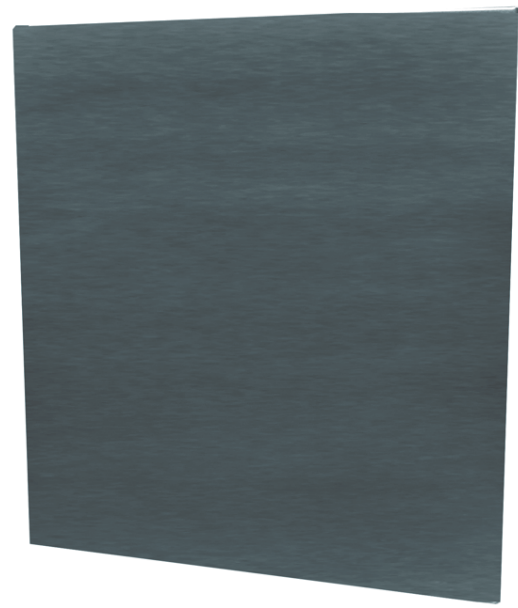

1

|                    |   |                 |          |
|--------------------|---|-----------------|----------|
| <b>GEV No.</b>     | 691851  | <b>Ref. No.</b> | 12011376 |
| <b>description</b> | cover plate L 697mm W 623mm plate thickness max. 20mm |                 |          |



1

|                    |  |                 |                     |
|--------------------|--|-----------------|---------------------|
| <b>GEV No.</b>     | 700809   | <b>Ref. No.</b> | 12007564<br>R205409 |
| <b>description</b> | fastening angle L 120mm W 67mm H 28mm  |                 |                     |
| <b>For models:</b> | BG9-05, BG9-10, BME9-05, BME9-10, BMG9-05, BMG9-10, CE9-20, CE9-40, CE9-41, CG9-10, CG9-11, CG9-20, CG9-40, CG9-41, CG9-60, CG9-61, CG9-82, EN9-05, EN9-10, FE-920, FG-920, FG-940, FTE9-05L, FTE9-05R, FTE9-10L, FTE9-10L+R, FTE9-10R, FTEC9-05, FTEC9-05L, FTEC9-05R, FTEC9-10, FTEC9-10L, FTEC9-10L+R, FTEC9-10R, FTG9-05L, FTG9-05R, FTG9-05VL, FTG9-05VR, FTG9-10L, FTG9-10L+R, FTG9-10R, FTG9-10VL, FTG9-10VL+R, FTG9-10VR, FTGC9-05, FTGC9-05L, FTGC9-05R, FTGC9-10, FTGC9-10L, FTGC9-10L+R...(Other models you can see in the webshop) |                 |                     |

Зип Общепит

vsezip.ru

+7(812)987-08-81



1

|                    |             |                 |                     |
|--------------------|-------------|-----------------|---------------------|
| <b>GEV No.</b>     | 691724      | <b>Ref. No.</b> | 12014588<br>R942800 |
| <b>description</b> | front panel |                 |                     |
| <b>For models:</b> | EN7-05      |                 |                     |



1

|                    |  |                 |                     |
|--------------------|--|-----------------|---------------------|
| <b>GEV No.</b>     | 691714   | <b>Ref. No.</b> | 12004071<br>H012821 |
| <b>description</b> | front panel for drawers 1/2 W 420mm H 80mm   |                 |                     |
| <b>For models:</b> | BG9-05, BG9-05AD, BG9-05I, BG9-05PF, BG9-05PI, BG9-05PLUS-I, BG9-10, BG9-10AD, BG9-10I, BG9-10PF, BG9-10PI, BG9-10PLUS-I, CG9-10, CG9-20, CG9-40, CG9-60, CGF9-120D, CGF9-120I, FTE9-05L, FTE9-05L-AD, FTE9-05PLUS-CL, FTE9-05PLUS-CR, FTE9-05PLUS-L, FTE9-05PLUS-R, FTE9-05R, FTE9-05R-AD, FTE9-10L, FTE9-10L+R, FTE9-10L+R-AD, FTE9-10L-AD, FTE9-10PLUS-CL, FTE9-10PLUS-LR, FTE9-10PLUS-R, FTE9-10R, FTE9-10R-AD, FTEC9-05L, FTEC9-05L-AD, FTEC9-05R, FTEC9-05R-AD, FTEC9-10L, FTEC9-10L+R, FTEC9-10L+R-AD, FTEC9-10L-AD, FTEC9-10R, FTEC9-10R-AD, FTG9-05L, FTG9-05L-AD...(Other models you can see in the webshop) |                 |                     |



1

|                    |   |                 |                     |
|--------------------|---|-----------------|---------------------|
| <b>GEV No.</b>     | 691719                                    | <b>Ref. No.</b> | 12014273<br>U732805 |
| <b>description</b> | front panel for gas range W 700mm H 170mm |                 |                     |



1

|                    |   |                 |                     |
|--------------------|---|-----------------|---------------------|
| <b>GEV No.</b>     | 691723  | <b>Ref. No.</b> | 12008013<br>U745610 |
| <b>description</b> | insulation  |                 |                     |
| <b>For models:</b> | CG7-11, CG7-41, CG7-61, CG9-11, CG9-41, CG9-51L, CG9-51LC, CG9-51R, CG9-51RC, CG9-61, CG9-82, CGF9-121D, CGF9-121I, FTG9-11L, FTG9-11L+R, FTG9-11R, FTGC9-11L, FTGC9-11L+R, FTGC9-11R, HG9-10, HG9-20 |                 |                     |



1

|                    |   |                 |                     |
|--------------------|---|-----------------|---------------------|
| <b>GEV No.</b>     | 104123  | <b>Ref. No.</b> | 12013999<br>U742640 |
| <b>description</b> | mounting plate for gas range L 690mm W 110mm H 25mm                       |                 |                     |
| <b>For models:</b> | CE7-41, CG7-11, CG7-41, CGE7-41, FE-720, FG-720, MB7-10, MG7-10, MG7-10BM |                 |                     |

Reglado a BUTANO-PROPANO

Reglage BUTANE-PROPANE

Regulated for L.P.G. using

1

|                    |  |                 |                     |
|--------------------|--|-----------------|---------------------|
| <b>GEV No.</b>     | 691735   | <b>Ref. No.</b> | 12008203<br>U136501 |
| <b>description</b> | sticker Regulated for L.P.G. using   |                 |                     |
| <b>For models:</b> | BG7-05, BG7-05I, BG7-10, BG7-10I, BG9-05, BG9-05I, BG9-05PF, BG9-05PI, BG9-10, BG9-10I, BG9-10PF, BG9-10PI, BME9-05, BME9-05V-T, BME9-10, BME9-10V-T, BMG7-10, BMG9-05, BMG9-05V-T, BMG9-10, BMG9-10V-T, CG-1002, CG-1502, CG-2000, CG-2005, CG-210, CG-210G, CG-300S, CG-310, CG-310G, CG7-10, CG7-11, CG-7115, CG7-20, CG-7200, CG7-20H, CG7-30D, CG7-30I, CG7-31D, CG7-31I, CG7-40, CG-7400, CG7-40H, CG7-41, CG-7415, CG7-41H, CG7-50, CG7-51, CG7-61, CG-7615...(Other models you can see in the webshop) |                 |                     |

Reglado a GAS NATURAL

Reglage GAZ NATUREL

Regulated for NATURAL GAS using

1

|                    |   |                 |                     |
|--------------------|---|-----------------|---------------------|
| <b>GEV No.</b>     | 691736  | <b>Ref. No.</b> | 12008202<br>U134402 |
| <b>description</b> | sticker regulated for NATURAL GAS using   |                 |                     |
| <b>For models:</b> | BG7-05, BG7-05I, BG7-10, BG7-10I, BG9-05, BG9-05I, BG9-05PF, BG9-05PI, BG9-10, BG9-10I, BG9-10PF, BG9-10PI, BME9-05, BME9-05V-T, BME9-10, BME9-10V-T, BMG7-10, BMG-9045, BMG9-05, BMG9-05V-T, BMG9-10, BMG9-10V-T, CG-1002, CG-1502, CG-2000, CG-2005, CG-210, CG-210G, CG-300S, CG-310, CG-310G, CG7-10, CG7-11, CG-7115, CG7-20, CG-7200, CG7-20H, CG7-30D, CG7-30I, CG7-31D, CG7-31I, CG7-40, CG-7400, CG7-40H, CG7-41, CG-7415, CG7-41H, CG7-50, CG7-51, CG7-61...(Other models you can see in the webshop) |                 |                     |



Zip Общепит

for pizza ovens

vsezip.ru

+7(812)987-08-81

1



|                    |   |                 |  |
|--------------------|---|-----------------|--|
| <b>GEV No.</b>     | 691691  | <b>Ref. No.</b> | 12009010<br>12009015<br>U022836<br>U262806 |
| <b>description</b> | type plate FAGOR metal  |                 |  |
| <b>For models:</b> | BG6-05I, BG7-05, BG7-05I, BG7-10, BG7-10I, BG9-05, BG9-05AD, BG9-05I, BG9-05PF, BG9-05PI, BG9-05PLUS-I, BG9-10, BG9-10AD, BG9-10I, BG9-10PF, BG9-10PI, BG9-10PLUS-I, BME6-05, BME7-05, BME7-10, BME9-05, BME9-05AD, BME9-05PLUS, BME9-05V-T, BME9-10, BME9-10AD, BME9-10PLUS, BME9-10V-T, BMG7-10, BMG9-05, BMG9-05V-T, BMG9-10, BMG9-10V-T, CE6-20, CE6-40, CE6-41, CE7-20, CE7-40, CE7-41, CE9-20, CE9-20AD, CE9-20PLUS, CE9-40, CE9-40AD, CE9-40PLUS, CE9-41, CE9-41AD, CE9-41PLUS, CG-1002, CG-1502...(Other models you can see in the webshop) |                 |  |

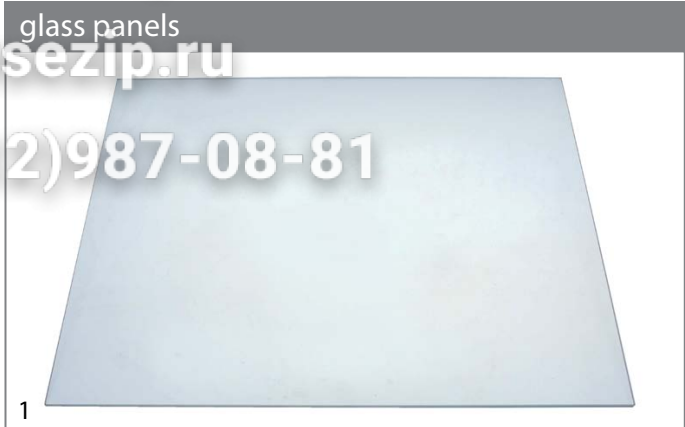

|                    |  |                 |                     |
|--------------------|--|-----------------|---------------------|
| <b>GEV No.</b>     | 700831   | <b>Ref. No.</b> | 12018687<br>R670509 |
| <b>description</b> | glass panel L 460mm H 539mm thickness 5mm rectangular mounting pos. outer  |                 |                     |
| <b>For models:</b> | HCG-10-11, HCG-10-21, HCG-20-11, HCG-2-10-11, HME-10-11, HME-10-21, HME-20-11, HME-2-10-11, HMG-10-11, HMG-10-11UL, HMG-10-21, HMG-10-21UL, HMG-20-11, HMG-2-10-11, HMI-10-11, HMI-10-11UL, HMI-10-21, HMI-10-21UL, HMI-2-10-11, HMM-10-11, HMM-10-11UL, HMM-10-21, HMM-10-21UL, HMM-20-11, HMM-20-11UL, HMM-20-21, HMM-2-10-11, HMP-10-11, HMP-10-21, HMP-20-11, HMP-20-21, HMP-2-10-11 |                 |                     |

doors



|                    |                                     |                 |                        |
|--------------------|-------------------------------------|-----------------|------------------------|
| <b>GEV No.</b>     | 691848                              | <b>Ref. No.</b> | 1100002599<br>12015851 |
| <b>description</b> | door W 690mm H 480mm thickness 40mm |                 |                        |

for dishwashers

drain and intake components

FAGOR

drain /intake bodies



1

|                    |  |                 |                     |
|--------------------|--|-----------------|---------------------|
| <b>GEV No.</b>     | 505162   | <b>Ref. No.</b> | 12025238<br>Z602101 |
| <b>description</b> | drain connection ED ø 45/27mm ID ø 21/18mm   |                 |                     |
| <b>For models:</b> | ECO-1200, ECO-1600, ECO-2300, ECO-2700D, ECO-2700I, ECO-280D, ECO-280I, ECO-3000, ECO-370D, ECO-370I, ECO-4000D, ECO-4000I, ECO-460D, ECO-460I, ECO-550D, ECO-550I, ECO-6000D, ECO-6000I, FI-1200, FI-1600, FI-2300, FI-2700D, FI-2700I, FI-280D, FI-280I, FI-3000, FI-300R, FI-370D, FI-370I, FI-4000D, FI-4000I, FI-460D, FI-460I, FI-550D, FI-550I, FI-6000D, FI-6000I, FI-650R, FI-900 |                 |                     |

Зип Общепит

vsezip.ru

7(812)987-08-81

|   |  |                 |                        |
|---|--|-----------------|------------------------|
|  |  |                 |                        |
| <b>1</b>  |  |                 |                        |
| <b>GEV No.</b>  | 515000   | <b>Ref. No.</b> | 12037642<br>6003010062 |
| <b>description</b>  | drain connection for refrigerated counters thread 1/2" ID ø 14mm L 93.5mm  |                 |                        |
| <b>For models:</b>  | ADM-CN-135, ADM-CN-180, ADM-CN-225, ADMCP-135, ADMCP-180, ADMCP-225, ADMFN-135, ADMFN-180, ADMFN-225, ADMFP-135, ADMFP-135-GR, ADMFP-135HD, ADMFP-135HH, ADMFP-135PC, ADMFP-180, ADMFP-180-GR, ADMFP-180HDD, ADMFP-180HHD, ADMFP-180HHH, ADMFP-180PC, ADMFP-225, ADMFP-225-GR, ADMFP-225HDD, ADMFP-225HHD, ADMFP-225HHH, ADMFP-225HHH, ADMFP-225PC, ATA-061, ATA-061-60Hz, ATA-101, ATA-101-60Hz, ATM-051ECO, ATM-051VCH, ATM-051VCH-60Hz, ATM-081VCH, ATM-081VCH-60Hz, ATM-101VCH, ATM-101VCH-60Hz, ATM-121VCH, ATM-121VCH-60Hz, ATM-121VCHP, ATM-161VCH, MCP-135-AD, MCP-180-AD, MCP-225-AD, MEP-100, MEP-100G, MFP-135-AD, MFP-135-AD-2C, MFP-135-AD-4C...(Other models you can see in the webshop) |                 |                        |

|   |   |                 |                     |
|---|---|-----------------|---------------------|
|  |   |                 |                     |
| <b>2</b>  |   |                 |                     |
| <b>GEV No.</b>  | 505259  | <b>Ref. No.</b> | 12024339<br>Z102104 |
| <b>description</b>  | drain fitting thread 1½" H 42mm   |                 |                     |
| <b>For models:</b>  | ECO-1600, ECO-2300, ECO-2700D, ECO-2700I, ECO-280D, ECO-280I, ECO-3000, ECO-370D, ECO-370I, ECO-4000D, ECO-4000I, ECO-460D, ECO-460I, ECO-550D, ECO-550I, ECO-6000D, ECO-6000I, FI-1600, FI-2300, FI-2700D, FI-2700I, FI-280D, FI-280I, FI-3000, FI-370D, FI-370I, FI-4000D, FI-4000I, FI-460D, FI-460I, FI-550D, FI-550I, FI-6000D, FI-6000I |                 |                     |

|   |   |                 |                     |
|---|---|-----------------|---------------------|
|  |   |                 |                     |
| <b>1</b>  |   |                 |                     |
| <b>GEV No.</b>  | 505193  | <b>Ref. No.</b> | 12024234<br>Z710902 |
| <b>description</b>  | drain fitting thread 1¾" ID ø 44mm  |                 |                     |
| <b>For models:</b>  | AD-120, AD-120B, AD-120BBTDD-UK, AD-120C, AD-120CW, AD-120HY, AD-90, AD-90BA, AD-90BBT, AD-90BDD, AD-90DD, ADE-120, ADE-120B, ECO-120, ECO-120B, ECO-160, ECO-160D, ECO-160I, ECO-200, ECO-200D, ECO-200H, ECO-200HD, ECO-200HI, ECO-200I, ECO-2700D, ECO-2700I, ECO-280D, ECO-280I, ECO-370D, ECO-370I, ECO-4000D, ECO-4000I, ECO-460D, ECO-460I, ECO-550D, ECO-550I, ECO-6000D, ECO-6000I, FI-100, FI-100AR, FI-100B, FI-100BBT-UK, FI-120, FI-120AR+DD, FI-120B, FI-120C, FI-120HY-CLINIC, FI-120W, FI-160, FI-160AR...(Other models you can see in the webshop) |                 |                     |

|   |   |                 |                     |
|---|---|-----------------|---------------------|
|  |   |                 |                     |
| <b>1</b>  |   |                 |                     |
| <b>GEV No.</b>  | 505104  | <b>Ref. No.</b> | 12024603<br>Z220902 |
| <b>description</b>  | drain unit ED ø 32/56mm   |                 |                     |
| <b>For models:</b>  | AD-45BBT, AD-48B, AD-48BDD, AD-48C, AD-48HY, AD-48W, AD-64B, AD-64BBT, AD-64BDD, AD-64C, AD-64CW, AD-64HY, FI-30, FI-30AR, FI-30AR+DD, FI-30B, FI-30B-BT-UK, FI-30-UK, FI-48, FI-48AR, FI-48B, FI-48B-BT-UK, FI-48C, FI-48D, FI-48HY-CLINIC, FI-48W, FI-64, FI-64AR, FI-64B, FI-64B-BT-UK, FI-64C, FI-64D, FI-64HY-CLINIC, FI-64W, MF-48, MF-64 |                 |                     |

|  |  |                 |                     |
|--|--|-----------------|---------------------|
|  |  |                 |                     |
| <b>1</b>   |  |                 |                     |
| <b>GEV No.</b>   | 505085 <sup>1</sup>  | <b>Ref. No.</b> | 12024914<br>Z430901 |
| <b>description</b>   | drain unit hose ø 32/38mm  |                 |                     |
| <b>For models:</b>   | AD-20C-UK, AD-21B, AD-21BDD, AD-21C, AD-21W, LVC-21B, LVC-21C, LVC-21W, LVR-20B, MF-21 |                 |                     |

<sup>1</sup>for drain pump

|  |  |                 |                     |
|--|--|-----------------|---------------------|
|  |  |                 |                     |
| <b>1</b>   |  |                 |                     |
| <b>GEV No.</b>   | 515018   | <b>Ref. No.</b> | 12009947<br>Q307032 |
| <b>description</b>   | flat gasket rubber ED ø 32mm ID ø 21mm thickness 3mm Qty 1 pcs   |                 |                     |
| <b>For models:</b>   | AD-120, AD-120B, AD-120BBTDD-UK, AD-120C, AD-120CW, AD-120HY, AD-90, AD-90BA, AD-90BBT, AD-90BDD, AD-90DD, ADE-120, ADE-120B, BME7-05, BME7-10, BME9-05, BME9-05AD, BME9-05PLUS, BME9-05V-T, BME9-10, BME9-10AD, BME9-10PLUS, BME9-10V-T, BMG7-10, BMG9-05, BMG9-05V-T, BMG9-10, BMG9-10V-T, CO-142W, CO-142WDD, COP-174W, COP-174WHR, ECO-120, ECO-1200, ECO-120B, ECO-160, ECO-1600, ECO-160D, ECO-160I, ECO-200, ECO-200D, ECO-200H, ECO-200HD, ECO-200HI, ECO-200I, ECO-2300, ECO-2700D, ECO-2700I, ECO-280D, ECO-280I...(Other models you can see in the webshop) |                 |                     |

|  |   |                 |                     |
|--|---|-----------------|---------------------|
|  |   |                 |                     |
| <b>1</b>   |   |                 |                     |
| <b>GEV No.</b>   | 505161  | <b>Ref. No.</b> | 12010028<br>Q307027 |
| <b>description</b>   | flat gasket rubber ED ø 45mm ID ø 35mm thickness 2mm Qty 1 pcs  |                 |                     |
| <b>For models:</b>   | BMG-9045, ECO-1200, ECO-1600, ECO-2300, ECO-2700D, ECO-2700I, ECO-280D, ECO-280I, ECO-3000, ECO-370D, ECO-370I, ECO-4000D, ECO-4000I, ECO-460D, ECO-460I, ECO-550D, ECO-550I, ECO-6000D, ECO-6000I, FI-1200, FI-1600, FI-2300, FI-2700D, FI-2700I, FI-280D, FI-280I, FI-3000, FI-300B, FI-300R, FI-370D, FI-370I, FI-4000D, FI-4000I, FI-460D, FI-460I, FI-550D, FI-550I, FI-6000D, FI-6000I, FI-650R, FI-900 |                 |                     |

|  |   |                 |                     |
|--|---|-----------------|---------------------|
|  |   |                 |                     |
| <b>1</b>   |   |                 |                     |
| <b>GEV No.</b>   | 505224  | <b>Ref. No.</b> | 12009960<br>Q307058 |
| <b>description</b>   | flat gasket rubber ED ø 60mm ID ø 44mm thickness 2mm Qty 1 pcs  |                 |                     |
| <b>For models:</b>   | AD-120, AD-120B, AD-120BBTDD-UK, AD-120C, AD-120CW, AD-120HY, AD-90, AD-90BA, AD-90BBT, AD-90BDD, AD-90DD, ADE-120, ADE-120B, ECO-120, ECO-120B, ECO-160, ECO-160D, ECO-160I, ECO-200, ECO-200D, ECO-200H, ECO-200HD, ECO-200HI, ECO-200I, ECO-370D, ECO-370I, ECO-550D, ECO-550I, FI-100, FI-100AR, FI-100B, FI-100BBT-UK, FI-120, FI-120AR+DD, FI-120B, FI-120C, FI-120HY-CLINIC, FI-120W, FI-160, FI-160AR, FI-160D, FI-160I, FI-200, FI-200AR, FI-200D, FI-200H, FI-200HD, FI-200HI, FI-200I, FI-200W...(Other models you can see in the webshop) |                 |                     |





Зип Общепит  
vsezip.ru  
7(812)987-08-81

|   |   |                 |                     |
|---|---|-----------------|---------------------|
|  |   |                 |                     |
| 1   |   |                 |                     |
| <b>GEV No.</b>  | 505223  | <b>Ref. No.</b> | 12009939<br>Q307009 |
| <b>description</b>  | flat gasket rubber ED ø 70mm ID ø 48mm thickness 1.5mm Qty 1 pcs  |                 |                     |
| <b>For models:</b>  | BMG-9045, ECO-1200, ECO-1600, ECO-2300, ECO-2700D, ECO-2700I, ECO-280D, ECO-280I, ECO-3000, ECO-370D, ECO-370I, ECO-4000D, ECO-4000I, ECO-460D, ECO-460I, ECO-550D, ECO-550I, ECO-6000D, ECO-6000I, FI-1200, FI-1600, FI-2300, FI-2700D, FI-2700I, FI-280D, FI-280I, FI-3000, FI-300B, FI-300R, FI-370D, FI-370I, FI-4000D, FI-4000I, FI-460D, FI-460I, FI-550D, FI-550I, FI-6000D, FI-6000I, FI-650R, FI-900 |                 |                     |

|  |   |                 |                     |
|--|---|-----------------|---------------------|
|  |   |                 |                     |
| 1  |   |                 |                     |
| <b>GEV No.</b>   | 505249  | <b>Ref. No.</b> | 12009936<br>Q307011 |
| <b>description</b>   | gasket ED ø 50mm ID ø 39mm thickness 1mm Qty 1 pcs  |                 |                     |
| <b>For models:</b>   | ECO-1600, ECO-2300, ECO-280D, ECO-280I, ECO-3000, ECO-370D, ECO-370I, ECO-460D, ECO-460I, ECO-550D, ECO-550I, FI-1600, FI-2300, FI-280D, FI-280I, FI-3000, FI-370D, FI-370I, FI-460D, FI-460I, FI-550D, FI-550I |                 |                     |

|   |   |                 |                     |
|---|---|-----------------|---------------------|
|  |   |                 |                     |
| 1   |   |                 |                     |
| <b>GEV No.</b>  | 505194  | <b>Ref. No.</b> | 12009937<br>Q307059 |
| <b>description</b>  | flat gasket rubber ED ø 72mm ID ø 57mm thickness 2mm Qty 1 pcs  |                 |                     |
| <b>For models:</b>  | AD-120, AD-120B, AD-120BBTDD-UK, AD-120C, AD-120CW, AD-120HY, AD-90, AD-90BA, AD-90BBT, AD-90BDD, AD-90DD, ADE-120, ADE-120B, ECO-120, ECO-120B, ECO-160, ECO-160D, ECO-160I, ECO-200, ECO-200D, ECO-200H, ECO-200HD, ECO-200HI, ECO-200I, ECO-2700D, ECO-2700I, ECO-280D, ECO-280I, ECO-370D, ECO-370I, ECO-4000D, ECO-4000I, ECO-460D, ECO-460I, ECO-550D, ECO-550I, ECO-6000D, ECO-6000I, FI-100, FI-100AR, FI-100B, FI-100BBT-UK, FI-120, FI-120AR+DD, FI-120B, FI-120C, FI-120HY-CLINIC, FI-120W, FI-160, FI-160AR...(Other models you can see in the webshop) |                 |                     |

|   |  |                 |                     |
|---|--|-----------------|---------------------|
|  |  |                 |                     |
| 1   |  |                 |                     |
| <b>GEV No.</b>  | 518609   | <b>Ref. No.</b> | 12023618<br>Z310901 |
| <b>description</b>  | inlet valve thread 2¼" ED ø 90mm H 131mm   |                 |                     |
| <b>For models:</b>  | ECO-2700D, ECO-2700I, ECO-280D, ECO-280I, ECO-370D, ECO-370I, ECO-4000D, ECO-4000I, ECO-460D, ECO-460I, ECO-550D, ECO-550I, ECO-6000D, ECO-6000I, FI-2700D, FI-2700I, FI-280D, FI-280I, FI-370D, FI-370I, FI-4000D, FI-4000I, FI-460D, FI-460I, FI-550D, FI-550I, FI-6000D, FI-6000I |                 |                     |

|   |  |                 |                     |
|---|--|-----------------|---------------------|
|  |  |                 |                     |
| 1   |  |                 |                     |
| <b>GEV No.</b>  | 510832   | <b>Ref. No.</b> | 12023571<br>Z310902 |
| <b>description</b>  | flat gasket rubber ED ø 92mm ID ø 66mm thickness 2mm Qty 1 pcs equiv. no. 200906/33456   |                 |                     |
| <b>For models:</b>  | ECO-2700D, ECO-2700I, ECO-280D, ECO-280I, ECO-370D, ECO-370I, ECO-4000D, ECO-4000I, ECO-460D, ECO-460I, ECO-550D, ECO-550I, ECO-6000D, ECO-6000I, FI-2700D, FI-2700I, FI-280D, FI-280I, FI-370D, FI-370I, FI-4000D, FI-4000I, FI-460D, FI-460I, FI-550D, FI-550I, FI-6000D, FI-6000I |                 |                     |

|  |  |                 |                        |
|--|--|-----------------|------------------------|
|  |  |                 |                        |
| 1  |  |                 |                        |
| <b>GEV No.</b>   | 519617   | <b>Ref. No.</b> | 12023627<br>Z330787000 |
| <b>description</b>   | intake body ED ø 48mm H 49mm ID ø 30mm   |                 |                        |
| <b>For models:</b>   | ECO-160D, ECO-160I, ECO-200D, ECO-200HD, ECO-200HI, ECO-200I, ECO-280D, ECO-280I, ECO-370D, ECO-370I, ECO-460D, ECO-460I, ECO-550D, ECO-550I, FI-160AR, FI-160D, FI-160I, FI-200AR, FI-200D, FI-200HD, FI-200HI, FI-200I, FI-200WL, FI-200WR, FI-280D, FI-280I, FI-370D, FI-370I, FI-460D, FI-460I, FI-550D, FI-550I |                 |                        |

|   |   |                 |                     |
|---|---|-----------------|---------------------|
|  |   |                 |                     |
| 1   |   |                 |                     |
| <b>GEV No.</b>  | 505222  | <b>Ref. No.</b> | 12009817<br>Q307026 |
| <b>description</b>  | gasket conical ED ø 72mm ID ø 45mm  |                 |                     |
| <b>For models:</b>  | BMG-9045, ECO-1200, ECO-1600, ECO-2300, ECO-2700D, ECO-2700I, ECO-280D, ECO-280I, ECO-3000, ECO-370D, ECO-370I, ECO-4000D, ECO-4000I, ECO-460D, ECO-460I, ECO-550D, ECO-550I, ECO-6000D, ECO-6000I, FI-1200, FI-1600, FI-2300, FI-2700D, FI-2700I, FI-280D, FI-280I, FI-3000, FI-300B, FI-300R, FI-370D, FI-370I, FI-4000D, FI-4000I, FI-460D, FI-460I, FI-550D, FI-550I, FI-6000D, FI-6000I, FI-650R, FI-900 |                 |                     |

|  |   |                 |                     |
|--|---|-----------------|---------------------|
|  |   |                 |                     |
| 1  |   |                 |                     |
| <b>GEV No.</b>   | 524780  | <b>Ref. No.</b> | 12025261<br>Z710903 |
| <b>description</b>   | intake body thread 1½" ED ø 60mm H 42mm hose ø 38mm   |                 |                     |
| <b>For models:</b>   | AD-120, AD-120B, AD-120BBTDD-UK, AD-120C, AD-120CW, AD-120HY, AD-90, AD-90BA, AD-90BBT, AD-90BDD, AD-90DD, ADE-120, ADE-120B, ECO-120, ECO-120B, ECO-160, ECO-160D, ECO-160I, ECO-200, ECO-200D, ECO-200H, ECO-200HD, ECO-200HI, ECO-200I, ECO-370D, ECO-370I, ECO-550D, ECO-550I, FI-100, FI-100AR, FI-100B, FI-100BBT-UK, FI-120, FI-120AR+DD, FI-120B, FI-120C, FI-120HY-CLINIC, FI-120W, FI-160, FI-160AR, FI-160D, FI-160I, FI-200, FI-200AR, FI-200D, FI-200H, FI-200HD, FI-200HI, FI-200I, FI-200W...(Other models you can see in the webshop) |                 |                     |

Зип Общепит



vsezip.ru

+7(812)987 08 81

|   |   |                 |                     |
|---|---|-----------------|---------------------|
|  |   |                 |                     |
| 1   |   |                 |                     |
| <b>GEV No.</b>  | 505160  | <b>Ref. No.</b> | 12025225<br>Z600905 |
| <b>description</b>  | intake body thread 1½" ED ø 71mm ID ø 36mm  |                 |                     |
| <b>For models:</b>  | ECO-1200, ECO-2700D, ECO-2700I, ECO-280D, ECO-280I, ECO-370D, ECO-370I, ECO-4000D, ECO-4000I, ECO-460D, ECO-460I, ECO-550D, ECO-550I, ECO-6000D, ECO-6000I, FI-1200, FI-2700D, FI-2700I, FI-280D, FI-280I, FI-370D, FI-370I, FI-4000D, FI-4000I, FI-460D, FI-460I, FI-550D, FI-550I, FI-6000D, FI-6000I, FI-900 |                 |                     |

|   |   |                 |                     |
|---|---|-----------------|---------------------|
|  |   |                 |                     |
| 1   |   |                 |                     |
| <b>GEV No.</b>  | 505156  | <b>Ref. No.</b> | 12024315<br>Z702101 |
| <b>description</b>  | nut thread 1½"  |                 |                     |
| <b>For models:</b>  | BMG-9045, ECO-1200, ECO-1600, ECO-2300, ECO-2700D, ECO-2700I, ECO-280D, ECO-280I, ECO-3000, ECO-370D, ECO-370I, ECO-4000D, ECO-4000I, ECO-460D, ECO-460I, ECO-550D, ECO-550I, ECO-6000D, ECO-6000I, FI-1200, FI-1600, FI-2300, FI-2700D, FI-2700I, FI-280D, FI-280I, FI-3000, FI-300B, FI-300R, FI-370D, FI-370I, FI-4000D, FI-4000I, FI-460D, FI-460I, FI-550D, FI-550I, FI-6000D, FI-6000I, FI-650R, FI-900 |                 |                     |

|   |   |                 |                     |
|---|---|-----------------|---------------------|
|  |   |                 |                     |
| 1   |   |                 |                     |
| <b>GEV No.</b>  | 505163  | <b>Ref. No.</b> | 12025276<br>Z602102 |
| <b>description</b>  | nut thread 1½"  |                 |                     |
| <b>For models:</b>  | ECO-1200, ECO-1600, ECO-2300, ECO-2700D, ECO-2700I, ECO-280D, ECO-280I, ECO-3000, ECO-370D, ECO-370I, ECO-4000D, ECO-4000I, ECO-460D, ECO-460I, ECO-550D, ECO-550I, ECO-6000D, ECO-6000I, FI-1200, FI-1600, FI-2300, FI-2700D, FI-2700I, FI-280D, FI-280I, FI-3000, FI-300B, FI-300R, FI-370D, FI-370I, FI-4000D, FI-4000I, FI-460D, FI-460I, FI-550D, FI-550I, FI-6000D, FI-6000I, FI-650R, FI-900 |                 |                     |

|   |   |                 |                     |
|---|---|-----------------|---------------------|
|  |   |                 |                     |
| 1   |   |                 |                     |
| <b>GEV No.</b>  | 518080  | <b>Ref. No.</b> | 12023537<br>Z710708 |
| <b>description</b>  | nut thread 1½" WS 50 duct thickness 15mm  |                 |                     |
| <b>For models:</b>  | AD-120, AD-120B, AD-120BBTDD-UK, AD-120C, AD-120CW, AD-120HY, AD-90, AD-90BA, AD-90BBT, AD-90BDD, AD-90DD, ADE-120, ADE-120B, ECO-120, ECO-120B, ECO-160, ECO-160D, ECO-160I, ECO-200, ECO-200D, ECO-200H, ECO-200HD, ECO-200HI, ECO-200I, ECO-370D, ECO-370I, ECO-550D, ECO-550I, FI-100, FI-100AR, FI-100B, FI-100BBT-UK, FI-120, FI-120AR+DD, FI-120B, FI-120C, FI-120HY-CLINIC, FI-120W, FI-160, FI-160AR, FI-160D, FI-160I, FI-200, FI-200AR, FI-200D, FI-200H, FI-200HD, FI-200HI, FI-200I, FI-200W...(Other models you can see in the webshop) |                 |                     |
| <b>spare parts for</b>  | 518080  |                 |                     |
|   | <b>GEV No.</b>  | 507425          | <b>Ref. No.</b>     |
|   |   |                 | 12018740<br>Z710707 |
| duct D1 ø 38mm D2 ø 45mm L 72mm int. ø 1 31mm int. ø 2 39mm                         |   |                 |                     |

|  |   |                 |                     |
|--|---|-----------------|---------------------|
|  |   |                 |                     |
| 1  |   |                 |                     |
| <b>GEV No.</b>   | 505155  | <b>Ref. No.</b> | 12009844<br>Q220001 |
| <b>description</b>   | nut thread 1¾"  |                 |                     |
| <b>For models:</b>   | AD-120, AD-120B, AD-120BBTDD-UK, AD-120C, AD-120CW, AD-120HY, AD-90, AD-90BA, AD-90BBT, AD-90BDD, AD-90DD, ADE-120, ADE-120B, ECO-120, ECO-120B, ECO-160, ECO-160D, ECO-160I, ECO-200, ECO-200D, ECO-200H, ECO-200HD, ECO-200HI, ECO-200I, ECO-2700D, ECO-2700I, ECO-280D, ECO-280I, ECO-370D, ECO-370I, ECO-4000D, ECO-4000I, ECO-460D, ECO-460I, ECO-550D, ECO-550I, ECO-6000D, ECO-6000I, FI-100, FI-100AR, FI-100B, FI-100BBT-UK, FI-120, FI-120AR+DD, FI-120B, FI-120C, FI-120HY-CLINIC, FI-120W, FI-160, FI-160AR...(Other models you can see in the webshop) |                 |                     |

|  |  |                 |                     |
|--|--|-----------------|---------------------|
|  |  |                 |                     |
| 1  |  |                 |                     |
| <b>GEV No.</b>   | 517432   | <b>Ref. No.</b> | 12025231<br>Z310903 |
| <b>description</b>   | nut thread 2¼"   |                 |                     |
| <b>For models:</b>   | ECO-2700D, ECO-2700I, ECO-280D, ECO-280I, ECO-370D, ECO-370I, ECO-4000D, ECO-4000I, ECO-460D, ECO-460I, ECO-550D, ECO-550I, ECO-6000D, ECO-6000I, FI-2700D, FI-2700I, FI-280D, FI-280I, FI-370D, FI-370I, FI-4000D, FI-4000I, FI-460D, FI-460I, FI-550D, FI-550I, FI-6000D, FI-6000I |                 |                     |

|  |   |                 |                     |
|--|---|-----------------|---------------------|
|  |   |                 |                     |
| 1  |   |                 |                     |
| <b>GEV No.</b>   | 505244  | <b>Ref. No.</b> | 12009949<br>Q228006 |
| <b>description</b>   | nut thread M39x3  |                 |                     |
| <b>For models:</b>   | ECO-1600, ECO-2300, ECO-280D, ECO-280I, ECO-3000, ECO-370D, ECO-370I, ECO-460D, ECO-460I, ECO-550D, ECO-550I, FI-1600, FI-2300, FI-280D, FI-280I, FI-3000, FI-370D, FI-370I, FI-460D, FI-460I, FI-550D, FI-550I |                 |                     |

|  |   |                 |                     |
|--|---|-----------------|---------------------|
|  |   |                 |                     |
| 1  |   |                 |                     |
| <b>GEV No.</b>   | 505159  | <b>Ref. No.</b> | 12009815<br>Q228005 |
| <b>description</b>   | nut thread M48x1.5  |                 |                     |
| <b>For models:</b>   | ECO-1200, ECO-2700D, ECO-2700I, ECO-280D, ECO-280I, ECO-370D, ECO-370I, ECO-4000D, ECO-4000I, ECO-460D, ECO-460I, ECO-550D, ECO-550I, ECO-6000D, ECO-6000I, FI-1200, FI-2700D, FI-2700I, FI-280D, FI-280I, FI-370D, FI-370I, FI-4000D, FI-4000I, FI-460D, FI-460I, FI-550D, FI-550I, FI-6000D, FI-6000I, FI-900 |                 |                     |



Зип Общепит  
vsezip.ru  
(812)987-08-81

filters

1



|                    |  |                 |                     |
|--------------------|--|-----------------|---------------------|
| <b>GEV No.</b>     | 505141   | <b>Ref. No.</b> | 12003451<br>Z270803 |
| <b>description</b> | flat filter H 15mm L 315mm W 223mm   |                 |                     |
| <b>For models:</b> | ECO-160, ECO-160D, ECO-160I, ECO-200, ECO-200D, ECO-200H, ECO-200HD, ECO-200HI, ECO-200I, FI-160, FI-160AR, FI-160D, FI-160I, FI-200, FI-200AR, FI-200D, FI-200H, FI-200HD, FI-200HI, FI-200I, FI-200W, FI-200WL, FI-200WR |                 |                     |

1



|                    |  |                 |                                 |
|--------------------|--|-----------------|---------------------------------|
| <b>GEV No.</b>     | 505137   | <b>Ref. No.</b> | 12003450<br>12038499<br>Z270801 |
| <b>description</b> | flat filter H 15mm L 315mm W 225mm   |                 |                                 |
| <b>For models:</b> | ECO-160, ECO-160D, ECO-160I, ECO-200, ECO-200D, ECO-200H, ECO-200HD, ECO-200HI, ECO-200I, FI-160, FI-160AR, FI-160D, FI-160I, FI-200, FI-200AR, FI-200D, FI-200H, FI-200HD, FI-200HI, FI-200I, FI-200W, FI-200WL, FI-200WR |                 |                                 |

1



|                    |  |                 |                                    |
|--------------------|--|-----------------|------------------------------------|
| <b>GEV No.</b>     | 505187   | <b>Ref. No.</b> | 12003519<br>12038373<br>12Z7108010 |
| <b>description</b> | flat filter H 16mm L 630mm W 220mm   |                 |                                    |
| <b>For models:</b> | AD-120, AD-120B, AD-120BBTDD-UK, AD-120C, AD-120CW, AD-120HY, AD-90, AD-90BA, AD-90BBT, AD-90BDD, AD-90DD, ADE-120, ADE-120B, ECO-120, ECO-120B, FI-100, FI-100AR, FI-100B, FI-100BBT-UK, FI-120, FI-120AR+DD, FI-120B, FI-120C, FI-120HY-CLINIC, FI-120W, FI-80, FI-80AR, FI-80BBT-UK, FI-80W, FI-E-100, LABP-1000, LABP-1200, LABP-800, MF-120 |                 |                                    |

1



|                    |  |                 |  |
|--------------------|--|-----------------|--|
| <b>GEV No.</b>     | 505142   | <b>Ref. No.</b> | 12004370<br>12011137<br>12022559<br>12Z2108010 |
| <b>description</b> | flat filter H 8mm L 263mm W 200mm  |                 |  |
| <b>For models:</b> | AD-45BBT, AD-48, AD-48B, AD-48BDD, AD-48C, AD-48D, AD-48DD, AD-48HY, AD-48W, AD-64, AD-64B, AD-64BBT, AD-64BDD, AD-64BTDD, AD-64C, AD-64CW, AD-64D, AD-64DD, AD-64HY, AD-72, AD-72W, EASY-500HP, EASY-500HPWBDD, FI-48, FI-48AR, FI-48B, FI-48B-BT-UK, FI-48C, FI-48D, FI-48HY-CLINIC, FI-48W, FI-50, FI-64, FI-64AR, FI-64B, FI-64B-BT-UK, FI-64C, FI-64D, FI-64HY-CLINIC, FI-64W, FI-72, FI-72AR, FI-72W, MF-48, MF-64 |                 |  |

1



|                    |   |                 |                     |
|--------------------|---|-----------------|---------------------|
| <b>GEV No.</b>     | 505078  | <b>Ref. No.</b> | 12024556<br>Z200907 |
| <b>description</b> | gasket external height 23.5mm for sump ED ø 225mm ID ø 200mm  |                 |                     |
| <b>For models:</b> | AD-45BBT, AD-48, AD-48B, AD-48BDD, AD-48C, AD-48D, AD-48DD, AD-48HY, AD-48W, AD-64, AD-64B, AD-64BBT, AD-64BDD, AD-64BTDD, AD-64C, AD-64CW, AD-64D, AD-64DD, AD-64HY, AD-72, AD-72W, EASY-500, EASY-500B, EASY-500DD, EASY-500HP, FI-30, FI-30AR, FI-30AR+DD, FI-30B, FI-30B-BT-UK, FI-30-UK, FI-48, FI-48AR, FI-48B, FI-48B-BT-UK, FI-48C, FI-48D, FI-48HY-CLINIC, FI-48W, FI-50, FI-60DD, FI-64, FI-64AR, FI-64B, FI-64B-BT-UK, FI-64C, FI-64D, FI-64HY-CLINIC, FI-64W, FI-72...(Other models you can see in the webshop) |                 |                     |

1



|                    |  |                 |                     |
|--------------------|--|-----------------|---------------------|
| <b>GEV No.</b>     | 505077   | <b>Ref. No.</b> | 12024113<br>Z400902 |
| <b>description</b> | gasket external height 23mm for sump   |                 |                     |
| <b>For models:</b> | AD-15, AD-15D, AD-20C-UK, AD-21, AD-21B, AD-21BDD, AD-21C, AD-21D, AD-21DD, AD-21W, CO-350, CO-350-B, CO-350-B-DD, CO-350-COLD, CO-350-COLD-B, CO-350-COLD-B-DD, CO-350-COLD-DD, CO-350-DD, CO-352-COLD, CO-352-COLD-B, CO-352-COLD-B-DD, CO-352-COLD-DD, CO-400, CO-400-B, CO-400-B-DD, CO-400-COLD, CO-400-COLD-B, CO-400-COLD-B-DD, CO-400-COLD-DD, CO-400-DD, CO-400-SOFT, CO-402-COLD, CO-402-COLD-B, CO-402-COLD-B-DD, CO-402-COLD-DD, CO-402W, LVC-12, LVC-15, LVC-15D, LVC-21, LVC-21B, LVC-21C, LVC-21D, LVC-21W, LVR-10, LVR-14, LVR-14D, LVR-20, LVR-20B, LVR-20D...(Other models you can see in the webshop) |                 |                     |

1



|                    |  |                 |                     |
|--------------------|--|-----------------|---------------------|
| <b>GEV No.</b>     | 505274   | <b>Ref. No.</b> | 12025229<br>Z310906 |
| <b>description</b> | intake filter ø 88mm H 82mm  |                 |                     |
| <b>For models:</b> | ECO-2700D, ECO-2700I, ECO-280D, ECO-280I, ECO-370D, ECO-370I, ECO-4000D, ECO-4000I, ECO-460D, ECO-460I, ECO-550D, ECO-550I, ECO-6000D, ECO-6000I, FI-2700D, FI-2700I, FI-280D, FI-280I, FI-370D, FI-370I, FI-4000D, FI-4000I, FI-460D, FI-460I, FI-550D, FI-550I, FI-6000D, FI-6000I |                 |                     |

1





|                    |  |                 |                                 |
|--------------------|--|-----------------|---------------------------------|
| <b>GEV No.</b>     | 505186   | <b>Ref. No.</b> | 12003428<br>12038374<br>Z710804 |
| <b>description</b> | rectangular filter H 73mm L 150mm W 100mm  |                 |                                 |
| <b>For models:</b> | AD-120, AD-120B, AD-120BBTDD-UK, AD-120C, AD-120CW, AD-120HY, AD-90, AD-90BA, AD-90BBT, AD-90BDD, AD-90DD, ADE-120, ADE-120B, ECO-120, ECO-120B, FI-100, FI-100AR, FI-100B, FI-100BBT-UK, FI-120, FI-120AR+DD, FI-120B, FI-120C, FI-120HY-CLINIC, FI-120W, FI-80, FI-80AR, FI-80BBT-UK, FI-80W, FI-E-100, LABP-1000, LABP-1200, LABP-800, MF-120 |                 |                                 |

Зип Общепит

vsezip.ru



+7(812)987-08-81

|   |   |                 |                                 |
|---|---|-----------------|---------------------------------|
|  |   |                 |                                 |
| 1   |   |                 |                                 |
| <b>GEV No.</b>  | 505234  | <b>Ref. No.</b> | 12016636<br>12025219<br>Z400920 |
| <b>description</b>  | round filters ø 143mm H 125mm   |                 |                                 |
| <b>For models:</b>  | AD-15, AD-15D, AD-20C-UK, AD-21, AD-21B, AD-21BDD, AD-21C, AD-21D, AD-21DD, AD-21W, LVC-12, LVC-15, LVC-15D, LVC-21, LVC-21B, LVC-21C, LVC-21D, LVC-21W |                 |                                 |

|   |   |                 |  |
|---|---|-----------------|--|
|    |   |                 |  |
| 1   |   |                 |  |
| <b>GEV No.</b>  | 505098  | <b>Ref. No.</b> | 12024410<br>Z200922                                |
| <b>description</b>  | round filters ø 204mm H 140mm   |                 |  |
| <b>For models:</b>  | AD-45BBT, AD-48, AD-48B, AD-48BDD, AD-48C, AD-48D, AD-48DD, AD-48HY, AD-48W, AD-64, AD-64B, AD-64BBT, AD-64BDD, AD-64BTDD, AD-64C, AD-64CW, AD-64D, AD-64DD, AD-64HY, AD-72, AD-72W, EASY-500, EASY-500B, EASY-500DD, EASY-500HP, FI-30, FI-30AR, FI-30AR+DD, FI-30B, FI-30B-BT-UK, FI-30-UK, FI-48, FI-48AR, FI-48B, FI-48B-BT-UK, FI-48C, FI-48D, FI-48HY-CLINIC, FI-48W, FI-60DD, FI-64, FI-64AR, FI-64B, FI-64B-BT-UK, FI-64C, FI-64D, FI-64HY-CLINIC, FI-64W, FI-72, FI-72AR...(Other models you can see in the webshop) |                 |  |
| <b>accessories for</b>  | 505098  |                 |  |
|  | <b>GEV No.</b>  | 505071          | <b>Ref. No.</b><br>12024323<br>12153291<br>Z200909 |
| overflow pipe L 180mm ø 40mm  |   |                 |  |

|   |   |                 |                     |
|---|---|-----------------|---------------------|
|  |   |                 |                     |
| 1   |   |                 |                     |
| <b>GEV No.</b>  | 505164  | <b>Ref. No.</b> | 12024284<br>Z600906 |
| <b>description</b>  | round filters ø 80mm H 63mm   |                 |                     |
| <b>For models:</b>  | ECO-1200, ECO-2700D, ECO-2700I, ECO-280D, ECO-280I, ECO-370D, ECO-370I, ECO-4000D, ECO-4000I, ECO-460D, ECO-460I, ECO-550D, ECO-550I, ECO-6000D, ECO-6000I, FI-1200, FI-2700D, FI-2700I, FI-280D, FI-280I, FI-370D, FI-370I, FI-4000D, FI-4000I, FI-460D, FI-460I, FI-550D, FI-550I, FI-6000D, FI-6000I, FI-900 |                 |                     |

|   |  |                 |         |
|---|--|-----------------|---------|
|  |  |                 |         |
| 1   |  |                 |         |
| <b>GEV No.</b>  | 505075   | <b>Ref. No.</b> | Z400904 |
| <b>description</b>  | round filters outflow  |                 |         |
| <b>For models:</b>  | LVC-12, LVC-15, LVC-15D, LVC-21, LVC-21B, LVC-21D, LVC-21W, LVR-10, LVR-14, LVR-14D, LVR-20, LVR-20B, LVR-20D, MF-21 |                 |         |

|  |   |                 |  |
|--|---|-----------------|--|
|  |   |                 |  |
| 1  |   |                 |  |
| <b>GEV No.</b>   | 505076  | <b>Ref. No.</b> | Z200901  |
| <b>description</b>   | round filters outflow   |                 |  |
| <b>For models:</b>   | FI-30, FI-48, FI-48B, FI-48W, FI-50, FI-64, FI-64B, FI-64W, FI-72, MF-48, MF-64 |                 |  |
| <b>accessories for</b>   | 505076  |                 |  |
|   | <b>GEV No.</b>  | 505071          | <b>Ref. No.</b><br>12024323<br>12153291<br>Z200909 |
| overflow pipe L 180mm ø 40mm   |   |                 |  |

|  |   |                 |                     |
|--|---|-----------------|---------------------|
|  |   |                 |                     |
| 1  |   |                 |                     |
| <b>GEV No.</b>   | 505012  | <b>Ref. No.</b> | 12023617<br>Z400901 |
| <b>description</b>   | sump for filter ø 158mm H 67mm  |                 |                     |
| <b>For models:</b>   | AD-15, AD-15D, AD-20C-UK, AD-21, AD-21B, AD-21BDD, AD-21C, AD-21D, AD-21DD, AD-21W, LVC-12, LVC-15, LVC-15D, LVC-21, LVC-21B, LVC-21C, LVC-21D, LVC-21W, LVR-10, LVR-14, LVR-14D, LVR-20, LVR-20B, LVR-20D, MF-21 |                 |                     |

|   |  |                 |                     |
|---|--|-----------------|---------------------|
|  |  |                 |                     |
| 1   |  |                 |                     |
| <b>GEV No.</b>  | 505013   | <b>Ref. No.</b> | 12024367<br>Z200906 |
| <b>description</b>  | sump for filter ø 220mm H 67mm   |                 |                     |
| <b>For models:</b>  | AD-45BBT, AD-48, AD-48B, AD-48BDD, AD-48C, AD-48D, AD-48DD, AD-48HY, AD-48W, AD-64, AD-64B, AD-64BBT, AD-64BDD, AD-64BTDD, AD-64C, AD-64CW, AD-64D, AD-64DD, AD-64HY, AD-72, AD-72W, EASY-500, EASY-500B, EASY-500DD, EASY-500HP, EASY-500HPWBDD, FI-30, FI-30AR, FI-30AR+DD, FI-30B, FI-30B-BT-UK, FI-30-UK, FI-48, FI-48AR, FI-48B, FI-48B-BT-UK, FI-48C, FI-48D, FI-48HY-CLINIC, FI-48W, FI-50, FI-60DD, FI-64, FI-64AR, FI-64B, FI-64B-BT-UK, FI-64C, FI-64D, FI-64HY-CLINIC, FI-64W...(Other models you can see in the webshop) |                 |                     |

|  |  |                 |                     |
|--|--|-----------------|---------------------|
| <b>overflow pipes</b>  |  |                 |                     |
|  |  |                 |                     |
| 1  |  |                 |                     |
| <b>GEV No.</b>   | 505073   | <b>Ref. No.</b> | 12010282<br>Q307041 |
| <b>description</b>   | O-ring EPDM thickness 2.62mm ID ø 20.63mm Qty 1 pcs  |                 |                     |
| <b>For models:</b>   | AD-15, AD-15D, AD-20C-UK, AD-21, AD-21B, AD-21BDD, AD-21C, AD-21D, AD-21W, CG-1002, CG-1502, CG-2000, CG-2000-2P, CG-2002, CG-2002P, CG9-11, CG9-11AD, CG9-11PLUS, CG9-31PLUS-D, CG9-31PLUS-I, CG9-41, CG9-41AD, CG9-41AD-H, CG9-41H, CG9-41PLUS, CG9-41PLUS-H, CG9-51L, CG9-51LC, CG9-51R, CG9-51RC, CG9-61, CG9-61AD, CG9-61AD-H, CG9-61H, CG9-61OP, CG9-61PLUS, CG9-61PLUS-H, CG9-82, CG9-82AD, CG9-82PLUS, CGF9-121D, CGF9-121D-AD, CGF9-121I, CGF9-121PLUS-D, CGF9-121PLUS-I, FF-35, FI-5420, FI-7630, FTG9-11L, FTG9-11L+R...(Other models you can see in the webshop) |                 |                     |









Зип Общепит  
vsezip.ru  
7(812)987 08 81

|   |  |                 |                                |
|---|--|-----------------|--------------------------------|
|  |  |                 |                                |
| 1   |  |                 |                                |
| <b>GEV No.</b>  | 532494   | <b>Ref. No.</b> | 12010165<br>Q307051<br>Q307067 |
| <b>description</b>  | O-ring EPDM thickness 2.62mm ID ø 36.14mm Qty 1 pcs  |                 |                                |
| <b>For models:</b>  | AD-120, AD-120B, AD-120BBTDD-UK, AD-120C, AD-120CW, AD-120HY, AD-45BBT, AD-48, AD-48B, AD-48BDD, AD-48C, AD-48D, AD-48DD, AD-48HY, AD-48W, AD-64, AD-64B, AD-64BBT, AD-64BDD, AD-64BTDD, AD-64C, AD-64CW, AD-64D, AD-64DD, AD-64HY, AD-72, AD-72W, AD-90, AD-90BA, AD-90BBT, AD-90BDD, AD-90DD, ADE-120, ADE-120B, EASY-500, EASY-500B, EASY-500DD, EASY-500HP, ECO-120, ECO-120B, ECO-160, ECO-160D, ECO-160I, ECO-200, ECO-200D, ECO-200H, ECO-200HD, ECO-200HI, ECO-200I, ECO-2700D...(Other models you can see in the webshop) |                 |                                |

|   |               |                 |                    |
|---|---------------|-----------------|--------------------|
|  |               |                 |                    |
| 1   |               |                 |                    |
| <b>GEV No.</b>  | 505158        | <b>Ref. No.</b> | 12040035<br>Z62104 |
| <b>description</b>  | overflow pipe |                 |                    |

|   |  |                 |                     |
|---|--|-----------------|---------------------|
|  |  |                 |                     |
| 1   |  |                 |                     |
| <b>GEV No.</b>  | 518608   | <b>Ref. No.</b> | 12023593<br>Z652101 |
| <b>description</b>  | overflow pipe L 150mm ø 42mm   |                 |                     |
| <b>For models:</b>  | ECO-280D, ECO-280I, ECO-370D, ECO-370I, ECO-460D, ECO-460I, ECO-550D, ECO-550I, FI-280D, FI-280I, FI-300R, FI-370D, FI-370I, FI-460D, FI-460I, FI-550D, FI-550I, FI-650R |                 |                     |

|   |   |                 |                     |
|---|---|-----------------|---------------------|
|  |   |                 |                     |
| 1   |   |                 |                     |
| <b>GEV No.</b>  | 691024  | <b>Ref. No.</b> | 12019791<br>R205018 |
| <b>description</b>  | overflow pipe L 165mm ø 20mm                                  |                 |                     |
| <b>For models:</b>  | BME7-05, BME7-10, BME9-05, BME9-10, BMG7-10, BMG9-05, BMG9-10 |                 |                     |

|   |   |                 |                     |
|---|---|-----------------|---------------------|
|  |   |                 |                     |
| 1   |   |                 |                     |
| <b>GEV No.</b>  | 505070  | <b>Ref. No.</b> | 12025249<br>Z400907 |
| <b>description</b>  | overflow pipe L 165mm ø 25mm  |                 |                     |
| <b>For models:</b>  | AD-15, AD-15D, AD-20C-UK, AD-21, AD-21B, AD-21BDD, AD-21C, AD-21D, AD-21DD, AD-21W, LVC-12, LVC-15, LVC-15D, LVC-21, LVC-21B, LVC-21C, LVC-21D, LVC-21W, LVR-10, LVR-14, LVR-14D, LVR-20, LVR-20B, LVR-20D, MF-21 |                 |                     |
| <b>accessories for</b>  | 505070  |                 |                     |
|  | <b>GEV No.</b>  | 505073          | <b>Ref. No.</b>     |
|   |   |                 | 12010282<br>Q307041 |
|   | O-ring EPDM thickness 2.62mm ID ø 20.63mm Qty 1 pcs   |                 |                     |

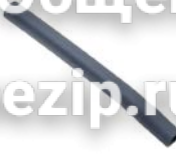
|  |                              |                 |                     |
|--|------------------------------|-----------------|---------------------|
|  |                              |                 |                     |
| 1  |                              |                 |                     |
| <b>GEV No.</b>   | 501237                       | <b>Ref. No.</b> | 12008044<br>H216111 |
| <b>description</b>   | overflow pipe L 172mm ø 16mm |                 |                     |
| <b>For models:</b>   | BME7-05, BME7-10, BMG7-10    |                 |                     |

|   |  |                 |                                 |
|---|--|-----------------|---------------------------------|
|   |  |                 |                                 |
| 1   |  |                 |                                 |
| <b>GEV No.</b>  | 505071   | <b>Ref. No.</b> | 12024323<br>12153291<br>Z200909 |
| <b>description</b>  | overflow pipe L 180mm ø 40mm   |                 |                                 |
| <b>For models:</b>  | AD-45BBT, AD-48, AD-48B, AD-48BDD, AD-48C, AD-48D, AD-48DD, AD-48HY, AD-48W, AD-64, AD-64B, AD-64BBT, AD-64BDD, AD-64C, AD-64CW, AD-64D, AD-64DD, AD-64HY, AD-72, AD-72W, EASY-500, EASY-500DD, EASY-500HP, FI-30, FI-30AR, FI-30AR+DD, FI-30B, FI-30B-BT-UK, FI-30-UK, FI-48, FI-48AR, FI-48B, FI-48B-BT-UK, FI-48C, FI-48D, FI-48HY-CLINIC, FI-48W, FI-50, FI-60DD, FI-64, FI-64AR, FI-64B, FI-64B-BT-UK, FI-64C, FI-64D, FI-64HY-CLINIC, FI-64W, FI-72, FI-72AR, FI-72W...(Other models you can see in the webshop) |                 |                                 |
| <b>accessories for</b>  | 505071   |                 |                                 |
|  | <b>GEV No.</b>   | 505098          | <b>Ref. No.</b>                 |
|   |  |                 | 12024410<br>Z200922             |
|   | round filters ø 204mm H 140mm  |                 |                                 |
|  | <b>GEV No.</b>   | 517004          | <b>Ref. No.</b>                 |
|   |  |                 | —                               |
|   | O-ring EPDM thickness 2.62mm ID ø 34.6mm Qty 1 pcs   |                 |                                 |



|  |   |                 |                     |
|--|---|-----------------|---------------------|
|  |   |                 |                     |
| 1  |   |                 |                     |
| <b>GEV No.</b>   | 512022  | <b>Ref. No.</b> | 12016680<br>Z682101 |
| <b>description</b>   | overflow pipe L 195mm ø 42mm plastic dishwasher |                 |                     |
| <b>For models:</b>   | ECO-1200, FI-1200, FI-900                       |                 |                     |

Зип-Общепит

Containers

vsezip.ru

+7(812)987-08-81

|   |  |                 |                                |
|---|--|-----------------|--------------------------------|
|  |  |                 |                                |
| 1   |  |                 |                                |
| <b>GEV No.</b>  | 505072   | <b>Ref. No.</b> | 12023658<br>Z710901            |
| <b>description</b>  | overflow pipe L 395mm ø 42mm   |                 |                                |
| <b>For models:</b>  | AD-120, AD-120B, AD-120BBTDD-UK, AD-120C, AD-120CW, AD-120HY, AD-90, AD-90BA, AD-90BBT, AD-90BDD, AD-90DD, ADE-120, ADE-120B, ECO-120, ECO-120B, FI-100, FI-100AR, FI-100B, FI-100BBT-UK, FI-120, FI-120AR+DD, FI-120B, FI-120C, FI-120HY-CLINIC, FI-120W, FI-80, FI-80AR, FI-80BBT-UK, FI-80W, FI-E-100, LABP-1000, LABP-1200, LABP-800, MF-120 |                 |                                |
| <b>accessories for</b>  | 505072   |                 |                                |
|  | <b>GEV No.</b>   | 532494          | <b>Ref. No.</b>                |
|   |  |                 | 12010165<br>Q307051<br>Q307061 |
|   | O-ring EPDM thickness 2.62mm ID ø 36.14mm Qty 1 pcs  |                 |                                |

container lids

1

|                    |   |                 |                     |
|--------------------|---|-----------------|---------------------|
| <b>GEV No.</b>     | 510001                                      | <b>Ref. No.</b> | 12018055<br>Z211108 |
| <b>description</b> | lid ø 66mm suitable for rinse aid container |                 |                     |

dosing containers

1

|                    |  |                 |          |
|--------------------|--|-----------------|----------|
| <b>GEV No.</b>     | 505263                                 | <b>Ref. No.</b> | 12021190 |
| <b>description</b> | dosing container L 90mm W 80mm H 105mm |                 |          |

salt tanks

1

|                    |  |                 |                     |
|--------------------|--|-----------------|---------------------|
| <b>GEV No.</b>     | 505229   | <b>Ref. No.</b> | 12023847<br>Z471105 |
| <b>description</b> | filter L 71mm ø 10mm salt tank conical   |                 |                     |
| <b>For models:</b> | AD-15D, AD-21D, AD-48D, AD-64D, FI-48, FI-48AR, FI-48B, FI-48B-BT-UK, FI-48C, FI-48D, FI-48HY-CLINIC, FI-48W, FI-64, FI-64AR, FI-64B, FI-64B-BT-UK, FI-64C, FI-64D, FI-64HY-CLINIC, FI-64W, LVC-15D, LVC-21D |                 |                     |

|   |  |                 |                     |
|---|--|-----------------|---------------------|
|  |  |                 |                     |
| 1   |  |                 |                     |
| <b>GEV No.</b>  | 518607   | <b>Ref. No.</b> | 12024449<br>Z270901 |
| <b>description</b>  | overflow pipe L 480mm ø 44mm   |                 |                     |
| <b>For models:</b>  | ECO-160, ECO-160D, ECO-160I, ECO-200, ECO-200D, ECO-200H, ECO-200HD, ECO-200HI, ECO-200I, FI-160, FI-160AR, FI-160D, FI-160I, FI-200, FI-200AR, FI-200D, FI-200H, FI-200HD, FI-200HI, FI-200I, FI-200W, FI-200WL, FI-200WR |                 |                     |

drive shafts

1

|   |  |                 |                     |
|---|--|-----------------|---------------------|
|  |  |                 |                     |
| <b>GEV No.</b>  | 692327   | <b>Ref. No.</b> | 12024595<br>Z275011 |
| <b>description</b>  | spindle D1 ø 16.5mm warewashing ø 20mm L 165mm D2 ø 20mm FAGOR   |                 |                     |
| <b>For models:</b>  | ECO-160, ECO-160D, ECO-160I, ECO-200, ECO-200D, ECO-200H, ECO-200HD, ECO-200HI, ECO-200I, FI-160, FI-160AR, FI-160D, FI-160I, FI-200, FI-200AR, FI-200D, FI-200H, FI-200HD, FI-200HI, FI-200I, FI-200W, FI-200WL, FI-200WR |                 |                     |



Зип Общепит

vsezip.ru

+7(812)987-08-81

1



|                    |   |                 |                                 |
|--------------------|---|-----------------|---------------------------------|
| <b>GEV No.</b>     | 505220  | <b>Ref. No.</b> | 12025207<br>12047154<br>Z471107 |
| <b>description</b> | flat gasket for salt tank rubber thickness 3.9mm ID ø 68mm ED ø 86mm  |                 |                                 |
| <b>For models:</b> | AD-15D, AD-21D, AD-48D, AD-64D, CO-400-SOFT, FI-48, FI-48AR, FI-48B, FI-48B-BT-UK, FI-48C, FI-48D, FI-48HY-CLINIC, FI-48W, FI-64, FI-64AR, FI-64B, FI-64B-BT-UK, FI-64C, FI-64D, FI-64HY-CLINIC, FI-64W, LVC-15D, LVC-21D |                 |                                 |

2



|   |   |                 |                     |
|---|---|-----------------|---------------------|
| <b>GEV No.</b>  | 524177  | <b>Ref. No.</b> | 12025273<br>Z471108 |
| <b>description</b>  | lid ø 69mm H 20mm for salt tank ID ø 50mm   |                 |                     |
| <b>For models:</b>  | AD-15D, AD-21D, AD-48D, AD-64D, CO-400-SOFT, FI-48, FI-48AR, FI-48B, FI-48B-BT-UK, FI-48C, FI-48D, FI-48HY-CLINIC, FI-48W, FI-64, FI-64AR, FI-64B, FI-64B-BT-UK, FI-64C, FI-64D, FI-64HY-CLINIC, FI-64W, LVC-15D, LVC-21D |                 |                     |
| <b>accessories for</b>  | 524177  |                 |                     |
|   | <b>GEV No.</b>  | <b>Ref. No.</b> | —                   |
|  | 524148  |                 |                     |
|   | O-ring EPDM thickness 3.53mm ID ø 40.86mm Qty 1 pcs   |                 |                     |

1



|                    |   |                 |                     |
|--------------------|---|-----------------|---------------------|
| <b>GEV No.</b>     | 517401  | <b>Ref. No.</b> | 12025272<br>Z471106 |
| <b>description</b> | nut ø 92mm H 10.5mm for salt tank ID ø 64.5mm   |                 |                     |
| <b>For models:</b> | AD-15D, AD-21D, AD-48D, AD-64D, CO-400-SOFT, FI-48, FI-48AR, FI-48B, FI-48B-BT-UK, FI-48C, FI-48D, FI-48HY-CLINIC, FI-48W, FI-64, FI-64AR, FI-64B, FI-64B-BT-UK, FI-64C, FI-64D, FI-64HY-CLINIC, FI-64W, LVC-15D, LVC-21D |                 |                     |

1



|   |  |                 |                                 |
|---|--|-----------------|---------------------------------|
| <b>GEV No.</b>  | 505101   | <b>Ref. No.</b> | 12025142<br>Z471102             |
| <b>description</b>  | salt tank ø 90mm H 86mm  |                 |                                 |
| <b>For models:</b>  | AD-15D, AD-21D, AD-48D, AD-64D, FI-48, FI-48AR, FI-48B, FI-48B-BT-UK, FI-48C, FI-48D, FI-48HY-CLINIC, FI-48W, FI-64, FI-64AR, FI-64B, FI-64B-BT-UK, FI-64C, FI-64D, FI-64HY-CLINIC, FI-64W, LVC-15D, LVC-21D, LVR-14D, LVR-20D |                 |                                 |
| <b>accessories for</b>  | 505101   |                 |                                 |
|   | <b>GEV No.</b>   | <b>Ref. No.</b> | 12025267<br>12047154<br>Z471107 |
|    | 505220   |                 |                                 |
|   | flat gasket for salt tank rubber thickness 3.9mm ID ø 68mm ED ø 86mm   |                 |                                 |
|   | <b>GEV No.</b>   | <b>Ref. No.</b> | 12024031<br>Z471109             |
|    | 506015   |                 |                                 |
|   | O-ring EPDM thickness 3.53mm ID ø 39.69mm Qty 1 pcs  |                 |                                 |
|   | <b>GEV No.</b>   | <b>Ref. No.</b> | 12025272<br>Z471106             |
|   | 517401   |                 |                                 |
|   | nut ø 92mm H 10.5mm for salt tank ID ø 64.5mm  |                 |                                 |
|   | <b>GEV No.</b>   | <b>Ref. No.</b> | 12025273<br>Z471108             |
|  | 524177   |                 |                                 |
|   | lid ø 69mm H 20mm for salt tank ID ø 50mm  |                 |                                 |

boilers

boilers for dishwashers

1



|                    |   |                 |  |
|--------------------|---|-----------------|--|
| <b>GEV No.</b>     | 505209  | <b>Ref. No.</b> | 1200002017<br>12022893<br>12038284<br>Z401701<br>Z401730 |
| <b>description</b> | boiler ø 130mm L 310mm  |                 |  |
| <b>For models:</b> | AD-15, AD-15D, AD-20C-UK, AD-21, AD-21B, AD-21BDD, AD-21C, AD-21D, AD-21DD, AD-21W, LVC-12, LVC-15, LVC-15D, LVC-21, LVC-21B, LVC-21C, LVC-21D, LVC-21W, LVR-10, LVR-14, LVR-14D, LVR-20, LVR-20B, LVR-20D, MF-21 |                 |  |



1

|                    |  |                 |  |
|--------------------|--|-----------------|--|
| <b>GEV No.</b>     | 505210   | <b>Ref. No.</b> | 1200005017<br>12022943<br>12038295<br>Z201701<br>Z201710 |
| <b>description</b> | boiler ø 150mm L 460mm inlet ø 10  |                 |  |
| <b>For models:</b> | AD-120, AD-120B, AD-120C, AD-120CW, AD-48, AD-48B, AD-48BDD, AD-48C, AD-48D, AD-48DD, AD-48W, AD-64, AD-64B, AD-64BDD, AD-64C, AD-64CW, AD-64D, AD-64DD, AD-72, AD-72W, AD-90, AD-90BA, AD-90BDD, AD-90DD, EASY-500, EASY-500B, EASY-500DD, EASY-500HP, FI-100, FI-100AR, FI-100B, FI-120, FI-120AR+DD, FI-120B, FI-120C, FI-120W, FI-30, FI-30AR, FI-30AR+DD, FI-30B, FI-30-UK, FI-48, FI-48AR, FI-48B, FI-48C, FI-48D, FI-48W, FI-50, FI-60DD, FI-64...(Other models you can see in the webshop) |                 |  |



2

|                    |                        |                 |                       |
|--------------------|------------------------|-----------------|-----------------------|
| <b>GEV No.</b>     | 505296                 | <b>Ref. No.</b> | 12038196<br>WX0116204 |
| <b>description</b> | boiler ø 180mm L 410mm |                 |                       |



1

|                    |   |                 |  |
|--------------------|---|-----------------|--|
| <b>GEV No.</b>     | 501342  | <b>Ref. No.</b> | 1200003017<br>12038306<br>Z101701<br>Z316426 |
| <b>description</b> | boiler ø 220mm L 580mm flange flange with thread  |                 |  |
| <b>For models:</b> | ECO-1600, ECO-2300, ECO-3000, FI-1600, FI-2300, FI-2700D, FI-2700I, FI-3000, FI-4000D, FI-4000I, FI-6000D, FI-6000I |                 |  |

## accessories



1

|                    |   |                 |          |
|--------------------|---|-----------------|----------|
| <b>GEV No.</b>     | 518671  | <b>Ref. No.</b> | 12097453 |
| <b>description</b> | hose connector for boiler L 54mm hose ø 10mm  |                 |          |
| <b>For models:</b> | AD-125, AD-125HRS, AD-125-SOFT, AD-505, COP-173, COP-173B, COP-173BDD, COP-173DD, COP-173HRS, COP-173HRSDD, COP-173-SOFT, COP-174, COP-174B, COP-174BDD, COP-174DD, COP-174HRS, COP-174HRSDD, COP-174W, COP-174WHRS, COP-503, COP-503B, COP-503BDD, COP-503DD, COP-503-SOFT, COP-504, COP-504B, COP-504BDD, COP-504DD, COP-504W |                 |          |

## Зип.Общепит

gaskets



1

|                    |   |                 |          |
|--------------------|---|-----------------|----------|
| <b>GEV No.</b>     | 699343  | <b>Ref. No.</b> | 12048366 |
| <b>description</b> | gasket L 118mm W 73mm H 9mm thickness 9mm   |                 |          |
| <b>For models:</b> | AD-125, AD-125HRS, AD-125-SOFT, CO-110, CO-110B, CO-110BDD, CO-110DD, CO-112, CO-112B, CO-112BDD, CO-112DD, CO-170, CO-170B, CO-170BDD, CO-170DD, CO-170HRS, CO-170HRSDD, CO-170HRS-SOFT, CO-170-SOFT, CO-172, CO-172B, CO-172BDD, CO-172DD, COP-173, COP-173B, COP-173BDD, COP-173DD, COP-173HRS, COP-173HRSDD, COP-173-SOFT, COP-174, COP-174B, COP-174BDD, COP-174DD, COP-174HRS, COP-174HRSDD |                 |          |

## rotation plates

## rotation plates



1

|                    |                |                 |  |
|--------------------|----------------|-----------------|--|
| <b>GEV No.</b>     | 505144         | <b>Ref. No.</b> | 12019337<br>12020267<br>Z645901<br>Z645920 |
| <b>description</b> | rotation plate |                 |  |



1

|                    |  |                 |                     |
|--------------------|--|-----------------|---------------------|
| <b>GEV No.</b>     | 505170   | <b>Ref. No.</b> | 12019954<br>Z405901 |
| <b>description</b> | rotation plate ø 290mm plastic seat ø 22mm overall height 54mm |                 |                     |
| <b>For models:</b> | LVR-10, LVR-14, LVR-14D, LVR-20, LVR-20B, LVR-20D              |                 |                     |



Зип Общепит

vsezip.ru

+7(812)987-08-81

rotation plate bearings

|   |                                     |                 |                             |
|---|-------------------------------------|-----------------|-----------------------------|
|  |                                     |                 |                             |
| 1   |                                     |                 |                             |
| <b>GEV No.</b>  | 505015                              | <b>Ref. No.</b> | 12024910 old<br>Z405903 old |
| <b>description</b>  | bearing for rotation plate complete |                 |                             |

|   |                        |                 |                                 |
|---|------------------------|-----------------|---------------------------------|
|  |                        |                 |                                 |
| 1   |                        |                 |                                 |
| <b>GEV No.</b>  | 505165                 | <b>Ref. No.</b> | 12019578<br>12039828<br>Z605911 |
| <b>description</b>  | bearing rotation olate |                 |                                 |

|  |                                 |                 |                     |
|--|---------------------------------|-----------------|---------------------|
|  |                                 |                 |                     |
| 1  |                                 |                 |                     |
| <b>GEV No.</b>   | 505154                          | <b>Ref. No.</b> | 12019027<br>Z645909 |
| <b>description</b>   | bearing rotation olate complete |                 |                     |

softener cartridges

softening columns

|   |   |                 |                     |
|---|---|-----------------|---------------------|
|  |   |                 |                     |
| 1   |   |                 |                     |
| <b>GEV No.</b>  | 505102  | <b>Ref. No.</b> | 12024874<br>Z471101 |
| <b>description</b>  | softener 4-fold L 380mm W 180mm   |                 |                     |
| <b>For models:</b>  | AD-15D, AD-21D, AD-48D, AD-64D, CO-400-SOFT, FI-48, FI-48AR, FI-48B, FI-48B-BT-UK, FI-48C, FI-48D, FI-48HY-CLINIC, FI-48W, FI-64, FI-64AR, FI-64B, FI-64B-BT-UK, FI-64C, FI-64D, FI-64HY-CLINIC, FI-64W, LVC-15D, LVC-21D, LVR-14D, LVR-20D |                 |                     |

|                    |                                 |                 |        |
|--------------------|---------------------------------|-----------------|--------|
| <b>GEV No.</b>     | 530000                          | <b>Ref. No.</b> | 270064 |
| <b>description</b> | softener 4-fold L 380mm W 180mm |                 |        |

spare parts and accessories

|  |  |                 |                     |
|--|--|-----------------|---------------------|
|  |  |                 |                     |
| 1  |  |                 |                     |
| <b>GEV No.</b>   | 691865   | <b>Ref. No.</b> | 12018145<br>Z643013 |
| <b>description</b>   | actuator for door for switch L 102mm ext. ø 11.4 |                 |                     |
| <b>For models:</b>   | FI-300B, FI-300R, FI-650R                        |                 |                     |

|   |   |                 |                     |
|---|---|-----------------|---------------------|
|  |   |                 |                     |
| 1   |   |                 |                     |
| <b>GEV No.</b>  | 691767  | <b>Ref. No.</b> | 12012834<br>R722631 |
| <b>description</b>  | bracket SS L 40mm W 30mm H 50mm   |                 |                     |
| <b>For models:</b>  | FI-30, FI-30AR, FI-30AR+DD, FI-30B, FI-30B-BT-UK, FI-30-UK, FI-48, FI-48AR, FI-48B, FI-48C, FI-48D, FI-48W, FI-50, FI-64, FI-64AR, FI-64B, FI-64C, FI-64D, FI-64W, FI-72, FI-72AR, FI-72W, MF-48, MF-64 |                 |                     |

|   |  |                 |                        |
|---|--|-----------------|------------------------|
|  |  |                 |                        |
| 1   |  |                 |                        |
| <b>GEV No.</b>  | 530905   | <b>Ref. No.</b> | 12024487<br>Z105055000 |
| <b>description</b>  | spacer bush for impulse L 24.5mm ID ø 17.5mm ED ø 20mm suitable for FAGOR  |                 |                        |
| <b>For models:</b>  | ECO-160D, ECO-160I, ECO-200D, ECO-200HD, ECO-200HI, ECO-200I, FI-160AR, FI-160D, FI-160I, FI-200AR, FI-200D, FI-200HD, FI-200HI, FI-200I, FI-200WL, FI-200WR |                 |                        |

## housing and bezels

## fastening angles



1

|                    |  |                 |                     |
|--------------------|--|-----------------|---------------------|
| <b>GEV No.</b>     | 650103   | <b>Ref. No.</b> | 12015774<br>Z400106 |
| <b>description</b> | cross rail L 380mm W 50mm H 10mm mounting distance 355mm |                 |                     |
| <b>For models:</b> | LVC-12, LVC-15, LVC-15D, LVR-10, LVR-14, LVR-14D         |                 |                     |



1

|                    |   |                 |                     |
|--------------------|---|-----------------|---------------------|
| <b>GEV No.</b>     | 505239  | <b>Ref. No.</b> | 12021876<br>Z276354 |
| <b>description</b> | fastening angle L 80mm W 80mm H 38mm  |                 |                     |
| <b>For models:</b> | ECO-120, ECO-120B, ECO-160, ECO-160D, ECO-160I, ECO-200, ECO-200D, ECO-200H, ECO-200HD, ECO-200HI, ECO-200I, ECO-280D, ECO-280I, ECO-370D, ECO-370I, ECO-460D, ECO-460I, ECO-550D, ECO-550I, FI-100, FI-100AR, FI-100B, FI-120, FI-120B, FI-120W, FI-160, FI-160AR, FI-160D, FI-160I, FI-200, FI-200AR, FI-200D, FI-200H, FI-200HD, FI-200HI, FI-200I, FI-200W, FI-200WL, FI-200WR, FI-280D, FI-280I, FI-370D, FI-370I, FI-460D, FI-460I, FI-550D, FI-550I, FI-80, FI-80W, MF-120 |                 |                     |



1

|                    |   |                 |                     |
|--------------------|---|-----------------|---------------------|
| <b>GEV No.</b>     | 505325  | <b>Ref. No.</b> | 12023093<br>Z850111 |
| <b>description</b> | mounting flange for thermostat stainless steel L 48mm W 35mm thickness 1.2mm H 17mm   |                 |                     |
| <b>For models:</b> | ECO-160, ECO-1600, ECO-160D, ECO-160I, ECO-200, ECO-200D, ECO-200H, ECO-200HD, ECO-200HI, ECO-200I, ECO-2300, ECO-2700D, ECO-2700I, ECO-280D, ECO-280I, ECO-3000, ECO-370D, ECO-370I, ECO-4000D, ECO-4000I, ECO-460D, ECO-460I, ECO-550D, ECO-550I, ECO-6000D, ECO-6000I, FI-160, FI-1600, FI-160AR, FI-160D, FI-160I, FI-200, FI-200AR, FI-200D, FI-200H, FI-200HD, FI-200HI, FI-200I, FI-200W, FI-200WL, FI-200WR, FI-2300, FI-2700D, FI-2700I, FI-280D, FI-280I, FI-3000, FI-370D, FI-370I, FI-4000D...(Other models you can see in the webshop) |                 |                     |

## Зип-Общепит

fasela

vsezip.ru

+7(812)987-08-81



|                    |   |                 |                     |
|--------------------|---|-----------------|---------------------|
| <b>GEV No.</b>     | 505337  | <b>Ref. No.</b> | 12025012<br>Z208918 |
| <b>description</b> | front foil for dishwasher FI-48C L 583mm W 62mm |                 |                     |
| <b>For models:</b> | FI-48AR, FI-48C                                 |                 |                     |

## trapdoors



1

|                    |  |                 |                     |
|--------------------|--|-----------------|---------------------|
| <b>GEV No.</b>     | 505241   | <b>Ref. No.</b> | 12014320<br>Z212902 |
| <b>description</b> | door for rinse aid container W 120mm H 110mm thickness 8mm |                 |                     |
| <b>For models:</b> | FI-30, FI-48, FI-48B, FI-50, FI-64, FI-64B, FI-72          |                 |                     |



1

|                    |  |                 |                        |
|--------------------|--|-----------------|------------------------|
| <b>GEV No.</b>     | 505235   | <b>Ref. No.</b> | 1200002020<br>12038297 |
| <b>description</b> | trapdoor for dishwasher W 460mm H 340mm thickness 25mm |                 |                        |
| <b>For models:</b> | AD-21W, LVC-21, LVC-21B, LVC-21C, LVC-21D, LVC-21W     |                 |                        |

Зип Общежит

vsezip.ru

+7(812)987-08-81

hood mechanics for dishwashers

bolts



1

|                    |  |                 |                     |
|--------------------|--|-----------------|---------------------|
| <b>GEV No.</b>     | 505219   | <b>Ref. No.</b> | 12023966<br>Z710542 |
| <b>description</b> | shaft for roller   |                 |                     |
| <b>For models:</b> | AD-120, AD-120B, AD-120BBTDD-UK, AD-120C, AD-120CW, AD-120HY, AD-90, AD-90BA, AD-90BBT, AD-90BDD, AD-90DD, ADE-120, ADE-120B, ECO-120, ECO-120B, FI-100, FI-100AR, FI-100B, FI-100BBT-UK, FI-120, FI-120AR+DD, FI-120B, FI-120C, FI-120HY-CLINIC, FI-120W, FI-80, FI-80AR, FI-80BBT-UK, FI-80W, FI-E-100, LABP-1000, LABP-1200, LABP-800, MF-120 |                 |                     |

bushes



1

|                    |   |                 |                     |
|--------------------|---|-----------------|---------------------|
| <b>GEV No.</b>     | 505272  | <b>Ref. No.</b> | 12025255<br>Z710515 |
| <b>description</b> | bush ED ø 22mm ID ø 10mm L 7mm plastic  |                 |                     |
| <b>For models:</b> | AD-120, AD-120B, AD-120BBTDD-UK, AD-120C, AD-120CW, AD-120HY, AD-125, AD-125HRS, AD-125-SOFT, AD-90, AD-90BA, AD-90BBT, AD-90BDD, AD-90DD, ADE-120, ADE-120B, CO-110, CO-110B, CO-110BDD, CO-110DD, CO-112, CO-112B, CO-112BDD, CO-112DD, CO-142W, CO-142WDD, CO-170, CO-170B, CO-170BDD, CO-170DD, CO-170HRS, CO-170HRSDD, CO-170HRS-SOFT, CO-170-SOFT, CO-172, CO-172B, CO-172BDD, CO-172DD, COP-173, COP-173B, COP-173BDD, COP-173DD, COP-173HRS, COP-173HRSDD, COP-173-SOFT, COP-174, COP-174B, COP-174BDD, COP-174DD, COP-174HRS...(Other models you can see in the webshop) |                 |                     |

spring holders



1

|                    |  |                 |                     |
|--------------------|--|-----------------|---------------------|
| <b>GEV No.</b>     | 505261   | <b>Ref. No.</b> | 12023671<br>Z270512 |
| <b>description</b> | spring holder hood mechanics D1 ø 46mm D2 ø 36mm W 27mm  |                 |                     |
| <b>For models:</b> | ECO-160, ECO-160D, ECO-160I, ECO-200, ECO-200D, ECO-200H, ECO-200HD, ECO-200HI, ECO-200I, ECO-2700D, ECO-2700I, ECO-280D, ECO-280I, ECO-370D, ECO-370I, ECO-4000D, ECO-4000I, ECO-460D, ECO-460I, ECO-550D, ECO-550I, ECO-6000D, ECO-6000I, FI-160, FI-160AR, FI-160D, FI-160I, FI-200, FI-200AR, FI-200D, FI-200H, FI-200HD, FI-200HI, FI-200I, FI-200W, FI-200WL, FI-200WR, FI-2700D, FI-2700I, FI-280D, FI-280I, FI-370D, FI-370I, FI-4000D, FI-4000I, FI-460D, FI-460I, FI-550D, FI-550I, FI-6000D...(Other models you can see in the webshop) |                 |                     |

linkage



1

|                    |   |                 |                     |
|--------------------|---|-----------------|---------------------|
| <b>GEV No.</b>     | 501482  | <b>Ref. No.</b> | 12019124<br>Z680522 |
| <b>description</b> | tie bar L 500mm for hood mechanics for dishwasher |                 |                     |
| <b>For models:</b> | ECO-1200, FI-1200, FI-900                         |                 |                     |

rollers

|                    |  |                 |                     |
|--------------------|--|-----------------|---------------------|
| <b>GEV No.</b>     | 505226   | <b>Ref. No.</b> | 12018644<br>Q308009 |
| <b>description</b> | slide ring PTFE ED ø 19mm ID ø 7.5mm thickness 2mm Qty 1 pcs |                 |                     |
| <b>For models:</b> | FI-300B, FI-300R, FI-650R                                    |                 |                     |



1

|                    |  |                 |                     |
|--------------------|--|-----------------|---------------------|
| <b>GEV No.</b>     | 505225   | <b>Ref. No.</b> | 12009922<br>Q308012 |
| <b>description</b> | slide ring PTFE ED ø 30mm ID ø 10mm thickness 3mm for hood joint Qty 1 pcs   |                 |                     |
| <b>For models:</b> | AD-120, AD-120B, AD-120BBTDD-UK, AD-120C, AD-120CW, AD-120HY, AD-90, AD-90BA, AD-90BBT, AD-90BDD, AD-90DD, ADE-120, ADE-120B, ECO-120, ECO-120B, FI-100, FI-100AR, FI-100B, FI-100BBT-UK, FI-120, FI-120AR+DD, FI-120B, FI-120C, FI-120HY-CLINIC, FI-120W, FI-80, FI-80AR, FI-80BBT-UK, FI-80W, FI-E-100, LABP-1000, LABP-1200, LABP-800, MF-120 |                 |                     |

rollers



1

|                    |  |                 |                     |
|--------------------|--|-----------------|---------------------|
| <b>GEV No.</b>     | 505218   | <b>Ref. No.</b> | 12025210<br>Z710546 |
| <b>description</b> | roller ø 37mm H 12mm plastic hole ø 12.1mm   |                 |                     |
| <b>For models:</b> | AD-120, AD-120B, AD-120BBTDD-UK, AD-120C, AD-120CW, AD-120HY, AD-90, AD-90BA, AD-90BBT, AD-90BDD, AD-90DD, ADE-120, ADE-120B, ECO-120, ECO-120B, FI-100, FI-100AR, FI-100B, FI-100BBT-UK, FI-120, FI-120AR+DD, FI-120B, FI-120C, FI-120HY-CLINIC, FI-120W, FI-80, FI-80AR, FI-80BBT-UK, FI-80W, FI-E-100, LABP-1000, LABP-1200, LABP-800, MF-120 |                 |                     |

miscellaneous



1

|                    |  |                 |                     |
|--------------------|--|-----------------|---------------------|
| <b>GEV No.</b>     | 517431   | <b>Ref. No.</b> | 12011392<br>Z270515 |
| <b>description</b> | bracket for roller spring ømm L 105mm W 44mm H 20mm  |                 |                     |
| <b>For models:</b> | ECO-160, ECO-160D, ECO-160I, ECO-200, ECO-200D, ECO-200H, ECO-200HD, ECO-200HI, ECO-200I, FI-160, FI-160AR, FI-160D, FI-160I, FI-200, FI-200AR, FI-200D, FI-200H, FI-200HD, FI-200HI, FI-200I, FI-200W, FI-200WL, FI-200WR |                 |                     |

Зип Общепит

basket guides

guide bars

vsezip.ru

+7(812)987-08-81



1

|                    |   |                 |                     |
|--------------------|---|-----------------|---------------------|
| <b>GEV No.</b>     | 529240  | <b>Ref. No.</b> | 12010068<br>Q308000 |
| <b>description</b> | flat washer ED ø 16.5mm ID ø 8.2mm plastic thickness 4mm  |                 |                     |
| <b>For models:</b> | AD-120, AD-120B, AD-120BBTDD-UK, AD-120C, AD-120CW, AD-120HY, AD-90, AD-90BA, AD-90BBT, AD-90BDD, AD-90DD, ADE-120, ADE-120B, ECO-120, ECO-1200, ECO-120B, ECO-160, ECO-1600, ECO-160D, ECO-160I, ECO-200, ECO-200D, ECO-200H, ECO-200HD, ECO-200HI, ECO-200I, ECO-2300, ECO-280D, ECO-280I, ECO-3000, ECO-370D, ECO-370I, ECO-460D, ECO-460I, ECO-550D, ECO-550I, FI-100, FI-100AR, FI-100B, FI-100BBT-UK, FI-120, FI-1200, FI-120AR+DD, FI-120B, FI-120C, FI-120HY-CLINIC, FI-120W, FI-160, FI-1600, FI-160D... (Other models you can see in the webshop) |                 |                     |



1

|                    |  |                 |                     |
|--------------------|--|-----------------|---------------------|
| <b>GEV No.</b>     | 529241   | <b>Ref. No.</b> | 12010132<br>Q308002 |
| <b>description</b> | plain washer for dishwashers ED ø 13mm ID ø 6mm plastic thickness 3.5mm  |                 |                     |
| <b>For models:</b> | AD-120, AD-120B, AD-120BBTDD-UK, AD-120C, AD-120CW, AD-120HY, AD-90, AD-90BA, AD-90BBT, AD-90BDD, AD-90DD, ADE-120, ADE-120B, CE-15, CE-9, EASY-500, EASY-500B, EASY-500DD, EASY-500HP, EASY-500HPWBDD, ECO-120, ECO-120B, ECO-160, ECO-1600, ECO-160D, ECO-160I, ECO-200, ECO-200D, ECO-200H, ECO-200HD, ECO-200HI, ECO-200I, ECO-2300, ECO-2700D, ECO-2700I, ECO-280D, ECO-280I, ECO-3000, ECO-370D, ECO-370I, ECO-4000D, ECO-4000I, ECO-460D, ECO-460I, ECO-550D, ECO-550I, ECO-6000D, ECO-6000I, FI-100, FI-100AR... (Other models you can see in the webshop) |                 |                     |



1

|                    |  |                 |                     |
|--------------------|--|-----------------|---------------------|
| <b>GEV No.</b>     | 691890   | <b>Ref. No.</b> | 12023973<br>Z270516 |
| <b>description</b> | rubber pad D1 ø 13mm D2 ø 7mm H 10mm   |                 |                     |
| <b>For models:</b> | ECO-160, ECO-160D, ECO-160I, ECO-200, ECO-200D, ECO-200H, ECO-200HD, ECO-200HI, ECO-200I, ECO-280D, ECO-280I, ECO-370D, ECO-370I, ECO-460D, ECO-460I, ECO-550D, ECO-550I, FI-160, FI-160AR, FI-160D, FI-160I, FI-200, FI-200AR, FI-200D, FI-200H, FI-200HD, FI-200HI, FI-200I, FI-200W, FI-200WL, FI-200WR, FI-280D, FI-280I, FI-370D, FI-370I, FI-460D, FI-460I, FI-550D, FI-550I |                 |                     |



1

|                    |  |                 |                        |
|--------------------|--|-----------------|------------------------|
| <b>GEV No.</b>     | 505329   | <b>Ref. No.</b> | 12038483<br>12Z3150290 |
| <b>description</b> | basket guide L 593mm H 75mm  |                 |                        |
| <b>For models:</b> | ECO-280D, ECO-280I, ECO-370D, ECO-370I, ECO-460D, ECO-460I, ECO-550D, ECO-550I, FI-280D, FI-280I, FI-370D, FI-370I, FI-460D, FI-460I, FI-550D, FI-550I |                 |                        |



1

|                    |   |                 |                        |
|--------------------|---|-----------------|------------------------|
| <b>GEV No.</b>     | 505327  | <b>Ref. No.</b> | 12041428<br>12Z3350250 |
| <b>description</b> | basket guide mounting pos. left bottom L 590mm H 70mm |                 |                        |
| <b>For models:</b> | ECO-370I, ECO-550I, FI-370I, FI-550I                  |                 |                        |



1

|                    |  |                 |                        |
|--------------------|--|-----------------|------------------------|
| <b>GEV No.</b>     | 505328   | <b>Ref. No.</b> | 12038478<br>12Z3350050 |
| <b>description</b> | basket guide mounting pos. right bottom L 590mm H 70mm |                 |                        |
| <b>For models:</b> | ECO-370D, ECO-550D, FI-370D, FI-550D                   |                 |                        |





Зип Общепит



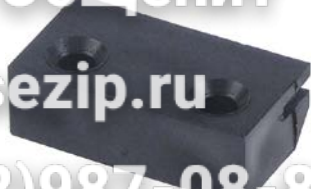

vsezip.ru

+7(812)987-08-81

|  |  |                 |  |
|--|--|-----------------|--|
|  <p>1</p> |  |                 |  |
| <b>GEV No.</b>   | 971056   | <b>Ref. No.</b> | 12014772<br>12021776<br>Z710317<br>Z710326 |
| <b>description</b>   | basket guide mounting pos. upper L 490mm H 36mm hole ø 6mm hole distance 400mm   |                 |  |
| <b>For models:</b>   | AD-120, AD-120B, AD-120BBTDD-UK, AD-120C, AD-120CW, AD-120HY, AD-90, AD-90BA, AD-90BBT, AD-90BDD, AD-90DD, ADE-120, ADE-120B, ECO-120, ECO-120B, FI-100, FI-100AR, FI-100B, FI-100BBT-UK, FI-120, FI-120AR+DD, FI-120B, FI-120C, FI-120HY-CLINIC, FI-120W, FI-80, FI-80AR, FI-80BBT-UK, FI-80W, FI-E-100, LABP-1000, LABP-1200, LABP-800, MF-120 |                 |  |

|  |  |                 |                                |
|--|--|-----------------|--------------------------------|
|  |  |                 |                                |
| <b>GEV No.</b>   | 524591   | <b>Ref. No.</b> | 12024307<br>Z275041<br>Z275075 |
| <b>description</b>   | sliding block for guide bar L 50mm W 27mm H 16mm   |                 |                                |
| <b>For models:</b>   | ECO-160, ECO-160D, ECO-160I, ECO-200, ECO-200D, ECO-200H, ECO-200HD, ECO-200HI, ECO-200I, ECO-280D, ECO-280I, ECO-370D, ECO-370I, ECO-460D, ECO-460I, ECO-550D, ECO-550I, FI-160, FI-160AR, FI-160D, FI-160I, FI-200, FI-200AR, FI-200D, FI-200H, FI-200HD, FI-200HI, FI-200I, FI-200W, FI-200WL, FI-200WR, FI-280D, FI-280I, FI-370D, FI-370I, FI-460D, FI-460I, FI-550D, FI-550I |                 |                                |





|   |  |                 |                     |
|---|--|-----------------|---------------------|
| <p>basket holders</p>  <p>1</p> |  |                 |                     |
| <b>GEV No.</b>  | 504248                                   | <b>Ref. No.</b> | 12023365<br>Z312509 |
| <b>description</b>  | basket support L 435m W 420mm H 90mm 90° |                 |                     |

|   |   |                 |                                |
|---|---|-----------------|--------------------------------|
| <p>air traps</p>  <p>1</p> |   |                 |                                |
| <b>GEV No.</b>  | 505094  | <b>Ref. No.</b> | 12024350<br>Z203011            |
| <b>description</b>  | air trap  |                 |                                |
| <b>For models:</b>  | AD-120, AD-120B, AD-120BBTDD-UK, AD-120C, AD-120CW, AD-120HY, AD-15, AD-15D, AD-20C-UK, AD-21, AD-21B, AD-21BDD, AD-21C, AD-21D, AD-21DD, AD-21W, AD-45BBT, AD-48, AD-48B, AD-48BDD, AD-48C, AD-48D, AD-48DD, AD-48HY, AD-48W, AD-64, AD-64B, AD-64BBT, AD-64BDD, AD-64BTDD, AD-64C, AD-64CW, AD-64D, AD-64DD, AD-64HY, AD-72, AD-72W, AD-90, AD-90BA, AD-90BBT, AD-90BDD, AD-90DD, ADE-120, ADE-120B, EASY-500, EASY-500B, EASY-500DD, EASY-500HP, EASY-500HPWBDD, ECO-120...(Other models you can see in the webshop) |                 |                                |
| <b>accessories for</b>  | 505094  |                 |                                |
|                          |   |                 |                                |
| <b>GEV No.</b>  | 505096  | <b>Ref. No.</b> | 12024157<br>Z201312<br>Z203012 |
| <b>description</b>  | elbow   |                 |                                |
|                          |   |                 |                                |
| <b>GEV No.</b>  | 505184  | <b>Ref. No.</b> | 12024222<br>Z203013            |
| <b>description</b>  | eye bolt  |                 |                                |
|                          |   |                 |                                |
| <b>GEV No.</b>  | 529412  | <b>Ref. No.</b> | 12009873<br>Q307003            |
| <b>description</b>  | O-ring EPDM thickness 2.62mm ID ø 10.78mm Qty 1 pcs   |                 |                                |

|   |   |                 |                     |
|---|---|-----------------|---------------------|
| <p>miscellaneous</p>  <p>1</p> |   |                 |                     |
| <b>GEV No.</b>  | 970861  | <b>Ref. No.</b> | 12024644<br>Z105027 |
| <b>description</b>  | bush for basket transport system mounting pos. rotation plate ext. ø 40 ID ø 33.5mm H 31.5mm brass  |                 |                     |
| <b>For models:</b>  | ECO-160, ECO-160D, ECO-160I, ECO-200, ECO-200D, ECO-200H, ECO-200HD, ECO-200HI, ECO-200I, ECO-2300, ECO-280D, ECO-280I, ECO-3000, ECO-370D, ECO-370I, ECO-460D, ECO-460I, ECO-550D, ECO-550I, FI-160, FI-160D, FI-160AR, FI-160D, FI-160I, FI-200, FI-200AR, FI-200D, FI-200H, FI-200HD, FI-200HI, FI-200I, FI-200W, FI-200WL, FI-200WR, FI-2300, FI-280D, FI-280I, FI-3000, FI-370D, FI-370I, FI-460D, FI-460I, FI-550D, FI-550I |                 |                     |



1

|   |  |                 |                                     |
|---|--|-----------------|-------------------------------------|
| <b>GEV No.</b>  | 510103   | <b>Ref. No.</b> | 12090549<br>12131442                |
| <b>description</b>  | air trap L 85mm W 20mm H 80mm hose ø 6mm plastic   |                 |                                     |
| <b>For models:</b>  | CO-350, CO-350-B, CO-350-B-DD, CO-350-COLD, CO-350-COLD-B, CO-350-COLD-B-DD, CO-350-COLD-DD, CO-350-DD, CO-352-COLD, CO-352-COLD-B, CO-352-COLD-B-DD, CO-352-COLD-DD, CO-400, CO-400-B, CO-400-B-DD, CO-400-COLD, CO-400-COLD-B, CO-400-COLD-B-DD, CO-400-COLD-DD, CO-400-DD, CO-400-SOFT, CO-402-COLD, CO-402-COLD-B, CO-402-COLD-B-DD, CO-402-COLD-DD, CO-402W |                 |                                     |
| <b>spare parts for</b>  | 510103   |                 |                                     |
|  | <b>GEV No.</b>   | 505045          | <b>Ref. No.</b> 12009912<br>Q307036 |
|   | O-ring EPDM thickness 1.78mm ID ø 5.28mm Qty 1 pcs   |                 |                                     |
|  | <b>GEV No.</b>   | 505094          | <b>Ref. No.</b> 12024350<br>Z203011 |
|   | air trap   |                 |                                     |
|  | <b>GEV No.</b>   | 510016          | <b>Ref. No.</b> —                   |
|   | eye bolt for rinse aid container connection  |                 |                                     |
|  | <b>GEV No.</b>   | 510105          | <b>Ref. No.</b> —                   |
|   | hose connector for air trap  |                 |                                     |

## mechanics for flight type dishwashers



1

|                    |                                      |                 |                     |
|--------------------|--------------------------------------|-----------------|---------------------|
| <b>GEV No.</b>     | 505240                               | <b>Ref. No.</b> | 12018670<br>Z331202 |
| <b>description</b> | actuator                             |                 |                     |
| <b>For models:</b> | ECO-370D, ECO-550D, FI-370D, FI-550D |                 |                     |



1

|                    |   |                 |                        |
|--------------------|---|-----------------|------------------------|
| <b>GEV No.</b>     | 505338  | <b>Ref. No.</b> | 12002678<br>1222712130 |
| <b>description</b> | bracket L 70mm W 70mm H 30mm thread M5  |                 |                        |
| <b>For models:</b> | ECO-160, ECO-160D, ECO-160I, ECO-200, ECO-200D, ECO-200H, ECO-200HD, ECO-200HI, ECO-200I, ECO-280D, ECO-280I, ECO-370D, ECO-370I, ECO-460D, ECO-460I, ECO-550D, ECO-550I, FI-160, FI-160AR, FI-160D, FI-160I, FI-200, FI-200AR, FI-200D, FI-200H, FI-200HD, FI-200HI, FI-200I, FI-200WL, FI-200WR, FI-280D, FI-280I, FI-370D, FI-370I, FI-460D, FI-460I, FI-550D, FI-550I |                 |                        |

Зип Общепит

vsezip.ru

+7(812)987-08-81



GEV No.

517326

Ref. No.

12024682  
Z270336  
Z270336000

|                    |   |  |  |
|--------------------|---|--|--|
| <b>description</b> | door guides L 620mm W 37mm H 13mm mounting pos. right   |  |  |
| <b>For models:</b> | ECO-160, ECO-160D, ECO-160I, ECO-200, ECO-200D, ECO-200H, ECO-200HD, ECO-200HI, ECO-200I, ECO-280D, ECO-280I, ECO-370D, ECO-370I, ECO-460D, ECO-460I, ECO-550D, ECO-550I, FI-160, FI-160AR, FI-160D, FI-160I, FI-200, FI-200AR, FI-200D, FI-200H, FI-200HD, FI-200HI, FI-200I, FI-200WL, FI-200WR, FI-280D, FI-280I, FI-370D, FI-370I, FI-460D, FI-460I, FI-550D, FI-550I |  |  |



1

|                    |  |                 |                     |
|--------------------|--|-----------------|---------------------|
| <b>GEV No.</b>     | 519525   | <b>Ref. No.</b> | 12023176<br>Z275021 |
| <b>description</b> | flange for drive shaft ø 44mm ID ø 35mm ED ø 119mm suitable for FAGOR  |                 |                     |
| <b>For models:</b> | ECO-160, ECO-160D, ECO-160I, ECO-200, ECO-200D, ECO-200H, ECO-200HD, ECO-200HI, ECO-200I, FI-160, FI-160AR, FI-160D, FI-160I, FI-200, FI-200AR, FI-200D, FI-200H, FI-200HD, FI-200HI, FI-200I, FI-200W, FI-200WL, FI-200WR |                 |                     |



1

|                    |   |                 |                     |
|--------------------|---|-----------------|---------------------|
| <b>GEV No.</b>     | 697775  | <b>Ref. No.</b> | 12024102<br>Z275007 |
| <b>description</b> | gear wheel DIN/ISO 08 B-1x26T splitting 1/2" teeth 26 shaft intake ø 20mm H 28mm hub ø 43mm   |                 |                     |
| <b>For models:</b> | ECO-160, ECO-160D, ECO-160I, ECO-200HD, ECO-200HI, ECO-280D, ECO-280I, FI-160, FI-160AR, FI-160D, FI-160I, FI-200HD, FI-200HI, FI-200WL, FI-200WR, FI-280D, FI-280I |                 |                     |



1

|                    |  |                 |                                  |
|--------------------|--|-----------------|----------------------------------|
| <b>GEV No.</b>     | 505333   | <b>Ref. No.</b> | 120000140<br>12038281<br>Z335011 |
| <b>description</b> | holder frame for rack conveyor dishwashing machine L 595mm W 480mm H 40mm  |                 |                                  |
| <b>For models:</b> | ECO-370D, ECO-370I, ECO-550D, ECO-550I, FI-370D, FI-370I, FI-550D, FI-550I |                 |                                  |





Зип Общепит

vsezip.ru

+7(812)9870881

|   |  |                 |                     |
|---|--|-----------------|---------------------|
|  |  |                 |                     |
| <b>GEV No.</b>  | 505321   | <b>Ref. No.</b> | 12022145<br>Z271206 |
| <b>description</b>  | magnet holder for transport system $\varnothing$ 35mm hole $\varnothing$ 6mm hole distance 21mm thickness 2mm  |                 |                     |
| <b>For models:</b>  | ECO-160, ECO-160D, ECO-160I, ECO-200, ECO-200D, ECO-200I, ECO-200HD, ECO-200HI, ECO-200I, ECO-280D, ECO-280I, ECO-370D, ECO-370I, ECO-460D, ECO-460I, ECO-550D, ECO-550I, FI-160, FI-160AR, FI-160D, FI-160I, FI-200, FI-200AR, FI-200D, FI-200H, FI-200HD, FI-200HI, FI-200I, FI-200W, FI-200WL, FI-200WR, FI-280D, FI-280I, FI-370D, FI-370I, FI-460D, FI-460I, FI-550D, FI-550I |                 |                     |

|   |  |                 |                        |
|---|--|-----------------|------------------------|
|  |  |                 |                        |
| <b>GEV No.</b>  | 530905   | <b>Ref. No.</b> | 12024487<br>Z105055000 |
| <b>description</b>  | spacer bush for impulse L 24.5mm ID $\varnothing$ 17.5mm ED $\varnothing$ 20mm suitable for FAGOR  |                 |                        |
| <b>For models:</b>  | ECO-160D, ECO-160I, ECO-200D, ECO-200HD, ECO-200HI, ECO-200I, FI-160AR, FI-160D, FI-160I, FI-200AR, FI-200D, FI-200HD, FI-200HI, FI-200I, FI-200WL, FI-200WR |                 |                        |

|   |   |                 |  |
|---|---|-----------------|--|
|  |   |                 |  |
| <b>GEV No.</b>  | 504451  | <b>Ref. No.</b> | 12009828<br>12021015<br>Q362000<br>Z105026 |
| <b>description</b>  | roll pin $\varnothing$ 6.3mm L 50mm SS  |                 |  |
| <b>For models:</b>  | ECO-160, ECO-160D, ECO-160I, ECO-200, ECO-200D, ECO-200H, ECO-200HD, ECO-200HI, ECO-200I, ECO-2300, ECO-280D, ECO-280I, ECO-3000, ECO-370D, ECO-370I, ECO-460D, ECO-460I, ECO-550D, ECO-550I, FI-160, FI-160D, FI-160AR, FI-160D, FI-160I, FI-200, FI-200AR, FI-200D, FI-200H, FI-200HD, FI-200HI, FI-200I, FI-200W, FI-200WL, FI-200WR, FI-2300, FI-280D, FI-280I, FI-3000, FI-370D, FI-370I, FI-460D, FI-460I, FI-550D, FI-550I |                 |  |

|   |  |                 |                     |
|---|--|-----------------|---------------------|
|  |  |                 |                     |
| <b>GEV No.</b>  | 504387   | <b>Ref. No.</b> | 12024391<br>Z271204 |
| <b>description</b>  | spring right for transport system shaft diameter $\varnothing$ 10.5mm L 36mm Wmm Hmm wire gauge $\varnothing$ 1.4mm  |                 |                     |
| <b>For models:</b>  | ECO-160, ECO-160D, ECO-160I, ECO-200, ECO-200D, ECO-200H, ECO-200HD, ECO-200HI, ECO-200I, ECO-280D, ECO-280I, ECO-370D, ECO-370I, ECO-460D, ECO-460I, ECO-550D, ECO-550I, FI-160, FI-160AR, FI-160D, FI-160I, FI-200, FI-200AR, FI-200D, FI-200H, FI-200HD, FI-200HI, FI-200I, FI-200W, FI-200WL, FI-200WR, FI-280D, FI-280I, FI-370D, FI-370I, FI-460D, FI-460I, FI-550D, FI-550I |                 |                     |

|  |   |                 |                                    |
|--|---|-----------------|------------------------------------|
|  |   |                 |                                    |
| <b>GEV No.</b>   | 505330  | <b>Ref. No.</b> | 12031651<br>12048195<br>INXC401001 |
| <b>description</b>   | roller for rack conveyor dishwashing machine L 500mm $\varnothing$ 40mm plastic shaft $\varnothing$ 10mm shaft L 15mm |                 |                                    |

|  |  |                 |                                |
|--|--|-----------------|--------------------------------|
|  |  |                 |                                |
| <b>GEV No.</b>   | 504450   | <b>Ref. No.</b> | 12024681<br>Z275022<br>Z275025 |
| <b>description</b>   | tension bolt for transport system L 98mm ID $\varnothing$ 45mm ED $\varnothing$ 50/34mm  |                 |                                |
| <b>For models:</b>   | ECO-160, ECO-160D, ECO-160I, ECO-200, ECO-200D, ECO-200H, ECO-200HD, ECO-200HI, ECO-200I, ECO-280D, ECO-280I, ECO-370D, ECO-370I, ECO-460D, ECO-460I, ECO-550D, ECO-550I, FI-160, FI-160AR, FI-160D, FI-160I, FI-200, FI-200AR, FI-200D, FI-200H, FI-200HD, FI-200HI, FI-200I, FI-200W, FI-200WL, FI-200WR, FI-280D, FI-280I, FI-370D, FI-370I, FI-460D, FI-460I, FI-550D, FI-550I |                 |                                |

|   |   |                 |                        |
|---|---|-----------------|------------------------|
|  |   |                 |                        |
| <b>GEV No.</b>  | 505331  | <b>Ref. No.</b> | 12032894<br>6020000446 |
| <b>description</b>  | roller for rack conveyor dishwashing machine L 505mm $\varnothing$ 40mm thread M8 |                 |                        |

|                        |   |                 |  |
|------------------------|---|-----------------|--|
| <b>accessories for</b> | 504450  |                 |  |
|                        |  | <b>GEV No.</b>  | 504451                                     |
|                        |   | <b>Ref. No.</b> | 12009828<br>12021015<br>Q362000<br>Z105026 |
|                        | roll pin $\varnothing$ 6.3mm L 50mm SS  |                 |  |

|   |   |                 |                        |
|---|---|-----------------|------------------------|
|  |   |                 |                        |
| <b>GEV No.</b>  | 505332  | <b>Ref. No.</b> | 12033009<br>6020000447 |
| <b>description</b>  | roller for rack conveyor dishwashing machine short L 100mm $\varnothing$ 40mm |                 |                        |

backflow preventers

backflow preventers

|   |  |                 |                     |
|---|--|-----------------|---------------------|
|  |  |                 |                     |
| <b>GEV No.</b>  | 505091   | <b>Ref. No.</b> | 12018668<br>Z231105 |
| <b>description</b>  | backflow preventer dishwasher  |                 |                     |
| <b>For models:</b>  | ECO-120, ECO-120B, FI-100, FI-100AR, FI-100B, FI-120, FI-120B, FI-120W, FI-30, FI-48, FI-48B, FI-48W, FI-50, FI-64, FI-64B, FI-64W, FI-72, FI-80, FI-80W, LVC-21W, MF-120, MF-21, MF-48, MF-64 |                 |                     |

## Зип.Общелит

door mechanics

springs

vsezip.ru

+7(812)987-08-81



1

|                    |  |                 |                                   |
|--------------------|--|-----------------|-----------------------------------|
| <b>GEV No.</b>     | 505183   | <b>Ref. No.</b> | 12023857<br>1210305189<br>Z718418 |
| <b>description</b> | backflow preventer dishwasher  |                 |                                   |
| <b>For models:</b> | AD-120CW, CO-142W, CO-142WDD, FI-120W, FI-200W, FI-200WL, FI-200WR, FI-48, FI-48B, FI-48W, FI-64, FI-64B, FI-64W, FI-80W, MF-120, MF-48, MF-64 |                 |                                   |



1

|                    |  |                 |                     |
|--------------------|--|-----------------|---------------------|
| <b>GEV No.</b>     | 519451   | <b>Ref. No.</b> | 12024689<br>Z270513 |
| <b>description</b> | roller spring W 40mm ID ø 35mm lug length 50mm   |                 |                     |
| <b>For models:</b> | ECO-160, ECO-160D, ECO-160I, ECO-200, ECO-200D, ECO-200H, ECO-200HD, ECO-200HI, ECO-200I, ECO-2700D, ECO-2700I, ECO-280D, ECO-280I, ECO-370D, ECO-370I, ECO-4000D, ECO-4000I, ECO-460D, ECO-460I, ECO-550D, ECO-550I, ECO-6000D, ECO-6000I, FI-160, FI-160AR, FI-160D, FI-160I, FI-200, FI-200AR, FI-200D, FI-200H, FI-200HD, FI-200HI, FI-200I, FI-200W, FI-200WL, FI-200WR, FI-2700D, FI-2700I, FI-280D, FI-280I, FI-370D, FI-370I, FI-4000D, FI-4000I, FI-460D, FI-460I, FI-550D, FI-550I, FI-6000D...(Other models you can see in the webshop) |                 |                     |



1

|  |   |                 |                     |
|--|---|-----------------|---------------------|
| <b>GEV No.</b>   | 516101  | <b>Ref. No.</b> | 12024568<br>Z231106 |
| <b>description</b>   | backflow preventer dishwasher hose ø 12mm   |                 |                     |
| <b>For models:</b>   | AD-120, AD-120B, AD-120C, AD-20C-UK, AD-21, AD-21B, AD-21BDD, AD-21C, AD-21DD, AD-21W, AD-48, AD-48B, AD-48BDD, AD-48C, AD-48DD, AD-48W, AD-64, AD-64B, AD-64BDD, AD-64C, AD-64CW, AD-64D, AD-64DD, AD-72, AD-72W, AD-90, AD-90BA, AD-90BDD, AD-90DD, CO-110, CO-110B, CO-110BDD, CO-110DD, CO-112, CO-112B, CO-112BDD, CO-112DD, CO-170, CO-170B, CO-170BDD, CO-170DD, CO-170HRS, CO-170HRSDD, CO-170HRS-SOFT, CO-170-SOFT, CO-172, CO-172B, CO-172BDD, CO-172DD, CO-350...(Other models you can see in the webshop) |                 |                     |
| <b>spare parts for</b>   | 516101  |                 |                     |
|  | <b>GEV No.</b>  | 506367          | <b>Ref. No.</b> —   |
| flat gasket rubber ED ø 40mm ID ø 28mm thickness 1.8mm Qty 1 pcs                   |   |                 |                     |

## linkage



1

|                    |   |                 |                     |
|--------------------|---|-----------------|---------------------|
| <b>GEV No.</b>     | 519410  | <b>Ref. No.</b> | 12019100<br>Z200521 |
| <b>description</b> | linkage   |                 |                     |
| <b>For models:</b> | FI-30, FI-30AR, FI-30AR+DD, FI-30B, FI-30B-BT-UK, FI-30-UK, FI-48, FI-48AR, FI-48B, FI-48B-BT-UK, FI-48C, FI-48D, FI-48HY-CLINIC, FI-48W, FI-50, FI-64, FI-64AR, FI-64B, FI-64B-BT-UK, FI-64C, FI-64D, FI-64HY-CLINIC, FI-64W, MF-48, MF-64 |                 |                     |

## miscellaneous



1

|                    |             |                 |         |
|--------------------|-------------|-----------------|---------|
| <b>GEV No.</b>     | 505151      | <b>Ref. No.</b> | Z850603 |
| <b>description</b> | pin plastic |                 |         |



1

|                    |  |                 |            |
|--------------------|--|-----------------|------------|
| <b>GEV No.</b>     | 506160   | <b>Ref. No.</b> | Q231450000 |
| <b>description</b> | plain washer ID ø 8.6mm ED ø 16mm thickness 1.5mm SS Qty 1 pcs |                 |            |

## sliding plates



1

|                    |   |                 |                     |
|--------------------|---|-----------------|---------------------|
| <b>GEV No.</b>     | 505195  | <b>Ref. No.</b> | 12024180<br>Z200310 |
| <b>description</b> | sliding plate sliding plate   |                 |                     |
| <b>For models:</b> | AD-20C-UK, AD-21, AD-21B, AD-21BDD, AD-21C, AD-21D, AD-21DD, AD-21W, AD-45BBT, AD-48, AD-48B, AD-48BDD, AD-48C, AD-48D, AD-48DD, AD-48HY, AD-48W, AD-64, AD-64B, AD-64BBT, AD-64BDD, AD-64BTDD, AD-64C, AD-64CW, AD-64D, AD-64DD, AD-64HY, AD-72, AD-72W, EASY-500, EASY-500B, EASY-500DD, EASY-500HP, EASY-500HPWBDD, FI-30, FI-30AR, FI-30AR+DD, FI-30B, FI-30B-BT-UK, FI-30-UK, FI-48, FI-48AR, FI-48B, FI-48B-BT-UK, FI-48C, FI-48D, FI-48HY-CLINIC, FI-48W, FI-50, FI-60DD...(Other models you can see in the webshop) |                 |                     |

Зип Общепит

vsezip.ru  
GEV

+7(812)947-08-81

hinges



1

|   |  |                 |                     |
|---|--|-----------------|---------------------|
| <b>GEV No.</b>  | 505005   | <b>Ref. No.</b> | 12022324<br>Z400514 |
| <b>description</b>  | door hinge hinge left mounting pos. left   |                 |                     |
| <b>For models:</b>  | AD-15, AD-15D, AD-20C-UK, AD-21, AD-21B, AD-21BDD, AD-21C, AD-21D, AD-21DD, AD-21W, AD-45BBT, AD-48, AD-48B, AD-48BDD, AD-48C, AD-48D, AD-48DD, AD-48HY, AD-48W, AD-64, AD-64B, AD-64BBT, AD-64BDD, AD-64BTDD, AD-64C, AD-64CW, AD-64D, AD-64DD, AD-64HY, AD-72, AD-72W, EASY-500, EASY-500B, EASY-500DD, EASY-500HP, EASY-500HPWBDD, FI-30, FI-30AR, FI-30AR+DD, FI-30B, FI-30B-BT-UK, FI-30-UK, FI-48, FI-48AR, FI-48B, FI-48B-BT-UK, FI-48C, FI-48D, FI-48HY-CLINIC, FI-48W...(Other models you can see in the webshop) |                 |                     |
| <b>spare parts for</b>  | 505005   |                 |                     |
|  | <b>GEV No.</b>   | 700818          | <b>Ref. No.</b>     |
|   |  |                 | 12024071<br>Z400516 |
|   | hinge bolt L 32mm stainless steel D1 ø 7.8mm D2 ø 12mm   |                 |                     |



1

|                    |  |                 |                     |
|--------------------|--|-----------------|---------------------|
| <b>GEV No.</b>     | 505006   | <b>Ref. No.</b> | 12022325<br>Z400515 |
| <b>description</b> | door hinge hinge right mounting pos. right   |                 |                     |
| <b>For models:</b> | AD-15, AD-15D, AD-20C-UK, AD-21, AD-21B, AD-21BDD, AD-21C, AD-21D, AD-21DD, AD-21W, AD-45BBT, AD-48, AD-48B, AD-48BDD, AD-48C, AD-48D, AD-48DD, AD-48HY, AD-48W, AD-64, AD-64B, AD-64BBT, AD-64BDD, AD-64BTDD, AD-64C, AD-64CW, AD-64D, AD-64DD, AD-64HY, AD-72, AD-72W, EASY-500, EASY-500B, EASY-500DD, EASY-500HP, EASY-500HPWBDD, FI-30, FI-30AR, FI-30AR+DD, FI-30B, FI-30B-BT-UK, FI-30-UK, FI-48, FI-48AR, FI-48B, FI-48B-BT-UK, FI-48C, FI-48D, FI-48HY-CLINIC, FI-48W...(Other models you can see in the webshop) |                 |                     |



1

|                    |  |                 |  |
|--------------------|--|-----------------|--|
| <b>GEV No.</b>     | 501479   | <b>Ref. No.</b> | 12036714<br>12037269<br>6009990017<br>A169090003 |
| <b>description</b> | door hinge L 130mm for fridge FAGOR  |                 |  |
| <b>For models:</b> | AEP-1402, AEP-1403, AEP-1404, AEP-1602, AEP-1603, AEP-1604, AEP-702, AEP-802, AF-1403-C, AF-1403-P, AF-1404-C, AF-1404-P, AF-1603-C, AF-1603-P, AF-1604-C, AF-1604-P, AF-2104-C, AF-2104-P, AF-2105-C, AF-2105-P, AF-2106-C, AF-2106-P, AFN-1402, AFN-1403, AFN-1404, AFN-1603, AFN-1604, AFN-702, AFN-802, AFP-1402, AFP-1403, AFP-1403-C, AFP-1403-FORZ, AFP-1403-P, AFP-1404, AFP-1404-C, AFP-1404-FORZ, AFP-1404-P, AFP-1603, AFP-1603-2, AFP-1604, AFP-2104, AFP-2104-C, AFP-2104-P, AFP-2105, AFP-2105-C, AFP-2105-P, AFP-2106, AFP-2106-C, AFP-2106-P...(Other models you can see in the webshop) |                 |  |



1

|                    |                                     |                 |                        |
|--------------------|-------------------------------------|-----------------|------------------------|
| <b>GEV No.</b>     | 507439                              | <b>Ref. No.</b> | 1200002010<br>12038286 |
| <b>description</b> | door W 423mm H 300mm thickness 40mm |                 |                        |
| <b>For models:</b> | LVC-12, LVC-15, LVC-15D             |                 |                        |



1

|                    |  |                 |                     |
|--------------------|--|-----------------|---------------------|
| <b>GEV No.</b>     | 507443   | <b>Ref. No.</b> | 12015782<br>Z420531 |
| <b>description</b> | door W 455mm H 370mm thickness 35mm FAGOR suitable for LVC / LVR   |                 |                     |
| <b>For models:</b> | LVC-21, LVC-21B, LVC-21D, LVC-21W, LVR-20, LVR-20B, LVR-20D, MF-21 |                 |                     |



1

|                    |  |                 |  |
|--------------------|--|-----------------|--|
| <b>GEV No.</b>     | 507442   | <b>Ref. No.</b> | 1200005030<br>12006603<br>12013502<br>12038302<br>12Z2005410 |
| <b>description</b> | door W 585mm H 430mm thickness 50mm complete FAGOR   |                 |  |
| <b>For models:</b> | FI-30, FI-30AR, FI-30AR+DD, FI-30B, FI-30B-BT-UK, FI-30-UK, FI-48, FI-48AR, FI-48B, FI-48B-BT-UK, FI-48C, FI-48D, FI-48HY-CLINIC, FI-48W, FI-64, FI-64AR, FI-64B, FI-64B-BT-UK, FI-64C, FI-64D, FI-64HY-CLINIC, FI-64W |                 |  |

Зип-Общепит

rod support

vsezip.ru

+7(812)987-08-81

|   |  |                 |                     |
|---|--|-----------------|---------------------|
|  |  |                 |                     |
| 1   |  |                 |                     |
| <b>GEV No.</b>  | 691912   | <b>Ref. No.</b> | 12015781<br>Z420511 |
| <b>description</b>  | inner door W 405mm H 340mm thickness 18mm FAGOR suitable for LVC / LVR |                 |                     |
| <b>For models:</b>  | LVC-21, LVC-21B, LVC-21D, LVC-21W, LVR-20, LVR-20B, LVR-20D, MF-21     |                 |                     |

## door guides

|  |  |                 |                                   |
|--|--|-----------------|-----------------------------------|
|  |  |                 |                                   |
| 1  |  |                 |                                   |
| <b>GEV No.</b>   | 517826   | <b>Ref. No.</b> | 12024682<br>Z270336<br>Z270336000 |
| <b>description</b>   | door guides L 620mm W 37mm H 13mm mounting pos. right  |                 |                                   |
| <b>For models:</b>   | ECO-160, ECO-160D, ECO-160I, ECO-200, ECO-200D, ECO-200H, ECO-200HD, ECO-200HI, ECO-200I, ECO-280D, ECO-280I, ECO-370D, ECO-370I, ECO-460D, ECO-460I, ECO-550D, ECO-550I, FI-160, FI-160AR, FI-160D, FI-160I, FI-200, FI-200AR, FI-200D, FI-200H, FI-200HD, FI-200HI, FI-200I, FI-200W, FI-200WL, FI-200WR, FI-280D, FI-280I, FI-370D, FI-370I, FI-460D, FI-460I, FI-550D, FI-550I |                 |                                   |

## door frames

|   |   |                 |                     |
|---|---|-----------------|---------------------|
|  |   |                 |                     |
| 1   |   |                 |                     |
| <b>GEV No.</b>  | 504239  | <b>Ref. No.</b> | 12024295<br>Z200524 |
| <b>description</b>  | door frame L 360mm W 15mm H 14mm plastic L-shape mounting distance 150mm  |                 |                     |
| <b>For models:</b>  | AD-45BBT, AD-48, AD-48B, AD-48BDD, AD-48C, AD-48D, AD-48DD, AD-48HY, AD-48W, AD-64, AD-64B, AD-64BBT, AD-64BDD, AD-64BTDD, AD-64C, AD-64CW, AD-64D, AD-64DD, AD-64HY, EASY-500, EASY-500B, EASY-500DD, EASY-500HP, EASY-500HPWBDD, FI-30, FI-30AR, FI-30AR+DD, FI-30B, FI-30B-BT-UK, FI-30-UK, FI-48, FI-48AR, FI-48B, FI-48B-BT-UK, FI-48C, FI-48D, FI-48HY-CLINIC, FI-48W, FI-50, FI-60DD, FI-64, FI-64AR, FI-64B, FI-64B-BT-UK, FI-64C, FI-64D, FI-64HY-CLINIC, FI-64W, MF-48, MF-64 |                 |                     |

|  |   |                 |                       |
|--|---|-----------------|-----------------------|
|  |   |                 |                       |
| 1  |   |                 |                       |
| <b>GEV No.</b>   | 505238  | <b>Ref. No.</b> | 12008904<br>623600000 |
| <b>description</b>   | hook L 245mm  |                 |                       |
| <b>For models:</b>   | CG-1002, CG-1502, CG-2002, CG-2002P, CG-210, CG-210G, CG-310, CG-310G |                 |                       |

## door bumpers

|   |   |                 |                     |
|---|---|-----------------|---------------------|
|  |   |                 |                     |
| 1   |   |                 |                     |
| <b>GEV No.</b>  | 505149  | <b>Ref. No.</b> | 12024299<br>Z200522 |
| <b>description</b>  | door bumper door bumper   |                 |                     |
| <b>For models:</b>  | AD-20C-UK, AD-21, AD-21B, AD-21BDD, AD-21C, AD-21D, AD-21DD, AD-21W, AD-45BBT, AD-48, AD-48B, AD-48BDD, AD-48C, AD-48D, AD-48DD, AD-48HY, AD-48W, AD-64, AD-64B, AD-64BBT, AD-64BDD, AD-64BTDD, AD-64C, AD-64CW, AD-64D, AD-64DD, AD-64HY, AD-72, AD-72W, EASY-500, EASY-500B, EASY-500DD, EASY-500HP, EASY-500HPWBDD, FI-30, FI-30AR, FI-30AR+DD, FI-30B, FI-30B-BT-UK, FI-30-UK, FI-48, FI-48AR, FI-48B, FI-48B-BT-UK, FI-48C, FI-48D, FI-48HY-CLINIC, FI-48W, FI-50, FI-60DD...(Other models you can see in the webshop) |                 |                     |

|  |  |                 |                     |
|--|--|-----------------|---------------------|
|  |  |                 |                     |
| 1  |  |                 |                     |
| <b>GEV No.</b>   | 506266   | <b>Ref. No.</b> | 12016638<br>Z105042 |
| <b>description</b>   | door bumper H 28mm L 66mm W 7.5mm mounting pos. door plastic |                 |                     |
| <b>For models:</b>   | ECO-1600, ECO-2300, ECO-3000, FI-1600, FI-2300, FI-3000      |                 |                     |

## locks

|  |  |                 |                     |
|--|--|-----------------|---------------------|
|  |  |                 |                     |
| 1  |  |                 |                     |
| <b>GEV No.</b>   | 505196   | <b>Ref. No.</b> | 12024235<br>Z200601 |
| <b>description</b>   | door catch   |                 |                     |
| <b>For models:</b>   | AD-15, AD-15D, AD-20C-UK, AD-21, AD-21B, AD-21BDD, AD-21C, AD-21D, AD-21DD, AD-21W, AD-45BBT, AD-48, AD-48B, AD-48BDD, AD-48C, AD-48D, AD-48DD, AD-48HY, AD-48W, AD-64, AD-64B, AD-64BBT, AD-64BDD, AD-64BTDD, AD-64C, AD-64CW, AD-64D, AD-64DD, AD-64HY, AD-72, AD-72W, EASY-500, EASY-500B, EASY-500DD, EASY-500HP, EASY-500HPWBDD, ECO-2700D, ECO-2700I, ECO-4000D, ECO-4000I, ECO-6000D, ECO-6000I, FI-2700D, FI-2700I, FI-30, FI-30AR, FI-30AR+DD, FI-30B, FI-30B-BT-UK, FI-30-UK...(Other models you can see in the webshop) |                 |                     |





Зип Общепит

vsezip.ru

+7(812)987-08-81

|  |  |                 |                                    |
|--|--|-----------------|------------------------------------|
|  <p>1</p> |  |                 |                                    |
| <b>GEV No.</b>   | 505007   | <b>Ref. No.</b> | 12003212<br>12003363<br>12Z2006070 |
| <b>description</b>   | door catch door locking catch  |                 |                                    |
| <b>For models:</b>   | AD-15, AD-15D, AD-20C-UK, AD-21, AD-21B, AD-21BDD, AD-21C, AD-21D, AD-21DD, AD-21W, AD-45BBT, AD-48, AD-48B, AD-48BDD, AD-48C, AD-48D, AD-48DD, AD-48HY, AD-48W, AD-64, AD-64B, AD-64BBT, AD-64BDD, AD-64BTDD, AD-64C, AD-64CW, AD-64D, AD-64DD, AD-64HY, AD-72, AD-72W, EASY-500, EASY-500B, EASY-500DD, EASY-500HP, EASY-500HPWBDD, ECO-2700D, ECO-2700I, ECO-4000D, ECO-4000I, ECO-6000D, ECO-6000I, FI-2700D, FI-2700I, FI-30, FI-30AR, FI-30AR+DD, FI-30B, FI-30B-BT-UK, FI-30-UK...(Other models you can see in the webshop) |                 |                                    |

|  |   |                 |                     |
|--|---|-----------------|---------------------|
|  |   |                 |                     |
| <b>GEV No.</b>   | 508396  | <b>Ref. No.</b> | 12021923<br>Z710543 |
| <b>description</b>   | spring rod straight stainless steel L 140mm W 24mm  |                 |                     |
| <b>For models:</b>   | AD-120, AD-120B, AD-120BBTDD-UK, AD-90, AD-90BA, AD-90BBT, AD-90BDD, AD-90DD, ADE-120, ADE-120B, ECO-120, ECO-120B, FI-100, FI-100AR, FI-100B, FI-100BBT-UK, FI-120, FI-120AR+DD, FI-120B, FI-120C, FI-120HY-CLINIC, FI-120W, FI-80, FI-80AR, FI-80BBT-UK, FI-80W, FI-E-100, LABP-1000, LABP-1200, LABP-800, MF-120 |                 |                     |

|  |   |                 |                     |
|--|---|-----------------|---------------------|
| <p>miscellaneous</p>   |   |                 |                     |
|  <p>1</p> |   |                 |                     |
| <b>GEV No.</b>   | 505010  | <b>Ref. No.</b> | 12023624<br>Z710544 |
| <b>description</b>   | screw screw   |                 |                     |
| <b>For models:</b>   | AD-120, AD-120B, AD-120BBTDD-UK, AD-90, AD-90BA, AD-90BBT, AD-90BDD, AD-90DD, ADE-120, ADE-120B, ECO-120, ECO-120B, FI-100, FI-100AR, FI-100B, FI-100BBT-UK, FI-120, FI-120AR+DD, FI-120B, FI-120C, FI-120HY-CLINIC, FI-120W, FI-80, FI-80AR, FI-80BBT-UK, FI-80W, FI-E-100, LABP-1000, LABP-1200, LABP-800, MF-120 |                 |                     |

|   |   |                 |                     |
|---|---|-----------------|---------------------|
| <p>screw connections</p>  |   |                 |                     |
|  <p>1</p> |   |                 |                     |
| <b>GEV No.</b>  | 505163  | <b>Ref. No.</b> | 12025276<br>Z602102 |
| <b>description</b>  | nut thread 1½"  |                 |                     |
| <b>For models:</b>  | ECO-1200, ECO-1600, ECO-2300, ECO-2700D, ECO-2700I, ECO-280D, ECO-280I, ECO-3000, ECO-370D, ECO-370I, ECO-4000D, ECO-4000I, ECO-460D, ECO-460I, ECO-550D, ECO-550I, ECO-6000D, ECO-6000I, FI-1200, FI-1600, FI-2300, FI-2700D, FI-2700I, FI-280D, FI-280I, FI-3000, FI-300B, FI-300R, FI-370D, FI-370I, FI-4000D, FI-4000I, FI-460D, FI-460I, FI-550D, FI-550I, FI-6000D, FI-6000I, FI-650R, FI-900 |                 |                     |

|  |   |                 |                     |
|--|---|-----------------|---------------------|
|  <p>1</p> |   |                 |                     |
| <b>GEV No.</b>   | 505008  | <b>Ref. No.</b> | 12025166<br>Z710529 |
| <b>description</b>   | spring compressor spring compressor   |                 |                     |
| <b>For models:</b>   | AD-120, AD-120B, AD-120BBTDD-UK, AD-90, AD-90BA, AD-90BBT, AD-90BDD, AD-90DD, ADE-120, ADE-120B, ECO-120, ECO-120B, FI-100, FI-100AR, FI-100B, FI-100BBT-UK, FI-120, FI-120AR+DD, FI-120B, FI-120C, FI-120HY-CLINIC, FI-120W, FI-80, FI-80AR, FI-80BBT-UK, FI-80W, FI-E-100, LABP-1000, LABP-1200, LABP-800, MF-120 |                 |                     |

|   |  |                 |                     |
|---|--|-----------------|---------------------|
|  <p>1</p> |  |                 |                     |
| <b>GEV No.</b>  | 504369   | <b>Ref. No.</b> | 12007871<br>Q223023 |
| <b>description</b>  | nut thread 5/8" pipe (22.7mm) H 7.3mm WS 32 brass Qty 1 pcs  |                 |                     |
| <b>For models:</b>  | AD-120, AD-120B, AD-120BBTDD-UK, AD-120C, AD-120CW, AD-120HY, AD-90, AD-90BA, AD-90BBT, AD-90BDD, AD-90DD, ADE-120, ADE-120B, CO-142W, CO-142WDD, COP-174W, COP-174WHR, ECO-120, ECO-1200, ECO-120B, ECO-160, ECO-1600, ECO-160D, ECO-160I, ECO-200, ECO-200D, ECO-200H, ECO-200HD, ECO-200HI, ECO-200I, ECO-2300, ECO-2700D, ECO-2700I, ECO-280D, ECO-280I, ECO-3000, ECO-370D, ECO-370I, ECO-4000D, ECO-4000I, ECO-460D, ECO-460I, ECO-550D, ECO-550I, ECO-6000D, ECO-6000I, FI-100, FI-100AR, FI-100B, FI-100BBT-UK...(Other models you can see in the webshop) |                 |                     |

curtains

curtains



1

|                    |   |                 |                     |
|--------------------|---|-----------------|---------------------|
| <b>GEV No.</b>     | 533002  | <b>Ref. No.</b> | 12039834<br>Z106405 |
| <b>description</b> | curtain W 615mm H 400mm rubber thickness 2.7mm          |                 |                     |
| <b>For models:</b> | ECO-1600, ECO-2300, ECO-3000, FI-1600, FI-2300, FI-3000 |                 |                     |



1

|                    |   |                 |   |
|--------------------|---|-----------------|---|
| <b>GEV No.</b>     | 533015  | <b>Ref. No.</b> | 12003701<br>12006760<br>12012962<br>12Z2764290<br>Z276410 |
| <b>description</b> | curtain W 620mm H 410mm thickness 1.6mm warewashing   |                 |   |
| <b>For models:</b> | ECO-160, ECO-160D, ECO-160I, ECO-200, ECO-200D, ECO-200H, ECO-200HD, ECO-200HI, ECO-200I, ECO-2700D, ECO-2700I, ECO-280D, ECO-280I, ECO-370D, ECO-370I, ECO-4000D, ECO-4000I, ECO-460D, ECO-460I, ECO-550D, ECO-550I, ECO-6000D, ECO-6000I, FI-160, FI-160AR, FI-160D, FI-160I, FI-200, FI-200AR, FI-200D, FI-200H, FI-200HD, FI-200HI, FI-200I, FI-200W, FI-200WL, FI-200WR, FI-2700D, FI-2700I, FI-280D, FI-280I, FI-370D, FI-370I, FI-4000D, FI-4000I, FI-460D, FI-460I, FI-550D, FI-550I, FI-6000D... (Other models you can see in the webshop) |                 |   |



1

|                    |  |                 |   |
|--------------------|--|-----------------|---|
| <b>GEV No.</b>     | 533014   | <b>Ref. No.</b> | 12006850<br>12012916<br>12Z2764190<br>Z276401 |
| <b>description</b> | curtain W 620mm H 500mm thickness 1.4mm warewashing  |                 |   |
| <b>For models:</b> | ECO-160, ECO-160D, ECO-160I, ECO-200, ECO-200D, ECO-200H, ECO-200HD, ECO-200HI, ECO-200I, ECO-2700D, ECO-2700I, ECO-280D, ECO-280I, ECO-370D, ECO-370I, ECO-4000D, ECO-4000I, ECO-460D, ECO-460I, ECO-550D, ECO-550I, ECO-6000D, ECO-6000I, FI-160, FI-160AR, FI-160D, FI-160I, FI-200, FI-200D, FI-200H, FI-200HD, FI-200HI, FI-200I, FI-200W, FI-2700D, FI-2700I, FI-280D, FI-280I, FI-370D, FI-370I, FI-4000D, FI-4000I, FI-460D, FI-460I, FI-550D, FI-550I, FI-6000D, FI-6000I |                 |   |

Зип Общежит

washing and rinsing systems

vsezip.ru

+7(812)987-08-81

|                    |   |                 |                                 |
|--------------------|---|-----------------|---------------------------------|
| <b>GEV No.</b>     | 505040  | <b>Ref. No.</b> | 12023726<br>12110631<br>Z650704 |
| <b>description</b> | bush for wash arm   |                 |                                 |
| <b>For models:</b> | AD-45BBT, AD-48, AD-48B, AD-48BDD, AD-48C, AD-48D, AD-48DD, AD-48HY, AD-48W, AD-505, AD-505-SOFT, AD-64, AD-64B, AD-64BBT, AD-64BDD, AD-64BTDD, AD-64C, AD-64CW, AD-64D, AD-64DD, AD-64HY, AD-72, AD-72W, AD-90, AD-90BA, AD-90BBT, AD-90BDD, AD-90DD, CO-110, CO-110B, CO-110BDD, CO-110DD, CO-112, CO-112B, CO-112BDD, CO-112DD, CO-500, CO-500B, CO-500BDD, CO-500DD, CO-501, CO-501B, CO-501BDD, CO-501DD, CO-501-SOFT, CO-502B, CO-502BDD, CO-502DD, CO-502W, COP-503... (Other models you can see in the webshop) |                 |                                 |

|                    |   |                 |                     |
|--------------------|---|-----------------|---------------------|
| <b>GEV No.</b>     | 505041  | <b>Ref. No.</b> | 12025116<br>Z710712 |
| <b>description</b> | bush for wash arm   |                 |                     |
| <b>For models:</b> | AD-120, AD-120B, AD-120BBTDD-UK, AD-120C, AD-120CW, AD-120HY, AD-125, AD-125HRS, AD-125-SOFT, ADE-120, ADE-120B, CO-142W, CO-142WDD, CO-170, CO-170B, CO-170BDD, CO-170DD, CO-170HRS, CO-170HRSDD, CO-170HRS-SOFT, CO-170-SOFT, CO-172, CO-172B, CO-172BDD, CO-172DD, COP-173, COP-173B, COP-173BDD, COP-173DD, COP-173HRS, COP-173HRSDD, COP-173-SOFT, COP-174, COP-174B, COP-174BDD, COP-174DD, COP-174HRS, COP-174HRSDD, COP-174W, COP-174WHRS, ECO-120, ECO-120B, FI-100, FI-100AR, FI-100B, FI-100BBT-UK, FI-120, FI-120AR+DD, FI-120B, FI-120C... (Other models you can see in the webshop) |                 |                     |

|                        |   |                 |                     |
|------------------------|---|-----------------|---------------------|
| <b>GEV No.</b>         | 507425  | <b>Ref. No.</b> | 12018740<br>Z710707 |
| <b>description</b>     | duct D1 ø 38mm D2 ø 45mm L 72mm int. ø 1 31mm int. ø 2 39mm   |                 |                     |
| <b>For models:</b>     | ECO-120, ECO-120B, ECO-160D, ECO-160I, ECO-200D, ECO-200I, FI-100, FI-100AR, FI-100B, FI-120, FI-120AR+DD, FI-120B, FI-120C, FI-120HY-CLINIC, FI-120W, FI-160D, FI-160I, FI-200D, FI-200I, FI-E-100, MF-120 |                 |                     |
| <b>spare parts for</b> | 507425  |                 |                     |
| <b>GEV No.</b>         | 518080  | <b>Ref. No.</b> | 12023537<br>Z710708 |
| <b>description</b>     | nut thread 1½" WS 50 duct thickness 15mm  |                 |                     |





Зип Общепит  
vsezip.ru  
+7(812)987-08-81



1

|                        |  |                 |                     |
|------------------------|--|-----------------|---------------------|
| <b>GEV No.</b>         | 505260   | <b>Ref. No.</b> | 12024287<br>Z310721 |
| <b>description</b>     | end cap for wash arm ø 32mm L 33mm suitable for FAGOR  |                 |                     |
| <b>For models:</b>     | ECO-2700D, ECO-2700I, ECO-280D, ECO-280I, ECO-370D, ECO-370I, ECO-4000D, ECO-4000I, ECO-460D, ECO-460I, ECO-550D, ECO-550I, ECO-6000D, ECO-6000I, FI-2700D, FI-2700I, FI-280D, FI-280I, FI-370D, FI-370I, FI-4000D, FI-4000I, FI-460D, FI-460I, FI-550D, FI-550I, FI-6000D, FI-6000I |                 |                     |
| <b>accessories for</b> | 505260   |                 |                     |
|                        | <b>GEV No.</b>   | <b>Ref. No.</b> | —                   |
|                        |  |                 |                     |
|                        | O-ring EPDM thickness 2.62mm ID ø 28.25mm Qty 1 pcs  |                 |                     |



1

|                    |   |                 |   |
|--------------------|---|-----------------|---|
| <b>GEV No.</b>     | 505171  | <b>Ref. No.</b> | 12017466<br>12020831<br>12024375<br>Z200705 |
| <b>description</b> | knurled nut thread M14x1 ø 35mm H 5mm SS  |                 |   |
| <b>For models:</b> | AD-45BBT, AD-48, AD-48B, AD-48BDD, AD-48C, AD-48D, AD-48DD, AD-48HY, AD-48W, AD-64, AD-64B, AD-64BDD, AD-64BDD, AD-64BTDD, AD-64C, AD-64CW, AD-64D, AD-64DD, AD-64HY, AD-72, AD-72W, AD-90, AD-90BA, AD-90BBT, AD-90BDD, AD-90DD, EASY-500, EASY-500B, EASY-500DD, EASY-500HP, EASY-500HPWBDD, FI-30, FI-30AR, FI-30AR+DD, FI-30B, FI-30B-BT-UK, FI-30-UK, FI-48, FI-48AR, FI-48B, FI-48B-BT-UK, FI-48C, FI-48D, FI-48HY-CLINIC, FI-48W, FI-50, FI-60DD, FI-64, FI-64AR, FI-64B...(Other models you can see in the webshop) |                 |   |



1

|                    |   |                 |                     |
|--------------------|---|-----------------|---------------------|
| <b>GEV No.</b>     | 505184  | <b>Ref. No.</b> | 12024222<br>Z203013 |
| <b>description</b> | eye bolt  |                 |                     |
| <b>For models:</b> | AD-120, AD-120B, AD-120BBTDD-UK, AD-120C, AD-120CW, AD-120HY, AD-15, AD-15D, AD-20C-UK, AD-21, AD-21B, AD-21BDD, AD-21C, AD-21D, AD-21DD, AD-21W, AD-45BBT, AD-48, AD-48B, AD-48BDD, AD-48C, AD-48D, AD-48DD, AD-48HY, AD-48W, AD-64, AD-64B, AD-64BBT, AD-64BDD, AD-64BTDD, AD-64C, AD-64CW, AD-64D, AD-64DD, AD-64HY, AD-72, AD-72W, AD-90, AD-90BA, AD-90BBT, AD-90BDD, AD-90DD, ADE-120, ADE-120B, EASY-500, EASY-500B, EASY-500DD, EASY-500HP, EASY-500HPWBDD, ECO-120...(Other models you can see in the webshop) |                 |                     |



1

|                    |   |                 |                     |
|--------------------|---|-----------------|---------------------|
| <b>GEV No.</b>     | 505168  | <b>Ref. No.</b> | 12017869<br>Z400708 |
| <b>description</b> | nut   |                 |                     |
| <b>For models:</b> | LVR-10, LVR-14, LVR-14D, LVR-20, LVR-20B, LVR-20D |                 |                     |



1

|                    |  |                 |                     |
|--------------------|--|-----------------|---------------------|
| <b>GEV No.</b>     | 505227   | <b>Ref. No.</b> | 12019816<br>Z270731 |
| <b>description</b> | gasket for wash arm ø 55mm ID ø 39mm thickness 10mm  |                 |                     |
| <b>For models:</b> | ECO-160, ECO-160D, ECO-160I, ECO-200, ECO-200D, ECO-200H, ECO-200HD, ECO-200HI, ECO-200I, FI-160, FI-160D, FI-160I, FI-200, FI-200D, FI-200H, FI-200HD, FI-200HI, FI-200I, FI-200W |                 |                     |



1

|                        |   |                 |                     |
|------------------------|---|-----------------|---------------------|
| <b>GEV No.</b>         | 518080  | <b>Ref. No.</b> | 12023537<br>Z710708 |
| <b>description</b>     | nut thread 1½" WS 50 duct thickness 15mm  |                 |                     |
| <b>For models:</b>     | AD-120, AD-120B, AD-120BBTDD-UK, AD-120C, AD-120CW, AD-120HY, AD-90, AD-90BA, AD-90BBT, AD-90BDD, AD-90DD, ADE-120, ADE-120B, ECO-120, ECO-120B, ECO-160, ECO-160D, ECO-160I, ECO-200, ECO-200D, ECO-200H, ECO-200HD, ECO-200HI, ECO-200I, ECO-370D, ECO-370I, ECO-550D, ECO-550I, FI-100, FI-100AR, FI-100B, FI-100BBT-UK, FI-120, FI-120AR+DD, FI-120B, FI-120C, FI-120HY-CLINIC, FI-120W, FI-160, FI-160AR, FI-160D, FI-160I, FI-200, FI-200AR, FI-200D, FI-200H, FI-200HD, FI-200HI, FI-200I, FI-200W...(Other models you can see in the webshop) |                 |                     |
| <b>spare parts for</b> | 518080  |                 |                     |
|                        | <b>GEV No.</b>  | <b>Ref. No.</b> | 12018740<br>Z710707 |
|                        |   |                 |                     |
|                        | duct D1 ø 38mm D2 ø 45mm L 72mm int. ø 1 31mm int. ø 2 39mm   |                 |                     |



1

|                    |  |                 |                     |
|--------------------|--|-----------------|---------------------|
| <b>GEV No.</b>     | 505173   | <b>Ref. No.</b> | 12023653<br>Z680738 |
| <b>description</b> | knurled nut  |                 |                     |
| <b>For models:</b> | AD-120, AD-120B, AD-120BBTDD-UK, AD-120C, AD-120CW, AD-120HY, ADE-120, ADE-120B, ECO-120, ECO-1200, ECO-120B, FI-100, FI-100AR, FI-100B, FI-100BBT-UK, FI-120, FI-1200, FI-120AR+DD, FI-120B, FI-120C, FI-120HY-CLINIC, FI-120W, FI-80BBT-UK, FI-900, FI-E-100, LABP-1000, LABP-1200, MF-120 |                 |                     |



1

|                    |                                       |                 |                     |
|--------------------|---------------------------------------|-----------------|---------------------|
| <b>GEV No.</b>     | 505089                                | <b>Ref. No.</b> | 12017331<br>Z401913 |
| <b>description</b> | rinse arm support mounting pos. upper |                 |                     |
| <b>For models:</b> | LVR-10, LVR-14, LVR-20, LVR-20B       |                 |                     |

Зип Общепит  
vsezip.ru  
7(812)987-08-81

|   |  |                 |                                 |
|---|--|-----------------|---------------------------------|
|  |  |                 |                                 |
| 1   |  |                 |                                 |
| <b>GEV No.</b>  | 505134   | <b>Ref. No.</b> | 12023115<br>12038952<br>Z821910 |
| <b>description</b>  | rinse arm support thread M23x1.75 L 61mm WS 32 hose ø 10mm   |                 |                                 |
| <b>For models:</b>  | ECO-1200, ECO-1600, ECO-2300, ECO-2700D, ECO-2700I, ECO-280D, ECO-280I, ECO-3000, ECO-370D, ECO-370I, ECO-4000D, ECO-4000I, ECO-460D, ECO-460I, ECO-550D, ECO-550I, ECO-6000D, ECO-6000I, FI-1200, FI-1600, FI-2300, FI-2700D, FI-2700I, FI-280D, FI-280I, FI-3000, FI-370D, FI-370I, FI-4000D, FI-4000I, FI-460D, FI-460I, FI-550D, FI-550I, FI-6000D, FI-6000I, FI-900 |                 |                                 |

|   |  |                 |                     |
|---|--|-----------------|---------------------|
|  |  |                 |                     |
| 1   |  |                 |                     |
| <b>GEV No.</b>  | 505034   | <b>Ref. No.</b> | 12009829<br>Q152016 |
| <b>description</b>  | Thumb screw thread M5 thread L 7mm ø 20mm H 3mm SS   |                 |                     |
| <b>For models:</b>  | AD-120, AD-120B, AD-120BBTDD-UK, AD-120C, AD-120CW, AD-120HY, AD-15, AD-15D, AD-20C-UK, AD-21, AD-21B, AD-21BDD, AD-21C, AD-21D, AD-21DD, AD-21W, AD-45BBT, AD-48, AD-48B, AD-48BDD, AD-48C, AD-48D, AD-48DD, AD-48HY, AD-48W, AD-64, AD-64B, AD-64BBT, AD-64BDD, AD-64BTDD, AD-64C, AD-64CW, AD-64D, AD-64DD, AD-64HY, AD-72, AD-72W, AD-90, AD-90BA, AD-90BBT, AD-90BDD, AD-90DD, ADE-120, ADE-120B, CO-110, CO-110B, CO-110BDD, CO-110DD, CO-112, CO-112B...(Other models you can see in the webshop) |                 |                     |

|   |  |                 |                     |
|---|--|-----------------|---------------------|
|  |  |                 |                     |
| 1   |  |                 |                     |
| <b>GEV No.</b>  | 505243   | <b>Ref. No.</b> | 12009769<br>Q223108 |
| <b>description</b>  | union nut ø 14mm thread M24x2.5  |                 |                     |
| <b>For models:</b>  | ECO-160, ECO-160D, ECO-160I, ECO-200, ECO-200D, ECO-200H, ECO-200HD, ECO-200HI, ECO-200I, ECO-2700D, ECO-2700I, ECO-280D, ECO-280I, ECO-370D, ECO-370I, ECO-4000D, ECO-4000I, ECO-460D, ECO-460I, ECO-550D, ECO-550I, ECO-6000D, ECO-6000I, FI-160, FI-160AR, FI-160D, FI-160I, FI-200, FI-200AR, FI-200D, FI-200H, FI-200HD, FI-200HI, FI-200I, FI-200W, FI-200WL, FI-200WR, FI-2700D, FI-2700I, FI-280D, FI-280I, FI-370D, FI-370I, FI-4000D, FI-4000I, FI-460D, FI-460I, FI-550D, FI-550I, FI-6000D...(Other models you can see in the webshop) |                 |                     |

|  |  |                 |                          |
|--|--|-----------------|--------------------------|
|  |  |                 |                          |
| 1  |  |                 |                          |
| <b>GEV No.</b>   | 501546   | <b>Ref. No.</b> | 12048173                 |
| <b>description</b>   | wash arm support mounting pos. upper ø 42mm H 78mm L1 340mm  |                 |                          |
| <b>For models:</b>   | AD-125, AD-125HRS, AD-125-SOFT, CO-110, CO-110B, CO-110BDD, CO-110DD, CO-112, CO-112B, CO-112BDD, CO-112DD, CO-170, CO-170B, CO-170BDD, CO-170DD, CO-170HRS, CO-170HRSD, CO-170HRS-SOFT, CO-170-SOFT, CO-172, CO-172B, CO-172BDD, CO-172DD, COP-173, COP-173B, COP-173BDD, COP-173DD, COP-173HRS, COP-173HRSD, COP-173-SOFT, COP-174, COP-174B, COP-174BDD, COP-174DD, COP-174HRS, COP-174HRSD |                 |                          |
| <b>accessories for</b>   | 501546   |                 |                          |
|   | <b>GEV No.</b>   | 532103          | <b>Ref. No.</b> 12049214 |
|  | O-ring EPDM thickness 3.53mm ID ø 13.87mm Qty 10 pcs   |                 |                          |
|   | <b>GEV No.</b>   | 699343          | <b>Ref. No.</b> 12048366 |
|  | gasket L 118mm W 73mm H 9mm thickness 9mm  |                 |                          |

|   |  |                 |                     |
|---|--|-----------------|---------------------|
|  |  |                 |                     |
| 1   |  |                 |                     |
| <b>GEV No.</b>  | 501483   | <b>Ref. No.</b> | 12024859<br>Z310753 |
| <b>description</b>  | wash distributor 4-fold for dishwasher H 29mm ø 45mm ID ø 30mm hole ø 18mm thread L 20mm   |                 |                     |
| <b>For models:</b>  | ECO-2700D, ECO-2700I, ECO-280D, ECO-280I, ECO-370D, ECO-370I, ECO-4000D, ECO-4000I, ECO-460D, ECO-460I, ECO-550D, ECO-550I, ECO-6000D, ECO-6000I, FI-2700D, FI-2700I, FI-280D, FI-280I, FI-370D, FI-370I, FI-4000D, FI-4000I, FI-460D, FI-460I, FI-550D, FI-550I, FI-6000D, FI-6000I |                 |                     |

|  |  |                 |                     |
|--|--|-----------------|---------------------|
|  |  |                 |                     |
| 1  |  |                 |                     |
| <b>GEV No.</b>   | 505181   | <b>Ref. No.</b> | 12024059<br>Z410711 |
| <b>description</b>   | wash pipe L 530mm  |                 |                     |
| <b>For models:</b>   | AD-15, AD-15D, CO-350, CO-350-B, CO-350-B-DD, CO-350-COLD, CO-350-COLD-B, CO-350-COLD-B-DD, CO-350-COLD-DD, CO-350-DD, CO-352-COLD, CO-352-COLD-B, CO-352-COLD-B-DD, CO-352-COLD-DD, LVC-12, LVC-15, LVC-15D |                 |                     |

|  |  |                 |                     |
|--|--|-----------------|---------------------|
|  |  |                 |                     |
| 1  |  |                 |                     |
| <b>GEV No.</b>   | 505182   | <b>Ref. No.</b> | 12025154<br>Z440711 |
| <b>description</b>   | wash pipe L 605mm  |                 |                     |
| <b>For models:</b>   | AD-20C-UK, AD-21, AD-21B, AD-21BDD, AD-21C, AD-21D, AD-21DD, AD-21W, CO-400, CO-400-B, CO-400-B-DD, CO-400-COLD, CO-400-COLD-B, CO-400-COLD-B-DD, CO-400-COLD-DD, CO-400-DD, CO-400-SOFT, CO-402-COLD, CO-402-COLD-B, CO-402-COLD-B-DD, CO-402-COLD-DD, CO-402W, LVC-21, LVC-21B, LVC-21C, LVC-21D, LVC-21W, MF-21 |                 |                     |

Зип Общежит

vsezip.ru

7(812)987-08-81

|   |   |                 |                     |
|---|---|-----------------|---------------------|
|  |   |                 |                     |
| <b>GEV No.</b>  | 505169  | <b>Ref. No.</b> | 12023699<br>Z200706 |
| <b>description</b>  | wash pipe L 681mm   |                 |                     |
| <b>For models:</b>  | AD-45BBT, AD-48, AD-48B, AD-48BDD, AD-48C, AD-48D, AD-48DD, AD-48HY, AD-48W, AD-64, AD-64B, AD-64BBT, AD-64BDD, AD-64BTDD, AD-64C, AD-64CW, AD-64D, AD-64DD, AD-64HY, EASY-500, EASY-500B, EASY-500DD, EASY-500HP, EASY-500HPWBDD, FI-30, FI-30AR, FI-30AR+DD, FI-30B, FI-30B-BT-UK, FI-30-UK, FI-48, FI-48AR, FI-48B, FI-48B-BT-UK, FI-48C, FI-48D, FI-48HY-CLINIC, FI-48W, FI-50, FI-60DD, FI-64, FI-64AR, FI-64B, FI-64B-BT-UK, FI-64C, FI-64D, FI-64HY-CLINIC, FI-64W, MF-48, MF-64 |                 |                     |

|   |                                       |                 |                     |
|---|---------------------------------------|-----------------|---------------------|
|  |                                       |                 |                     |
| <b>GEV No.</b>  | 505188                                | <b>Ref. No.</b> | 12024606<br>Z260701 |
| <b>description</b>  | wash pipe L 790mm                     |                 |                     |
| <b>For models:</b>  | AD-72, AD-72W, FI-72, FI-72AR, FI-72W |                 |                     |

|   |  |                 |                        |
|---|--|-----------------|------------------------|
|  |  |                 |                        |
| <b>GEV No.</b>  | 505320   | <b>Ref. No.</b> | 12040593<br>12Z3107010 |
| <b>description</b>  | wash pipe mounting pos. lower ø 53mm L 40mm suitable for FAGOR   |                 |                        |
| <b>For models:</b>  | ECO-280D, ECO-280I, ECO-370D, ECO-370I, ECO-460D, ECO-460I, ECO-550D, ECO-550I, FI-280D, FI-280I, FI-370D, FI-370I, FI-460D, FI-460I, FI-550D, FI-550I |                 |                        |

|   |  |                 |                        |
|---|--|-----------------|------------------------|
|  |  |                 |                        |
| <b>GEV No.</b>  | 511991   | <b>Ref. No.</b> | 12006587<br>12Z7107090 |
| <b>description</b>  | wash pipe ø 38mm L 730mm SS  |                 |                        |
| <b>For models:</b>  | AD-120, AD-120B, AD-120BBTDD-UK, AD-120C, AD-120CW, AD-120HY, AD-90, AD-90BA, AD-90BBT, AD-90BDD, AD-90DD, ADE-120, ADE-120B, ECO-120, ECO-120B, FI-100, FI-100AR, FI-100B, FI-100BBT-UK, FI-120, FI-120AR+DD, FI-120B, FI-120C, FI-120HY-CLINIC, FI-120W, FI-80, FI-80AR, FI-80BBT-UK, FI-80W, FI-E-100, LABP-1000, LABP-1200, LABP-800, MF-120 |                 |                        |

|  |  |                 |                                 |
|--|--|-----------------|---------------------------------|
|  |  |                 |                                 |
| <b>GEV No.</b>   | 505038   | <b>Ref. No.</b> | 12011257<br>12025122<br>Z650716 |
| <b>description</b>   | wash arm L 490mm nozzles 9 mounting ø 32mm mounting pos. upper/lower   |                 |                                 |
| <b>For models:</b>   | AD-45BBT, AD-48, AD-48B, AD-48BDD, AD-48C, AD-48D, AD-48DD, AD-48HY, AD-48W, AD-505, AD-505-SOFT, AD-64, AD-64B, AD-64BBT, AD-64BDD, AD-64BTDD, AD-64C, AD-64CW, AD-64D, AD-64DD, AD-64HY, AD-72, AD-72W, AD-90, AD-90BA, AD-90BBT, AD-90BDD, AD-90DD, CO-110, CO-110B, CO-110BDD, CO-110DD, CO-112, CO-112B, CO-112BDD, CO-112DD, CO-500, CO-500B, CO-500BDD, CO-500DD, CO-501, CO-501B, CO-501BDD, CO-501DD, CO-501-SOFT, CO-502B, CO-502BDD, CO-502DD, CO-502W, COP-503...(Other models you can see in the webshop) |                 |                                 |

|   |  |                 |                                    |
|---|--|-----------------|------------------------------------|
|  |  |                 |                                    |
| <b>GEV No.</b>  | 505039   | <b>Ref. No.</b> | 12003421<br>12038375<br>12Z7107010 |
| <b>description</b>  | wash arm L 525mm nozzles 14 mounting ø 50mm mounting pos. upper/lower  |                 |                                    |
| <b>For models:</b>  | AD-120, AD-120B, AD-120BBTDD-UK, AD-120C, AD-120CW, AD-120HY, AD-125, AD-125HRS, AD-125-SOFT, ADE-120, ADE-120B, CO-142W, CO-142WDD, CO-170, CO-170B, CO-170BDD, CO-170DD, CO-170HRS, CO-170HRSDD, CO-170HRS-SOFT, CO-170-SOFT, CO-172, CO-172B, CO-172BDD, CO-172DD, COP-173, COP-173B, COP-173BDD, COP-173DD, COP-173HRS, COP-173HRSDD, COP-173-SOFT, COP-174, COP-174B, COP-174BDD, COP-174DD, COP-174HRS, COP-174HRSDD, COP-174W, COP-174WHRS, ECO-120, ECO-120B, FI-100, FI-100AR, FI-100B, FI-100BBT-UK, FI-120, FI-120AR+DD, FI-120B, FI-120C...(Other models you can see in the webshop) |                 |                                    |

|   |  |                 |                     |
|---|--|-----------------|---------------------|
|  |  |                 |                     |
| <b>GEV No.</b>  | 505031   | <b>Ref. No.</b> | 12023710<br>Z400711 |
| <b>description</b>  | opposite support   |                 |                     |
| <b>For models:</b>  | AD-15, AD-15D, AD-20C-UK, AD-21, AD-21B, AD-21BDD, AD-21C, AD-21D, AD-21DD, AD-21W, CO-350, CO-350-B, CO-350-B-DD, CO-350-COLD, CO-350-COLD-B, CO-350-COLD-B-DD, CO-350-COLD-DD, CO-350-DD, CO-352-COLD, CO-352-COLD-B, CO-352-COLD-B-DD, CO-352-COLD-DD, CO-400, CO-400-B, CO-400-B-DD, CO-400-COLD, CO-400-COLD-B, CO-400-COLD-B-DD, CO-400-COLD-DD, CO-400-DD, CO-400-SOFT, CO-402-COLD, CO-402-COLD-B, CO-402-COLD-B-DD, CO-402-COLD-DD, CO-402W, ECO-2700D, ECO-2700I, ECO-280D, ECO-280I, ECO-370D, ECO-370I, ECO-4000D, ECO-4000I, ECO-460D, ECO-460I, ECO-550D, ECO-550I, ECO-6000D, ECO-6000I...(Other models you can see in the webshop) |                 |                     |

Зип Общепит

vsezip.ru

7(812)987-08-81

|   |   |                 |                     |
|---|---|-----------------|---------------------|
|  |   |                 |                     |
| <b>GEV No.</b>  | 505046  | <b>Ref. No.</b> | 12024006<br>Z201906 |
| <b>description</b>  | opposite support rinse jet  |                 |                     |
| <b>For models:</b>  | AD-15, AD-15D, AD-90, AD-90BA, AD-90BDD, AD-90DD, FI-30, FI-30AR, FI-30AR+DD, FI-30B, FI-30B-BT-UK, FI-30-UK, FI-48, FI-48A, FI-48B, FI-48B-BT-UK, FI-48C, FI-48D, FI-48HY-CLINIC, FI-48W, FI-60DD, FI-80, FI-80AR, FI-80W, FI-E-100, LABP-800, LVC-12, LVC-15, LVC-15D, LVC-21, LVC-21B, LVC-21C, LVC-21D, LVC-21W, LVR-10, LVR-14, LVR-20, LVR-20B, MF-21 |                 |                     |

|   |  |                 |                     |
|---|--|-----------------|---------------------|
|  |  |                 |                     |
| <b>GEV No.</b>  | 505045   | <b>Ref. No.</b> | 12009912<br>Q307036 |
| <b>description</b>  | O-ring EPDM thickness 1.78mm ID ø 5.28mm Qty 1 pcs   |                 |                     |
| <b>For models:</b>  | AD-15, AD-15D, AD-90, AD-90BA, AD-90BDD, AD-90DD, COG-202, EASY-500, EASY-500B, EASY-500DD, EASY-500HP, EASY-500HPWBDD, FI-30, FI-30AR, FI-30AR+DD, FI-30B, FI-30B-BT-UK, FI-30-UK, FI-48, FI-48AR, FI-48B, FI-48B-BT-UK, FI-48C, FI-48D, FI-48HY-CLINIC, FI-48W, FI-60DD, FI-80, FI-80AR, FI-80W, FI-E-100, HGC-20-21, HGP-10-21, HGP-20-21, HGV-20-21, LABP-800, LF-13MPP, LF-18MPP, LF-25MPP, LF-8MPP, LVC-12, LVC-15, LVC-15D, LVC-21, LVC-21B, LVC-21D, LVC-21W, LVR-10, LVR-14, LVR-20...(Other models you can see in the webshop) |                 |                     |

|   |   |                 |                     |
|---|---|-----------------|---------------------|
|  |   |                 |                     |
| <b>GEV No.</b>  | 505065  | <b>Ref. No.</b> | 12020476<br>Z411902 |
| <b>description</b>  | rinse arm   |                 |                     |
| <b>For models:</b>  | CO-350, CO-350-B, CO-350-B-DD, CO-350-COLD, CO-350-COLD-B, CO-350-COLD-B-DD, CO-350-COLD-DD, CO-350-DD, CO-352-COLD, CO-352-COLD-B, CO-352-COLD-B-DD, CO-352-COLD-DD, LVC-12, LVC-15, LVC-15D |                 |                     |

|   |   |                 |                     |
|---|---|-----------------|---------------------|
|  |   |                 |                     |
| <b>GEV No.</b>  | 505042  | <b>Ref. No.</b> | 12025253<br>Z461902 |
| <b>description</b>  | rinse arm L 144mm nozzles 2 mounting ø 11.7mm mounting pos. „A“ |                 |                     |
| <b>For models:</b>  | AD-15, AD-15D, LVC-12, LVC-15, LVC-15D                          |                 |                     |

|   |  |                 |                     |
|---|--|-----------------|---------------------|
|  |  |                 |                     |
| <b>GEV No.</b>  | 505063   | <b>Ref. No.</b> | 12024137<br>Z461901 |
| <b>description</b>  | rinse arm L 144mm nozzles 2 mounting ø 7mm mounting pos. „B“ |                 |                     |
| <b>For models:</b>  | AD-15, AD-15D, LVC-12, LVC-15, LVC-15D                       |                 |                     |

|   |   |                 |                     |
|---|---|-----------------|---------------------|
|  |   |                 |                     |
| <b>GEV No.</b>  | 505066  | <b>Ref. No.</b> | 12020475<br>Z411901 |
| <b>description</b>  | rinse arm L 145mm   |                 |                     |
| <b>For models:</b>  | CO-350, CO-350-B, CO-350-B-DD, CO-350-COLD, CO-350-COLD-B, CO-350-COLD-B-DD, CO-350-COLD-DD, CO-350-DD, CO-352-COLD, CO-352-COLD-B, CO-352-COLD-B-DD, CO-352-COLD-DD, LVC-12, LVC-15, LVC-15D |                 |                     |



|   |   |                 |                     |
|---|---|-----------------|---------------------|
|  |   |                 |                     |
| <b>GEV No.</b>  | 505043  | <b>Ref. No.</b> | 12022613<br>Z441901 |
| <b>description</b>  | rinse arm L 166mm nozzles 2 mounting ø 11.5mm mounting pos. „A“   |                 |                     |
| <b>For models:</b>  | AD-20C-UK, AD-21, AD-21B, AD-21BDD, AD-21C, AD-21D, AD-21DD, AD-21W, CO-400, CO-400-B, CO-400-B-DD, CO-400-COLD, CO-400-COLD-B, CO-400-COLD-B-DD, CO-400-COLD-DD, CO-400-DD, CO-400-SOFT, CO-402-COLD, CO-402-COLD-B, CO-402-COLD-B-DD, CO-402-COLD-DD, CO-402W, LVC-15D, LVC-21, LVC-21B, LVC-21C, LVC-21D, LVC-21W, MF-21 |                 |                     |

|  |   |                 |                     |
|--|---|-----------------|---------------------|
|  |   |                 |                     |
| <b>GEV No.</b>   | 505064  | <b>Ref. No.</b> | 12022710<br>Z441902 |
| <b>description</b>   | rinse arm L 166mm nozzles 3 mounting ø 11.5mm mounting pos. „B“   |                 |                     |
| <b>For models:</b>   | AD-20C-UK, AD-21, AD-21B, AD-21BDD, AD-21C, AD-21D, AD-21DD, AD-21W, CO-400, CO-400-B, CO-400-B-DD, CO-400-COLD, CO-400-COLD-B, CO-400-COLD-B-DD, CO-400-COLD-DD, CO-400-DD, CO-400-SOFT, CO-402-COLD, CO-402-COLD-B, CO-402-COLD-B-DD, CO-402-COLD-DD, CO-402W, LVC-15D, LVC-21, LVC-21B, LVC-21C, LVC-21D, LVC-21W, MF-21 |                 |                     |

|   |  |                 |                                   |
|---|--|-----------------|-----------------------------------|
|  |  |                 |                                   |
| <b>GEV No.</b>  | 505407                                     | <b>Ref. No.</b> | 12023525<br>Z448712<br>Z448712000 |
| <b>description</b>  | rinse arm L 166mm ø 12mm plastic nozzles 3 |                 |                                   |





Зип Общепит  
vsezip.ru  
+7(812)987-08-81

|   |  |                 |                                     |
|---|--|-----------------|-------------------------------------|
|  |  |                 |                                     |
| <b>GEV No.</b>  | 505044   | <b>Ref. No.</b> | 12024077<br>Z201905                 |
| <b>description</b>  | rinse jet  |                 |                                     |
| <b>For models:</b>  | AD-15, AD-15D, AD-90, AD-90BA, AD-90BBT, AD-90BDD, AD-90DD, EASY-500, EASY-500B, EASY-500DD, EASY-500HP, EASY-500HPWBDD, FI-30, FI-30AR, FI-30AR+DD, FI-30B, FI-30B-BT-UK, FI-30-UK, FI-48, FI-48AR, FI-48B, FI-48B-BT-UK, FI-48C, FI-48D, FI-48HY-CLINIC, FI-48W, FI-60DD, FI-80, FI-80AR, FI-80BBT-UK, FI-80W, FI-E-100, LABP-800, LVC-12, LVC-15, LVC-15D, LVC-21, LVC-21B, LVC-21C, LVC-21D, LVC-21W, LVR-10, LVR-14, LVR-20, LVR-20B, MF-21 |                 |                                     |
| <b>accessories for</b>  | 505044   |                 |                                     |
|  | <b>GEV No.</b>   | 505045          | <b>Ref. No.</b> 12009912<br>Q307036 |
|   | O-ring EPDM thickness 1.78mm ID ø 5.28mm Qty 1 pcs   |                 |                                     |
|  | <b>GEV No.</b>   | 505046          | <b>Ref. No.</b> 12024006<br>Z201906 |
|   | opposite support rinse jet   |                 |                                     |

|   |   |                 |                     |
|---|---|-----------------|---------------------|
|  |   |                 |                     |
| <b>GEV No.</b>  | 505103  | <b>Ref. No.</b> | 12024252<br>Z211903 |
| <b>description</b>  | rinse jet   |                 |                     |
| <b>For models:</b>  | AD-120, AD-120B, AD-120BBTDD-UK, AD-120C, AD-120CW, AD-120HY, AD-20C-UK, AD-21, AD-21B, AD-21BDD, AD-21C, AD-21D, AD-21DD, AD-21W, AD-45BBT, AD-48, AD-48B, AD-48BDD, AD-48C, AD-48D, AD-48DD, AD-48HY, AD-48W, AD-64, AD-64B, AD-64BBT, AD-64BDD, AD-64BTDD, AD-64C, AD-64CW, AD-64D, AD-64DD, AD-64HY, AD-72, AD-72W, AD-90, AD-90BA, AD-90BDD, AD-90DD, ADE-120, ADE-120B, CO-110, CO-110B, CO-110BDD, CO-110DD, CO-112, CO-112B, CO-112BDD, CO-112DD, CO-142W...(Other models you can see in the webshop) |                 |                     |



|   |   |                 |                     |
|---|---|-----------------|---------------------|
|  |   |                 |                     |
| <b>GEV No.</b>  | 505147  | <b>Ref. No.</b> | 12019827<br>Z410706 |
| <b>description</b>  | wash arm  |                 |                     |
| <b>For models:</b>  | CO-350, CO-350-B, CO-350-B-DD, CO-350-COLD, CO-350-COLD-B, CO-350-COLD-B-DD, CO-350-COLD-DD, CO-350-DD, CO-352-COLD, CO-352-COLD-B, CO-352-COLD-B-DD, CO-352-COLD-DD, LVC-12, LVC-15, LVC-15D |                 |                     |

|   |  |                 |                     |
|---|--|-----------------|---------------------|
|  |  |                 |                     |
| <b>GEV No.</b>  | 505054   | <b>Ref. No.</b> | 12025251<br>Z460701 |
| <b>description</b>  | wash arm L 140mm nozzles 2 mounting ø 21.5mm mounting pos. „B” |                 |                     |
| <b>For models:</b>  | AD-15, AD-15D, LVC-12, LVC-15, LVC-15D                         |                 |                     |

|   |  |                 |                     |
|---|--|-----------------|---------------------|
|  |  |                 |                     |
| <b>GEV No.</b>  | 505036   | <b>Ref. No.</b> | 12024138<br>Z460702 |
| <b>description</b>  | wash arm L 140mm nozzles 3 mounting ø 21.5mm mounting pos. „A” |                 |                     |
| <b>For models:</b>  | AD-15, AD-15D, LVC-12, LVC-15, LVC-15D                         |                 |                     |

|   |  |                 |                     |
|---|--|-----------------|---------------------|
|  |  |                 |                     |
| <b>GEV No.</b>  | 505037   | <b>Ref. No.</b> | 12022381<br>Z440706 |
| <b>description</b>  | wash arm L 163mm nozzles 3 mounting ø 18mm mounting pos. „A”   |                 |                     |
| <b>For models:</b>  | AD-20C-UK, AD-21, AD-21B, AD-21BDD, AD-21C, AD-21D, AD-21DD, AD-21W, CO-400, CO-400-B, CO-400-B-DD, CO-400-COLD, CO-400-COLD-B, CO-400-COLD-B-DD, CO-400-COLD-DD, CO-400-DD, CO-400-SOFT, CO-402-COLD, CO-402-COLD-B, CO-402-COLD-B-DD, CO-402-COLD-DD, CO-402W, LVC-21, LVC-21B, LVC-21C, LVC-21D, LVC-21W, MF-21 |                 |                     |

|   |  |                 |                     |
|---|--|-----------------|---------------------|
|  |  |                 |                     |
| <b>GEV No.</b>  | 505055   | <b>Ref. No.</b> | 12022382<br>Z440707 |
| <b>description</b>  | wash arm L 163mm nozzles 3 mounting ø 18mm mounting pos. „B”   |                 |                     |
| <b>For models:</b>  | AD-20C-UK, AD-21, AD-21B, AD-21BDD, AD-21C, AD-21D, AD-21DD, AD-21W, CO-400, CO-400-B, CO-400-B-DD, CO-400-COLD, CO-400-COLD-B, CO-400-COLD-B-DD, CO-400-COLD-DD, CO-400-DD, CO-400-SOFT, CO-402-COLD, CO-402-COLD-B, CO-402-COLD-B-DD, CO-402-COLD-DD, CO-402W, LVC-21, LVC-21B, LVC-21C, LVC-21D, LVC-21W, MF-21 |                 |                     |

|   |  |                 |                                     |
|---|--|-----------------|-------------------------------------|
|  |  |                 |                                     |
| <b>GEV No.</b>  | 505068   | <b>Ref. No.</b> | 12025216<br>Z410704                 |
| <b>description</b>  | wash arm boss  |                 |                                     |
| <b>For models:</b>  | AD-15, AD-15D, AD-20C-UK, AD-21, AD-21B, AD-21BDD, AD-21C, AD-21D, AD-21DD, AD-21W, CO-350, CO-350-B, CO-350-B-DD, CO-350-COLD, CO-350-COLD-B, CO-350-COLD-B-DD, CO-350-COLD-DD, CO-350-DD, CO-352-COLD, CO-352-COLD-B, CO-352-COLD-B-DD, CO-352-COLD-DD, CO-400, CO-400-B, CO-400-B-DD, CO-400-COLD, CO-400-COLD-B, CO-400-COLD-B-DD, CO-400-COLD-DD, CO-400-DD, CO-400-SOFT, CO-402-COLD, CO-402-COLD-B, CO-402-COLD-B-DD, CO-402-COLD-DD, CO-402W, LVC-12, LVC-15, LVC-15D, LVC-21, LVC-21B, LVC-21C, LVC-21D, LVC-21W, MF-21 |                 |                                     |
| <b>accessories for</b>  | 505068   |                 |                                     |
|  | <b>GEV No.</b>   | 505035          | <b>Ref. No.</b> 12024086<br>Z410705 |
|   | bushing  |                 |                                     |



1

|   |  |                 |                                     |
|---|--|-----------------|-------------------------------------|
| <b>GEV No.</b>  | 505033   | <b>Ref. No.</b> | 12023732<br>Z400709                 |
| <b>description</b>  | wash jet   |                 |                                     |
| <b>For models:</b>  | AD-15, AD-15D, AD-20C-UK, AD-21, AD-21B, AD-21BDD, AD-21C, AD-21D, AD-21DD, AD-21W, CO-350, CO-350-B, CO-350-B-DD, CO-350-COLD, CO-350-COLD-B, CO-350-COLD-B-DD, CO-350-COLD-DD, CO-350-DD, CO-352-COLD, CO-352-COLD-B, CO-352-COLD-B-DD, CO-352-COLD-DD, CO-400, CO-400-B, CO-400-B-DD, CO-400-COLD, CO-400-COLD-B, CO-400-COLD-B-DD, CO-400-COLD-DD, CO-400-DD, CO-400-SOFT, CO-402-COLD, CO-402-COLD-B, CO-402-COLD-B-DD, CO-402-COLD-DD, CO-402W, LVC-12, LVC-15, LVC-15D, LVC-21, LVC-21B, LVC-21C, LVC-21D, LVC-21W, LVR-10, LVR-14, LVR-14D, LVR-20, LVR-20B, LVR-20D...(Other models you can see in the webshop) |                 |                                     |
| <b>accessories for</b>  | 505033   |                 |                                     |
|  | <b>GEV No.</b>   | 505031          | <b>Ref. No.</b> 12023710<br>Z400711 |
|   | opposite support   |                 |                                     |



1

|                    |  |                 |                     |
|--------------------|--|-----------------|---------------------|
| <b>GEV No.</b>     | 505046   | <b>Ref. No.</b> | 12024006<br>Z201906 |
| <b>description</b> | opposite support rinse jet   |                 |                     |
| <b>For models:</b> | AD-15, AD-15D, AD-90, AD-90BA, AD-90BDD, AD-90DD, FI-30, FI-30AR, FI-30AR+DD, FI-30B, FI-30B-BT-UK, FI-30-UK, FI-48, FI-48AR, FI-48B, FI-48B-BT-UK, FI-48C, FI-48D, FI-48HY-CLINIC, FI-48W, FI-60DD, FI-80, FI-80AR, FI-80W, FI-E-100, LABP-800, LVC-12, LVC-15, LVC-15D, LVC-21, LVC-21B, LVC-21C, LVC-21D, LVC-21W, LVR-10, LVR-14, LVR-20, LVR-20B, MF-21 |                 |                     |



1

|                    |  |                 |                     |
|--------------------|--|-----------------|---------------------|
| <b>GEV No.</b>     | 505045   | <b>Ref. No.</b> | 12009912<br>Q307036 |
| <b>description</b> | O-ring EPDM thickness 1.78mm ID ø 5.28mm Qty 1 pcs   |                 |                     |
| <b>For models:</b> | AD-15, AD-15D, AD-90, AD-90BA, AD-90BDD, AD-90DD, COG-202, EASY-500, EASY-500B, EASY-500DD, EASY-500HP, EASY-500HPWBDD, FI-30, FI-30AR, FI-30AR+DD, FI-30B, FI-30B-BT-UK, FI-30-UK, FI-48, FI-48AR, FI-48B, FI-48B-BT-UK, FI-48C, FI-48D, FI-48HY-CLINIC, FI-48W, FI-60DD, FI-80, FI-80AR, FI-80W, FI-E-100, HGC-20-21, HGP-10-21, HGP-20-21, HGV-20-21, LABP-800, LF-13MPP, LF-18MPP, LF-25MPP, LF-8MPP, LVC-12, LVC-15, LVC-15D, LVC-21, LVC-21B, LVC-21D, LVC-21W, LVR-10, LVR-14, LVR-20...(Other models you can see in the webshop) |                 |                     |



1

|                    |   |                 |                                 |
|--------------------|---|-----------------|---------------------------------|
| <b>GEV No.</b>     | 505061  | <b>Ref. No.</b> | 12022442<br>12113596<br>Z201902 |
| <b>description</b> | rinse arm L 220mm nozzles 3 mounting ø 11.7mm mounting pos. left  |                 |                                 |
| <b>For models:</b> | AD-120, AD-120B, AD-120BBTDD-UK, AD-120C, AD-120CW, AD-120HY, AD-45BBT, AD-48, AD-48B, AD-48BDD, AD-48C, AD-48D, AD-48DD, AD-48HY, AD-48W, AD-64, AD-64B, AD-64BBT, AD-64BDD, AD-64BTDD, AD-64C, AD-64CW, AD-64D, AD-64DD, AD-64HY, AD-72, AD-72W, AD-90, AD-90BA, AD-90BBT, AD-90BDD, AD-90DD, ADE-120, ADE-120B, CO-110, CO-110B, CO-110BDD, CO-110DD, CO-112, CO-112B, CO-112BDD, CO-112DD, CO-142W, CO-142WDD, CO-170, CO-170B, CO-170BDD, CO-170DD, CO-170HRS, CO-170HRSDD...(Other models you can see in the webshop) |                 |                                 |

Зип Общепит

vsezip.ru

+7(812)987-08-81



GEV No.

505062

Ref. No.

12022441  
12113595  
Z201901

description

rinse arm L 220mm nozzles 3 mounting ø 12mm mounting pos. right

For models:

AD-120, AD-120B, AD-120BBTDD-UK, AD-120C, AD-120CW, AD-120HY, AD-45BBT, AD-48, AD-48B, AD-48BDD, AD-48C, AD-48D, AD-48DD, AD-48HY, AD-48W, AD-64, AD-64B, AD-64BBT, AD-64BDD, AD-64BTDD, AD-64C, AD-64CW, AD-64D, AD-64DD, AD-64HY, AD-72, AD-72W, AD-90, AD-90BA, AD-90BBT, AD-90BDD, AD-90DD, ADE-120, ADE-120B, CO-110, CO-110B, CO-110BDD, CO-110DD, CO-112, CO-112B, CO-112BDD, CO-112DD, CO-142W, CO-142WDD, CO-170, CO-170B, CO-170BDD, CO-170DD, CO-170HRS, CO-170HRSDD...(Other models you can see in the webshop)





1

|   |   |                 |   |
|---|---|-----------------|---|
| <b>GEV No.</b>  | 505069  | <b>Ref. No.</b> | 12024470<br>Z201903                             |
| <b>description</b>  | rinse arm boss mounting pos. upper/lower ø 12mm H 22mm L 59mm   |                 |   |
| <b>For models:</b>  | AD-120, AD-120B, AD-120BBTDD-UK, AD-120C, AD-120CW, AD-120HY, AD-45BBT, AD-48, AD-48B, AD-48BDD, AD-48C, AD-48D, AD-48DD, AD-48HY, AD-48W, AD-64, AD-64B, AD-64BBT, AD-64BDD, AD-64BTDD, AD-64C, AD-64CW, AD-64D, AD-64DD, AD-64HY, AD-72, AD-72W, AD-90, AD-90BA, AD-90BBT, AD-90BDD, AD-90DD, ADE-120, ADE-120B, CO-110, CO-110B, CO-110BDD, CO-110DD, CO-112, CO-112B, CO-112BDD, CO-112DD, CO-142W, CO-142WDD, CO-170, CO-170B, CO-170BDD, CO-170DD, CO-170HRS, CO-170HRSDD...(Other models you can see in the webshop) |                 |   |
| <b>accessories for</b>  | 505069  |                 |   |
|  | <b>GEV No.</b>  | 560076          | <b>Ref. No.</b> 12009852<br>12010293<br>Q152024 |
|   | countersunk screw thread M4 L 10mm SS DIN 963/ISO 2009 Qty 20 pcs intake slotted head ø 7.5mm   |                 |   |





1

|   |  |                 |                                     |
|---|--|-----------------|-------------------------------------|
| <b>GEV No.</b>  | 505044   | <b>Ref. No.</b> | 12024077<br>Z201905                 |
| <b>description</b>  | rinse jet  |                 |                                     |
| <b>For models:</b>  | AD-15, AD-15D, AD-90, AD-90BA, AD-90BBT, AD-90BDD, AD-90DD, EASY-500, EASY-500B, EASY-500DD, EASY-500HP, EASY-500HPWBDD, FI-30, FI-30AR, FI-30AR+DD, FI-30B, FI-30B-BT-UK, FI-30-UK, FI-48, FI-48AR, FI-48B, FI-48B-BT-UK, FI-48C, FI-48D, FI-48HY-CLINIC, FI-48W, FI-60DD, FI-80, FI-80AR, FI-80BBT-UK, FI-80W, FI-E-100, LABP-800, LVC-12, LVC-15, LVC-15D, LVC-21, LVC-21B, LVC-21C, LVC-21D, LVC-21W, LVR-10, LVR-14, LVR-20, LVR-20B, MF-21 |                 |                                     |
| <b>accessories for</b>  | 505044   |                 |                                     |
|  | <b>GEV No.</b>   | 505045          | <b>Ref. No.</b> 12009912<br>Q307036 |
|   | O-ring EPDM thickness 1.78mm ID ø 5.28mm Qty 1 pcs   |                 |                                     |
|  | <b>GEV No.</b>   | 505046          | <b>Ref. No.</b> 12024006<br>Z201906 |
|   | opposite support rinse jet   |                 |                                     |





Зип Общепит  
vsezip.ru  
+7(812)987-08-81

|   |                                   |                 |                     |
|---|-----------------------------------|-----------------|---------------------|
|  |                                   |                 |                     |
| 1   |                                   |                 |                     |
| <b>GEV No.</b>  | 505136                            | <b>Ref. No.</b> | 12018104<br>Z680742 |
| <b>description</b>  | wash arm L 225mm nozzles 4 ø 25mm |                 |                     |
| <b>For models:</b>  | ECO-1200, FI-1200, FI-900         |                 |                     |

|   |   |                 |                     |
|---|---|-----------------|---------------------|
|  |   |                 |                     |
| 1   |   |                 |                     |
| <b>GEV No.</b>  | 505067  | <b>Ref. No.</b> | 12017301<br>Z401915 |
| <b>description</b>  | rinse arm mounting pos. upper/lower L 157mm mounting ø 11.5mm nozzles 4 |                 |                     |
| <b>For models:</b>  | LVR-10, LVR-14  |                 |                     |



|   |                                   |                 |                     |
|---|-----------------------------------|-----------------|---------------------|
|  |                                   |                 |                     |
| 1   |                                   |                 |                     |
| <b>GEV No.</b>  | 505217                            | <b>Ref. No.</b> | 12018636<br>Z680741 |
| <b>description</b>  | wash arm L 225mm nozzles 4 ø 25mm |                 |                     |
| <b>For models:</b>  | ECO-1200, FI-1200, FI-900         |                 |                     |

|   |   |                 |                     |
|---|---|-----------------|---------------------|
|  |   |                 |                     |
| 1   |   |                 |                     |
| <b>GEV No.</b>  | 505090  | <b>Ref. No.</b> | 12040402<br>Z421904 |
| <b>description</b>  | rinse arm mounting pos. upper/lower L 175mm mounting ø 10mm nozzles 5 |                 |                     |
| <b>For models:</b>  | LVR-20, LVR-20B   |                 |                     |

|   |                                    |                 |                     |
|---|------------------------------------|-----------------|---------------------|
|  |                                    |                 |                     |
| 1   |                                    |                 |                     |
| <b>GEV No.</b>  | 505216                             | <b>Ref. No.</b> | 12039835<br>Z680745 |
| <b>description</b>  | wash arm boss L 90mm W 90mm H 38mm |                 |                     |
| <b>For models:</b>  | ECO-1200, FI-1200, FI-900          |                 |                     |

|   |  |                 |                     |
|---|--|-----------------|---------------------|
|  |  |                 |                     |
| 1   |  |                 |                     |
| <b>GEV No.</b>  | 505044   | <b>Ref. No.</b> | 12024077<br>Z201905 |
| <b>description</b>  | rinse jet  |                 |                     |
| <b>For models:</b>  | AD-15, AD-15D, AD-90, AD-90BA, AD-90BBT, AD-90BDD, AD-90DD, EASY-500, EASY-500B, EASY-500DD, EASY-500HP, EASY-500HPWBDD, FI-30, FI-30AR, FI-30AR+DD, FI-30B, FI-30B-BT-UK, FI-30-UK, FI-48, FI-48AR, FI-48B, FI-48B-BT-UK, FI-48C, FI-48D, FI-48HY-CLINIC, FI-48W, FI-60DD, FI-80, FI-80AR, FI-80BBT-UK, FI-80W, FI-E-100, LABP-800, LVC-12, LVC-15, LVC-15D, LVC-21, LVC-21B, LVC-21C, LVC-21D, LVC-21W, LVR-10, LVR-14, LVR-20, LVR-20B, MF-21 |                 |                     |

|   |                           |                 |                     |
|---|---------------------------|-----------------|---------------------|
|  |                           |                 |                     |
| 1   |                           |                 |                     |
| <b>GEV No.</b>  | 505267                    | <b>Ref. No.</b> | 12017814<br>Z600705 |
| <b>description</b>  | wash jet for pipe ø 25mm  |                 |                     |
| <b>For models:</b>  | ECO-1200, FI-1200, FI-900 |                 |                     |

|   |                |        |                 |                     |
|---|----------------|--------|-----------------|---------------------|
| <b>accessories for</b> 505044   |                |        |                 |                     |
|  | <b>GEV No.</b> | 505045 | <b>Ref. No.</b> | 12009912<br>Q307036 |
| O-ring EPDM thickness 1.78mm ID ø 5.28mm Qty 1 pcs                                  |                |        |                 |                     |
|  | <b>GEV No.</b> | 505046 | <b>Ref. No.</b> | 12024006<br>Z201906 |
| opposite support rinse jet  |                |        |                 |                     |

|   |  |                 |                     |
|---|--|-----------------|---------------------|
|  |  |                 |                     |
| 1   |  |                 |                     |
| <b>GEV No.</b>  | 505046   | <b>Ref. No.</b> | 12024006<br>Z201906 |
| <b>description</b>  | opposite support rinse jet   |                 |                     |
| <b>For models:</b>  | AD-15, AD-15D, AD-90, AD-90BA, AD-90BDD, AD-90DD, FI-30, FI-30AR, FI-30AR+DD, FI-30B, FI-30B-BT-UK, FI-30-UK, FI-48, FI-48AR, FI-48B, FI-48B-BT-UK, FI-48C, FI-48D, FI-48HY-CLINIC, FI-48W, FI-60DD, FI-80, FI-80AR, FI-80W, FI-E-100, LABP-800, LVC-12, LVC-15, LVC-15D, LVC-21, LVC-21B, LVC-21C, LVC-21D, LVC-21W, LVR-10, LVR-14, LVR-20, LVR-20B, MF-21 |                 |                     |

|   |  |                 |                     |
|---|--|-----------------|---------------------|
|  |  |                 |                     |
| 1   |  |                 |                     |
| <b>GEV No.</b>  | 505046   | <b>Ref. No.</b> | 12024006<br>Z201906 |
| <b>description</b>  | opposite support rinse jet   |                 |                     |
| <b>For models:</b>  | AD-15, AD-15D, AD-90, AD-90BA, AD-90BDD, AD-90DD, FI-30, FI-30AR, FI-30AR+DD, FI-30B, FI-30B-BT-UK, FI-30-UK, FI-48, FI-48AR, FI-48B, FI-48B-BT-UK, FI-48C, FI-48D, FI-48HY-CLINIC, FI-48W, FI-60DD, FI-80, FI-80AR, FI-80W, FI-E-100, LABP-800, LVC-12, LVC-15, LVC-15D, LVC-21, LVC-21B, LVC-21C, LVC-21D, LVC-21W, LVR-10, LVR-14, LVR-20, LVR-20B, MF-21 |                 |                     |

|   |  |                 |                     |
|---|--|-----------------|---------------------|
|  |  |                 |                     |
| 1   |  |                 |                     |
| <b>GEV No.</b>  | 505045   | <b>Ref. No.</b> | 12009912<br>Q307036 |
| <b>description</b>  | O-ring EPDM thickness 1.78mm ID ø 5.28mm Qty 1 pcs   |                 |                     |
| <b>For models:</b>  | AD-15, AD-15D, AD-90, AD-90BA, AD-90BDD, AD-90DD, COG-202, EASY-500, EASY-500B, EASY-500DD, EASY-500HP, EASY-500HPWBDD, FI-30, FI-30AR, FI-30AR+DD, FI-30B, FI-30B-BT-UK, FI-30-UK, FI-48, FI-48AR, FI-48B, FI-48B-BT-UK, FI-48C, FI-48D, FI-48HY-CLINIC, FI-48W, FI-60DD, FI-80, FI-80AR, FI-80W, FI-E-100, HGC-20-21, HGP-10-21, HGP-20-21, HGV-20-21, LABP-800, LF-13MPP, LF-18MPP, LF-25MPP, LF-8MPP, LVC-12, LVC-15, LVC-15D, LVC-21, LVC-21B, LVC-21D, LVC-21W, LVR-10, LVR-14, LVR-20...(Other models you can see in the webshop) |                 |                     |

Зип Общепит



vsezip.ru

812)987-08-81

|   |  |                 |                     |
|---|--|-----------------|---------------------|
|  |  |                 |                     |
| <b>GEV No.</b>  | 505045   | <b>Ref. No.</b> | 12009912<br>Q307036 |
| <b>description</b>  | O-ring EPDM thickness 1.78mm ID ø 5.28mm Qty 1 pcs   |                 |                     |
| <b>For models:</b>  | AD-15, AD-15D, AD-90, AD-90BA, AD-90BDD, AD-90DD, COC-202, EASY-500, EASY-500B, EASY-500DD, EASY-500HP, EASY-500HPWBDD, FI-30, FI-30AR, FI-30AR+DD, FI-30B, FI-30B-BT-UK, FI-30-UK, FI-48, FI-48AR, FI-48B, FI-48B-BT-UK, FI-48C, FI-48D, FI-48HY-CLINIC, FI-48W, FI-60DD, FI-80, FI-80AR, FI-80W, FI-E-100, HGC-20-21, HGP-10-21, HGP-20-21, HGV-20-21, LABP-800, LF-13MPP, LF-18MPP, LF-25MPP, LF-8MPP, LVC-12, LVC-15, LVC-15D, LVC-21, LVC-21B, LVC-21D, LVC-21W, LVR-10, LVR-14, LVR-20...(Other models you can see in the webshop) |                 |                     |

|   |   |                 |                     |
|---|---|-----------------|---------------------|
|  |   |                 |                     |
| <b>GEV No.</b>  | 505265  | <b>Ref. No.</b> | 12023524<br>Z208712 |
| <b>description</b>  | rinse arm L 230mm nozzles 3   |                 |                     |
| <b>For models:</b>  | AD-90, AD-90BA, AD-90BBT, AD-90BDD, AD-90DD, EASY-500, EASY-500B, EASY-500DD, EASY-500HP, EASY-500HPWBDD, FI-30, FI-30AR, FI-30AR+DD, FI-30B, FI-30B-BT-UK, FI-30-UK, FI-48, FI-48AR, FI-48B, FI-48B-BT-UK, FI-48C, FI-48D, FI-48HY-CLINIC, FI-48W, FI-60DD, FI-80, FI-80AR, FI-80W, FI-E-100, LABP-800 |                 |                     |

|  |   |                 |                     |
|--|---|-----------------|---------------------|
|  |   |                 |                     |
| <b>GEV No.</b>   | 505266  | <b>Ref. No.</b> | 12023527<br>Z208713 |
| <b>description</b>   | rinse arm L 230mm nozzles 3 right   |                 |                     |
| <b>For models:</b>   | AD-90, AD-90BA, AD-90BBT, AD-90BDD, AD-90DD, EASY-500, EASY-500B, EASY-500DD, EASY-500HP, EASY-500HPWBDD, FI-30, FI-30AR, FI-30AR+DD, FI-30B, FI-30B-BT-UK, FI-30-UK, FI-48, FI-48AR, FI-48B, FI-48B-BT-UK, FI-48C, FI-48D, FI-48HY-CLINIC, FI-48W, FI-60DD, FI-80, FI-80AR, FI-80W, FI-E-100, LABP-800 |                 |                     |

|   |   |                 |                                 |
|---|---|-----------------|---------------------------------|
|  |   |                 |                                 |
| <b>GEV No.</b>  | 505069  | <b>Ref. No.</b> | 12024470<br>Z201903             |
| <b>description</b>  | rinse arm boss mounting pos. upper/lower ø 12mm H 22mm L 59mm   |                 |                                 |
| <b>For models:</b>  | AD-120, AD-120B, AD-120BBTDD-UK, AD-120C, AD-120CW, AD-120HY, AD-45BBT, AD-48, AD-48B, AD-48BDD, AD-48C, AD-48D, AD-48DD, AD-48HY, AD-48W, AD-64, AD-64B, AD-64BBT, AD-64BDD, AD-64BTDD, AD-64C, AD-64CW, AD-64D, AD-64DD, AD-64HY, AD-72, AD-72W, AD-90, AD-90BA, AD-90BBT, AD-90BDD, AD-90DD, ADE-120, ADE-120B, CO-110, CO-110B, CO-110BDD, CO-110DD, CO-112, CO-112B, CO-112BDD, CO-112DD, CO-142W, CO-142WDD, CO-170, CO-170B, CO-170BDD, CO-170DD, CO-170HRS, CO-170HRSDD...(Other models you can see in the webshop) |                 |                                 |
| <b>accessories for</b>  | 505069  |                 |                                 |
|  | <b>GEV No.</b>  | 560076          | <b>Ref. No.</b>                 |
|   |   |                 | 12009852<br>12010293<br>Q152024 |
|   | countersunk screw thread M4 L 10mm SS DIN 963/ISO 2009 Qty 20 pcs intake slotted head ø 7.5mm   |                 |                                 |

|   |  |                 |                     |
|---|--|-----------------|---------------------|
|  |  |                 |                     |
| <b>GEV No.</b>  | 505044   | <b>Ref. No.</b> | 12024077<br>Z201905 |
| <b>description</b>  | rinse jet  |                 |                     |
| <b>For models:</b>  | AD-15, AD-15D, AD-90, AD-90BA, AD-90BBT, AD-90BDD, AD-90DD, EASY-500, EASY-500B, EASY-500DD, EASY-500HP, EASY-500HPWBDD, FI-30, FI-30AR, FI-30AR+DD, FI-30B, FI-30B-BT-UK, FI-30-UK, FI-48, FI-48AR, FI-48B, FI-48B-BT-UK, FI-48C, FI-48D, FI-48HY-CLINIC, FI-48W, FI-60DD, FI-80, FI-80AR, FI-80BBT-UK, FI-80W, FI-E-100, LABP-800, LVC-12, LVC-15, LVC-15D, LVC-21, LVC-21B, LVC-21C, LVC-21D, LVC-21W, LVR-10, LVR-14, LVR-20, LVR-20B, MF-21 |                 |                     |
| <b>accessories for</b>  | 505044   |                 |                     |
|  | <b>GEV No.</b>   | 505045          | <b>Ref. No.</b>     |
|   |  |                 | 12009912<br>Q307036 |
|   | O-ring EPDM thickness 1.78mm ID ø 5.28mm Qty 1 pcs   |                 |                     |
|  | <b>GEV No.</b>   | 505046          | <b>Ref. No.</b>     |
|   |  |                 | 12024006<br>Z201906 |
|   | opposite support rinse jet   |                 |                     |

|  |  |                 |                        |
|--|--|-----------------|------------------------|
|  |  |                 |                        |
| <b>GEV No.</b>   | 507537   | <b>Ref. No.</b> | 12007166<br>12Z3119100 |
| <b>description</b>   | rinse arm W 630mm H 645mm nozzles 12   |                 |                        |
| <b>For models:</b>   | ECO-280D, ECO-280I, ECO-370D, ECO-370I, ECO-460D, ECO-460I, ECO-550D, ECO-550I, FI-280D, FI-280I, FI-370D, FI-370I, FI-460D, FI-460I, FI-550D, FI-550I |                 |                        |

|   |  |                 |                     |
|---|--|-----------------|---------------------|
|  |  |                 |                     |
| <b>GEV No.</b>  | 505031   | <b>Ref. No.</b> | 12023710<br>Z400711 |
| <b>description</b>  | opposite support   |                 |                     |
| <b>For models:</b>  | AD-15, AD-15D, AD-20C-UK, AD-21, AD-21B, AD-21BDD, AD-21C, AD-21D, AD-21DD, AD-21W, CO-350, CO-350-B, CO-350-B-DD, CO-350-COLD, CO-350-COLD-B, CO-350-COLD-B-DD, CO-350-COLD-DD, CO-350-DD, CO-352-COLD, CO-352-COLD-B, CO-352-COLD-B-DD, CO-352-COLD-DD, CO-400, CO-400-B, CO-400-B-DD, CO-400-COLD, CO-400-COLD-B, CO-400-COLD-B-DD, CO-400-COLD-DD, CO-400-DD, CO-400-SOFT, CO-402-COLD, CO-402-COLD-B, CO-402-COLD-B-DD, CO-402-COLD-DD, CO-402W, ECO-2700D, ECO-2700I, ECO-280D, ECO-280I, ECO-370D, ECO-370I, ECO-4000D, ECO-4000I, ECO-460D, ECO-460I, ECO-550D, ECO-550I, ECO-6000D, ECO-6000I...(Other models you can see in the webshop) |                 |                     |

|   |   |                 |                     |
|---|---|-----------------|---------------------|
|  |   |                 |                     |
| <b>GEV No.</b>  | 505231  | <b>Ref. No.</b> | 12021106<br>Z791931 |
| <b>description</b>  | rinse jet ø 14mm H 22mm thread M10x0.9                  |                 |                     |
| <b>For models:</b>  | ECO-1600, ECO-2300, ECO-3000, FI-1600, FI-2300, FI-3000 |                 |                     |







Зип-Общепит



vsezip.ru

+7(812)987-08-81



|   |  |                 |                     |
|---|--|-----------------|---------------------|
|  |  |                 |                     |
| 1   |  |                 |                     |
| <b>GEV No.</b>  | 505258   | <b>Ref. No.</b> | 12023568<br>Z311831 |
| <b>description</b>  | wash jet   |                 |                     |
| <b>For models:</b>  | ECO-2700D, ECO-2700I, ECO-280D, ECO-280I, ECO-370D, ECO-370I, ECO-4000D, ECO-4000I, ECO-460D, ECO-460I, ECO-550D, ECO-550I, ECO-6000D, ECO-6000I, FI-2700D, FI-2700I, FI-280D, FI-280I, FI-370D, FI-370I, FI-4000D, FI-4000I, FI-460D, FI-460I, FI-550D, FI-550I, FI-6000D, FI-6000I |                 |                     |

|   |   |                 |                     |
|---|---|-----------------|---------------------|
|  |   |                 |                     |
| 1   |   |                 |                     |
| <b>GEV No.</b>  | 505324  | <b>Ref. No.</b> | 12017004<br>Z100707 |
| <b>description</b>  | end cap for wash arm screw mounting H 13mm WS 42        |                 |                     |
| <b>For models:</b>  | ECO-1600, ECO-2300, ECO-3000, FI-1600, FI-2300, FI-3000 |                 |                     |

|   |   |                 |                     |
|---|---|-----------------|---------------------|
|  |   |                 |                     |
| 1   |   |                 |                     |
| <b>GEV No.</b>  | 505233  | <b>Ref. No.</b> | 12020338<br>Z100706 |
| <b>description</b>  | wash arm with flange L 180mm                            |                 |                     |
| <b>For models:</b>  | ECO-1600, ECO-2300, ECO-3000, FI-1600, FI-2300, FI-3000 |                 |                     |

|   |   |                 |                     |
|---|---|-----------------|---------------------|
|  |   |                 |                     |
| 1   |   |                 |                     |
| <b>GEV No.</b>  | 505319  | <b>Ref. No.</b> | 12020529<br>Z100705 |
| <b>description</b>  | wash arm with flange L 255mm nozzles 3                  |                 |                     |
| <b>For models:</b>  | ECO-1600, ECO-2300, ECO-3000, FI-1600, FI-2300, FI-3000 |                 |                     |
| <b>accessories for</b>  | 505319  |                 |                     |
|  | <b>GEV No.</b>  | 505324          | <b>Ref. No.</b>     |
|   |   |                 | 12017004<br>Z100707 |
|   | end cap for wash arm screw mounting H 13mm WS 42        |                 |                     |
|  | <b>GEV No.</b>  | 510116          | <b>Ref. No.</b>     |
|   |   |                 | 12017168<br>Z100709 |
|   | wash jet mounting pos. upper H 37mm type B hose ø 37mm  |                 |                     |

|   |   |                 |                     |
|---|---|-----------------|---------------------|
|  |   |                 |                     |
| 1   |   |                 |                     |
| <b>GEV No.</b>  | 510116  | <b>Ref. No.</b> | 12017168<br>Z100709 |
| <b>description</b>  | wash jet mounting pos. upper H 37mm type B hose ø 37mm  |                 |                     |
| <b>For models:</b>  | ECO-1600, ECO-2300, ECO-3000, FI-1600, FI-2300, FI-3000 |                 |                     |

|   |  |                 |                     |
|---|--|-----------------|---------------------|
|  |  |                 |                     |
| 1   |  |                 |                     |
| <b>GEV No.</b>  | 505334   | <b>Ref. No.</b> | 12024302<br>Z270721 |
| <b>description</b>  | end cap for wash arm ø 27mm L 33mm suitable for FAGOR  |                 |                     |
| <b>For models:</b>  | ECO-160, ECO-160D, ECO-160I, ECO-200, ECO-200D, ECO-200H, ECO-200HD, ECO-200HI, ECO-200I, FI-160, FI-160AR, FI-160D, FI-160I, FI-200, FI-200AR, FI-200D, FI-200H, FI-200HD, FI-200HI, FI-200I, FI-200W, FI-200WL, FI-200WR |                 |                     |
| <b>accessories for</b>  | 505334   |                 |                     |
|  | <b>GEV No.</b>   | 532499          | <b>Ref. No.</b>     |
|   |  |                 | 12010230<br>Q307062 |
|   | O-ring EPDM thickness 2.62mm ID ø 23.47mm Qty 1 pcs  |                 |                     |

|   |          |                 |                     |
|---|----------|-----------------|---------------------|
|  |          |                 |                     |
| 1   |          |                 |                     |
| <b>GEV No.</b>  | 505215   | <b>Ref. No.</b> | 12017837<br>Z600704 |
| <b>description</b>  | wash jet |                 |                     |

|   |   |                 |                     |
|---|---|-----------------|---------------------|
| <b>wash arm supports</b>  |   |                 |                     |
|  |   |                 |                     |
| 1   |   |                 |                     |
| <b>GEV No.</b>  | 505020  | <b>Ref. No.</b> | 12016686<br>Z400702 |
| <b>description</b>  | opposite support mounting pos. lower              |                 |                     |
| <b>For models:</b>  | LVR-10, LVR-14, LVR-14D, LVR-20, LVR-20B, LVR-20D |                 |                     |

|   |  |                 |                     |
|---|--|-----------------|---------------------|
|  |  |                 |                     |
| 1   |  |                 |                     |
| <b>GEV No.</b>  | 505021   | <b>Ref. No.</b> | 12024312<br>Z710706 |
| <b>description</b>  | opposite support mounting pos. lower   |                 |                     |
| <b>For models:</b>  | AD-120, AD-120B, AD-120BBTDD-UK, AD-120C, AD-120CW, AD-120HY, AD-90, AD-90BA, AD-90BBT, AD-90BDD, AD-90DD, ADE-120, ADE-120B, ECO-120, ECO-120B, FI-100, FI-100AR, FI-100B, FI-100BBT-UK, FI-120, FI-120AR+DD, FI-120B, FI-120C, FI-120HY-CLINIC, FI-120W, FI-80, FI-80AR, FI-80BBT-UK, FI-80W, FI-E-100, LABP-1000, LABP-1200, LABP-800, MF-120 |                 |                     |

Зип Общепит  
vsezip.ru



1

|                    |  |                 |                     |
|--------------------|--|-----------------|---------------------|
| <b>GEV No.</b>     | 505053   | <b>Ref. No.</b> | 12024703<br>Z410702 |
| <b>description</b> | opposite support mounting pos. lower   |                 |                     |
| <b>For models:</b> | AD-15, AD-15D, AD-20C-UK, AD-21, AD-21B, AD-21BDD, AD-21C, AD-21D, AD-21DD, AD-21W, CO-350, CO-350-B, CO-350-B-DD, CO-350-COLD, CO-350-COLD-B, CO-350-COLD-B-DD, CO-350-COLD-DD, CO-350-DD, CO-352-COLD, CO-352-COLD-B, CO-352-COLD-B-DD, CO-352-COLD-DD, CO-400, CO-400-B, CO-400-B-DD, CO-400-COLD, CO-400-COLD-B, CO-400-COLD-B-DD, CO-400-COLD-DD, CO-400-DD, CO-400-SOFT, CO-402-COLD, CO-402-COLD-B, CO-402-COLD-B-DD, CO-402-COLD-DD, CO-402W, LVC-12, LVC-15, LVC-15D, LVC-21, LVC-21B, LVC-21C, LVC-21D, LVC-21W, MF-21 |                 |                     |



1

|                    |  |                 |                     |
|--------------------|--|-----------------|---------------------|
| <b>GEV No.</b>     | 505051   | <b>Ref. No.</b> | 12023613<br>Z200703 |
| <b>description</b> | opposite support mounting pos. lower for wash arm support  |                 |                     |
| <b>For models:</b> | AD-45BBT, AD-48, AD-48B, AD-48BDD, AD-48C, AD-48D, AD-48DD, AD-48HY, AD-48W, AD-64, AD-64B, AD-64BBT, AD-64BDD, AD-64BTDD, AD-64C, AD-64CW, AD-64D, AD-64DD, AD-64HY, AD-72, AD-72W, EASY-500, EASY-500B, EASY-500DD, EASY-500HP, EASY-500HPWBDD, FI-30, FI-30AR, FI-30AR+DD, FI-30B, FI-30B-BT-UK, FI-30-UK, FI-48, FI-48AR, FI-48B, FI-48B-BT-UK, FI-48C, FI-48D, FI-48HY-CLINIC, FI-48W, FI-50, FI-60DD, FI-64, FI-64AR, FI-64B, FI-64B-BT-UK, FI-64C, FI-64D, FI-64HY-CLINIC, FI-64W...(Other models you can see in the webshop) |                 |                     |



1

|                    |   |                 |                     |
|--------------------|---|-----------------|---------------------|
| <b>GEV No.</b>     | 505017  | <b>Ref. No.</b> | 12020347<br>Z400701 |
| <b>description</b> | wash arm support mounting pos. lower              |                 |                     |
| <b>For models:</b> | LVR-10, LVR-14, LVR-14D, LVR-20, LVR-20B, LVR-20D |                 |                     |



1

|                    |  |                 |                                |
|--------------------|--|-----------------|--------------------------------|
| <b>GEV No.</b>     | 505018   | <b>Ref. No.</b> | 12024480<br>Z200701<br>Z210701 |
| <b>description</b> | wash arm support mounting pos. lower   |                 |                                |
| <b>For models:</b> | AD-45BBT, AD-48, AD-48B, AD-48BDD, AD-48C, AD-48D, AD-48DD, AD-48HY, AD-48W, AD-64, AD-64B, AD-64BBT, AD-64BDD, AD-64BTDD, AD-64C, AD-64CW, AD-64D, AD-64DD, AD-64HY, AD-72, AD-72W, EASY-500, EASY-500B, EASY-500DD, EASY-500HP, EASY-500HPWBDD, FI-30, FI-30AR, FI-30AR+DD, FI-30B, FI-30B-BT-UK, FI-30-UK, FI-48, FI-48AR, FI-48B, FI-48B-BT-UK, FI-48C, FI-48D, FI-48HY-CLINIC, FI-48W, FI-50, FI-60DD, FI-64, FI-64AR, FI-64B, FI-64B-BT-UK, FI-64C, FI-64D, FI-64HY-CLINIC, FI-64W...(Other models you can see in the webshop) |                 |                                |



1

|                    |  |                 |  |
|--------------------|--|-----------------|--|
| <b>GEV No.</b>     | 505019   | <b>Ref. No.</b> | 12020989<br>12025170<br>Z740702<br>Z740705 |
| <b>description</b> | wash arm support mounting pos. lower   |                 |  |
| <b>For models:</b> | AD-90, AD-90BA, AD-90BBT, AD-90BDD, AD-90DD, FI-80, FI-80AR, FI-80BBT-UK, FI-80W, FI-E-100, LABP-800 |                 |  |



1

|                    |   |                 |                     |
|--------------------|---|-----------------|---------------------|
| <b>GEV No.</b>     | 505022  | <b>Ref. No.</b> | 12023652<br>Z710704 |
| <b>description</b> | wash arm support mounting pos. lower  |                 |                     |
| <b>For models:</b> | AD-120, AD-120B, AD-120BBTDD-UK, AD-120C, AD-120CW, AD-120HY, ADE-120, ADE-120B, ECO-120, ECO-120B, FI-100, FI-100AR, FI-100B, FI-120, FI-120AR+DD, FI-120B, FI-120C, FI-120HY-CLINIC, FI-120W, FI-E-100, LABP-1200, MF-120 |                 |                     |



1

|                    |   |                 |                     |
|--------------------|---|-----------------|---------------------|
| <b>GEV No.</b>     | 505275  | <b>Ref. No.</b> | 12024478<br>Z710719 |
| <b>description</b> | wash arm support mounting pos. lower D1 ø 47mm H 91mm L1 86mm |                 |                     |
| <b>For models:</b> | FI-100, FI-100AR, FI-100B, FI-100BBT-UK, LABP-1000            |                 |                     |



1

|                    |  |                 |                     |
|--------------------|--|-----------------|---------------------|
| <b>GEV No.</b>     | 505050   | <b>Ref. No.</b> | 12025133<br>Z410701 |
| <b>description</b> | wash arm support mounting pos. lower H 102mm D1 ø 40mm D2 ø 48mm D3 ø 68mm   |                 |                     |
| <b>For models:</b> | AD-15, AD-15D, AD-20C-UK, AD-21, AD-21B, AD-21BDD, AD-21C, AD-21D, AD-21DD, AD-21W, LVC-12, LVC-15, LVC-15D, LVC-21, LVC-21B, LVC-21C, LVC-21D, LVC-21W, MF-21 |                 |                     |



1

|                    |  |                 |                     |
|--------------------|--|-----------------|---------------------|
| <b>GEV No.</b>     | 505056   | <b>Ref. No.</b> | 12023590<br>Z410703 |
| <b>description</b> | wash arm support mounting pos. upper   |                 |                     |
| <b>For models:</b> | AD-15, AD-15D, AD-20C-UK, AD-21, AD-21B, AD-21BDD, AD-21C, AD-21D, AD-21DD, AD-21W, LVC-12, LVC-15, LVC-15D, LVC-21, LVC-21B, LVC-21C, LVC-21D, LVC-21W, MF-21 |                 |                     |





Зип Общепит

vsezip.ru



+7(812)987-08-81

|   |  |                 |                     |
|---|--|-----------------|---------------------|
|  |  |                 |                     |
| 1   |  |                 |                     |
| <b>GEV No.</b>  | 505057   | <b>Ref. No.</b> | 12024471<br>Z200707 |
| <b>description</b>  | wash arm support mounting pos. upper   |                 |                     |
| <b>For models:</b>  | AD-45BBT, AD-48, AD-48B, AD-48BDD, AD-48C, AD-48D, AD-48DD, AD-48HY, AD-48W, AD-64, AD-64B, AD-64BBT, AD-64BDD, AD-64BTDD, AD-64C, AD-64CW, AD-64D, AD-64DD, AD-64HY, AD-72, AD-72W, EASY-500, EASY-500B, EASY-500DD, EASY-500HP, EASY-500HPWBDD, FI-30, FI-30AR, FI-30AR+DD, FI-30B, FI-30B-BT-UK, FI-30-UK, FI-48, FI-48AR, FI-48B, FI-48B-BT-UK, FI-48C, FI-48D, FI-48HY-CLINIC, FI-48W, FI-50, FI-60DD, FI-64, FI-64AR, FI-64B, FI-64B-BT-UK, FI-64C, FI-64D, FI-64HY-CLINIC, FI-64W...(Other models you can see in the webshop) |                 |                     |

|   |                                      |                 |         |
|---|--------------------------------------|-----------------|---------|
|  |                                      |                 |         |
| 1   |                                      |                 |         |
| <b>GEV No.</b>  | 505058                               | <b>Ref. No.</b> | Z200702 |
| <b>description</b>  | wash arm support mounting pos. upper |                 |         |

|   |  |                 |                     |
|---|--|-----------------|---------------------|
|  |  |                 |                     |
| 1   |  |                 |                     |
| <b>GEV No.</b>  | 505059   | <b>Ref. No.</b> | 12024927<br>Z740703 |
| <b>description</b>  | wash arm support mounting pos. upper   |                 |                     |
| <b>For models:</b>  | AD-120BBTDD-UK, AD-90, AD-90BA, AD-90BBT, AD-90BDD, AD-90DD, FI-80, FI-80AR, FI-80BBT-UK, FI-80W, FI-E-100, LABP-800 |                 |                     |

|   |  |                 |                     |
|---|--|-----------------|---------------------|
|  |  |                 |                     |
| 1   |  |                 |                     |
| <b>GEV No.</b>  | 505060   | <b>Ref. No.</b> | 12024934<br>Z710705 |
| <b>description</b>  | wash arm support mounting pos. upper   |                 |                     |
| <b>For models:</b>  | AD-120, AD-120B, AD-120BBTDD-UK, AD-120C, AD-120CW, AD-120HY, AD-90, AD-90BA, AD-90BDD, AD-90DD, ADE-120, ADE-120B, CO-142W, CO-142WDD, COP-174W, COP-174WHRS, ECO-120, ECO-120B, FI-100, FI-100AR, FI-100B, FI-100BBT-UK, FI-120, FI-120AR+DD, FI-120B, FI-120C, FI-120HY-CLINIC, FI-120W, FI-E-100, LABP-1000, LABP-1200, LABP-800, MF-120 |                 |                     |

|   |   |                 |                          |
|---|---|-----------------|--------------------------|
|  |   |                 |                          |
| 1   |   |                 |                          |
| <b>GEV No.</b>  | 501546  | <b>Ref. No.</b> | 12048173                 |
| <b>description</b>  | wash arm support mounting pos. upper ø 42mm H 78mm L1 340mm   |                 |                          |
| <b>For models:</b>  | AD-125, AD-125HRS, AD-125-SOFT, CO-110, CO-110B, CO-110BDD, CO-110DD, CO-112, CO-112B, CO-112BDD, CO-112DD, CO-170, CO-170B, CO-170BDD, CO-170DD, CO-170HRS, CO-170HRSDD, CO-170HRS-SOFT, CO-170-SOFT, CO-172, CO-172B, CO-172BDD, CO-172DD, COP-173, COP-173B, COP-173BDD, COP-173DD, COP-173HRS, COP-173HRSDD, COP-173-SOFT, COP-174, COP-174B, COP-174BDD, COP-174DD, COP-174HRS, COP-174HRSDD |                 |                          |
| <b>accessories for</b>  | 501546  |                 |                          |
|  | <b>GEV No.</b>  | 532103          | <b>Ref. No.</b> 12049214 |
|   | O-ring EPDM thickness 3.53mm ID ø 13.87mm Qty 10 pcs  |                 |                          |

|                        |   |                 |          |
|------------------------|---|-----------------|----------|
| accessories for 501546 |   |                 |          |
| <b>GEV No.</b>         | 699343                                    | <b>Ref. No.</b> | 12048366 |
| <b>description</b>     | gasket L 118mm W 73mm H 9mm thickness 9mm |                 |          |

|   |   |                 |                     |
|---|---|-----------------|---------------------|
|  |   |                 |                     |
| 1   |   |                 |                     |
| <b>GEV No.</b>  | 505047  | <b>Ref. No.</b> | 12025114<br>Z410708 |
| <b>description</b>  | rinse arm shaft   |                 |                     |
| <b>For models:</b>  | AD-15, AD-15D, AD-20C-UK, AD-21, AD-21B, AD-21BDD, AD-21C, AD-21D, AD-21DD, AD-21W, CO-350, CO-350-B, CO-350-B-DD, CO-350-COLD, CO-350-COLD-B, CO-350-COLD-B-DD, CO-350-COLD-DD, CO-350-DD, CO-352-COLD, CO-352-COLD-B, CO-352-COLD-B-DD, CO-352-COLD-DD, CO-400, CO-400-B, CO-400-B-DD, CO-400-COLD, CO-400-COLD-B, CO-400-COLD-B-DD, CO-400-COLD-DD, CO-400-SOFT, CO-402-COLD, CO-402-COLD-B, CO-402-COLD-B-DD, CO-402-COLD-DD, CO-402W, LVC-12, LVC-15, LVC-15D, LVC-21, LVC-21B, LVC-21C, LVC-21D, LVC-21W, MF-21 |                 |                     |

|   |   |                 |                     |
|---|---|-----------------|---------------------|
|  |   |                 |                     |
| 1   |   |                 |                     |
| <b>GEV No.</b>  | 505048  | <b>Ref. No.</b> | 12023844<br>Z200704 |
| <b>description</b>  | rinse arm shaft   |                 |                     |
| <b>For models:</b>  | AD-45BBT, AD-48, AD-48B, AD-48BDD, AD-48C, AD-48D, AD-48DD, AD-48HY, AD-48W, AD-64, AD-64B, AD-64BBT, AD-64BDD, AD-64BTDD, AD-64C, AD-64CW, AD-64D, AD-64DD, AD-64HY, AD-72, AD-72W, AD-90, AD-90BA, AD-90BBT, AD-90BDD, AD-90DD, EASY-500, EASY-500B, EASY-500DD, EASY-500HP, EASY-500HPWBDD, FI-30, FI-30AR, FI-30AR+DD, FI-30B, FI-30B-BT-UK, FI-30-UK, FI-48, FI-48AR, FI-48B, FI-48B-BT-UK, FI-48C, FI-48D, FI-48HY-CLINIC, FI-48W, FI-50, FI-60DD, FI-64, FI-64AR, FI-64B...(Other models you can see in the webshop) |                 |                     |

|   |  |                 |                     |
|---|--|-----------------|---------------------|
|  |  |                 |                     |
| 1   |  |                 |                     |
| <b>GEV No.</b>  | 505049   | <b>Ref. No.</b> | 12023601<br>Z710711 |
| <b>description</b>  | rinse arm shaft  |                 |                     |
| <b>For models:</b>  | AD-120, AD-120B, AD-120BBTDD-UK, AD-120C, AD-120CW, AD-120HY, ADE-120, ADE-120B, ECO-120, ECO-120B, FI-100, FI-100AR, FI-100B, FI-100BBT-UK, FI-120, FI-120AR+DD, FI-120B, FI-120C, FI-120HY-CLINIC, FI-120W, FI-E-100, LABP-1000, LABP-1200, MF-120 |                 |                     |

|   |                 |                 |                      |
|---|-----------------|-----------------|----------------------|
|  |                 |                 |                      |
| 1   |                 |                 |                      |
| <b>GEV No.</b>  | 513122          | <b>Ref. No.</b> | 12029990<br>EU926130 |
| <b>description</b>  | rinse arm shaft |                 |                      |

Зип Общепит

vsezip.ru

+7(812)987-08-81

|   |                           |                 |                     |
|---|---------------------------|-----------------|---------------------|
|  |                           |                 |                     |
| <b>GEV No.</b>  | 505251                    | <b>Ref. No.</b> | 12018232<br>Z680748 |
| <b>description</b>  | rinse arm shaft H 85mm    |                 |                     |
| <b>For models:</b>  | ECO-1200, FI-1200, FI-900 |                 |                     |

|   |  |                 |                     |
|---|--|-----------------|---------------------|
|  |  |                 |                     |
| <b>GEV No.</b>  | 505052   | <b>Ref. No.</b> | 12023801<br>Z410712 |
| <b>description</b>  | rinse arm shaft L1 102mm L2 84mm L3 26mm   |                 |                     |
| <b>For models:</b>  | AD-15, AD-15D, AD-20C-UK, AD-21, AD-21B, AD-21BDD, AD-21C, AD-21D, AD-21DD, AD-21W, CO-350, CO-350-B, CO-350-B-DD, CO-350-COLD, CO-350-COLD-B, CO-350-COLD-B-DD, CO-350-COLD-DD, CO-350-DD, CO-352-COLD, CO-352-COLD-B, CO-352-COLD-B-DD, CO-352-COLD-DD, CO-400, CO-400-B, CO-400-B-DD, CO-400-COLD, CO-400-COLD-B, CO-400-COLD-B-DD, CO-400-COLD-DD, CO-400-DD, CO-400-SOFT, CO-402-COLD, CO-402-COLD-B, CO-402-COLD-B-DD, CO-402-COLD-DD, CO-402W, LVC-12, LVC-15, LVC-15D, LVC-21, LVC-21B, LVC-21C, LVC-21D, LVC-21W, MF-21 |                 |                     |

for washing machine





|   |   |                 |                        |
|---|---|-----------------|------------------------|
|  |   |                 |                        |
| <b>GEV No.</b>  | 698504                                      | <b>Ref. No.</b> | 12026769<br>D000V21001 |
| <b>description</b>  | rack FAGOR center piece for washing machine |                 |                        |

knobs

producer-specific knobs

FAGOR

|   |   |                 |  |
|---|---|-----------------|--|
|  |   |                 |  |
| <b>GEV No.</b>  | 113009  | <b>Ref. No.</b> | 12021151<br>12040067<br>S333005<br>S333006 |
| <b>description</b>  | knob energy regulator 1-9 ø 71mm shaft ø 6x4.6mm shaft flat upper black                                   |                 |  |
| <b>For models:</b>  | CPE7-05, ME7-10BM, ME9-10BM, ME9-10BMS, ME9-15BM, ME9-15BMS, MPE9-10BM, MPE9-10BMS, MPE9-15BM, MPE9-15BMS |                 |  |

|  |   |                 |                     |
|--|---|-----------------|---------------------|
|  |   |                 |                     |
| <b>GEV No.</b>   | 113020  | <b>Ref. No.</b> | 12040255<br>U532130 |
| <b>description</b>   | knob gas tap with ignition flame ø 71mm shaft ø 10x8mm shaft flat right |                 |                     |
| <b>For models:</b>   | CG-200S, CG-210, CG-210G, CG-300S, CG-310, CG-310G                      |                 |                     |

|  |   |                 |                                |
|--|---|-----------------|--------------------------------|
|  |   |                 |                                |
| <b>GEV No.</b>   | 113010  | <b>Ref. No.</b> | 12008927<br>U542100<br>U542101 |
| <b>description</b>   | knob gas tap with ignition flame ø 71mm shaft ø 10x8mm shaft flat right black   |                 |                                |
| <b>For models:</b>   | BG7-05, BG7-05I, BG7-10, BG7-10I, BG9-05, BG9-05I, BG9-10, BG9-10I, CG-1002, CG-1502, CG-2000, CG-2000-2P, CG-2002, CG-2002P, CG-2005, CG-210, CG-210G, CG-300S, CG-310, CG-310G, CG7-10, CG7-11, CG7-20, CG7-40, CG7-41, CG7-61, CG9-10, CG9-11, CG9-20, CG9-40, CG9-41, CG9-51L, CG9-51LC, CG9-51R, CG9-51RC, CG9-60, CG9-61, CG9-82, CGB7-61, CGE7-141, CGE7-41, CGE9-41, CPG7-05, CPG9-05, CPG9-05NC, CPG9-05S, CPG9-05SNC, FTG7-05VL, FTG7-05VR, FTG7-10VL...(Other models you can see in the webshop) |                 |                                |

|  |   |                 |  |
|--|---|-----------------|--|
|  |   |                 |  |
| <b>GEV No.</b>   | 113008  | <b>Ref. No.</b> | 12021150<br>12040256<br>S312102<br>S31211000 |
| <b>description</b>   | knob gas tap with ignition flame ø 71mm shaft ø 10x8mm shaft flat right grey  |                 |  |
| <b>For models:</b>   | BG7-05, BG7-10, BG9-05, BG9-10, CG-200S, CG-210, CG-210G, CG-300S, CG-310, CG-310G, MG7-10, MG7-10BM, MG9-10, MG9-10BM, MG9-10BMS, MG9-10S, MG9-15, MG9-15BM, MG9-15BMS, MG9-15S, MG9-20, MG9-20S, MPG9-10, MPG9-10S, MPG9-15, MPG9-15BM, MPG9-15BMS, MPG9-15S, MPG9-20, MPG9-20S, PL-105L, PL-110L+R |                 |  |

Зип Общепит

vsezip.ru

+7(812)987-08-81



1

|                    |  |                 |                     |
|--------------------|--|-----------------|---------------------|
| <b>GEV No.</b>     | 113038   | <b>Ref. No.</b> | 12007906<br>H122101 |
| <b>description</b> | knob gas tap with ignition flame ø 72mm shaft ø 8x6mm shaft flat right black   |                 |                     |
| <b>For models:</b> | BG6-05I, BG7-05, BG7-05I, BG7-10, BG7-10I, CG7-10, CG7-11, CG7-20, CG7-20H, CG7-30D, CG7-30I, CG7-31D, CG7-31I, CG7-40, CG7-40H, CG7-41, CG7-41H, CG7-50, CG7-51, CG7-60, CG7-60H, CG7-61, CG7-61H, CGB7-61, CGB7-61H, CGB7-61R, CGB7-61RH, CGE7-41, CGE7-41H, CPG7-05, CPG7-05NC, FTG7-05VL, FTG7-05VR, FTG7-10VL, FTG7-10VL+R, FTG7-10VR |                 |                     |

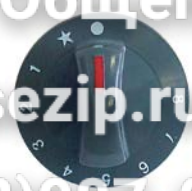

1

|                    |  |                 |  |
|--------------------|--|-----------------|--|
| <b>GEV No.</b>     | 113015   | <b>Ref. No.</b> | 12021132<br>12040259<br>X152110<br>X152111 |
| <b>description</b> | knob gas thermostat 1-8 ø 71mm shaft ø 6x4.6mm shaft flat upper black  |                 |  |
| <b>For models:</b> | SBG7-10, SBG9-10, SBG9-10I, SBG9-10IM, SBG9-10IMS, SBG9-10IS, SBG9-10M, SBG9-10MS, SBG9-10S, SBG9-15IM, SBG9-15IMS |                 |  |



2

|                    |  |                 |                     |
|--------------------|--|-----------------|---------------------|
| <b>GEV No.</b>     | 113040   | <b>Ref. No.</b> | 12008918<br>U912105 |
| <b>description</b> | knob gas thermostat 1-7 ø 71mm shaft ø 8x6.5mm shaft flat right black                                      |                 |                     |
| <b>For models:</b> | CG7-11, CG7-31D, CG7-31I, CG7-41, CG7-41H, CG7-51, CG7-61, CG7-61H, CGB7-61, CGB7-61H, CGB7-61R, CGB7-61RH |                 |                     |



1

|                    |   |                 |                     |
|--------------------|---|-----------------|---------------------|
| <b>GEV No.</b>     | 113016  | <b>Ref. No.</b> | 12040261<br>X162100 |
| <b>description</b> | knob gas thermostat 1-8 ø 71mm shaft ø 6x4.6mm shaft flat upper black |                 |                     |
| <b>For models:</b> | FG-920  |                 |                     |



1

|                    |  |                 |  |
|--------------------|--|-----------------|--|
| <b>GEV No.</b>     | 113019   | <b>Ref. No.</b> | 12008928<br>12040258<br>U842101<br>U842102 |
| <b>description</b> | knob gas thermostat 1-7 ø 71mm shaft ø 8x6.5mm shaft flat right grey   |                 |  |
| <b>For models:</b> | CG-210, CG-210G, CG-310, CG-310G, CG9-51L, CG9-51LC, CG9-51R, CG9-51RC, CGP9-11, FTG7-05L, FTG7-05R, FTG7-10L, FTG7-10L+R, FTG7-10R, FTG9-05L, FTG9-05R, FTG9-10L, FTG9-10L+R, FTG9-10R, FTGC7-05L, FTGC7-10L, FTGC9-05L, FTGC9-05R, FTGC9-10L, FTGC9-10L+R, FTGC9-10R |                 |  |



1

|                    |   |                 |                                |
|--------------------|---|-----------------|--------------------------------|
| <b>GEV No.</b>     | 113001  | <b>Ref. No.</b> | 12021178<br>R202103<br>R202106 |
| <b>description</b> | knob gas thermostat 1-8 ø 71mm shaft ø 8x6.5mm shaft flat right grey  |                 |                                |
| <b>For models:</b> | BMG7-10, BMG9-05, BMG9-10, CG-210, CG-210G, CG-310, CG-310G, CG7-11, CG7-41, CG7-61, CGB7-61, FTG7-05, FTG7-10, FTG9-05L, FTG9-05R, FTG9-05VL, FTG9-05VR, FTG9-10L, FTG9-10L+R, FTG9-10R, FTG9-10VL, FTG9-10VL+R, FTG9-10VR, FTG9-11L, FTG9-11L+R, FTG9-11R, FTGC9-05, FTGC9-05L, FTGC9-05R, FTGC9-10, FTGC9-10L, FTGC9-10L+R, FTGC9-10R, FTGC9-11L, FTGC9-11L+R, FTGC9-11R, PL-105C, PL-110C |                 |                                |



1

|                    |   |                 |         |
|--------------------|---|-----------------|---------|
| <b>GEV No.</b>     | 113018  | <b>Ref. No.</b> | X313002 |
| <b>description</b> | knob gas thermostat 1-8 ø 71mm shaft ø 6x4.6mm shaft flat lower |                 |         |



1

|                    |   |                 |                                |
|--------------------|---|-----------------|--------------------------------|
| <b>GEV No.</b>     | 113013  | <b>Ref. No.</b> | 12021155<br>U673004<br>U673016 |
| <b>description</b> | knob oven TH/TH+BH/BH ø 71mm shaft ø 6x4.6mm shaft flat upper black |                 |                                |
| <b>For models:</b> | CE7-41, CE9-20, CE9-40, CE9-41, CGE7-204, CGE9-41, HE9-10, HE9-20   |                 |                                |

Зип Общепит

vsezip.ru

+7(812)987-08-81



1

|                    |   |                 |  |
|--------------------|---|-----------------|--|
| <b>GEV No.</b>     | 113012  | <b>Ref. No.</b> | 12021136<br>12040069<br>U673003<br>U673015 |
| <b>description</b> | knob switch 7-position ø 71mm shaft ø 6x4.6mm shaft flat upper grey |                 |  |
| <b>For models:</b> | CE7-20, CE7-40, CE7-41, CE9-20, CE9-40, CE9-41                      |                 |  |



1

|                    |  |                 |                                 |
|--------------------|--|-----------------|---------------------------------|
| <b>GEV No.</b>     | 113002   | <b>Ref. No.</b> | 12021133<br>12040260<br>R212100 |
| <b>description</b> | knob thermostat 1-8 ø 71mm shaft ø 6x4.6mm shaft flat upper black              |                 |                                 |
| <b>For models:</b> | BME7-05, BME7-10, BME9-05, BME9-10, FI-120, FI-180, FI-250, ME9-10BM, ME9-15BM |                 |                                 |



1

|                    |  |                 |                     |
|--------------------|--|-----------------|---------------------|
| <b>GEV No.</b>     | 112606   | <b>Ref. No.</b> | 12008048<br>U952101 |
| <b>description</b> | knob switch 7-position ø 72mm shaft ø 6x4.6mm shaft flat upper black long pole |                 |                     |
| <b>For models:</b> | CE6-20, CE6-40, CE6-41, CE7-20, CE7-20Q, CE7-40, CE7-40Q, CE7-41, CE7-41Q      |                 |                     |



1

|                    |   |                 |                     |
|--------------------|---|-----------------|---------------------|
| <b>GEV No.</b>     | 113023  | <b>Ref. No.</b> | 12021135<br>X313003 |
| <b>description</b> | knob thermostat 1-8 with ignition flame ø 71mm shaft ø 6x4.6mm shaft flat lower black |                 |                     |
| <b>For models:</b> | FG-710, FG-720, FG9-05, FG9-05S, FG9-10   |                 |                     |



1

|                    |   |                 |  |
|--------------------|---|-----------------|--|
| <b>GEV No.</b>     | 113017  | <b>Ref. No.</b> | 12021138<br>12040262<br>X183020<br>X183025 |
| <b>description</b> | knob thermostat 1-8 ø 71mm shaft ø 6x4.6mm shaft flat lower black |                 |  |
| <b>For models:</b> | FE-710, FE-720, FE9-05, FE9-05S, FE9-10, FE-920                   |                 |  |



1

|                    |  |                 |          |
|--------------------|--|-----------------|----------|
| <b>GEV No.</b>     | 113048   | <b>Ref. No.</b> | 12046201 |
| <b>description</b> | knob ø 48mm shaft ø 6x4mm black  |                 |          |
| <b>For models:</b> | ACE-061, ACE-101, ACE-102, ACE-201, ACE-202, ACG-061, ACG-101, ACG-102, ACG-201, ACG-202, AE-061, AE-101, APE-061, APE-101 |                 |          |



1

|                    |  |                 |                                |
|--------------------|--|-----------------|--------------------------------|
| <b>GEV No.</b>     | 113014   | <b>Ref. No.</b> | 12021137<br>U673005<br>U673017 |
| <b>description</b> | knob thermostat 1-8 ø 71mm shaft ø 6x4.6mm shaft flat upper  |                 |                                |
| <b>For models:</b> | CE7-41, CE9-41, CGE7-205, CGE9-41, FTE7-05, FTE7-05L, FTE7-05R, FTE7-10, FTE7-10L, FTE7-10L+R, FTE7-10R, FTE9-05L, FTE9-05R, FTE9-10L, FTE9-10L+R, FTE9-10R, FTEC7-05L, FTEC7-10L, FTEC9-05, FTEC9-05L, FTEC9-05R, FTEC9-10, FTEC9-10L, FTEC9-10L+R, FTEC9-10R, HE9-10, HE9-20, SBE7-10, SBE9-10, SBE9-10L, SBE9-10IM, SBE9-10IMS, SBE9-10IS, SBE9-10M, SBE9-10MS, SBE9-10S, SBE9-15IM, SBE9-15IMS |                 |                                |



1

|                    |  |                 |                     |
|--------------------|--|-----------------|---------------------|
| <b>GEV No.</b>     | 505097   | <b>Ref. No.</b> | 12040066<br>Z203008 |
| <b>description</b> | knob switch zero mark ø 34mm shaft ø 6x4.6mm shaft flat lower grey   |                 |                     |
| <b>For models:</b> | ECO-120, ECO-1200, FI-100, FI-1200, FI-80, FI-900, HCG-10-11, HCG-10-21, HCG-2-10-11, HCG-6-11, HME-10-11, HME-10-21, HME-20-11, HME-2-10-11, HME-6-11, HMG-10-11, HMG-10-21, HMG-2-10-11, HMG-6-11, HMM-10-11, HMM-10-21, HMM-20-11, HMM-2-10-11, HMM-6-11, HMP-10-11, HMP-10-21, HMP-20-11, HMP-2-10-11, HMP-6-11, LVC-12, LVC-15, LVC-15D, LVC-21, LVC-21B, LVC-21D, LVC-21W, LVR-10, LVR-14, LVR-14D, LVR-20, LVR-20B, LVR-20D |                 |                     |

Зип Общепит

vsezip.ru

+7(812)987-08-81

|  |   |                 |                     |
|--|---|-----------------|---------------------|
|  <p>1</p> |   |                 |                     |
| <b>GEV No.</b>   | 112293  | <b>Ref. No.</b> | 12024300<br>Z203069 |
| <b>description</b>   | knob switch zero mark ø 39mm shaft ø 6x4.6mm shaft flat lower black   |                 |                     |
| <b>For models:</b>   | ECO-160D, ECO-160I, ECO-200D, ECO-200HD, ECO-200HI, ECO-200I, ECO-280D, ECO-280I, ECO-370D, ECO-370I, ECO-460D, ECO-460I, ECO-550D, ECO-550I, FI-160AR, FI-160D, FI-160I, FI-200AR, FI-200D, FI-200HD, FI-200HI, FI-200I, FI-200WL, FI-200WR, FI-280D, FI-280I, FI-30, FI-30AR, FI-30AR+DD, FI-30B, FI-30B-BT-UK, FI-30-UK, FI-370D, FI-370I, FI-460D, FI-460I, FI-48, FI-48AR, FI-48B, FI-48B-BT-UK, FI-48C, FI-48D, FI-48HY-CLINIC, FI-48W, FI-550D, FI-550I, FI-60DD, FI-64, FI-64AR, FI-64B...(Other models you can see in the webshop) |                 |                     |

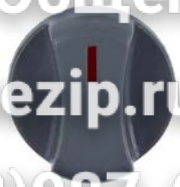
|   |  |                 |                                   |
|---|--|-----------------|-----------------------------------|
|  <p>1</p> |  |                 |                                   |
| <b>GEV No.</b>  | 113021   | <b>Ref. No.</b> | 12018462<br>R663027000<br>R663063 |
| <b>description</b>  | knob switch zero mark ø 39mm shaft ø 6x4.6mm shaft flat lower white  |                 |                                   |
| <b>For models:</b>  | CGE7-41, HCG-10-11, HCG-10-21, HCG-20-11, HCG-20-21, HCG-2-10-11, HCG-2-20-11, HCG-6-11, HEI-10-11, HEI-20-11, HEI-6-11, HEM-10-11, HEM-20-11, HEM-6-11, HEP-10-11, HEP-20-11, HEP-6-11, HGC-10-11, HGC-20-11, HGC-6-11, HGV-10-11, HGV-20-11, HME-10-11, HME-10-21, HME-20-11, HME-20-21, HME-2-10-11, HME-2-20-11, HME-6-11, HMG-10-11, HMG-10-21, HMG-20-11, HMG-2-10-11, HMG-6-11, HMI-10-11, HMI-10-11UL, HMI-10-21, HMI-10-21UL, HMI-2-10-11, HMI-6-11, HMI-6-11UL, HMM-10-11, HMM-10-11UL, HMM-10-21, HMM-10-21UL, HMM-20-11, HMM-20-11UL, HMM-20-21, HMM-2-10-11...(Other models you can see in the webshop) |                 |                                   |

|  |  |                 |                     |
|--|--|-----------------|---------------------|
|  <p>1</p> |  |                 |                     |
| <b>GEV No.</b>   | 112296   | <b>Ref. No.</b> | 12024309<br>Z214902 |
| <b>description</b>   | knob switch zero mark ø 39mm shaft ø 6x4.6mm shaft flat lower black shaft L 19mm   |                 |                     |
| <b>For models:</b>   | ECO-120, ECO-120B, FI-100, FI-100AR, FI-100B, FI-120, FI-120B, FI-120W, FI-30, FI-30AR, FI-30AR+DD, FI-30B, FI-30B-BT-UK, FI-30-UK, FI-48, FI-48AR, FI-48B, FI-48B-BT-UK, FI-48C, FI-48D, FI-48HY-CLINIC, FI-48W, FI-64, FI-64AR, FI-64B, FI-64B-BT-UK, FI-64C, FI-64D, FI-64HY-CLINIC, FI-64W, FI-80, FI-80AR, FI-80BBT-UK, LABP-1000, LABP-1200, LABP-800, LVC-12, LVC-15, LVC-15D, LVC-21, LVC-21B, LVC-21C, LVC-21D, LVC-21W, MF-120, MF-48, MF-64 |                 |                     |

|   |  |                 |          |
|---|--|-----------------|----------|
|  <p>1</p> |  |                 |          |
| <b>GEV No.</b>  | 113043   | <b>Ref. No.</b> | 12044074 |
| <b>description</b>  | knob t.max.°C ø 60mm shaft ø 6mm shaft flat black  |                 |          |
| <b>For models:</b>  | ACE-061, ACE-101, AE-061, AE-061W, AE-101, AE-101W, AE-102, AE-102W, AE-201, AE-202, AG-061, AG-061W, AG-101, AG-101W, AG-102, AG-102W, AG-201, AG-202, APE-061, APE-101 |                 |          |

|  |  |                 |                     |
|--|--|-----------------|---------------------|
|  <p>1</p> |  |                 |                     |
| <b>GEV No.</b>   | 113005   | <b>Ref. No.</b> | 12024317<br>R663062 |
| <b>description</b>   | knob switch zero mark ø 39mm shaft ø 6x4.6mm shaft flat lower white  |                 |                     |
| <b>For models:</b>   | ECO-120, ECO-120B, ECO-160, ECO-160D, ECO-160I, ECO-200, ECO-200D, ECO-200H, ECO-200HD, ECO-200HI, ECO-200I, ECO-2700D, ECO-2700I, ECO-280D, ECO-280I, ECO-370D, ECO-370I, ECO-4000D, ECO-4000I, ECO-460D, ECO-460I, ECO-550D, ECO-550I, ECO-6000D, ECO-6000I, FE-18, FE-25, FE-4, FE-6, FE-8, FI-100, FI-100AR, FI-100B, FI-120, FI-120B, FI-120HY-CLINIC, FI-120W, FI-160, FI-160D, FI-160I, FI-200, FI-200D, FI-200H, FI-200HD, FI-200HI, FI-200I, FI-200W, FI-2700D, FI-2700I, FI-280D...(Other models you can see in the webshop) |                 |                     |

|   |  |                 |                     |
|---|--|-----------------|---------------------|
|  <p>1</p> |  |                 |                     |
| <b>GEV No.</b>  | 113003   | <b>Ref. No.</b> | 12040072<br>R343043 |
| <b>description</b>  | knob zero mark ø 39mm shaft ø 6x4.6mm shaft flat lower   |                 |                     |
| <b>For models:</b>  | FE-18, FE-25, FE-4, FE-6, FE-8, FI-300B, HCV-10-11, HCV-10-21, HCV-2-10-21, HCV-5-11, HE-10-11, HE-10-21, HE-2-10-11, HE-5-11, HE-6-11, HG-10-11, HG-10-21, HG-2-10-11 |                 |                     |

Зип Общежит

vsezip.ru

+7(812)987-08-81



1

|                    |  |                 |                        |
|--------------------|--|-----------------|------------------------|
| <b>GEV No.</b>     | 113042   | <b>Ref. No.</b> | 12009885<br>Z513024000 |
| <b>description</b> | knob zero mark t.max.°C ø 50mm shaft ø 6x4.6mm shaft flat lower black  |                 |                        |
| <b>For models:</b> | ECO-160D, ECO-160I, ECO-200D, ECO-200HD, ECO-200HI, ECO-200I, ECO-2700D, ECO-2700I, ECO-280D, ECO-280I, ECO-370D, ECO-370I, ECO-4000D, ECO-4000I, ECO-460D, ECO-460I, ECO-550D, ECO-550I, ECO-6000D, ECO-6000I, FI-160AR, FI-160D, FI-160I, FI-200AR, FI-200D, FI-200HD, FI-200HI, FI-200I, FI-200WL, FI-200WR, FI-2700D, FI-2700I, FI-280D, FI-280I, FI-370D, FI-370I, FI-4000D, FI-4000I, FI-460D, FI-460I, FI-550D, FI-550I, FI-6000D, FI-6000I |                 |                        |



1

|                    |  |                 |                        |
|--------------------|--|-----------------|------------------------|
| <b>GEV No.</b>     | 113046   | <b>Ref. No.</b> | 12007854<br>R042102000 |
| <b>description</b> | knob gas tap ø 75mm shaft ø 8x6mm black/silver   |                 |                        |
| <b>For models:</b> | CG9-51L, CG9-51LC, CG9-51R, CG9-51RC, CGP9-11, FTG9-05L, FTG9-05L-AD, FTG9-05PLUS-CL, FTG9-05PLUS-CR, FTG9-05PLUS-L, FTG9-05PLUS-R, FTG9-05R, FTG9-05R-AD, FTG9-05VL, FTG9-05VR, FTG9-10L, FTG9-10L+R, FTG9-10L+R-AD, FTG9-10L-AD, FTG9-10PLUS-CL, FTG9-10PLUS-CLR, FTG9-10PLUS-CR, FTG9-10PLUS-L, FTG9-10PLUS-LR, FTG9-10PLUS-R, FTG9-10R, FTG9-10R-AD, FTG9-10VL, FTG9-10VL+R, FTG9-10VR, FTG9-11L, FTG9-11L+R, FTG9-11R, FTGC9-05L, FTGC9-05L-AD, FTGC9-05R, FTGC9-05R-AD, FTGC9-10L, FTGC9-10L+R, FTGC9-10L+R-AD, FTGC9-10L-AD, FTGC9-10R, FTGC9-10R-AD, FTGC9-11L, FTGC9-11L+R, FTGC9-11R |                 |                        |



1

|                    |   |                 |                     |
|--------------------|---|-----------------|---------------------|
| <b>GEV No.</b>     | 550438  | <b>Ref. No.</b> | 12039850<br>Z603052 |
| <b>description</b> | indicator for knob  |                 |                     |
| <b>For models:</b> | FE-18, FE-25, FE-4, FE-6, FE-8, FI-300B, FI-300R, FI-650R, HCV-10-11, HCV-10-21, HCV-2-10-21, HCV-5-11, HE-10-11, HE-10-21, HE-2-10-11, HE-5-11, HE-6-11, HG-10-11, HG-10-21, HG-2-10-11, LC-10, LC-14, LC-7, LC-7A |                 |                     |



1

|                    |   |                 |                     |
|--------------------|---|-----------------|---------------------|
| <b>GEV No.</b>     | 113039  | <b>Ref. No.</b> | 12020425<br>U022105 |
| <b>description</b> | knob gas tap with ignition flame ø 74mm shaft ø 10x8mm shaft flat right black   |                 |                     |
| <b>For models:</b> | BG9-05, BG9-05I, BG9-10, BG9-10I, CG9-10, CG9-11, CG9-20, CG9-40, CG9-41, CG9-51L, CG9-51LC, CG9-51R, CG9-51RC, CG9-60, CG9-61, CG9-82, CGE9-41, CGF9-120D, CGF9-120I, CGF9-121D, CGF9-121I, CPG9-05, CPG9-05S, FTG9-05VL, FTG9-05VR, FTG9-10VL, FTG9-10VL+R, FTG9-10VR |                 |                     |



1

|                    |  |                 |                     |
|--------------------|--|-----------------|---------------------|
| <b>GEV No.</b>     | 113000   | <b>Ref. No.</b> | 12018461<br>T303010 |
| <b>description</b> | knob switch zero mark ø 50mm shaft ø 5.5x4mm shaft flat lower grey                     |                 |                     |
| <b>For models:</b> | HEI-10-21, HEI-20-21, HEM-10-21, HEM-20-21, HGC-10-21, HGC-20-21, HGV-10-21, HGV-20-21 |                 |                     |



1

|                    |  |                 |                                   |
|--------------------|--|-----------------|-----------------------------------|
| <b>GEV No.</b>     | 113044   | <b>Ref. No.</b> | 12009005<br>U022117<br>U022117000 |
| <b>description</b> | knob gas tap with ignition flame t.max.°C ø 75mm shaft ø 8x6mm black/silver  |                 |                                   |
| <b>For models:</b> | BG9-05AD, BG9-05PF, BG9-05PI, BG9-05PLUS-I, BG9-10AD, BG9-10PF, BG9-10PI, BG9-10PLUS-I, CG9-05AD, CG9-05PLUS, CG9-10, CG9-10AD, CG9-10PLUS, CG9-11, CG9-11AD, CG9-11PLUS, CG9-20, CG9-20AD, CG9-20AD-H, CG9-20H, CG9-20PLUS, CG9-20PLUS-H, CG9-31PLUS-D, CG9-31PLUS-I, CG9-40, CG9-40AD, CG9-40AD-H, CG9-40H, CG9-40PLUS, CG9-40PLUS-H, CG9-41, CG9-41AD, CG9-41AD-H, CG9-41H, CG9-41PLUS, CG9-41PLUS-H, CG9-51L, CG9-51LC, CG9-51R, CG9-51RC, CG9-60, CG9-60AD, CG9-60AD-H, CG9-60H, CG9-60PLUS, CG9-60PLUS-H, CG9-61, CG9-61AD, CG9-61AD-H, CG9-61H... (Other models you can see in the webshop) |                 |                                   |



1

|                    |  |                 |                     |
|--------------------|--|-----------------|---------------------|
| <b>GEV No.</b>     | 113006   | <b>Ref. No.</b> | 12018553<br>T303011 |
| <b>description</b> | knob t.max.°C ø 50mm shaft ø 6x5mm shaft flat vertical grey  |                 |                     |
| <b>For models:</b> | HEI-10-21, HEI-20-21, HEM-10-21, HEM-20-21, HEP-10-21, HEP-20-21, HGC-10-21, HGC-20-21, HGP-10-21, HGP-20-21, HGV-10-21, HGV-20-21 |                 |                     |





1

|                    |   |                 |                        |
|--------------------|---|-----------------|------------------------|
| <b>GEV No.</b>     | 112813  | <b>Ref. No.</b> | 12009011<br>X022133000 |
| <b>description</b> | knob zero mark ø 75mm shaft ø 6x4.6mm shaft flat upper silver/black   |                 |                        |
| <b>For models:</b> | CPE9-05, CPE9-05NC, CPE9-05S, CPE9-05SNC, CPG9-05, CPG9-05NC, CPG9-05S, CPG9-05SNC, MV9-10BM, MV9-15BM, SBE9-10, SBE9-10I, SBE9-10IM, SBE9-10IMS, SBE9-10IS, SBE9-10M, SBE9-10MS, SBE9-10S, SBE9-15IM, SBE9-15IMS, SBE9-15M, SBE9-15MS, SBG9-10, SBG9-10I, SBG9-10IM, SBG9-10IMS, SBG9-10IS, SBG9-10M, SBG9-10MS, SBG9-10S, SBG9-15IM, SBG9-15IMS |                 |                        |



1

|                    |   |                 |                     |
|--------------------|---|-----------------|---------------------|
| <b>GEV No.</b>     | 691074  | <b>Ref. No.</b> | 12024516<br>R663046 |
| <b>description</b> | gasket switch shaft   |                 |                     |
| <b>For models:</b> | CO-350, CO-350-B, CO-350-B-DD, CO-350-COLD, CO-350-COLD-B, CO-350-COLD-B-DD, CO-350-COLD-DD, CO-350-DD, CO-400, CO-400-B, CO-400-B-DD, CO-400-COLD, CO-400-COLD-B, CO-400-COLD-B-DD, CO-400-COLD-DD, CO-400-DD, CO-400-SOFT, CO-500, CO-500B, CO-500BDD, CO-500DD, CO-501, CO-501B, CO-501BDD, CO-501DD, CO-501-SOFT, COP-503, COP-503B, COP-503BDD, COP-503DD, COP-503-SOFT, COP-504, COP-504B, COP-504BDD, COP-504DD, ECO-2700D, ECO-2700I, ECO-4000D, ECO-4000I, ECO-6000D, ECO-6000I, FI-200W, FI-2700D, FI-2700I, FI-4000D, FI-4000I, FI-6000D, FI-6000I, HCG-10-11, HCG-10-21...(Other models you can see in the webshop) |                 |                     |

steam/water taps

steam/water taps



1

|                    |  |                 |                     |
|--------------------|--|-----------------|---------------------|
| <b>GEV No.</b>     | 505322   | <b>Ref. No.</b> | 12009121<br>S102110 |
| <b>description</b> | knob ø 55mm L 49mm shaft 7.5x7.5mm   |                 |                     |
| <b>For models:</b> | ME9-10BM, ME9-10BMS, ME9-15BM, ME9-15BM316, ME9-15BMS, MG9-10, MG9-10BM, MG9-10BMS, MG9-10S, MG9-15, MG9-15BM, MG9-15BM316, MG9-15BMS, MG9-15S, MG9-20, MG9-20S, MPE9-10BM, MPE9-10BMS, MPE9-15BM, MPE9-15BMS, MPG9-10, MPG9-10BM, MPG9-10BMS, MPG9-10S, MPG9-15, MPG9-15BM, MPG9-15BMS, MPG9-15S, MPG9-20, MPG9-20S |                 |                     |

miscellaneous



1

|                    |  |                 |                     |
|--------------------|--|-----------------|---------------------|
| <b>GEV No.</b>     | 691075   | <b>Ref. No.</b> | 12018344<br>R662810 |
| <b>description</b> | disc for knob ID ø 10mm ED ø 25mm H 1mm  |                 |                     |
| <b>For models:</b> | HCG-10-11, HCG-10-21, HCG-20-11, HCG-20-21, HCG-2-10-11, HCG-2-20-11, HCG-6-11, HEI-10-11, HEI-20-11, HEI-6-11, HEM-10-11, HEM-20-11, HEM-6-11, HEP-10-11, HEP-20-11, HEP-6-11, HGC-10-11, HGC-20-11, HGC-6-11, HGV-10-11, HGV-20-11, HME-10-11, HME-10-21, HME-20-11, HME-2-10-11, HME-2-20-11, HME-6-11, HMG-10-11, HMG-10-11UL, HMG-10-21, HMG-10-21UL, HMG-20-11, HMG-2-10-11, HMG-6-11, HMI-10-11, HMI-10-11UL, HMI-10-21, HMI-10-21UL, HMI-2-10-11, HMI-6-11, HMI-6-11UL, HMM-10-11, HMM-10-11UL, HMM-10-21, HMM-10-21UL, HMM-20-11, HMM-20-11UL, HMM-20-21, HMM-20-21UL...(Other models you can see in the webshop) |                 |                     |

accessories

gaskets



1

|                    |  |                 |                     |
|--------------------|--|-----------------|---------------------|
| <b>GEV No.</b>     | 691076   | <b>Ref. No.</b> | 12020848<br>R663045 |
| <b>description</b> | gasket   |                 |                     |
| <b>For models:</b> | HCG-10-11, HCG-10-21, HCG-20-11, HCG-20-21, HCG-2-10-11, HCG-2-20-11, HCG-6-11, HEI-10-11, HEI-20-11, HEI-6-11, HEM-10-11, HEM-20-11, HEM-6-11, HEP-10-11, HEP-20-11, HEP-6-11, HGC-10-11, HGC-20-11, HGC-6-11, HGV-10-11, HGV-20-11, HME-10-11, HME-10-21, HME-20-11, HME-2-10-11, HME-2-20-11, HME-6-11, HMG-10-11, HMG-10-11UL, HMG-10-21, HMG-10-21UL, HMG-20-11, HMG-2-10-11, HMG-6-11, HMI-10-11, HMI-10-11UL, HMI-10-21, HMI-10-21UL, HMI-2-10-11, HMI-6-11, HMI-6-11UL, HMM-10-11, HMM-10-11UL, HMM-10-21, HMM-10-21UL, HMM-20-11, HMM-20-11UL, HMM-20-21, HMM-20-21UL...(Other models you can see in the webshop) |                 |                     |



1

|                    |  |                 |                     |
|--------------------|--|-----------------|---------------------|
| <b>GEV No.</b>     | 113004   | <b>Ref. No.</b> | 12018348<br>R662809 |
| <b>description</b> | spacer ring  |                 |                     |
| <b>For models:</b> | HCG-10-11, HCG-10-21, HCG-20-11, HCG-20-21, HCG-2-10-11, HCG-2-20-11, HCG-6-11, HEI-10-11, HEI-20-11, HEI-6-11, HEM-10-11, HEM-20-11, HEM-6-11, HEP-10-11, HEP-20-11, HEP-6-11, HGC-10-11, HGC-20-11, HGC-6-11, HGV-10-11, HGV-20-11, HME-10-11, HME-10-21, HME-20-11, HME-2-10-11, HME-2-20-11, HME-6-11, HMG-10-11, HMG-10-11UL, HMG-10-21, HMG-10-21UL, HMG-20-11, HMG-2-10-11, HMG-6-11, HMI-10-11, HMI-10-11UL, HMI-10-21, HMI-10-21UL, HMI-2-10-11, HMI-6-11, HMI-6-11UL, HMM-10-11, HMM-10-11UL, HMM-10-21, HMM-10-21UL, HMM-20-11, HMM-20-11UL, HMM-20-21, HMM-20-21UL...(Other models you can see in the webshop) |                 |                     |



handles and hand wheels

Зип-Общепит  
vsezip.ru  
+7(812)987-08-81

hand wheels

hand wheels



|   |  |                 |  |
|---|--|-----------------|--|
| <b>GEV No.</b>  | 690086   | <b>Ref. No.</b> | 12009585<br>X156117<br>X156139                 |
| <b>description</b>  | hand wheel ø 200mm D1 ø 48mm bore ø 20mm thread M8 hole distance 9mm groove widthmm L1 30mm L2 60mm handle length 82mm with folding handle   |                 |  |
| <b>For models:</b>  | SBE7-10, SBE9-10, SBE9-10I, SBE9-10I-AD, SBE9-10I-AD-S, SBE9-10IM, SBE9-10IMS, SBE9-10IS, SBE9-10PLUS-I, SBE9-10PLUS-SI, SBE9-10S, SBE9-10USMC, SBG7-10, SBG9-10, SBG9-10I, SBG9-10I-AD, SBG9-10I-AD-S, SBG9-10IS, SBG9-10PLUS-I, SBG9-10PLUS-SI, SBG9-10S |                 |  |
| <b>spare parts for</b>  | 690086   |                 |  |
|    | <b>GEV No.</b>   | 514255          | <b>Ref. No.</b> —                              |
|   | folding handle ø 26mm total length 85mm seat ø 20mm shaft ømm thread M6 with pin L 85mm  |                 |  |
| <b>accessories for</b>  | 690086   |                 |  |
|  | <b>GEV No.</b>   | 560175          | <b>Ref. No.</b> 12010091<br>Q131504<br>Q131552 |
|   | grub screw thread M8 L 16mm DIN 914/ISO 4027 intake internal hexagon WS 4 Qty 1 pcs  |                 |  |

spare parts and accessories



|                    |   |                 |                     |
|--------------------|---|-----------------|---------------------|
| <b>GEV No.</b>     | 691037  | <b>Ref. No.</b> | 12009478<br>X156135 |
| <b>description</b> | folding handle ø 26mm total length 100mm seat ø 20mm thread M6 with pin                                       |                 |                     |
| <b>For models:</b> | SBE7-10, SBE9-10, SBE9-10I, SBE9-10IS, SBE9-10S, SBE9-10USMC, SBG7-10, SBG9-10, SBG9-10I, SBG9-10IS, SBG9-10S |                 |                     |



|                    |   |                 |                                   |
|--------------------|---|-----------------|-----------------------------------|
| <b>GEV No.</b>     | 514523  | <b>Ref. No.</b> | 12008845<br>X156161<br>X156161000 |
| <b>description</b> | spindle for hand wheel L 280mm for tilting bratt pan  |                 |                                   |
| <b>For models:</b> | SBE7-10, SBE9-10, SBE9-10I, SBE9-10I-AD, SBE9-10I-AD-S, SBE9-10IM, SBE9-10IMS, SBE9-10IS, SBE9-10PLUS-I, SBE9-10PLUS-SI, SBE9-10S, SBG7-10, SBG9-10, SBG9-10I, SBG9-10I-AD, SBG9-10I-AD-S, SBG9-10IS, SBG9-10PLUS-I, SBG9-10PLUS-SI, SBG9-10S |                 |                                   |

fixed

cylindrical handles

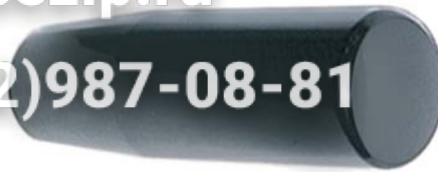

|                    |  |                 |                                |
|--------------------|--|-----------------|--------------------------------|
| <b>GEV No.</b>     | 110703   | <b>Ref. No.</b> | 12020819<br>T055434<br>T055440 |
| <b>description</b> | cylindrical handle thread M10 ø 28mm L 87mm      |                 |                                |
| <b>For models:</b> | BG7-05, BG7-10, BG9-05, BG9-05I, BG9-10, BG9-10I |                 |                                |

cone handles



|                    |   |                 |                     |
|--------------------|---|-----------------|---------------------|
| <b>GEV No.</b>     | 111464  | <b>Ref. No.</b> | 12021169<br>Z102105 |
| <b>description</b> | cone handle thread M10 ø 26mm L 42mm plastic black      |                 |                     |
| <b>For models:</b> | ECO-1600, ECO-2300, ECO-3000, FI-1600, FI-2300, FI-3000 |                 |                     |



|                    |  |                 |                     |
|--------------------|--|-----------------|---------------------|
| <b>GEV No.</b>     | 111129   | <b>Ref. No.</b> | 12008060<br>S116122 |
| <b>description</b> | cone handle thread M10 ø 34mm L 55mm plastic black   |                 |                     |
| <b>For models:</b> | CG9-51LC, CG9-51RC, FTE7-05, FTE7-05L, FTE7-05R, FTE7-10, FTE7-10L, FTE7-10L+R, FTE7-10R, FTE9-05L, FTE9-05R, FTE9-10L, FTE9-10L+R, FTE9-10R, FTEC7-05L, FTEC7-10L, FTEC9-05, FTEC9-05L, FTEC9-05R, FTEC9-05USMC, FTEC9-10, FTEC9-10L, FTEC9-10L+R, FTEC9-10R, FTEC9-10USMC, FTG7-05, FTG7-05L, FTG7-05R, FTG7-10, FTG7-10L, FTG7-10L+R, FTG7-10R, FTG9-05L, FTG9-05R, FTG9-05VL, FTG9-05VR, FTG9-10L, FTG9-10L+R, FTG9-10R, FTG9-10VL, FTG9-10VL+R, FTG9-10VR, FTGC7-05L, FTGC7-10L, FTGC9-05, FTGC9-05L, FTGC9-05R, FTGC9-10, FTGC9-10L, FTGC9-10L+R...(Other models you can see in the webshop) |                 |                     |

handle bars

consoles



|                    |   |                 |                        |
|--------------------|---|-----------------|------------------------|
| <b>GEV No.</b>     | 694208  | <b>Ref. No.</b> | 12037118<br>6003010094 |
| <b>description</b> | console for handle rod tube ø 25mm H 47mm plastic |                 |                        |



handle rails

FAGOR



|                    |   |                 |                                 |
|--------------------|---|-----------------|---------------------------------|
| <b>GEV No.</b>     | 507538  | <b>Ref. No.</b> | 12009630<br>12019260<br>Z450502 |
| <b>description</b> | handle rail L 505mm W 29mm H 35mm hole distance 277mm Qty 1 pcs |                 |                                 |
| <b>For models:</b> | AD-20C-UK, AD-21C   |                 |                                 |

bracket handles



Image not available

|                    |             |                 |                     |
|--------------------|-------------|-----------------|---------------------|
| <b>GEV No.</b>     | 505003      | <b>Ref. No.</b> | 12014635<br>Z650531 |
| <b>description</b> | pull handle |                 |                     |



|                    |   |                 |                     |
|--------------------|---|-----------------|---------------------|
| <b>GEV No.</b>     | 505001  | <b>Ref. No.</b> | 12016135<br>U580521 |
| <b>description</b> | pull handle L 182mm H 42mm mounting distance 170mm thread M6 W 36mm   |                 |                     |
| <b>For models:</b> | CG-310, CG-310G, CG7-61, CG9-51L, CG9-51LC, CG9-51R, CG9-51RC, CG9-61, CGB7-61, CPG7-05, ECO-280D, ECO-280I, ECO-370D, ECO-370I, ECO-460D, ECO-460I, ECO-550D, ECO-550I, EN9-05C, EN9-10C, FE-710, FE-720, FE9-05, FE9-05S, FE9-10, FE-920, FG-710, FG-720, FG9-05, FG9-05S, FG9-10, FG-920, FG-940, FI-280D, FI-280I, FI-370D, FI-370I, FI-460D, FI-460I, FI-550D, FI-550I, LVC-12, LVC-15, LVC-15D, LVC-21, LVC-21B, LVC-21D, LVC-21W, LVR-10, LVR-14...(Other models you can see in the webshop) |                 |                     |



|                    |  |                 |                     |
|--------------------|--|-----------------|---------------------|
| <b>GEV No.</b>     | 691681   | <b>Ref. No.</b> | 12024991<br>Z400540 |
| <b>description</b> | pull handle L 205mm mounting distance 170mm ø 30mm handle M5   |                 |                     |
| <b>For models:</b> | CG9-51L, CG9-51LC, CG9-51R, CG9-51RC, CG9-61, CPG9-11, CPG9-05, CPG9-05NC, CPG9-05S, CPG9-05SNC, ECO-2700D, ECO-2700I, ECO-280D, ECO-280I, ECO-370D, ECO-370I, ECO-4000D, ECO-4000I, ECO-460D, ECO-460I, ECO-550D, ECO-550I, ECO-6000D, ECO-6000I, EN9-05C, EN9-10C, FE9-05, FE9-05S, FE9-05USMC, FE9-10, FG9-05, FG9-05S, FG9-10, FI-2700D, FI-2700I, FI-280D, FI-280I, FI-370D, FI-370I, FI-4000D, FI-4000I, FI-460D, FI-460I, FI-550D, FI-550I, FI-6000D, FI-6000I, MB9-05-PUERTA-DCHA, MB9-05-PUERTA-IZDA, MB9-10-PUERTA-DOBLE...(Other models you can see in the webshop) |                 |                     |

Зип Общепит

vsezip.ru

+7(812)987-08-81

|                    |   |                 |                     |
|--------------------|---|-----------------|---------------------|
| <b>GEV No.</b>     | 691687  | <b>Ref. No.</b> | 12009199<br>S036123 |
| <b>description</b> | pull handle L 220mm H 60mm mounting distance 200mm W 140mm handle M10   |                 |                     |
| <b>For models:</b> | ME9-10BM, ME9-10BMS, ME9-15BM, ME9-15BM316, ME9-15BMS, MG9-10, MG9-10BM, MG9-10BMS, MG9-10S, MG9-15, MG9-15BM, MG9-15BMS, MG9-15S, MG9-20, MG9-20S, MPE9-10BM, MPE9-10BMS, MPE9-15BM, MPE9-15BMS, MPG9-10, MPG9-10BM, MPG9-10BMS, MPG9-10S, MPG9-15, MPG9-15BM, MPG9-15BMS, MPG9-15S, MPG9-20, MPG9-20S, MV9-10BM, MV9-15BM, SBE7-10, SBE9-10, SBE9-10I, SBE9-10IM, SBE9-10IMS, SBE9-10IS, SBE9-10M, SBE9-10MS, SBE9-10S, SBE9-10USMC, SBE9-15IM, SBE9-15IMS, SBE9-15M, SBE9-15MS, SBE9-10, SBE9-10I, SBE9-10IM, SBE9-10IMS...(Other models you can see in the webshop) |                 |                     |



|                    |  |                 |                     |
|--------------------|--|-----------------|---------------------|
| <b>GEV No.</b>     | 505002   | <b>Ref. No.</b> | 12010961<br>Z200512 |
| <b>description</b> | pull handle L 272mm H 42mm mounting distance 260mm thread M6 W 36mm  |                 |                     |
| <b>For models:</b> | ECO-120, ECO-120B, ECO-160D, ECO-160I, ECO-200D, ECO-200I, ECO-280D, ECO-280I, ECO-3000, ECO-370D, ECO-370I, ECO-460D, ECO-460I, ECO-550D, ECO-550I, FI-100, FI-100AR, FI-100B, FI-100BBT-UK, FI-120, FI-120AR+DD, FI-120B, FI-120C, FI-120HY-CLINIC, FI-120W, FI-160D, FI-160I, FI-200D, FI-200I, FI-280D, FI-280I, FI-30, FI-3000, FI-370D, FI-370I, FI-460D, FI-460I, FI-48, FI-48B, FI-48W, FI-50, FI-550D, FI-550I, FI-64, FI-64B, FI-64W, FI-72, FI-80, FI-80AR, FI-80BBT-UK...(Other models you can see in the webshop) |                 |                     |



|                    |  |                 |                     |
|--------------------|--|-----------------|---------------------|
| <b>GEV No.</b>     | 505316   | <b>Ref. No.</b> | 12024005<br>Z200550 |
| <b>description</b> | pull handle L 293mm H 65mm mounting distance 260mm thread M6 W 36mm  |                 |                     |
| <b>For models:</b> | ECO-160, ECO-160D, ECO-160I, ECO-200, ECO-200D, ECO-200H, ECO-200HD, ECO-200HI, ECO-200I, ECO-2700D, ECO-2700I, ECO-280D, ECO-280I, ECO-370D, ECO-370I, ECO-4000D, ECO-4000I, ECO-460D, ECO-460I, ECO-550D, ECO-550I, ECO-6000D, ECO-6000I, FI-100, FI-100AR, FI-100B, FI-100BBT-UK, FI-160, FI-160AR, FI-160D, FI-160I, FI-200, FI-200AR, FI-200D, FI-200H, FI-200HD, FI-200HI, FI-200I, FI-200W, FI-200WL, FI-200WR, FI-2700D, FI-2700I, FI-280D, FI-280I, FI-370D, FI-370I, FI-4000D, FI-4000I, FI-460D...(Other models you can see in the webshop) |                 |                     |

Зип.Общепит

LOCKS

locking devices  
producer-specific

FAGOR

+7(812)987-08-81

1

|                    |                     |                 |                        |
|--------------------|---------------------|-----------------|------------------------|
| <b>GEV No.</b>     | 691856              | <b>Ref. No.</b> | 12030475<br>A169150001 |
| <b>description</b> | key cylinder ø 22mm |                 |                        |

electromagnetic closer

1

|                    |   |                 |  |
|--------------------|---|-----------------|--|
| <b>GEV No.</b>     | 692613  | <b>Ref. No.</b> | 12003922<br>12038364<br>12038446<br>12127838<br>12154822<br>13P6205160 |
| <b>description</b> | electromagnetic closer L 220mm W 100mm H 50mm |                 |  |

**For models:** LA-25M, LA-AC-10M, LA-AC-10MA, LA-AC-10MP, LA-AC-13M, LA-AC-13MA, LA-AC-13MP, LA-AC-18M, LA-AC-18MA, LA-AC-18MP, LA-AC-25M, LA-AC-25MA, LA-AC-25MP, LA-E-10M, LA-E-10MA, LA-E-10MP, LA-E-13M, LA-E-13MA, LA-E-13MP, LA-E-18M, LA-E-18MA, LA-E-18MP, LA-E-25M, LA-E-25MA, LA-E-25MP, LA-V-10M, LA-V-10MP, LA-V-13M, LA-V-13MP, LA-V-18M, LA-V-18MP, LA-V-25M, LA-V-25MP, LB-A-10M, LB-E-10M, LB-V-10M, LF-13MPP, LF-18MPP, LF-8MPP, LR-AC-10M, LR-AC-10MA, LR-AC-10MP, LR-AC-13M, LR-AC-13MA, LR-AC-13MP, LR-AC-18M, LR-AC-18MA, LR-AC-18MP, LR-AC-25M, LR-AC-25MA...(Other models you can see in the webshop)

handle latches

producer-specific

FAGOR

1

|                    |   |                 |                                    |
|--------------------|---|-----------------|------------------------------------|
| <b>GEV No.</b>     | 693576  | <b>Ref. No.</b> | 12029692<br>RT2400176<br>RT2402762 |
| <b>description</b> | catch L 83mm ø 41mm clamp length 43mm BL 45mm |                 |                                    |

**spare parts for** 693576

|                |        |                 |   |
|----------------|--------|-----------------|---|
| <b>GEV No.</b> | 693577 | <b>Ref. No.</b> | 12031725<br>12038017<br>RT2400506<br>RT2401100<br>RT2402761 |
|----------------|--------|-----------------|---|

D-lock W 29mm H 17mm spring length 50mm spring thickness 3mm



|                    |   |                 |                     |
|--------------------|---|-----------------|---------------------|
| <b>GEV No.</b>     | 691679  | <b>Ref. No.</b> | 12024557<br>Z400542 |
| <b>description</b> | pull handle L 310mm H 32mm mounting distance 260mm dishwasher since 2007 handle M6  |                 |                     |
| <b>For models:</b> | ATM-031ECO, CE6-41, CG-310, CG-310G, CG6-41, CGE6-41, FI-100, FI-100AR, FI-100B, FI-100BBT-UK, FI-80, FI-80AR, FI-80BBT-UK, FI-80W, FI-E-100, LVC-12, LVC-15, LVC-15D, LVC-21, LVC-21B, LVC-21C, LVC-21D, LVC-21W |                 |                     |



|                    |   |                 |                     |
|--------------------|---|-----------------|---------------------|
| <b>GEV No.</b>     | 691678  | <b>Ref. No.</b> | 12018087<br>U560501 |
| <b>description</b> | pull handle L 615mm H 55mm mounting distance 580mm ø 30mm handle M5   |                 |                     |
| <b>For models:</b> | CE9-41, CG-1002, CG-1502, CG-2002, CG9-11, CG9-41, CG9-51L, CG9-51LC, CG9-51R, CG9-51RC, CG9-61, CG9-82, CGE9-41, FTG9-11L, FTG9-11L+R, FTG9-11R, FTGC9-11L, FTGC9-11L+R, FTGC9-11R |                 |                     |

accessories

extensions



|                    |  |                 |                     |
|--------------------|--|-----------------|---------------------|
| <b>GEV No.</b>     | 527396   | <b>Ref. No.</b> | 12020466<br>R619913 |
| <b>description</b> | thread bolt for griddle L 50mm thread M10 stainless steel  |                 |                     |
| <b>For models:</b> | CG9-51LC, CG9-51RC, FTE7-05, FTE7-05L, FTE7-05R, FTE7-10, FTE7-10L, FTE7-10L+R, FTE7-10R, FTE9-05L, FTE9-05R, FTE9-10L, FTE9-10L+R, FTE9-10R, FTEC7-05L, FTEC7-10L, FTEC9-05, FTEC9-05L, FTEC9-05R, FTEC9-05USMC, FTEC9-10, FTEC9-10L, FTEC9-10L+R, FTEC9-10R, FTEC9-10USMC, FTG7-05, FTG7-05L, FTG7-05R, FTG7-10, FTG7-10L, FTG7-10L+R, FTG7-10R, FTG9-05L, FTG9-05R, FTG9-05VL, FTG9-05VR, FTG9-10L, FTG9-10L+R, FTG9-10R, FTG9-10VL, FTG9-10VL+R, FTG9-10VR, FTGC7-05L, FTGC7-10L, FTGC9-05, FTGC9-05L, FTGC9-05R, FTGC9-10, FTGC9-10L, FTGC9-10L+R...(Other models you can see in the webshop) |                 |                     |

Зип Общепит

vsezip.ru

+7(812)987-08-81



1

|                    |  |                 |                      |
|--------------------|--|-----------------|----------------------|
| <b>GEV No.</b>     | 696850   | <b>Ref. No.</b> | 12044773<br>12160858 |
| <b>description</b> | door handle for combi-steamer L 200mm W 108mm H 52mm black |                 |                      |



1

|                    |  |                 |          |
|--------------------|--|-----------------|----------|
| <b>GEV No.</b>     | 696853   | <b>Ref. No.</b> | 12044776 |
| <b>description</b> | door handle for combi-steamer L 200mm W 65mm H 50mm black shaft 8x8mm                                  |                 |          |
| <b>For models:</b> | ACE-201, ACE-202, ACG-201, ACG-202, AE-201, AE-202, AG-201, AG-202, APE-201, APE-202, APG-201, APG-202 |                 |          |





1

|                    |  |                 |          |
|--------------------|--|-----------------|----------|
| <b>GEV No.</b>     | 692902   | <b>Ref. No.</b> | 12161224 |
| <b>description</b> | door handle L 180mm W 50mm handle ø 50mm spring length 55mm threaded black mounting distance 30mm mounting thread M3 |                 |          |



1

|   |   |                 |                   |
|---|---|-----------------|-------------------|
| <b>GEV No.</b>  | 694666  | <b>Ref. No.</b> | 12024750          |
| <b>description</b>  | door handle L 180mm W 56mm H 56mm handle ø 32mm spring length 46mm black plastic mounting distance 40mm mounting thread M5                |                 |                   |
| <b>For models:</b>  | COE-061, COE-101, COE-102, COG-061, COG-101, COG-102, VE-061, VE-101, VE-102, VG-101, VG-102, VPE-061, VPE-101, VPE-102, VPG-101, VPG-102 |                 |                   |
| <b>spare parts for</b>  | 694666  |                 |                   |
|  | <b>GEV No.</b>  | 514390          | <b>Ref. No.</b> — |
|   | spring for door handle ø 6mm L 54mm W 27.5mm  |                 |                   |



1

|   |  |                 |  |
|---|--|-----------------|--|
| <b>GEV No.</b>  | 693575   | <b>Ref. No.</b> | 12031594<br>RT2400152                              |
| <b>description</b>  | door handle L 200mm W 50mm H 66mm blue plastic |                 |  |
| <b>accessories for</b>  | 693575   |                 |  |
|  | <b>GEV No.</b>                                 | 693576          | <b>Ref. No.</b> 12029692<br>RT2400176<br>RT2402762 |
|   | catch L 83mm ø 41mm clamp length 43mm BL 45mm  |                 |  |



1

|                    |  |                 |                      |
|--------------------|--|-----------------|----------------------|
| <b>GEV No.</b>     | 692752   | <b>Ref. No.</b> | 12044774<br>12047580 |
| <b>description</b> | door handle L 200mm W 50mm handle ø 50mm spring length 55mm threaded black mounting distance 30mm mounting thread M3   |                 |                      |
| <b>For models:</b> | ACE-061, ACE-101, ACE-102, ACG-061, ACG-101, ACG-102, AE-061, AE-061W, AE-101, AE-101W, AE-102, AE-102W, AG-061, AG-061W, AG-101, AG-101W, AG-102, AG-102W, APE-061, APE-061W, APE-101, APE-101W, APE-102, APE-102W, APG-061, APG-061W, APG-101, APG-101W, APG-102, APG-102W |                 |                      |

edgmount latches

handle latches

CAFF/FERMOD

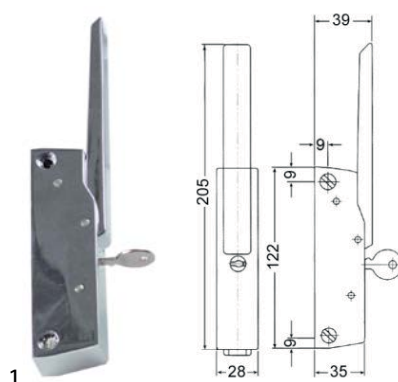

|                        |  |                 |                        |
|------------------------|--|-----------------|------------------------|
| <b>GEV No.</b>         | 700556   | <b>Ref. No.</b> | 12032862<br>6033010007 |
| <b>description</b>     | catch L 122mm mounting distance 104mm lockable refrigeration units G 885 W 28mm handle length 135mm overall height 205mm |                 |                        |
| <b>For models:</b>     | CCF-10, CCF-10CI, CCF-20, CCF-20CI, CCF-40, CCF-40CI   |                 |                        |
| <b>accessories for</b> | 700556   |                 |                        |
|                        | <b>GEV No.</b>   | 690418          | <b>Ref. No.</b> —      |
|                        | door catch L 36mm W 19mm H 29mm mounting distance 12mm zinc-coated steel for refrigeration units                         |                 |                        |
|                        | <b>GEV No.</b>   | 690419          | <b>Ref. No.</b> —      |
|                        | door catch L 52mm W 20mm H 30mm mounting distance 26-37mm zamak for refrigeration units                                  |                 |                        |
|                        | <b>GEV No.</b>   | 700061          | <b>Ref. No.</b> —      |
|                        | door catch L 58mm W 20mm H 35mm mounting distance 42mm chrome-plated brass for headed units                              |                 |                        |
|                        | <b>GEV No.</b>   | 700435          | <b>Ref. No.</b> —      |
|                        | door catch L 58mm W 20mm H 35mm mounting distance 42mm zamak for refrigeration units                                     |                 |                        |

espagnolette locks

universal



|                    |   |                 |                     |
|--------------------|---|-----------------|---------------------|
| <b>GEV No.</b>     | 690041  | <b>Ref. No.</b> | 12018701<br>R260544 |
| <b>description</b> | cam L 148mm mounting distance 32mm  |                 |                     |
| <b>For models:</b> | HCG-10-11, HCG-10-21, HCG-20-11, HCG-20-21, HCG-2-10-11, HCG-6-11, HCV-10-11, HCV-10-21, HCV-2-10-21, HCV-6-11, HE-10-11, HE-10-21, HE-2-10-11, HE-6-11, HG-10-11, HG-10-21, HG-2-10-11, HME-10-11, HME-10-21, HME-20-11, HME-20-21, HME-2-10-11, HME-6-11, HMG-10-11, HMG-10-11UL, HMG-10-21, HMG-10-21UL, HMG-20-11, HMG-2-10-11, HMG-6-11, HMI-10-11, HMI-10-11UL, HMI-10-21, HMI-10-21UL, HMI-2-10-11, HMI-6-11, HMI-6-11UL, HMM-10-11, HMM-10-11UL, HMM-10-21, HMM-10-21UL, HMM-20-11, HMM-20-11UL, HMM-20-21, HMM-2-10-11, HMM-40-11-USMC, HMM-6-11, HMM-6-11UL, HMP-10-11, HMP-10-21...(Other models you can see in the webshop) |                 |                     |

Зип Общепит

vsezip.ru

+7(812)987-08-81



|                    |   |                 |                     |
|--------------------|---|-----------------|---------------------|
| <b>GEV No.</b>     | 700771  | <b>Ref. No.</b> | 12024673<br>T130509 |
| <b>description</b> | latch gear opening to the left shaft intake ø 8x8mm L 170mm W 40mm H 40mm   |                 |                     |
| <b>For models:</b> | ACE-201, ACE-202, ACG-201, ACG-202, AE-201, AE-202, AG-201, AG-202, APE-201, APE-202, APG-201, APG-202, COE-201, COE-202, COG-201, COG-202, HCG-10-11, HCG-10-21, HCG-20-11, HCG-20-21, HCG-2-10-11, HCG-2-20-11, HCG-6-11, HEI-10-11, HEI-10-21, HEI-20-11, HEI-20-21, HEI-6-11, HEM-10-11, HEM-10-21, HEM-20-11, HEM-20-21, HEM-6-11, HEP-10-11, HEP-10-21, HEP-20-11, HEP-20-21, HEP-6-11, HGC-10-11, HGC-10-21, HGC-20-11, HGC-20-21, HGC-6-11, HGP-10-21, HGP-20-21, HGV-10-11, HGV-10-21, HGV-20-11, HGV-20-21, HME-10-11...(Other models you can see in the webshop) |                 |                     |

producer-specific

FAGOR

group 1



|                    |  |                 |                     |
|--------------------|--|-----------------|---------------------|
| <b>GEV No.</b>     | 694266   | <b>Ref. No.</b> | 12001539<br>R090514 |
| <b>description</b> | bar door catch ø 10mm L 415mm  |                 |                     |
| <b>For models:</b> | COE-201, COG-201, HCG-20-11, HCG-20-21, HCG-2-20-11, HEI-20-11, HEM-20-11, HEP-20-11, HGC-20-11, HGV-20-11, HME-20-11, HME-20-21, HME-2-20-11, HMG-20-11, HMM-20-11, HMM-20-11UL, HMM-20-21, HMM-20-21UL, HMM-2-20-11, HMM-40-11-USMC, HMP-20-11, HMP-20-21, HMP-2-20-11, HVG-20-11, HVG-20-21, HVG-2-20-21, MFHMM-20-11, VE-201, VG-201, VPE-201, VPG-201 |                 |                     |



|                    |  |                 |                     |
|--------------------|--|-----------------|---------------------|
| <b>GEV No.</b>     | 694258   | <b>Ref. No.</b> | 12014385<br>T300507 |
| <b>description</b> | bar for door latch ø 10mm L 235mm                                |                 |                     |
| <b>For models:</b> | HEI-10-21, HEM-10-21, HEP-10-21, HGC-10-21, HGP-10-21, HGV-10-21 |                 |                     |





|                    |  |                 |                     |
|--------------------|--|-----------------|---------------------|
| <b>GEV No.</b>     | 691050   | <b>Ref. No.</b> | 12014653<br>R020502 |
| <b>description</b> | bar ø 10mm for door latch L 113.5mm  |                 |                     |
| <b>For models:</b> | HCG-10-11, HCG-10-21, HCG-2-10-11, HCG-6-11, HCV-10-11, HCV-10-21, HCV-2-10-21, HCV-6-11, HE-10-11, HE-10-21, HE-2-10-11, HEI-10-11, HEM-10-11, HEP-10-11, HG-10-11, HG-10-21, HG-2-10-11, HGC-10-11, HGV-10-11, HME-10-11, HME-10-21, HME-2-10-11, HME-6-11, HMG-10-11, HMG-10-11UL, HMG-10-21, HMG-10-21UL, HMG-2-10-11, HMI-10-11, HMI-10-11UL, HMI-10-21, HMI-10-21UL, HMI-2-10-11, HMM-10-11, HMM-10-11UL, HMM-10-21, HMM-10-21UL, HMM-20-11, HMM-2-10-11, HMM-6-11, HMP-10-11, HMP-10-21, HMP-2-10-11, HMP-6-11, HVG-10-11, HVG-10-11UL, HVG-10-21, HVG-10-21UL, HVG-2-10-11, MFHVG-10-11, MFHVG-10-21 |                 |                     |





Зип Общепит  
vsezip.ru  
+7(812)987-08-81

|   |   |                 |                     |
|---|---|-----------------|---------------------|
|  |   |                 |                     |
| 1   |   |                 |                     |
| <b>GEV No.</b>  | 690041  | <b>Ref. No.</b> | 12018701<br>R260544 |
| <b>description</b>  | cam L 148mm mounting distance 32mm  |                 |                     |
| <b>For models:</b>  | HCG-10-11, HCG-10-21, HCG-20-11, HCG-20-21, HCG-2-10-11, HCG-6-11, HCV-10-11, HCV-10-21, HCV-2-10-21, HCV-6-11, HE-10-11, HE-10-21, HE-2-10-11, HE-6-11, HG-10-11, HG-10-21, HG-2-10-11, HME-10-11, HME-10-21, HME-20-11, HME-20-21, HME-2-10-11, HME-6-11, HMG-10-11, HMG-10-11UL, HMG-10-21, HMG-10-21UL, HMG-20-11, HMG-2-10-11, HMG-6-11, HMI-10-11, HMI-10-11UL, HMI-10-21, HMI-10-21UL, HMI-2-10-11, HMI-6-11, HMI-6-11UL, HMM-10-11, HMM-10-11UL, HMM-10-21, HMM-10-21UL, HMM-20-11, HMM-20-11UL, HMM-20-21, HMM-2-10-11, HMM-40-11-USMC, HMM-6-11, HMM-6-11UL, HMP-10-11, HMP-10-21...(Other models you can see in the webshop) |                 |                     |

|  |   |                 |                     |
|--|---|-----------------|---------------------|
|  |   |                 |                     |
| 1  |   |                 |                     |
| <b>GEV No.</b>   | 700771  | <b>Ref. No.</b> | 12024673<br>T130509 |
| <b>description</b>   | latch gear opening to the left shaft intake $\varnothing$ 8x8mm L 170mm W 40mm H 40mm   |                 |                     |
| <b>For models:</b>   | ACE-201, ACE-202, ACG-201, ACG-202, AE-201, AE-202, AG-201, AG-202, APE-201, APE-202, APG-201, APG-202, COE-201, COE-202, COG-201, COG-202, HCG-10-11, HCG-10-21, HCG-20-11, HCG-20-21, HCG-2-10-11, HCG-2-20-11, HCG-6-11, HEI-10-11, HEI-10-21, HEI-20-11, HEI-20-21, HEI-6-11, HEM-10-11, HEM-10-21, HEM-20-11, HEM-20-21, HEM-6-11, HEP-10-11, HEP-10-21, HEP-20-11, HEP-20-21, HEP-6-11, HGC-10-11, HGC-10-21, HGC-20-11, HGC-20-21, HGC-6-11, HGP-10-21, HGP-20-21, HGV-10-11, HGV-10-21, HGV-20-11, HGV-20-21, HME-10-11...(Other models you can see in the webshop) |                 |                     |

|   |   |                 |  |
|---|---|-----------------|--|
|  |   |                 |  |
| 1   |   |                 |  |
| <b>GEV No.</b>  | 700766  | <b>Ref. No.</b> | 12018956<br>12024495<br>R260545<br>T110506 |
| <b>description</b>  | door catch heated units L 44mm W 40mm H 42mm SS mounting distance 26mm  |                 |  |
| <b>For models:</b>  | ACE-201, ACE-202, ACG-201, ACG-202, AE-201, AE-202, AG-201, AG-202, APE-201, APE-202, APG-201, APG-202, COE-201, COE-202, COG-201, COG-202, HCG-10-11, HCG-10-21, HCG-20-11, HCG-20-21, HCG-2-10-11, HCG-2-20-11, HCG-6-11, HCV-10-11, HCV-10-21, HCV-2-10-21, HCV-6-11, HE-10-11, HE-10-21, HE-2-10-11, HE-6-11, HEI-10-11, HEI-10-21, HEI-20-11, HEI-20-21, HEI-6-11, HEM-10-11, HEM-10-21, HEM-20-11, HEM-20-21, HEM-6-11, HEP-10-11, HEP-10-21, HEP-20-11, HEP-20-21, HEP-6-11, HG-10-11, HG-10-21, HG-2-10-11, HGC-10-11...(Other models you can see in the webshop) |                 |  |

|   |  |                 |                                     |
|---|--|-----------------|-------------------------------------|
|   |  |                 |                                     |
| 1   |  |                 |                                     |
| <b>GEV No.</b>  | 690042   | <b>Ref. No.</b> | 12018273<br>R260543                 |
| <b>description</b>  | latch gear opening to the right shaft intake $\varnothing$ 8x8mm L 170mm W 40mm H 40mm   |                 |                                     |
| <b>For models:</b>  | HCG-10-11, HCG-10-21, HCG-20-11, HCG-2-10-11, HCG-6-11, HCV-10-11, HCV-10-21, HCV-2-10-21, HCV-6-11, HE-10-11, HE-10-21, HE-2-10-11, HE-6-11, HG-10-11, HG-10-21, HG-2-10-11, HME-10-11, HME-10-21, HME-20-11, HME-20-21, HME-2-10-11, HME-6-11, HMG-10-11, HMG-10-11UL, HMG-10-21, HMG-10-21UL, HMG-20-11, HMG-2-10-11, HMG-6-11, HMI-10-11, HMI-10-11UL, HMI-10-21, HMI-10-21UL, HMI-2-10-11, HMI-6-11, HMI-6-11UL, HMM-10-11, HMM-10-11UL, HMM-10-21, HMM-10-21UL, HMM-20-11, HMM-20-11UL, HMM-20-21, HMM-2-10-11, HMM-6-11, HMM-6-11UL, HMP-10-11, HMP-10-21, HMP-20-11, HMP-20-21...(Other models you can see in the webshop) |                 |                                     |
| <b>accessories for</b>  | 690042   |                 |                                     |
|  | <b>GEV No.</b>   | 690040          | <b>Ref. No.</b> —                   |
|   | door catch with roller H 42mm L 40mm W 40mm zinc die cast mounting distance 26mm type 0751 series  |                 |                                     |
|  | <b>GEV No.</b>   | 690041          | <b>Ref. No.</b> 12018701<br>R260544 |
|   | cam L 148mm mounting distance 32mm   |                 |                                     |
|  | <b>GEV No.</b>   | 691050          | <b>Ref. No.</b> 12014653<br>R020502 |
|   | bar $\varnothing$ 10mm for door latch L 113.5mm  |                 |                                     |

|   |   |                 |                                     |
|---|---|-----------------|-------------------------------------|
|  |   |                 |                                     |
| 1   |   |                 |                                     |
| <b>GEV No.</b>  | 691044  | <b>Ref. No.</b> | 12017896<br>R660532                 |
| <b>description</b>  | door handle handle $\varnothing$ 23mm metal mounting distance 43mm flange 28x68mm shaft 7x7mm   |                 |                                     |
| <b>For models:</b>  | HCG-10-11, HCG-10-21, HCG-20-11, HCG-2-10-11, HCG-6-11, HME-10-11, HME-10-21, HME-20-11, HME-20-21, HME-2-10-11, HME-6-11, HMG-10-11, HMG-10-11UL, HMG-10-21, HMG-10-21UL, HMG-20-11, HMG-2-10-11, HMG-6-11, HMI-10-11, HMI-10-11UL, HMI-10-21, HMI-10-21UL, HMI-2-10-11, HMI-6-11, HMI-6-11UL, HMM-10-11, HMM-10-11UL, HMM-10-21, HMM-10-21UL, HMM-20-11, HMM-20-11UL, HMM-20-21, HMM-2-10-11, HMM-6-11, HMM-6-11UL, HMP-10-11, HMP-10-21, HMP-20-11, HMP-20-21, HMP-2-10-11, HMP-6-11 |                 |                                     |
| <b>accessories for</b>  | 691044  |                 |                                     |
|  | <b>GEV No.</b>  | 690042          | <b>Ref. No.</b> 12018273<br>R260543 |
|   | latch gear opening to the right shaft intake $\varnothing$ 8x8mm L 170mm W 40mm H 40mm  |                 |                                     |

|   |  |                 |                     |
|---|--|-----------------|---------------------|
| group 2   |  |                 |                     |
|  |  |                 |                     |
| 1   |  |                 |                     |
| <b>GEV No.</b>  | 700836   | <b>Ref. No.</b> | 12017388<br>T130504 |
| <b>description</b>  | bearing $\varnothing$ 42.6mm H 12.5mm ID $\varnothing$ 21mm brass  |                 |                     |
| <b>For models:</b>  | HCG-10-11, HCG-10-21, HCG-20-11, HCG-20-21, HCG-2-10-11, HCG-6-11, HMM-40-11-USMC, HVG-10-11, HVG-10-21, HVG-20-11, HVG-20-21, HVG-2-10-11 |                 |                     |

Зип Общепит

vsezip.ru

+7(812)9812981

|   |   |                 |                     |
|---|---|-----------------|---------------------|
|  |   |                 |                     |
| 1   |   |                 |                     |
| <b>GEV No.</b>  | 700762  | <b>Ref. No.</b> | 12024389<br>T130515 |
| <b>description</b>  | bearing $\phi$ 44mm for door latch H 23mm ID $\phi$ 11mm thread M5 brass  |                 |                     |
| <b>For models:</b>  | ACE-201, ACE-202, ACG-201, ACG-202, AE-201, AE-202, AG-201, AG-202, APE-201, APE-202, APG-201, APG-202, COE-201, COE-202, COG-201, COG-202, HCG-10-11, HCG-10-21, HCG-20-11, HCG-20-21, HCG-2-10-11, HCG-2-20-11, HCG-6-11, HEI-10-11, HEI-10-21, HEI-20-11, HEI-20-21, HEI-6-11, HEM-10-11, HEM-10-21, HEM-20-11, HEM-20-21, HEM-6-11, HEP-10-11, HEP-10-21, HEP-20-11, HEP-20-21, HEP-6-11, HGC-10-11, HGC-10-21, HGC-20-11, HGC-20-21, HGC-6-11, HGP-10-21, HGP-20-21, HGV-10-11, HGV-10-21, HGV-20-11, HGV-20-21, HME-10-11...(Other models you can see in the webshop) |                 |                     |

|   |   |                 |                     |
|---|---|-----------------|---------------------|
|  |   |                 |                     |
| 1   |   |                 |                     |
| <b>GEV No.</b>  | 700767  | <b>Ref. No.</b> | 12018457<br>T130507 |
| <b>description</b>  | bolt $\phi$ 5.4/8mm for door latch L 22mm   |                 |                     |
| <b>For models:</b>  | HCG-10-11, HCG-10-21, HCG-20-11, HCG-20-21, HCG-2-10-11, HCG-2-20-11, HCG-6-11, HEI-10-11, HEI-10-21, HEI-6-11, HEM-10-11, HEM-10-21, HEM-6-11, HEP-10-11, HEP-10-21, HEP-6-11, HGC-10-11, HGC-10-21, HGC-6-11, HGP-10-21, HGV-10-11, HGV-10-21, HME-10-11, HME-10-21, HME-20-11, HME-20-21, HME-2-10-11, HME-2-20-11, HME-6-11, HMI-10-11, HMI-10-11UL, HMI-10-21, HMI-10-21UL, HMI-2-10-11, HMI-6-11, HMI-6-11UL, HMM-10-11, HMM-10-11UL, HMM-10-21, HMM-10-21UL, HMM-20-11, HMM-20-11UL, HMM-20-21, HMM-20-21UL, HMM-2-10-11, HMM-2-20-11, HMM-40-11-USMC, HMM-6-11, HMM-6-11UL, HMP-10-11...(Other models you can see in the webshop) |                 |                     |



|   |   |                 |                     |
|---|---|-----------------|---------------------|
|  |   |                 |                     |
| 1   |   |                 |                     |
| <b>GEV No.</b>  | 691646  | <b>Ref. No.</b> | 12022265<br>T130511 |
| <b>description</b>  | bracket L 133mm W 45mm thread M6 SS   |                 |                     |
| <b>For models:</b>  | COE-201, COE-202, COG-201, COG-202, HCG-10-11, HCG-10-21, HCG-20-11, HCG-20-21, HCG-2-10-11, HCG-2-20-11, HCG-6-11, HEI-10-11, HEI-10-21, HEI-20-11, HEI-20-21, HEI-6-11, HEM-10-11, HEM-10-21, HEM-20-11, HEM-20-21, HEM-6-11, HEP-10-11, HEP-10-21, HEP-20-11, HEP-20-21, HEP-6-11, HGC-10-11, HGC-10-21, HGC-20-11, HGC-20-21, HGC-6-11, HGP-10-21, HGP-20-21, HGV-10-11, HGV-10-21, HGV-20-11, HGV-20-21, HME-10-11, HME-10-21, HME-20-11, HME-20-21, HME-2-10-11, HME-2-20-11, HME-6-11, HMI-10-11, HMI-10-11UL, HMI-10-21, HMI-10-21UL, HMI-2-10-11, HMI-6-11...(Other models you can see in the webshop) |                 |                     |

|   |   |                 |                     |
|---|---|-----------------|---------------------|
|  |   |                 |                     |
| 1   |   |                 |                     |
| <b>GEV No.</b>  | 505273  | <b>Ref. No.</b> | 12024245<br>T130505 |
| <b>description</b>  | bush for door mechanism   |                 |                     |
| <b>For models:</b>  | ACE-201, ACE-202, ACG-201, ACG-202, AE-201, AE-202, AG-201, AG-202, APE-201, APE-202, APG-201, APG-202, COE-201, COG-201, HCG-10-11, HCG-10-21, HCG-20-11, HCG-20-21, HCG-2-10-11, HCG-2-20-11, HCG-6-11, HEI-10-11, HEI-10-21, HEI-20-11, HEI-20-21, HEI-6-11, HEM-10-11, HEM-10-21, HEM-20-11, HEM-20-21, HEM-6-11, HEP-10-11, HEP-10-21, HEP-20-11, HEP-20-21, HEP-6-11, HGC-10-11, HGC-10-21, HGC-20-11, HGC-20-21, HGC-6-11, HGP-10-21, HGP-20-21, HGV-10-11, HGV-10-21, HGV-20-11, HGV-20-21, HME-10-11, HME-10-21, HME-20-11, HME-20-21, HME-2-10-11, HME-2-20-11, HME-6-11, HMI-10-11, HMI-10-11UL, HMI-10-21, HMI-10-21UL, HMI-2-10-11, HMI-6-11...(Other models you can see in the webshop) |                 |                     |

|   |   |                 |                     |
|---|---|-----------------|---------------------|
|  |   |                 |                     |
| 1   |   |                 |                     |
| <b>GEV No.</b>  | 700765  | <b>Ref. No.</b> | 12024164<br>T130506 |
| <b>description</b>  | compression spring $\phi$ 8.1mm L 20.4mm wire gauge $\phi$ 1.2mm  |                 |                     |
| <b>For models:</b>  | ACE-201, ACE-202, ACG-201, ACG-202, AE-201, AE-202, AG-201, AG-202, APE-201, APE-202, APG-201, APG-202, COE-201, COE-202, COG-201, COG-202, HCG-10-11, HCG-10-21, HCG-20-11, HCG-20-21, HCG-2-10-11, HCG-2-20-11, HCG-6-11, HEI-10-11, HEI-10-21, HEI-20-11, HEI-20-21, HEI-6-11, HEM-10-11, HEM-10-21, HEM-20-11, HEM-20-21, HEM-6-11, HEP-10-11, HEP-10-21, HEP-20-11, HEP-20-21, HEP-6-11, HGC-10-11, HGC-10-21, HGC-20-11, HGC-20-21, HGC-6-11, HGP-10-21, HGP-20-21, HGV-10-11, HGV-10-21, HGV-20-11, HGV-20-21, HME-10-11...(Other models you can see in the webshop) |                 |                     |

|  |   |                 |                     |
|--|---|-----------------|---------------------|
|  |   |                 |                     |
| 1  |   |                 |                     |
| <b>GEV No.</b>   | 700770  | <b>Ref. No.</b> | 12024657<br>T080504 |
| <b>description</b>   | door catch L 149mm W 29mm H 29mm chrome-plated brass  |                 |                     |
| <b>For models:</b>   | ACE-201, ACE-202, ACG-201, ACG-202, AE-201, AE-202, AG-201, AG-202, APE-201, APE-202, APG-201, APG-202, COE-201, COE-202, COG-201, COG-202, HCG-10-11, HCG-10-21, HCG-20-11, HCG-20-21, HCG-2-10-11, HCG-2-20-11, HCG-6-11, HEI-10-11, HEI-10-21, HEI-20-11, HEI-20-21, HEI-6-11, HEM-10-11, HEM-10-21, HEM-20-11, HEM-20-21, HEM-6-11, HEP-10-11, HEP-10-21, HEP-20-11, HEP-20-21, HEP-6-11, HGC-10-11, HGC-10-21, HGC-20-11, HGC-20-21, HGC-6-11, HGP-10-21, HGP-20-21, HGV-10-11, HGV-10-21, HGV-20-11, HGV-20-21, HME-10-11...(Other models you can see in the webshop) |                 |                     |

|  |   |                 |                     |
|--|---|-----------------|---------------------|
|  |   |                 |                     |
| 1  |   |                 |                     |
| <b>GEV No.</b>   | 700768  | <b>Ref. No.</b> | 12024095<br>T130502 |
| <b>description</b>   | door handle $\phi$ 50mm shaft intake $\phi$ 8x8mm L 180mm   |                 |                     |
| <b>For models:</b>   | COE-201, COE-202, COG-201, COG-202, HCG-10-11, HCG-10-21, HCG-20-11, HCG-20-21, HCG-2-10-11, HCG-2-20-11, HCG-6-11, HEI-10-11, HEI-10-21, HEI-20-11, HEI-20-21, HEI-6-11, HEM-10-11, HEM-10-21, HEM-20-11, HEM-20-21, HEM-6-11, HEP-10-11, HEP-10-21, HEP-20-11, HEP-20-21, HEP-6-11, HGC-10-11, HGC-10-21, HGC-20-11, HGC-20-21, HGC-6-11, HGP-10-21, HGP-20-21, HGV-10-11, HGV-10-21, HGV-20-11, HGV-20-21, HME-10-11, HME-10-21, HME-20-11, HME-20-21, HME-2-10-11, HME-2-20-11, HME-6-11, HMI-10-11, HMI-10-11UL, HMI-10-21, HMI-10-21UL, HMI-2-10-11, HMI-6-11...(Other models you can see in the webshop) |                 |                     |

|   |  |        |                 |                     |
|---|--|--------|-----------------|---------------------|
| <b>accessories for</b>  | 700768   |        |                 |                     |
|  | <b>GEV No.</b>   | 700762 | <b>Ref. No.</b> | 12024389<br>T130515 |
|   | bearing $\phi$ 44mm for door latch H 23mm ID $\phi$ 11mm thread M5 brass       |        |                 |                     |
|  | <b>GEV No.</b>   | 700763 | <b>Ref. No.</b> | 12024505<br>T130514 |
|   | spring holder $\phi$ 43mm for door latch H 12.5mm ID $\phi$ 20mm brass         |        |                 |                     |
|  | <b>GEV No.</b>   | 700771 | <b>Ref. No.</b> | 12024673<br>T130509 |
|   | latch gear opening to the left shaft intake $\phi$ 8x8mm L 170mm W 40mm H 40mm |        |                 |                     |





Зип Общепит  
vsezip.ru  
(812) 987-08-81

|   |   |                 |                     |
|---|---|-----------------|---------------------|
|  |   |                 |                     |
| <b>GEV No.</b>  | 560068  | <b>Ref. No.</b> | 12010213<br>Q032032 |
| <b>description</b>  | flat-headed bolt thread M5 thread L 16mm SS DIN 7985/ISO 7045 Qty 20 pcs intake Phillips head ø 10mm head thickness 2mm   |                 |                     |
| <b>For models:</b>  | ACE-201, ACE-202, ACG-201, ACG-202, AD-120B, AD-120BBTDD-UK, AD-120C, AD-120HY, AD-15, AD-15D, AD-20C-UK, AD-21, AD-21B, AD-21BDD, AD-21C, AD-21D, AD-21DD, AD-21W, AD-90BA, AD-90BBT, AD-90BDD, ADE-120B, AE-201, AE-202, AG-201, AG-202, APE-201, APE-202, APG-201, APG-202, COE-201, COE-202, COG-201, COG-202, ECO-120B, FI-100B, FI-100BBT-UK, FI-120B, FI-120C, FI-120HY-CLINIC, FI-80BBT-UK, GA-20, GA-20D, GA-40, GA-40D, HCG-10-11, HCG-10-21, HCG-20-11, HCG-20-21, HCG-2-10-11...(Other models you can see in the webshop) |                 |                     |

|   |  |                 |          |
|---|--|-----------------|----------|
|  |  |                 |          |
| <b>GEV No.</b>  | 560549   | <b>Ref. No.</b> | 12010236 |
| <b>description</b>  | grub screw thread M6 L 15mm SS DIN 916/ISO 4029 intake internal hexagon WS 3 Qty 1 pcs   |                 |          |
| <b>For models:</b>  | ACE-201, ACE-202, ACG-201, ACG-202, AE-201, AE-202, AG-201, AG-202, APE-201, APE-202, APG-201, APG-202, CG9-20, CG9-20AD, CG9-20H, CG9-20PLUS, CG9-40, CG9-40AD, CG9-40H, CG9-40PLUS, CG9-41, CG9-41H, CG9-51L, CG9-51LC, CG9-51R, CG9-51RC, CG9-60, CG9-60AD, CG9-60H, CG9-60PLUS, CG9-61, CG9-61H, CG9-61OP, CG9-82, CGE9-41, CGE9-41AD, CGE9-41PLUS, CGF9-120D, CGF9-120I, CGF9-121D, CGF9-121I, COE-201, COE-202, COG-201, COG-202, HEI-10-11, HEI-20-11, HEI-20-21, HEI-6-11, HEM-10-11...(Other models you can see in the webshop) |                 |          |

|   |   |                 |  |
|---|---|-----------------|--|
|  |   |                 |  |
| <b>GEV No.</b>  | 560132  | <b>Ref. No.</b> | 12010194<br>12010284<br>Q162030<br>Q163030 |
| <b>description</b>  | hexagonal nut thread M5 H 4mm WS 8 SS DIN/ISO DIN 934 / ISO 4032/8673 Qty 20 pcs  |                 |  |
| <b>For models:</b>  | ACE-061, ACE-101, ACE-102, ACE-201, ACE-202, ACG-061, ACG-101, ACG-102, ACG-201, ACG-202, AD-120, AD-120B, AD-120BBTDD-UK, AD-120C, AD-120CW, AD-120HY, AD-15, AD-15D, AD-20C-UK, AD-21, AD-21B, AD-21BDD, AD-21C, AD-21D, AD-21DD, AD-21W, AD-45BBT, AD-48, AD-48B, AD-48BDD, AD-48C, AD-48D, AD-48DD, AD-48HY, AD-48W, AD-64, AD-64B, AD-64BBT, AD-64BDD, AD-64BTDD, AD-64C, AD-64CW, AD-64D, AD-64DD, AD-64HY, AD-72, AD-72W, AD-90, AD-90BA, AD-90BBT...(Other models you can see in the webshop) |                 |  |

|   |   |                 |                                   |
|---|---|-----------------|-----------------------------------|
|  |   |                 |                                   |
| <b>GEV No.</b>  | 511212  | <b>Ref. No.</b> | 12010255<br>Q162040<br>Q163140000 |
| <b>description</b>  | hexagonal nut thread M6 H 5mm WS 10 SS DIN/ISO DIN 934 / ISO 4032/8673 Qty 1 pcs  |                 |                                   |
| <b>For models:</b>  | ACE-061, ACE-101, ACE-102, ACE-201, ACE-202, ACG-061, ACG-101, ACG-102, ACG-201, ACG-202, AD-120, AD-120B, AD-120BBTDD-UK, AD-120C, AD-120CW, AD-120HY, AD-15, AD-15D, AD-20C-UK, AD-21, AD-21B, AD-21BDD, AD-21C, AD-21D, AD-21DD, AD-21W, AD-45BBT, AD-48, AD-48B, AD-48BDD, AD-48C, AD-48D, AD-48DD, AD-48HY, AD-48W, AD-64, AD-64B, AD-64BBT, AD-64BDD, AD-64BTDD, AD-64C, AD-64CW, AD-64D, AD-64DD, AD-64HY, AD-72, AD-72W, AD-90, AD-90BA, AD-90BBT...(Other models you can see in the webshop) |                 |                                   |

|  |   |                 |                     |
|--|---|-----------------|---------------------|
|  |   |                 |                     |
| <b>GEV No.</b>   | 700771  | <b>Ref. No.</b> | 12024673<br>T130509 |
| <b>description</b>   | latch gear opening to the left shaft intake ø 8x8mm L 170mm W 40mm H 40mm   |                 |                     |
| <b>For models:</b>   | ACE-201, ACE-202, ACG-201, ACG-202, AE-201, AE-202, AG-201, AG-202, APE-201, APE-202, APG-201, APG-202, COE-201, COE-202, COG-201, COG-202, HCG-10-11, HCG-10-21, HCG-20-11, HCG-20-21, HCG-2-10-11, HCG-2-20-11, HCG-6-11, HEI-10-11, HEI-10-21, HEI-20-11, HEI-20-21, HEI-6-11, HEM-10-11, HEM-10-21, HEM-20-11, HEM-20-21, HEM-6-11, HEP-10-11, HEP-10-21, HEP-20-11, HEP-20-21, HEP-6-11, HGC-10-11, HGC-10-21, HGC-20-11, HGC-20-21, HGC-6-11, HGP-10-21, HGP-20-21, HGV-10-11, HGV-10-21, HGV-20-11, HGV-20-21, HME-10-11...(Other models you can see in the webshop) |                 |                     |

|   |  |                 |                     |
|---|--|-----------------|---------------------|
|  |  |                 |                     |
| <b>GEV No.</b>  | 560123   | <b>Ref. No.</b> | 12009872<br>Q262040 |
| <b>description</b>  | lock washer ID ø 6.3mm ED ø 11mm SS DIN127 Qty 20 pcs for thread M6  |                 |                     |
| <b>For models:</b>  | ACE-061, ACE-101, ACE-102, ACE-201, ACE-202, AD-120, AD-120B, AD-120BBTDD-UK, AD-120C, AD-120CW, AD-120HY, AD-15, AD-15D, AD-20C-UK, AD-21, AD-21B, AD-21BDD, AD-21C, AD-21D, AD-21DD, AD-21W, AD-45BBT, AD-48, AD-48B, AD-48BDD, AD-48C, AD-48D, AD-48DD, AD-48HY, AD-48W, AD-64, AD-64B, AD-64BBT, AD-64BDD, AD-64BTDD, AD-64C, AD-64CW, AD-64D, AD-64DD, AD-64HY, AD-72, AD-72W, AD-90, AD-90BA, AD-90BBT, AD-90BDD, AD-90DD, ADE-120, ADE-120B, AE-061...(Other models you can see in the webshop) |                 |                     |

|   |  |                 |                                |
|---|--|-----------------|--------------------------------|
|  |  |                 |                                |
| <b>GEV No.</b>  | 516198   | <b>Ref. No.</b> | 12010285<br>Q271033<br>Q301033 |
| <b>description</b>  | retaining ring E D1 ø 6mm D2 ø 12mm SS DIN 6799 thickness 0.7mm for shaft ø 7-9mm  |                 |                                |
| <b>For models:</b>  | COE-201, COE-202, COG-201, COG-202, FE-710, FE-720, FE9-05, FE9-05S, FE9-05USMC, FE9-10, FE-920, HCG-10-11, HCG-10-21, HCG-20-11, HCG-20-21, HCG-2-10-11, HCG-2-20-11, HCG-6-11, HCV-10-11, HCV-10-21, HCV-2-10-21, HCV-6-11, HE-10-11, HE-10-21, HE-2-10-11, HE-6-11, HEI-10-21, HEI-20-21, HEM-10-21, HEM-20-21, HEP-10-21, HEP-20-21, HG-10-21, HG-2-10-11, HGC-10-21, HGC-20-21, HGP-10-21, HGP-20-21, HGV-10-11, HGV-10-21, HGV-20-11, HGV-20-21, HME-10-11, HME-10-21, HME-20-11, HME-20-21, HME-2-10-11, HME-2-20-11, HME-6-11, HMG-10-11...(Other models you can see in the webshop) |                 |                                |

|   |   |                 |                     |
|---|---|-----------------|---------------------|
|  |   |                 |                     |
| <b>GEV No.</b>  | 700769  | <b>Ref. No.</b> | 12021034<br>T130508 |
| <b>description</b>  | shaft ø 8x8mm for door latch L 80mm   |                 |                     |
| <b>For models:</b>  | HCG-10-11, HCG-10-21, HCG-20-11, HCG-20-21, HCG-2-10-11, HCG-2-20-11, HCG-6-11, HEI-10-11, HEI-10-21, HEI-6-11, HEM-10-11, HEM-10-21, HEM-6-11, HEP-10-11, HEP-10-21, HEP-6-11, HGC-10-11, HGC-10-21, HGC-6-11, HGP-10-21, HGV-10-11, HGV-10-21, HME-10-11, HME-10-21, HME-20-11, HME-20-21, HME-2-10-11, HME-2-20-11, HME-6-11, HMI-10-11, HMI-10-11UL, HMI-10-21, HMI-10-21UL, HMI-2-10-11, HMI-6-11, HMI-6-11UL, HMM-10-11, HMM-10-11UL, HMM-10-21, HMM-10-21UL, HMM-20-11, HMM-20-11UL, HMM-20-21, HMM-20-21UL, HMM-2-10-11, HMM-2-20-11, HMM-40-11-USMC, HMM-6-11, HMM-6-11UL, HMP-10-11...(Other models you can see in the webshop) |                 |                     |

Зип-Общепит hinges



spring assisted hinges producer specific

CORECO

+7(812)987-08-81



1

|   |  |                 |   |
|---|--|-----------------|---|
| <b>GEV No.</b>  | 690763   | <b>Ref. No.</b> | 12038130<br>6033010100                    |
| <b>description</b>  | spring assisted hinge right/left L 111mm W 75mm refrigerator mounting distance 25mm  |                 |   |
| <b>For models:</b>  | ADAEP-1602, ADAEP-801, ADAFN-1602, ADAFN-801, ADAFP-1602, ADAFP-801, ADMCN-135, ADMCN-180, ADMCN-225, ADMCP-135, ADMCP-180, ADMCP-225, ADMFN-135, ADMFN-180, ADMFN-225, ADMFP-135, ADMFP-135-GR, ADMFP-135HD, ADMFP-135PC, ADMFP-180, ADMFP-180-GR, ADMFP-180HDD, ADMFP-180HDD, ADMFP-180PC, ADMFP-225, ADMFP-225-GR, ADMFP-225HDD, ADMFP-225HDD, ADMFP-225HHDD, ADMFP-225PC, AEF-801AD, AEF-802AD, AEP-1402, AEP-1602, AEP-1602AD, AEP-1603AD, AEP-1604AD, AEP-2103, AEP-701, AEP-801, AEP-802, AF-1402-MIX, AF-1403-C, AF-1403-P, AF-1404-C, AF-1404-P, AF-1602-MIX, AF-1603-C, AF-1603-P, AF-1604-C...(Other models you can see in the webshop) |                 |   |
| <b>accessories for</b>  | 690763   |                 |   |
|   | <b>GEV No.</b>   | 691738          | <b>Ref. No.</b><br>12038085<br>6033010098 |
|   | hinge L 100mm W 48mm mounting pos. left thickness 5mm for door for refrigerated counters   |                 |   |
|  | <b>GEV No.</b>   | 701161          | <b>Ref. No.</b><br>12037017<br>6033010130 |
|   | hinge camp mounting pos. bottom right L 100mm W 48mm H 17mm shaft diameter 8x8mm   |                 |   |

|   |   |        |                 |                     |
|---|---|--------|-----------------|---------------------|
|  | <b>GEV No.</b>  | 700763 | <b>Ref. No.</b> | 12024505<br>T130514 |
| <b>description</b>  | spring holder ø 43mm for door latch H 12.5mm ID ø 20mm brass  |        |                 |                     |
| <b>For models:</b>  | ACE-201, ACE-202, ACG-201, ACG-202, AE-201, AE-202, AG-201, AG-202, APE-201, APE-202, APG-201, APG-202, COE-201, COE-202, COG-201, COG-202, HCG-10-11, HCG-10-21, HCG-20-11, HCG-20-21, HCG-2-10-11, HCG-2-20-11, HCG-6-11, HEI-10-11, HEI-10-21, HEI-20-11, HEI-20-21, HEI-6-11, HEM-10-11, HEM-10-21, HEM-20-11, HEM-20-21, HEM-6-11, HEP-10-11, HEP-10-21, HEP-20-11, HEP-20-21, HEP-6-11, HGC-10-11, HGC-10-21, HGC-20-11, HGC-20-21, HGC-6-11, HGP-10-21, HGP-20-21, HGV-10-11, HGV-10-21, HGV-20-11, HGV-20-21, HME-10-11...(Other models you can see in the webshop) |        |                 |                     |

|   |  |        |                 |                     |
|---|--|--------|-----------------|---------------------|
|  | <b>GEV No.</b>   | 560126 | <b>Ref. No.</b> | 12009890<br>Q242030 |
| <b>description</b>  | tooth lock washer ID ø 5.2mm ED ø 10mm SS DIN/ISO DIN 6798A Qty 20 pcs for thread M5   |        |                 |                     |
| <b>For models:</b>  | ACE-061, ACE-101, ACE-102, ACE-201, ACE-202, ACG-061, ACG-101, ACG-102, ACG-201, ACG-202, AD-120, AD-120B, AD-120BTTDD-UK, AD-120C, AD-120CW, AD-120HY, AD-15, AD-15D, AD-20C-UK, AD-21, AD-21B, AD-21BDD, AD-21C, AD-21D, AD-21DD, AD-21W, AD-45BBT, AD-48, AD-48B, AD-48BDD, AD-48C, AD-48D, AD-48DD, AD-48HY, AD-48W, AD-64, AD-64B, AD-64BBT, AD-64BDD, AD-64C, AD-64CW, AD-64D, AD-64DD, AD-64HY, AD-72, AD-72W, AD-90, AD-90BA, AD-90BBT, AD-90BDD...(Other models you can see in the webshop) |        |                 |                     |

miscellaneous

|   |                |        |                 |                     |
|---|----------------|--------|-----------------|---------------------|
|  | <b>GEV No.</b> | 691873 | <b>Ref. No.</b> | 12019998<br>U060526 |
| <b>description</b>  | bolt           |        |                 |                     |

|   |                |        |                 |         |
|---|----------------|--------|-----------------|---------|
|  | <b>GEV No.</b> | 691064 | <b>Ref. No.</b> | R260546 |
| <b>description</b>  | catch hook     |        |                 |         |



|   |                |        |                 |                     |
|---|----------------|--------|-----------------|---------------------|
|  | <b>GEV No.</b> | 691872 | <b>Ref. No.</b> | 12020157<br>U060518 |
| <b>description</b>  | sleeve         |        |                 |                     |







Зип Общепит

vsezip.ru

+7(812)987-08-81

|   |  |  |  |        |                 |                        |   |
|---|--|--|--|--------|-----------------|------------------------|---|
|  |  |  |  |        |                 |                        |   |
| 1   |  |  |  |        |                 |                        |   |
| <b>GEV No.</b>  | 700830   | <b>Ref. No.</b>  | 12031972<br>12034927<br>12058528<br>6000300007<br>6009991521<br>6033010003<br>6033010030 |        |                 |                        |   |
| <b>description</b>  | spring assisted hinge right/left L 75mm W 26mm H 102mm refrigeration units mounting distance 25mm  |  |  |        |                 |                        |   |
| <b>For models:</b>  | AEP-1402, AEP-1403, AEP-1404, AEP-1602, AEP-1603, AEP-1604, AEP-2103, AEP-701, AEP-702, AEP-801, AEP-802, AF-1402-MIX, AF-1403-C, AF-1403-P, AF-1404-C, AF-1404-P, AF-1602-MIX, AF-1603-C, AF-1603-P, AF-1604-C, AF-1604-P, AF-2104-C, AF-2104-P, AF-2105-C, AF-2105-P, AF-2106-C, AF-2106-P, AF-702-C, AF-702-P, AF-802-C, AF-802-P, AFN-1402, AFN-1403, AFN-1404, AFN-1602, AFN-1603, AFN-1604, AFN-701, AFN-702, AFN-801, AFN-802, AFP-1402, AFP-1402-FORZ, AFP-1402-MIX, AFP-1403, AFP-1403-C, AFP-1403-FORZ, AFP-1403-P, AFP-1404, AFP-1404-C...(Other models you can see in the webshop) |  |  |        |                 |                        |   |
| <b>accessories for</b>  | 700830   |  |  |        |                 |                        |   |
|   |   | <table border="1"> <tr> <td><b>GEV No.</b></td> <td>700854</td> <td><b>Ref. No.</b></td> <td>12036924<br/>6033010084</td> </tr> </table> | <b>GEV No.</b>   | 700854 | <b>Ref. No.</b> | 12036924<br>6033010084 | hinge camp type TRB/L1 36mm mounting pos. bottom right L 100mm W 48mm H 17mm zinc die cast, chrome-plated hole distance 6.5x51x28mm shaft diameter torx 12x12mmmm |
| <b>GEV No.</b>  | 700854   | <b>Ref. No.</b>  | 12036924<br>6033010084   |        |                 |                        |   |

|  |  |                 |                        |
|--|--|-----------------|------------------------|
|  |  |                 |                        |
| 1  |  |                 |                        |
| <b>GEV No.</b>   | 701569   | <b>Ref. No.</b> | 12058502<br>2030800022 |
| <b>description</b>   | spring assisted hinge left/right L 102mm W 75mm mounting distance 25mm |                 |                        |

|  |   |  |                        |        |                 |                        |  |
|--|---|--|------------------------|--------|-----------------|------------------------|--|
|  |   |  |                        |        |                 |                        |  |
| 1  |   |  |                        |        |                 |                        |  |
| <b>GEV No.</b>   | 690763  | <b>Ref. No.</b>  | 12038130<br>6033010100 |        |                 |                        |  |
| <b>description</b>   | spring assisted hinge right/left L 111mm W 75mm refrigerator mounting distance 25mm   |  |                        |        |                 |                        |  |
| <b>For models:</b>   | ADAEP-1602, ADAEP-801, ADAFN-1602, ADAFN-801, ADAFP-1602, ADAFP-801, ADMCN-135, ADMCN-180, ADMCN-225, ADMCP-135, ADMCP-180, ADMCP-225, ADMFN-135, ADMFN-180, ADMFN-225, ADMFP-135, ADMFP-135-GR, ADMFP-135HD, ADMFP-135PC, ADMFP-180, ADMFP-180-GR, ADMFP-180HDD, ADMFP-180HHD, ADMFP-180PC, ADMFP-225, ADMFP-225-GR, ADMFP-225HDD, ADMFP-225HHDD, ADMFP-225HHHD, ADMFP-225PC, AEF-801AD, AEF-802AD, AEP-1402, AEP-1602, AEP-1602AD, AEP-1603AD, AEP-1604AD, AEP-2103, AEP-701, AEP-801, AEP-802, AF-1402-MIX, AF-1403-C, AF-1403-P, AF-1404-C, AF-1404-P, AF-1602-MIX, AF-1603-C, AF-1603-P, AF-1604-C...(Other models you can see in the webshop) |  |                        |        |                 |                        |  |
| <b>accessories for</b>   | 690763  |  |                        |        |                 |                        |  |
|  |    | <table border="1"> <tr> <td><b>GEV No.</b></td> <td>691738</td> <td><b>Ref. No.</b></td> <td>12038085<br/>6033010098</td> </tr> </table> | <b>GEV No.</b>         | 691738 | <b>Ref. No.</b> | 12038085<br>6033010098 | hinge L 100mm W 48mm mounting pos. left thickness 5mm for door for refrigerated counters |
| <b>GEV No.</b>   | 691738  | <b>Ref. No.</b>  | 12038085<br>6033010098 |        |                 |                        |  |
|  |    | <table border="1"> <tr> <td><b>GEV No.</b></td> <td>701161</td> <td><b>Ref. No.</b></td> <td>12037017<br/>6033010130</td> </tr> </table> | <b>GEV No.</b>         | 701161 | <b>Ref. No.</b> | 12037017<br>6033010130 | hinge camp mounting pos. bottom right L 100mm W 48mm H 17mm shaft diameter 8x8mm         |
| <b>GEV No.</b>   | 701161  | <b>Ref. No.</b>  | 12037017<br>6033010130 |        |                 |                        |  |

|  |   |                 |                        |
|--|---|-----------------|------------------------|
| <p>FAGOR</p>  |   |                 |                        |
| 1  |   |                 |                        |
| <b>GEV No.</b>   | 701570  | <b>Ref. No.</b> | 12036986<br>6033010129 |
| <b>description</b>   | hinge camp L 98mm W 46mm mounting distance 80mm mounting pos. bottom left   |                 |                        |
| <b>For models:</b>   | ADAEP-1602, ADAEP-801, ADAFN-1602, ADAFN-801, ADAFP-1602, ADAFP-801, ADMCN-135, ADMCN-180, ADMCN-225, ADMCP-135, ADMCP-180, ADMCP-225, ADMFN-135, ADMFN-180, ADMFN-225, ADMFP-135, ADMFP-135-GR, ADMFP-135HD, ADMFP-135PC, ADMFP-180, ADMFP-180-GR, ADMFP-180HDD, ADMFP-180HHD, ADMFP-180PC, ADMFP-225, ADMFP-225-GR, ADMFP-225HDD, ADMFP-225HHDD, ADMFP-225HHHD, ADMFP-225PC, AEF-801AD, AEF-802AD, AEP-1402, AEP-1602, AEP-1602AD, AEP-1603AD, AEP-1604AD, AEP-2103, AEP-701, AEP-801, AEP-802, AF-1402-MIX, AF-1403-C, AF-1403-P, AF-1404-C, AF-1404-P, AF-1602-MIX, AF-1603-C, AF-1603-P, AF-1604-C...(Other models you can see in the webshop) |                 |                        |

|   |   |                 |                        |
|---|---|-----------------|------------------------|
|  |   |                 |                        |
| 1   |   |                 |                        |
| <b>GEV No.</b>  | 701158  | <b>Ref. No.</b> | 12035423<br>M169090003 |
| <b>description</b>  | hinge camp mounting pos. bottom left L 100mm W 48mm H 17mm zinc die cast, chrome-plated   |                 |                        |
| <b>For models:</b>  | FMP-117-R, FMP-150, FMP-169-R, FMP-200, FMP-222-R, FMP-250, FMP-274-R, FMP-300, MEP-100, MEP-100G, MEP-135, MEP-180, MFN-135, MFN-180, MFP-102-GN-R, MFP-135-F-GN, MFP-135-GN, MFP-147-GN-R, MFP-180-F-GN, MFP-180-GN, MFP-192-GN-R, MFP-225-F-GN, MFP-225-GN, MFP-237-GN-R, MFP-270-F-GN, MFP-270-GN, MPP-150, MPP-202, MPP-255, MPP-307, MPZ1-150, MPZ1-200, MPZ1-250, MSN-150, MSN-200, MSP-117-2RC, MSP-117-R, MSP-150, MSP-150-2C, MSP-150-F, MSP-169-R, MSP-169-R2C, MSP-169-R4C, MSP-200, MSP-200-2C, MSP-200-4C, MSP-200-F, MSP-222-R, MSP-222-R4C, MSP-222-R6C...(Other models you can see in the webshop) |                 |                        |

Зип Общепит

vsezip.ru

+7(812)987-08-81



1

|  |  |                 |  |
|--|--|-----------------|--|
| <b>GEV No.</b>   | 700830   | <b>Ref. No.</b> | 12031972<br>12034927<br>12058528<br>6000300007<br>6009991521<br>6033010003<br>6033010030 |
| <b>description</b>   | spring assisted hinge right/left L 75mm W 26mm H 102mm refrigeration units mounting distance 25mm  |                 |  |
| <b>For models:</b>   | AEP-1402, AEP-1403, AEP-1404, AEP-1602, AEP-1603, AEP-1604, AEP-2103, AEP-701, AEP-702, AEP-801, AEP-802, AF-1402-MIX, AF-1403-C, AF-1403-P, AF-1404-C, AF-1404-P, AF-1602-MIX, AF-1603-C, AF-1603-P, AF-1604-C, AF-1604-P, AF-2104-C, AF-2104-P, AF-2105-C, AF-2105-P, AF-2106-C, AF-2106-P, AF-702-C, AF-702-P, AF-802-C, AF-802-P, AFN-1402, AFN-1403, AFN-1404, AFN-1602, AFN-1603, AFN-1604, AFN-701, AFN-702, AFN-801, AFN-802, AFP-1402, AFP-1402-FORZ, AFP-1402-MIX, AFP-1403, AFP-1403-C, AFP-1403-FORZ, AFP-1403-P, AFP-1404, AFP-1404-C...(Other models you can see in the webshop) |                 |  |
| <b>accessories for</b>   | 700830   |                 |  |
|  | <b>GEV No.</b>   | 700854          | <b>Ref. No.</b> 12036924<br>6033010084   |
|  | hinge camp type TRB/L1 36mm mounting pos. bottom right L 100mm W 48mm H 17mm zinc die cast, chrome-plated hole distance 6.5x51x28mm shaft diameter torx 12x12mmmm  |                 |  |





1

|                    |  |                 |                     |
|--------------------|--|-----------------|---------------------|
| <b>GEV No.</b>     | 700001   | <b>Ref. No.</b> | 12008998<br>U010512 |
| <b>description</b> | opposite support L 118mm W 17mm mounting distance 94mm   |                 |                     |
| <b>For models:</b> | CE6-41, CE7-41, CE7-41Q, CE9-41, CE9-41AD, CE9-41PLUS, CG-1002, CG-1502, CG-2000, CG-2000-2P, CG-2002, CG-2002P, CG-210, CG-210G, CG-310, CG-310G, CG6-41, CG7-11, CG-7115, CG7-31D, CG7-31I, CG7-41, CG-7415, CG7-41H, CG7-51, CG7-61, CG-7615, CG7-61H, CG9-11, CG9-11AD, CG9-11PLUS, CG9-41, CG9-41AD, CG9-41AD-H, CG9-41H, CG9-41PLUS, CG9-41PLUS-H, CG9-51L, CG9-51LC, CG9-51R, CG9-51RC, CG9-61, CG9-61AD, CG9-61AD-H, CG9-61H, CG9-61OP, CG9-61PLUS, CG9-61PLUS-H, CG9-82, CG9-82AD...(Other models you can see in the webshop) |                 |                     |



1

|   |  |                 |                                     |
|---|--|-----------------|-------------------------------------|
| <b>GEV No.</b>  | 700006   | <b>Ref. No.</b> | 12019715<br>U010504                 |
| <b>description</b>  | oven hinge mounting distance 173mm mounting distance 2 105mm lug mounting 14mm lever length 120mm groove distance 11mm spring thickness 3.5mm mounting ear position left spring length 112mm W 25mm  |                 |                                     |
| <b>For models:</b>  | CE7-41, CE9-41, CG-1002, CG-1502, CG-2000, CG-2000-2P, CG-2002, CG-210, CG-210G, CG-310, CG-310G, CG7-11, CG-7115, CG7-41, CG-7415, CG7-61, CG-7615, CG9-11, CG9-41, CG9-51L, CG9-51LC, CG9-51R, CG9-51RC, CG9-61, CG9-82, CGE7-194, CGE7-41, CGE9-41, CGF9-121D, CGF9-121I, FTG9-11L, FTG9-11L+R, FTG9-11R, FTGC9-11L, FTGC9-11L+R, FTGC9-11R, HE9-10, HE9-20, HG9-10, HG9-20 |                 |                                     |
| <b>accessories for</b>  | 700006   |                 |                                     |
|  | <b>GEV No.</b>   | 700001          | <b>Ref. No.</b> 12008998<br>U010512 |
|   | opposite support L 118mm W 17mm mounting distance 94mm   |                 |                                     |
|  | <b>GEV No.</b>   | 700007          | <b>Ref. No.</b> 12019714<br>U010511 |
|   | oven hinge mounting distance 173mm mounting distance 2 105mm lug mounting 14mm lever length 120mm groove distance 11mm spring thickness 3.5mm mounting ear position right spring length 112mm W 25mm   |                 |                                     |

oven hinges



1

|                    |  |                 |                     |
|--------------------|--|-----------------|---------------------|
| <b>GEV No.</b>     | 691003   | <b>Ref. No.</b> | 12002123<br>U010510 |
| <b>description</b> | guide L 128mm W 26mm thickness 1mm cut-out 7x41 7x22.5mm for hinge   |                 |                     |
| <b>For models:</b> | CE7-41, CE9-41, CG-1002, CG-1502, CG-2000, CG-2000-2P, CG-2002, CG-2002P, CG-210, CG-210G, CG-310, CG-310G, CG7-11, CG-7115, CG7-41, CG-7415, CG7-61, CG-7615, CG9-11, CG9-41, CG9-51L, CG9-51LC, CG9-51R, CG9-51RC, CG9-61, CG9-82, CGE7-195, CGE7-41, CGE9-41, CGF9-121D, CGF9-121I, FTG9-11L, FTG9-11L+R, FTG9-11R, FTGC9-11L, FTGC9-11L+R, FTGC9-11R, HE9-10, HE9-20, HG9-10, HG9-20 |                 |                     |

Zip Общепит

door bearing

vsezip.ru

+7(812)987-08-81

**1**

|                        |  |                 |                     |
|------------------------|--|-----------------|---------------------|
| <b>GEV No.</b>         | 700007   | <b>Ref. No.</b> | 12019714<br>U010511 |
| <b>description</b>     | oven hinge mounting distance 173mm mounting distance 2 105mm lug mounting 14mm lever length 120mm groove distance 11mm spring thickness 3.5mm mounting ear position right spring length 112mm W 25mm   |                 |                     |
| <b>For models:</b>     | CE7-41, CE9-41, CG-1002, CG-1502, CG-2000, CG-2000-2P, CG-2002, CG-210, CG-210G, CG-310, CG-310G, CG7-11, CG-7115, CG7-41, CG-7415, CG7-61, CG-7615, CG9-11, CG9-41, CG9-51L, CG9-51LC, CG9-51R, CG9-51RC, CG9-61, CG9-82, CGE7-193, CGE7-41, CGE9-41, CGF9-121D, CGF9-121I, FTG9-11L, FTG9-11L+R, FTG9-11R, FTGC9-11L, FTGC9-11L+R, FTGC9-11R, HE9-10, HE9-20, HG9-10, HG9-20 |                 |                     |
| <b>accessories for</b> | 700007   |                 |                     |
|                        | <b>GEV No.</b>   | 700001          | <b>Ref. No.</b>     |
|                        |  |                 | 12008998<br>U010512 |
|                        | opposite support L 118mm W 17mm mounting distance 94mm   |                 |                     |

**1**

|                        |   |                 |                     |
|------------------------|---|-----------------|---------------------|
| <b>GEV No.</b>         | 700820  | <b>Ref. No.</b> | 12009225<br>U020528 |
| <b>description</b>     | oven hinge mounting distance 173mm mounting distance 2mm lug mounting 14mm lever length 119mm groove distance 11mm spring thickness 3.5mm mounting ear position left/right spring length 112mm L 207mm W 25mm   |                 |                     |
| <b>For models:</b>     | CE6-41, CE7-41, CE7-41Q, CE9-41, CE9-41AD, CE9-41PLUS, CG-1002, CG-1502, CG-2002, CG-2002P, CG-210, CG-210G, CG-310, CG-310G, CG6-41, CG7-11, CG7-31D, CG7-31I, CG7-41, CG7-41H, CG7-51, CG7-61, CG7-61H, CG9-11, CG9-11AD, CG9-11PLUS, CG9-31PLUS-D, CG9-31PLUS-I, CG9-41, CG9-41AD, CG9-41AD-H, CG9-41H, CG9-41PLUS, CG9-41PLUS-H, CG9-51L, CG9-51LC, CG9-51R, CG9-51RC, CG9-61, CG9-61AD, CG9-61AD-H, CG9-61H, CG9-61OP, CG9-61PLUS, CG9-61PLUS-H, CG9-82, CG9-82AD, CG9-82PLUS, CGE6-41, CGE7-41... (Other models you can see in the webshop) |                 |                     |
| <b>accessories for</b> | 700820  |                 |                     |
|                        | <b>GEV No.</b>  | 700001          | <b>Ref. No.</b>     |
|                        |   |                 | 12008998<br>U010512 |
|                        | opposite support L 118mm W 17mm mounting distance 94mm  |                 |                     |

**1**

|                    |                          |                 |                        |
|--------------------|--------------------------|-----------------|------------------------|
| <b>GEV No.</b>     | 693569                   | <b>Ref. No.</b> | 12034578<br>RT21201254 |
| <b>description</b> | bolt mounting pos. upper |                 |                        |

**1**

|                    |                          |                 |                        |
|--------------------|--------------------------|-----------------|------------------------|
| <b>GEV No.</b>     | 693568                   | <b>Ref. No.</b> | 12032516<br>RT29401300 |
| <b>description</b> | bush mounting pos. upper |                 |                        |

**1**

|                        |  |                 |                        |
|------------------------|--|-----------------|------------------------|
| <b>GEV No.</b>         | 690764   | <b>Ref. No.</b> | 12037723<br>6003010136 |
| <b>description</b>     | bush W 23.5mm H 53.5mm mounting pos. upper/lower ø 16mm ID ø 10mm grey for hinge   |                 |                        |
| <b>For models:</b>     | ADMEN-135, ADMEN-180, ADMEN-225, ADMCP-135, ADMCP-180, ADMCP-225, ADMFN-135, ADMFN-180, ADMFN-225, ADMFP-135, ADMFP-135-GR, ADMFP-135HD, ADMFP-135PC, ADMFP-180, ADMFP-180-GR, ADMFP-180HDD, ADMFP-180HHD, ADMFP-180PC, ADMFP-225, ADMFP-225-GR, ADMFP-225HDD, ADMFP-225HHD, ADMFP-225HHDD, ADMFP-225PC, AEP-1402, AEP-1602, AEP-2103, AEP-701, AEP-801, AEP-802, AF-1402-MIX, AF-1403-C, AF-1403-P, AF-1404-C, AF-1404-P, AF-1602-MIX, AF-1603-C, AF-1603-P, AF-1604-C, AF-1604-P, AF-2104-C, AF-2104-P, AF-2105-C, AF-2105-P, AF-2106-C, AF-2106-P, AF-702-C, AF-702-P, AF-802-C, AF-802-P...(Other models you can see in the webshop) |                 |                        |
| <b>accessories for</b> | 690764   |                 |                        |
|                        | <b>GEV No.</b>   | 700817          | <b>Ref. No.</b>        |
|                        |  |                 | 12038076<br>6033090064 |
|                        | hinge bolt upper ø 10mm L 30mm IT M6 for refrigerated counters mounting pos. upper   |                 |                        |

**1**

|                    |   |                 |                     |
|--------------------|---|-----------------|---------------------|
| <b>GEV No.</b>     | 691647  | <b>Ref. No.</b> | 12024596<br>T130500 |
| <b>description</b> | door hinge L 156mm W 50mm mounting pos. upper right thickness 6mm   |                 |                     |
| <b>For models:</b> | COE-061, COE-101, COG-061, COG-101, HCG-10-11, HCG-10-21, HCG-20-11, HCG-20-21, HCG-2-10-11, HCG-2-20-11, HCG-6-11, HEI-10-11, HEI-6-11, HEM-10-11, HEM-6-11, HEP-10-11, HEP-6-11, HGC-10-11, HGC-6-11, HGV-10-11, HME-10-11, HME-10-21, HME-20-11, HME-20-21, HME-2-10-11, HME-2-20-11, HME-6-11, HMI-10-11, HMI-10-11UL, HMI-10-21, HMI-10-21UL, HMI-2-10-11, HMI-6-11, HMI-6-11UL, HMM-10-11, HMM-10-11UL, HMM-10-21, HMM-10-21UL, HMM-20-11, HMM-20-11UL, HMM-20-21, HMM-20-21UL, HMM-2-10-11, HMM-2-20-11, HMM-40-11-USMC, HMM-6-11, HMM-6-11UL, HMP-10-11, HMP-10-21, HMP-20-11...(Other models you can see in the webshop) |                 |                     |

Зип Общепит

vsezip.ru

+7(812)987-08-81

|   |  |                 |                     |
|---|--|-----------------|---------------------|
|  |  |                 |                     |
| 1   |  |                 |                     |
| <b>GEV No.</b>  | 700835   | <b>Ref. No.</b> | 12011159<br>U060515 |
| <b>description</b>  | door hinge L 96mm W 33mm H 44mm mounting pos. left upper |                 |                     |
| <b>For models:</b>  | CGB7-61  |                 |                     |

|   |   |                 |                     |
|---|---|-----------------|---------------------|
|  |   |                 |                     |
| 1   |   |                 |                     |
| <b>GEV No.</b>  | 700834  | <b>Ref. No.</b> | 12015573<br>U060514 |
| <b>description</b>  | door hinge L 96mm W 33mm H 44mm mounting pos. right upper |                 |                     |
| <b>For models:</b>  | CGB7-61   |                 |                     |

|  |   |                 |                        |
|--|---|-----------------|------------------------|
|  |   |                 |                        |
| 1  |   |                 |                        |
| <b>GEV No.</b>   | 692297  | <b>Ref. No.</b> | 12036829<br>6033010111 |
| <b>description</b>   | hinge L 100mm W 17mm H 48mm mounting pos. bottom left thickness 5mm   |                 |                        |
| <b>For models:</b>   | AEP-1402, AEP-1602, AEP-2103, AF-1402-MIX, AF-1403-C, AF-1403-P, AF-1404-C, AF-1404-P, AF-1602-MIX, AF-1603-C, AF-1603-P, AF-1604-C, AF-1604-P, AF-2104-C, AF-2104-P, AF-2105-C, AF-2105-P, AF-2106-C, AF-2106-P, AFN-1402, AFN-1403, AFN-1404, AFN-1602, AFN-1603, AFN-1604, AFP-1402, AFP-1403, AFP-1404, AFP-1602, AFP-1602-2, AFP-1603, AFP-1603-2, AFP-1604, AFP-2103, AFP-2104, AFP-2105, AFP-2106, ERM-150, ERM-250, ERM-350 |                 |                        |

|   |  |                 |                        |
|---|--|-----------------|------------------------|
|  |  |                 |                        |
| 1   |  |                 |                        |
| <b>GEV No.</b>  | 691738   | <b>Ref. No.</b> | 12038085<br>6033010098 |
| <b>description</b>  | hinge L 100mm W 48mm mounting pos. left thickness 5mm for door for refrigerated counters   |                 |                        |
| <b>For models:</b>  | AEP-2103, AF-2104-C, AF-2104-P, AF-2105-C, AF-2105-P, AF-2106-C, AF-2106-P, AFP-2103, AFP-2104, AFP-2105, AFP-2106, FMP-117-R, FMP-150, FMP-169-R, FMP-200, FMP-222-R, FMP-250, FMP-274-R, FMP-300, MCP-135-GN, MCP-147-GN-R, MCP-180-GN, MCP-225-GN, MCP-270-GN, MEP-100, MEP-100G, MEP-135, MEP-180, MFN-135, MFN-180, MFP-102-GN-R, MFP-135-F-GN, MFP-135-GN, MFP-147-GN-R, MFP-180-F-GN, MFP-180-GN, MFP-192-GN-R, MFP-225-F-GN, MFP-225-GN, MFP-237-GN-R, MFP-270-F-GN, MFP-270-GN, MPP-150, MPP-202, MPP-255, MPP-307, MPZ1-150, MPZ1-200, MPZ1-250, MSN-150...(Other models you can see in the webshop) |                 |                        |

|  |   |                 |                                     |
|--|---|-----------------|-------------------------------------|
|  |   |                 |                                     |
| 1  |   |                 |                                     |
| <b>GEV No.</b>   | 691737  | <b>Ref. No.</b> | 12037938<br>6033010099<br>M19090004 |
| <b>description</b>   | hinge L 100mm W 48mm mounting pos. right thickness 5mm for door for refrigerated counters   |                 |                                     |
| <b>For models:</b>   | AEP-2103, AF-2104-C, AF-2104-P, AF-2105-C, AF-2105-P, AF-2106-C, AF-2106-P, AFP-2103, AFP-2104, AFP-2105, AFP-2106, MCP-135-GN, MCP-147-GN-R, MCP-180-GN, MCP-225-GN, MCP-270-GN, MEP-100, MEP-100G, MSP-150-GI, MSP-200-GI, MSP-250-GI, MSP-300-GI |                 |                                     |



|  |   |                 |                        |
|--|---|-----------------|------------------------|
|  |   |                 |                        |
| 1  |   |                 |                        |
| <b>GEV No.</b>   | 690765  | <b>Ref. No.</b> | 12037372<br>6033090090 |
| <b>description</b>   | hinge L 47mm H 20mm mounting pos. bottom right ø 10mm   |                 |                        |
| <b>For models:</b>   | ADMCN-135, ADMCN-180, ADMCN-225, ADMCP-135, ADMCP-180, ADMCP-225, ADMFN-135, ADMFN-180, ADMFN-225, ADMFP-135, ADMFP-135-GR, ADMFP-135HD, ADMFP-135HH, ADMFP-135PC, ADMFP-180, ADMFP-180-GR, ADMFP-180HDD, ADMFP-180HHD, ADMFP-180HHH, ADMFP-180PC, ADMFP-225, ADMFP-225-GR, ADMFP-225HDD, ADMFP-225HDD, ADMFP-225HHHD, ADMFP-225HHHH, ADMFP-225PC, CFMP-150, CFMP-150F, CFMP-150PC, CFMP-150TV, CFMP-202, CFMP-202F, CFMP-202PC, CFMP-202TV, CFMP-255, CFMP-255F, CFMP-255PC, CFMP-255TV, CFMP-307, CFMP-307F, CFMP-307TV, CMFN-135, CMFN-180, CMFN-225, CMFN-270, CMFP-135, CMFP-135-B, CMFP-135-B2, CMFP-135-BP...(Other models you can see in the webshop) |                 |                        |

|  |  |                 |  |
|--|--|-----------------|--|
|  |  |                 |  |
| 1  |  |                 |  |
| <b>GEV No.</b>   | 701159   | <b>Ref. No.</b> | 12036086<br>12038111<br>6009992205<br>6009992206 |
| <b>description</b>   | hinge L 50mm W 35mm H 39mm mounting pos. bottom right  |                 |  |
| <b>For models:</b>   | FMP-117-R, FMP-150, FMP-169-R, FMP-200, FMP-222-R, FMP-250, FMP-274-R, FMP-300, MCN-102-GN-R, MCN-135-GN, MCN-147-GN-R, MCN-180-GN, MCN-192-GN-R, MCN-225-GN, MCN-237-GN-R, MCN-270-GN, MCP-102-GN-R, MCP-135-GN, MCP-147-GN-R, MCP-180-GN, MCP-192-GN-R, MCP-225-GN, MCP-237-GN-R, MCP-270-GN, MEP-100, MEP-135, MEP-180, MFN-102-GN-R, MFN-135-GN, MFN-147-GN-R, MFN-180-GN, MFN-192-GN-R, MFN-225-GN, MFN-237-GN-R, MFP-270-GN, MFP-102-GN-R, MFP-135-GN, MFP-147-GN-R, MFP-180-GN, MFP-192-GN-R, MFP-225-GN, MFP-237-GN-R, MFP-270-GN, MPN-117-R, MPN-117-R-C, MPN-150, MPN-150-C, MPN-169-R, MPN-169-R-C, MPN-202...(Other models you can see in the webshop) |                 |  |



Зип Общепит  
vsezip.ru

812)98708-81

|   |  |                 |   |
|---|--|-----------------|---|
|  |  |                 |   |
| <b>GEV No.</b>  | 701157   | <b>Ref. No.</b> | 12035983<br>12036087<br>600992203<br>V169090002 |
| <b>description</b>  | hinge L 50mm W 36mm H 30mm mounting pos. left/upper and bottom kit   |                 |   |
| <b>For models:</b>  | FMP-117-R, FMP-150, FMP-169-R, FMP-200, FMP-222-R, FMP-250, FMP-274-R, FMP-300, MCN-102-GN-R, MCN-102-R, MCN-135, MCN-135-GN, MCN-147-GN-R, MCN-147-R, MCN-180, MCN-180-GN, MCN-192-GN-R, MCN-192-R, MCN-225, MCN-225-GN, MCN-237-GN-R, MCN-237-R, MCN-270, MCN-270-GN, MCP-102-GN-R, MCP-135, MCP-135-GN, MCP-147-GN-R, MCP-180, MCP-180-GN, MCP-192-GN-R, MCP-225, MCP-225-GN, MCP-237-GN-R, MCP-270-GN, MEP-100, MEP-100G, MEP-135, MEP-180, MFN-102-GN-R, MFN-135-GN, MFN-147-GN-R, MFN-180-GN, MFN-192-GN-R, MFN-225-GN, MFN-237-GN-R, MFN-270-GN, MFP-102-GN-R, MFP-135-GN, MFP-147-GN-R...(Other models you can see in the webshop) |                 |   |
| <b>accessories for</b>  | 701157   |                 |   |
|   |   | <b>GEV No.</b>  | 690764  |
|   |  | <b>Ref. No.</b> | 12037723<br>6003010136                          |
|   | bush W 23.5mm H 53.5mm mounting pos. upper/lower ø 16mm ID ø 10mm grey for hinge   |                 |   |

|                    |  |                 |          |
|--------------------|--|-----------------|----------|
| <b>GEV No.</b>     | 692903   | <b>Ref. No.</b> | 12047967 |
| <b>description</b> | hinge L 54mm W 32mm H 12.5mm mounting pos. lower thread M6 ID ø 15.5mm   |                 |          |
| <b>For models:</b> | ACE-061, ACE-101, ACE-102, ACE-201, ACE-202, ACG-061, ACG-101, ACG-102, ACG-201, ACG-202, AE-061, AE-061W, AE-101, AE-101W, AE-102, AE-102W, AE-201, AE-202, AG-061, AG-061W, AG-101, AG-101W, AG-102, AG-102W, AG-201, AG-202, APE-061, APE-061W, APE-101, APE-101W, APE-102, APE-102W, APE-201, APE-202, APG-061, APG-061W, APG-101, APG-101W, APG-102, APG-102W, APG-201, APG-202 |                 |          |

|  |  |                 |                     |
|--|--|-----------------|---------------------|
|  |  |                 |                     |
| <b>GEV No.</b>   | 691728   | <b>Ref. No.</b> | 12014955<br>E022608 |
| <b>description</b>   | hinge L 85mm W 66mm thickness 2.5mm L-shape for fryer  |                 |                     |
| <b>For models:</b>   | CG7-61, CG9-51L, CG9-51LC, CG9-51R, CG9-51RC, CG9-61, CPG7-05, CPG9-05, CPG9-05NC, FE-710, FE-720, FE9-05, FE9-05USMC, FE9-10, FG-710, FG-720, FG9-05, FG9-10, MB7-05, MB7-10, MB9-05-PUERTA-DCHA, MB9-10-PUERTA-DOBLE, MB9-15-PUERTA-DCHA, MB9-15-PUERTA-IZDA |                 |                     |

|  |  |                 |                        |
|--|--|-----------------|------------------------|
|  |  |                 |                        |
| <b>GEV No.</b>   | 701160   | <b>Ref. No.</b> | 12036087<br>6009992204 |
| <b>description</b>   | hinge L 51mm W 36mm H 40mm mounting pos. bottom left   |                 |                        |
| <b>For models:</b>   | FMP-117-R, FMP-150, FMP-169-R, FMP-200, FMP-222-R, FMP-250, FMP-274-R, FMP-300, MCN-102-GN-R, MCN-135-GN, MCN-147-GN-R, MCN-180-GN, MCN-192-GN-R, MCN-225-GN, MCN-237-GN-R, MCN-270-GN, MCP-102-GN-R, MCP-135-GN, MCP-147-GN-R, MCP-180-GN, MCP-192-GN-R, MCP-225-GN, MCP-237-GN-R, MCP-270-GN, MEP-100, MEP-135, MEP-180, MFN-102-GN-R, MFN-135-GN, MFN-147-GN-R, MFN-180-GN, MFN-192-GN-R, MFN-225-GN, MFN-237-GN-R, MFN-270-GN, MFP-102-GN-R, MFP-135-GN, MFP-147-GN-R, MFP-180-GN, MFP-192-GN-R, MFP-225-GN, MFP-237-GN-R, MFP-270-GN, MMZ-202, MPN-117-R, MPN-117-R-C, MPN-150, MPN-150-C, MPN-169-R, MPN-169-R-C...(Other models you can see in the webshop) |                 |                        |

|   |   |                 |                        |
|---|---|-----------------|------------------------|
|  |   |                 |                        |
| <b>GEV No.</b>  | 700812  | <b>Ref. No.</b> | 12037672<br>6003010048 |
| <b>description</b>  | hinge mounting distance 12mm mounting pos. upper and bottom for technical chamber door for refrigerated counters shaft ø 9mm  |                 |                        |
| <b>For models:</b>  | FMP-150, FMP-202, FMP-255, FMP-307, MCN-135, MCN-180, MCN-225, MCN-270, MCP-135, MCP-135-GN, MCP-180, MCP-180-GN, MCP-225, MCP-225-GN, MCP-270-GN, MEP-135, MEP-180, MFN-135, MFN-180, MFN-225, MFN-270, MFP-135, MFP-135-2C, MFP-135-4C, MFP-135-F, MFP-180, MFP-180-2C, MFP-180-4C, MFP-180-6C, MFP-180-F, MFP-225, MFP-225-2C, MFP-225-4C, MFP-225-6C, MFP-225-8C, MFP-225-F, MFP-270-10C, MFP-270-2C, MFP-270-4C, MFP-270-6C, MFP-270-8C, MFP-270-F, MMZ-150, MMZ-202, MPN-150, MPN-150-C, MPN-202, MPN-202-C, MPN-255, MPN-255-C...(Other models you can see in the webshop) |                 |                        |

|   |  |                 |                        |
|---|--|-----------------|------------------------|
|  |  |                 |                        |
| <b>GEV No.</b>  | 692904   | <b>Ref. No.</b> | 12039311<br>T540565000 |
| <b>description</b>  | hinge L 54mm W 32mm H 10mm mounting pos. lower thread M6 ID ø 15.5mm   |                 |                        |
| <b>For models:</b>  | ACE-061, ACE-101, ACE-102, ACE-201, ACE-202, ACG-061, ACG-101, ACG-102, ACG-201, ACG-202, AE-061, AE-101, AE-102, AE-201, AE-202, AG-061, AG-101, AG-102, AG-201, AG-202, APE-061, APE-101, APE-102, APE-201, APE-202, APG-061, APG-101, APG-102, APG-201, APG-202 |                 |                        |

|  |  |                 |                                      |
|--|--|-----------------|--------------------------------------|
|  |  |                 |                                      |
| <b>GEV No.</b>   | 700890   | <b>Ref. No.</b> | 12038100<br>6009992202<br>V169090001 |
| <b>description</b>   | hinge mounting pos. left/upper and bottom  |                 |                                      |
| <b>For models:</b>   | EC-150, ECC-150, FMP-117-R, FMP-150, FMP-169-R, FMP-202, FMP-222-R, FMP-255, FMP-274-R, FMP-307, MCN-102-R, MCN-135, MCN-147-R, MCN-180, MCN-192-R, MCN-225, MCN-237-R, MCN-270, MCP-135, MCP-180, MCP-225, MEP-100, MEP-100G, MEP-135, MEP-180, MFN-102-R, MFN-135, MFN-147-R, MFN-180, MFN-192-R, MFN-225, MFN-237-R, MFN-270, MFP-102-2C, MFP-135, MFP-135-2C, MFP-135-F, MFP-147-2C, MFP-147-4C, MFP-180, MFP-180-2C, MFP-180-4C, MFP-180-F, MFP-192-2C, MFP-192-4C, MFP-192-6C, MFP-225, MFP-225-2C, MFP-225-4C, MFP-225-6C...(Other models you can see in the webshop) |                 |                                      |

Зип Общепит

vsezip.ru

+7(812)987-9881

|   |                           |                 |                        |
|---|---------------------------|-----------------|------------------------|
|  |                           |                 |                        |
| 1   |                           |                 |                        |
| <b>GEV No.</b>  | 693567                    | <b>Ref. No.</b> | 12031970<br>RT29301307 |
| <b>description</b>  | hinge mounting pos. upper |                 |                        |

|   |  |                 |                        |
|---|--|-----------------|------------------------|
|  |  |                 |                        |
| 1   |  |                 |                        |
| <b>GEV No.</b>  | 521285   | <b>Ref. No.</b> | 12039312<br>T540566000 |
| <b>description</b>  | hinge bearing L 152mm W 29mm H 8.5mm mounting pos. upper without bolt  |                 |                        |
| <b>For models:</b>  | ACE-061, ACE-101, ACE-102, ACE-201, ACE-202, ACG-061, ACG-101, ACG-102, ACG-201, ACG-202, AE-061, AE-061W, AE-101, AE-101W, AE-102, AE-102W, AE-201, AE-202, AG-061, AG-061W, AG-101, AG-101W, AG-102, AG-102W, AG-201, AG-202, APE-061, APE-061W, APE-101, APE-101W, APE-102, APE-102W, APE-201, APE-202, APG-061, APG-061W, APG-101, APG-101W, APG-102, APG-102W, APG-201, APG-202 |                 |                        |

|   |  |                 |                                |
|---|--|-----------------|--------------------------------|
|  |  |                 |                                |
| 1   |  |                 |                                |
| <b>GEV No.</b>  | 691091   | <b>Ref. No.</b> | 12024517<br>R660507<br>R660551 |
| <b>description</b>  | hinge bearing mounting pos. lower without bolt   |                 |                                |
| <b>For models:</b>  | COE-061, COE-101, COG-061, COG-101, HCG-10-11, HCG-10-21, HCG-20-11, HCG-20-21, HCG-2-10-11, HCG-2-20-11, HCG-6-11, HME-10-11, HME-10-21, HME-20-11, HME-20-21, HME-2-10-11, HME-2-20-11, HME-6-11, HMG-10-11, HMG-10-11UL, HMG-10-21, HMG-10-21UL, HMG-20-11, HMG-2-10-11, HMG-6-11, HMI-10-11, HMI-10-11UL, HMI-10-21, HMI-10-21UL, HMI-2-10-11, HMI-6-11, HMI-6-11UL, HMM-10-11, HMM-10-11UL, HMM-10-21, HMM-10-21UL, HMM-20-11, HMM-20-11UL, HMM-20-21, HMM-20-21UL, HMM-2-10-11, HMM-2-20-11, HMM-40-11-USMC, HMM-6-11, HMM-6-11UL, HMP-10-11, HMP-10-21, HMP-20-11, HMP-20-21, HMP-2-10-11...(Other models you can see in the webshop) |                 |                                |

|   |   |                 |                                |
|---|---|-----------------|--------------------------------|
|  |   |                 |                                |
| 1   |   |                 |                                |
| <b>GEV No.</b>  | 691088  | <b>Ref. No.</b> | 12020438<br>R660517<br>R660550 |
| <b>description</b>  | hinge bearing mounting pos. upper right without bolt  |                 |                                |
| <b>For models:</b>  | HCG-10-11, HCG-10-21, HCG-20-11, HCG-2-10-11, HCG-6-11, HME-10-11, HME-10-21, HME-20-11, HME-20-21, HME-2-10-11, HME-6-11, HMG-10-11, HMG-10-11UL, HMG-10-21, HMG-10-21UL, HMG-20-11, HMG-2-10-11, HMG-6-11, HMI-10-11, HMI-10-11UL, HMI-10-21, HMI-10-21UL, HMI-2-10-11, HMI-6-11, HMI-6-11UL, HMM-10-11, HMM-10-11UL, HMM-10-21, HMM-10-21UL, HMM-20-11, HMM-20-11UL, HMM-20-21, HMM-2-10-11, HMM-6-11, HMM-6-11UL, HMP-10-11, HMP-10-21, HMP-20-11, HMP-20-21, HMP-2-10-11, HMP-6-11 |                 |                                |

|  |  |                 |                        |
|--|--|-----------------|------------------------|
|  |  |                 |                        |
| 1  |  |                 |                        |
| <b>GEV No.</b>   | 701161   | <b>Ref. No.</b> | 12037017<br>6033010130 |
| <b>description</b>   | hinge camp mounting pos. bottom right L 100mm W 48mm H 17mm shaft diameter M6mm  |                 |                        |
| <b>For models:</b>   | ADAEP-1602, ADAFN-1602, ADAFP-1602, ADMCN-135, ADMCN-180, ADMCN-225, ADMCP-135, ADMCP-180, ADMCP-225, AEP-1402, AEP-1602, AEP-1602AD, AEP-1603AD, AEP-1604AD, AEP-2103, AF-1402-MIX, AF-1403-C, AF-1403-P, AF-1404-C, AF-1404-P, AF-1602-MIX, AF-1603-C, AF-1603-P, AF-1604-C, AF-1604-P, AF-2104-C, AF-2104-P, AF-2105-C, AF-2105-P, AF-2106-C, AF-2106-P, AFN-1402, AFN-1403, AFN-1404, AFN-1602, AFN-1603, AFN-1604, AFP-1402, AFP-1403, AFP-1404, AFP-1602, AFP-1602-2, AFP-1603, AFP-1603-2, AFP-1604, AFP-2103, AFP-2104, AFP-2105, AFP-2106, ANF-1602AD...(Other models you can see in the webshop) |                 |                        |

|  |   |                 |                        |
|--|---|-----------------|------------------------|
|  |   |                 |                        |
| 1  |   |                 |                        |
| <b>GEV No.</b>   | 701162  | <b>Ref. No.</b> | 12041472<br>6033010140 |
| <b>description</b>   | hinge camp mounting pos. upper right L 100mm W 48mm H 17mm shaft diameter M6mm  |                 |                        |
| <b>For models:</b>   | ADAEP-1602, ADAFN-1602, ADAFP-1602, AEP-1402, AEP-1602, AEP-1602AD, AEP-1603AD, AEP-1604AD, AEP-2103, AF-1402-MIX, AF-1403-C, AF-1403-P, AF-1404-C, AF-1404-P, AF-1602-MIX, AF-1603-C, AF-1603-P, AF-1604-C, AF-1604-P, AF-2104-C, AF-2104-P, AF-2105-C, AF-2105-P, AF-2106-C, AF-2106-P, AFN-1402, AFN-1403, AFN-1404, AFN-1602, AFN-1603, AFN-1604, AFP-1402, AFP-1403, AFP-1404, AFP-1602, AFP-1602-2, AFP-1603, AFP-1603-2, AFP-1604, AFP-2103, AFP-2104, AFP-2105, AFP-2106, ANF-1602AD, ANF-1603AD, ANF-1604AD, APF-1602AD, APF-1603AD, APF-1604AD, CAEP-1402...(Other models you can see in the webshop) |                 |                        |

|  |   |                 |                        |
|--|---|-----------------|------------------------|
|  |   |                 |                        |
| 1  |   |                 |                        |
| <b>GEV No.</b>   | 700854  | <b>Ref. No.</b> | 12036924<br>6033010084 |
| <b>description</b>   | hinge camp type TRB/L1 36mm mounting pos. bottom right L 100mm W 48mm H 17mm zinc die cast, chrome-plated hole distance 6.5x51x28mm shaft diameter torx 12x12mmmm |                 |                        |
| <b>For models:</b>   | ATM-051, ATM-101, ATM-102   |                 |                        |

|  |  |                 |                        |
|--|--|-----------------|------------------------|
|  |  |                 |                        |
| 1  |  |                 |                        |
| <b>GEV No.</b>   | 700855   | <b>Ref. No.</b> | 12036932<br>6033010083 |
| <b>description</b>   | hinge camp type TRB/R1 36mm mounting pos. bottom left L 100mm W 48mm H 17mm zinc die cast, chrome-plated hole distance 6.5x51x28mm shaft diameter torx 12x12mmmm |                 |                        |
| <b>For models:</b>   | AEP-1402, AEP-701, AF-1403-C, AF-1404-C, AF-702-C, AF-702-P, AFN-702, AFP-1402, AFP-1403, AFP-1404, AFP-701, AFP-702, AP-701, APP-701                            |                 |                        |



Зип Общепит  
accessories

shafts  
vsezip.ru

+7(812)987-08-81

1 

|                    |  |                 |                     |
|--------------------|--|-----------------|---------------------|
| <b>GEV No.</b>     | 691089   | <b>Ref. No.</b> | 12023636<br>R660534 |
| <b>description</b> | hinge pin  |                 |                     |
| <b>For models:</b> | ACE-061, ACE-101, ACE-102, ACE-201, ACE-202, ACG-061, ACG-101, ACG-102, ACG-201, ACG-202, AE-061, AE-061W, AE-101, AE-101W, AE-102, AE-102W, AE-201, AE-202, AG-061, AG-061W, AG-101, AG-101W, AG-102, AG-102W, AG-201, AG-202, APE-061, APE-061W, APE-101, APE-101W, APE-102, APE-102W, APE-201, APE-202, APG-061, APG-061W, APG-101, APG-101W, APG-102, APG-102W, APG-201, APG-202, COE-061, COE-101, COE-102, COE-201, COE-202, COG-061, COG-101, COG-102...(Other models you can see in the webshop) |                 |                     |

2 

|                    |   |                 |                     |
|--------------------|---|-----------------|---------------------|
| <b>GEV No.</b>     | 691093  | <b>Ref. No.</b> | 12018292<br>R660504 |
| <b>description</b> | hinge pin   |                 |                     |
| <b>For models:</b> | HCG-10-11, HCG-10-21, HCG-20-11, HCG-2-10-11, HCG-6-11, HME-10-11, HME-10-21, HME-20-11, HME-20-21, HME-2-10-11, HME-6-11, HMG-10-11, HMG-10-11UL, HMG-10-21, HMG-10-21UL, HMG-20-11, HMG-2-10-11, HMG-6-11, HMI-10-11, HMI-10-11UL, HMI-10-21, HMI-10-21UL, HMI-2-10-11, HMI-6-11, HMI-6-11UL, HMM-10-11, HMM-10-11UL, HMM-10-21, HMM-10-21UL, HMM-20-11, HMM-20-11UL, HMM-20-21, HMM-2-10-11, HMM-6-11, HMM-6-11UL, HMP-10-11, HMP-10-21, HMP-20-11, HMP-20-21, HMP-2-10-11, HMP-6-11 |                 |                     |

miscellaneous

1 

|                    |   |                 |                        |
|--------------------|---|-----------------|------------------------|
| <b>GEV No.</b>     | 691870  | <b>Ref. No.</b> | 12036878<br>A169090001 |
| <b>description</b> | hinge L 130mm W 60mm  |                 |                        |
| <b>For models:</b> | AEP-1602, AF-1403-C, AF-1403-P, AF-1404-C, AF-1404-P, AF-1604-C, AF-1604-P, AF-2104-C, AF-2104-P, AF-2105-C, AF-2105-P, AF-2106-C, AF-2106-P, AF-702-C, AF-702-P, AF-802-C, AF-802-P, AFN-1404, AFN-702, AFN-802, AFP-1404, AFP-1604, AFP-2104, AFP-2105, AFP-2106, AFP-702, AFP-802, AFP-802-2 |                 |                        |

1 

|   |   |                 |                                     |
|---|---|-----------------|-------------------------------------|
| <b>GEV No.</b>  | 700818  | <b>Ref. No.</b> | 12024071<br>Z400516                 |
| <b>description</b>  | hinge bolt L 32mm stainless steel D1 ø 7.8mm D2 ø 12mm  |                 |                                     |
| <b>For models:</b>  | AD-15, AD-15D, AD-20C-UK, AD-21, AD-21B, AD-21BDD, AD-21C, AD-21D, AD-21DD, AD-21W, AD-45BBT, AD-48, AD-48B, AD-48BDD, AD-48C, AD-48D, AD-48DD, AD-48HY, AD-48W, AD-64, AD-64B, AD-64BBT, AD-64BDD, AD-64BTDD, AD-64C, AD-64CW, AD-64D, AD-64DD, AD-64HY, AD-72, AD-72W, EASY-500, EASY-500B, EASY-500DD, EASY-500HP, EASY-500HPWDD, FI-30, FI-30AR, FI-30AR+DD, FI-30B, FI-30B-BT-UK, FI-30-UK, FI-48, FI-48AR, FI-48B, FI-48B-BT-UK, FI-48C, FI-48D, FI-48HY-CLINIC, FI-48W...(Other models you can see in the webshop) |                 |                                     |
| <b>spare parts for</b>  | 700818  |                 |                                     |
|  | <b>GEV No.</b>  | 505005          | <b>Ref. No.</b> 12022324<br>Z400514 |
| door hinge hinge left mounting pos. left  |   |                 |                                     |

1 

|                    |   |                 |                        |
|--------------------|---|-----------------|------------------------|
| <b>GEV No.</b>     | 700817  | <b>Ref. No.</b> | 12038076<br>6033090064 |
| <b>description</b> | hinge bolt upper ø 10mm L 30mm IT M6 for refrigerated counters mounting pos. upper  |                 |                        |
| <b>For models:</b> | AEP-1402, AEP-1602, AEP-2103, AEP-701, AEP-801, AEP-802, AF-1402-MIX, AF-1403-C, AF-1403-P, AF-1404-C, AF-1404-P, AF-1602-MIX, AF-1603-C, AF-1603-P, AF-1604-C, AF-1604-P, AF-2104-C, AF-2104-P, AF-2105-C, AF-2105-P, AF-2106-C, AF-2106-P, AF-702-C, AF-702-P, AF-802-C, AF-802-P, AFN-1402, AFN-1403, AFN-1404, AFN-1602, AFN-1603, AFN-1604, AFN-701, AFN-702, AFN-801, AFN-802, AFP-1402, AFP-1403, AFP-1404, AFP-1602, AFP-1602-2, AFP-1603, AFP-1603-2, AFP-1604, AFP-2103, AFP-2104, AFP-2105, AFP-2106, AFP-701, AFP-702...(Other models you can see in the webshop) |                 |                        |

mounting aids

1 

|                    |  |                 |                     |
|--------------------|--|-----------------|---------------------|
| <b>GEV No.</b>     | 691701   | <b>Ref. No.</b> | 12002537<br>U746501 |
| <b>description</b> | mounting aid for hinge   |                 |                     |
| <b>For models:</b> | CE7-41, CE9-41, CG-1002, CG-1502, CG-2002, CG-2002P, CG-210, CG-210G, CG-310, CG-310G, CG7-11, CG7-41, CG7-61, CG9-11, CG9-41, CG9-51L, CG9-51LC, CG9-51R, CG9-51RC, CG9-61, CG9-82, CGE7-41, CGE9-41, CGF9-121D, CGF9-121I, FTG9-11L, FTG9-11L+R, FTG9-11R, FTGC9-11L, FTGC9-11L+R, FTGC9-11R, HE9-10, HE9-20, HG9-10, HG9-20 |                 |                     |

Зип, Общепит

pullouts  
vsezip.ru

+7(812)987-08-81

miscellaneous



|                    |  |                 |   |
|--------------------|--|-----------------|---|
| 1                  |  |                 |   |
| <b>GEV No.</b>     | 691092   | <b>Ref. No.</b> | 12024304<br>870005941<br>R660531<br>R660549 |
| <b>description</b> | guide for hinge  |                 |   |
| <b>For models:</b> | COE-061, COE-101, COE-102, COE-201, COE-202, COG-061, COG-101, COG-102, COG-201, COG-202, HCG-10-11, HCG-10-21, HCG-20-11, HCG-20-21, HCG-2-10-11, HCG-2-20-11, HCG-6-11, HEI-10-11, HEI-10-21, HEI-20-11, HEI-20-21, HEI-6-11, HEM-10-11, HEM-10-21, HEM-20-11, HEM-20-21, HEM-6-11, HEP-10-11, HEP-10-21, HEP-20-11, HEP-20-21, HEP-6-11, HGC-10-11, HGC-10-21, HGC-20-11, HGC-20-21, HGC-6-11, HGP-10-21, HGP-20-21, HGV-10-11, HGV-10-21, HGV-20-11, HGV-20-21, HME-10-11, HME-10-21, HME-20-11, HME-20-21, HME-2-10-11, HME-2-20-11, HME-6-11...(Other models you can see in the webshop) |                 |   |



|                    |                 |                 |                        |
|--------------------|-----------------|-----------------|------------------------|
| 1                  |                 |                 |                        |
| <b>GEV No.</b>     | 693570          | <b>Ref. No.</b> | 12033778<br>RT29401302 |
| <b>description</b> | sleeve latching |                 |                        |



|                    |                 |                 |                        |
|--------------------|-----------------|-----------------|------------------------|
| 1                  |                 |                 |                        |
| <b>GEV No.</b>     | 693571          | <b>Ref. No.</b> | 12033852<br>RT29401303 |
| <b>description</b> | spigot latching |                 |                        |

drawer slides



|                    |  |                 |                        |
|--------------------|--|-----------------|------------------------|
| 1                  |  |                 |                        |
| <b>GEV No.</b>     | 696478   | <b>Ref. No.</b> | 12031241<br>6033050006 |
| <b>description</b> | drawer slide L 550mm W 17mm H 60mm pair  |                 |                        |
| <b>For models:</b> | AFP-802, AFP-802-2, AFP-802-2C, AFP-802-3C, MFP-102-2C, MFP-102-4C, MFP-102-R2C-GN, MFP-102-R4C-GN, MFP-135-2C, MFP-135-2C-GN, MFP-135-4C, MFP-135-4C-GN, MFP-135-B, MFP-135-B2-GN, MFP-135-B-GN, MFP-147-2C, MFP-147-4C, MFP-147-6C, MFP-147-R2C-GN, MFP-147-R4C-GN, MFP-147-R6C-GN, MFP-180-2C, MFP-180-2C-GN, MFP-180-4C, MFP-180-4C-GN, MFP-180-6C, MFP-180-6C-GN, MFP-180-B, MFP-180-B2-GN, MFP-180-B-GN, MFP-192-2C, MFP-192-4C, MFP-192-6C, MFP-192-8C, MFP-192-R2C-GN, MFP-192-R4C-GN, MFP-192-R6C-GN, MFP-192-R8C-GN, MFP-225-2C, MFP-225-2C-GN, MFP-225-4C, MFP-225-4C-GN, MFP-225-6C, MFP-225-6C-GN, MFP-225-8C, MFP-225-8C-GN, MFP-225-B, MFP-225-B2-GN, MFP-225-B-GN, MFP-237-10C...(Other models you can see in the webshop) |                 |                        |

rollers

rollers



|                    |  |                 |  |
|--------------------|--|-----------------|--|
| 1                  |  |                 |  |
| <b>GEV No.</b>     | 501343   | <b>Ref. No.</b> | 12034280<br>12038133<br>GQ500214<br>SPQ510708P |
| <b>description</b> | roller rollerø 75mm B1 12mm overall width 25mm A 75mm B 12mm C 25mm plastic tread rubber |                 |  |
| <b>For models:</b> | SE-7   |                 |  |

accessories



|                    |                  |                 |   |
|--------------------|------------------|-----------------|---|
| 1                  |                  |                 |   |
| <b>GEV No.</b>     | 505252           | <b>Ref. No.</b> | 12037139<br>12038096<br>SPQ56461<br>SPQ56461P |
| <b>description</b> | shaft for roller |                 |   |



fittings for catering equipment **Зип-Общепит**

outlet taps

producer-specific

FAGOR



1

|                    |  |                 |                     |
|--------------------|--|-----------------|---------------------|
| <b>GEV No.</b>     | 514325   | <b>Ref. No.</b> | 12009231<br>X036107 |
| <b>description</b> | ball valve connection 1" IT - 1" IT DN25 total length 83mm with lever handle |                 |                     |



1

|                    |  |                 |                     |
|--------------------|--|-----------------|---------------------|
| <b>GEV No.</b>     | 541595   | <b>Ref. No.</b> | 12019141<br>X166134 |
| <b>description</b> | drain pipe L 140mm thread 1" ET                              |                 |                     |
| <b>For models:</b> | FE9-05, FE9-05S, FE9-05USMC, FE9-10, FG9-05, FG9-05S, FG9-10 |                 |                     |

aerators and air bleeders



1

|                    |   |                 |                     |
|--------------------|---|-----------------|---------------------|
| <b>GEV No.</b>     | 540827  | <b>Ref. No.</b> | 12009434<br>S022103 |
| <b>description</b> | aerator and air bleeder thread 3/4" ET chrome-plated L 45mm ø 36mm  |                 |                     |
| <b>For models:</b> | ME7-10BM, ME9-10BM, ME9-10BMS, ME9-10PLUS-BM, ME9-10PLUS-BMS, ME9-15BM, ME9-15BM316, ME9-15BM-AD, ME9-15BMS, ME9-15PLUS-BM, ME9-15PLUS-BMS, MG9-10BM, MG9-10BMAD, MG9-10BMS, MG9-10BMSAD, MG9-10PLUS-BM, MG9-10PLUS-BMS, MG9-15BM, MG9-15BM316, MG9-15BMAD, MG9-15BMS, MG9-15BMSAD, MG9-15PLUS-BM, MG9-15PLUS-BMS, MPE9-10BM, MPE9-10BMS, MPE9-15BM, MPE9-15BMS, MPG9-10BM, MPG9-10BMS, MPG9-15BM, MPG9-15BMS, MV9-10BM, MV9-15BM |                 |                     |



1

|                    |   |                 |                      |
|--------------------|---|-----------------|----------------------|
| <b>GEV No.</b>     | 540825  | <b>Ref. No.</b> | 12038036<br>ICR14945 |
| <b>description</b> | aerator and air bleeder thread 3/8" ET WS 24 chrome-plated L 37mm |                 |                      |

Id fittings

type RUBINETTERIE DEL FRIULI

for circular lids

spare parts



1

|                    |  |                 |                      |
|--------------------|--|-----------------|----------------------|
| <b>GEV No.</b>     | 540855   | <b>Ref. No.</b> | 12032821<br>ICR08052 |
| <b>description</b> | torsion spring ø 50.8mm wire gauge ø 5.1mm L1 34mm L2 104mm L3 29mm mounting pos. left |                 |                      |

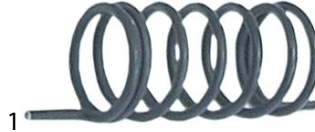

1

|                    |   |                 |                      |
|--------------------|---|-----------------|----------------------|
| <b>GEV No.</b>     | 540854  | <b>Ref. No.</b> | 12032818<br>ICR08051 |
| <b>description</b> | torsion spring ø 50.8mm wire gauge ø 5.1mm L1 34mm L2 104mm L3 29mm mounting pos. right |                 |                      |

FIREX

spare parts



1

|                    |  |                 |                      |
|--------------------|--|-----------------|----------------------|
| <b>GEV No.</b>     | 540855   | <b>Ref. No.</b> | 12032821<br>ICR08052 |
| <b>description</b> | torsion spring ø 50.8mm wire gauge ø 5.1mm L1 34mm L2 104mm L3 29mm mounting pos. left |                 |                      |



1

|                    |   |                 |                      |
|--------------------|---|-----------------|----------------------|
| <b>GEV No.</b>     | 540854  | <b>Ref. No.</b> | 12032818<br>ICR08051 |
| <b>description</b> | torsion spring ø 50.8mm wire gauge ø 5.1mm L1 34mm L2 104mm L3 29mm mounting pos. right |                 |                      |

ICOS



1

|                    |                                  |                 |                      |
|--------------------|----------------------------------|-----------------|----------------------|
| <b>GEV No.</b>     | 514129                           | <b>Ref. No.</b> | 12029452<br>ICR16158 |
| <b>description</b> | adjusting bush L 100mm ø 70/60mm |                 |                      |

Зип Общепит  
vsezip.ru  
+7(812)987-08-81



|                    |  |                 |                      |
|--------------------|--|-----------------|----------------------|
| <b>GEV No.</b>     | 540855   | <b>Ref. No.</b> | 12032821<br>ICR08052 |
| <b>description</b> | torsion spring $\phi$ 50.8mm wire gauge $\phi$ 5.1mm L1 34mm L2 104mm L3 29mm mounting pos. left |                 |                      |

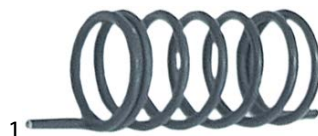

|                    |   |                 |                      |
|--------------------|---|-----------------|----------------------|
| <b>GEV No.</b>     | 540854  | <b>Ref. No.</b> | 12032818<br>ICR08051 |
| <b>description</b> | torsion spring $\phi$ 50.8mm wire gauge $\phi$ 5.1mm L1 34mm L2 104mm L3 29mm mounting pos. right |                 |                      |

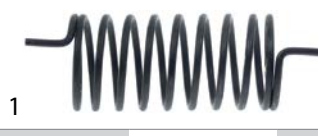

|                    |  |                 |                      |
|--------------------|--|-----------------|----------------------|
| <b>GEV No.</b>     | 514346   | <b>Ref. No.</b> | 12032819<br>ICR08008 |
| <b>description</b> | torsion spring $\phi$ 51.5mm wire gauge $\phi$ 4.1mm L1 21mm L2 110mm L3 21mm mounting pos. left |                 |                      |

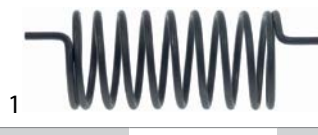

|                    |   |                 |          |
|--------------------|---|-----------------|----------|
| <b>GEV No.</b>     | 514339  | <b>Ref. No.</b> | ICR08007 |
| <b>description</b> | torsion spring $\phi$ 51.8mm wire gauge $\phi$ 4.1mm L1 20mm L2 106mm L3 20mm mounting pos. right |                 |          |



|                    |  |                 |   |
|--------------------|--|-----------------|---|
| <b>GEV No.</b>     | 514352   | <b>Ref. No.</b> | 12032815<br>12033015<br>ICR08093<br>ICRI08093 |
| <b>description</b> | torsion spring $\phi$ 51mm wire gauge $\phi$ 6.5mm L1 28mm L2 101mm L3 28mm mounting pos. left |                 |   |



|                    |   |                 |   |
|--------------------|---|-----------------|---|
| <b>GEV No.</b>     | 514351  | <b>Ref. No.</b> | 12032816<br>12033014<br>ICR08083<br>ICRI08083 |
| <b>description</b> | torsion spring $\phi$ 51mm wire gauge $\phi$ 6.5mm L1 28mm L2 101mm L3 28mm mounting pos. right |                 |   |



|                    |   |                 |                      |
|--------------------|---|-----------------|----------------------|
| <b>GEV No.</b>     | 514350  | <b>Ref. No.</b> | 12032817<br>ICR08055 |
| <b>description</b> | torsion spring $\phi$ 51mm wire gauge $\phi$ 6mm L1 28mm L2 95mm L3 28mm mounting pos. left |                 |                      |



|                    |  |                 |                      |
|--------------------|--|-----------------|----------------------|
| <b>GEV No.</b>     | 514349   | <b>Ref. No.</b> | 12032814<br>ICR08054 |
| <b>description</b> | torsion spring $\phi$ 51mm wire gauge $\phi$ 6mm L1 28mm L2 95mm L3 28mm mounting pos. right |                 |                      |

miscellaneous

spare parts



|                    |  |                 |                     |
|--------------------|--|-----------------|---------------------|
| <b>GEV No.</b>     | 514165   | <b>Ref. No.</b> | 12009142<br>S116120 |
| <b>description</b> | adjusting bush for lid hinge   |                 |                     |
| <b>For models:</b> | ME9-10BM, ME9-10BMS, ME9-15BM, ME9-15BM316, ME9-15BMS, MG9-10, MG-9100, MG9-10BM, MG9-10BMS, MG9-10S, MG9-15, MG-9150, MG-9150BM, MG9-15BM, MG9-15BMS, MG9-15S, MG9-20, MG-9200, MG9-20S, MPE9-10BM, MPE9-10BMS, MPE9-15BM, MPE9-15BMS, MPG9-10, MPG9-10BM, MPG9-10BMS, MPG9-10S, MPG9-15, MPG-9150, MPG9-15BM, MPG9-15BMS, MPG9-15S, MPG9-20, MPG-9200, MPG9-20S, MV9-10BM, MV9-15BM, SBE7-10, SBE9-10, SBE9-10I, SBE9-10IM, SBE9-10IMS, SBE9-10IS, SBE9-10M, SBE9-10MS, SBE9-10S, SBE9-10USMC, SBE9-15IM, SBE9-15IMS, SBE9-15M...(Other models you can see in the webshop) |                 |                     |

Зип Общепит

vsezip.ru

+7(812)987-08-81



1

|                    |   |                 |                     |
|--------------------|---|-----------------|---------------------|
| <b>GEV No.</b>     | 691727  | <b>Ref. No.</b> | 12009136<br>S116118 |
| <b>description</b> | bearing brass H 15mm ID ø 22mm ø 49mm   |                 |                     |
| <b>For models:</b> | ME9-10BM, ME9-10BMS, ME9-15BM, ME9-15BM316, ME9-15BMS, MG9-10, MG-9100, MG9-10BM, MG9-10BMS, MG9-10S, MG9-15, MG-9150, MG-9150BM, MG9-15BM, MG9-15BM316, MG9-15BMS, MG9-15S, MG9-20, MG-9200, MG9-20S, MPE9-10BM, MPE9-10BMS, MPE9-15BM, MPE9-15BMS, MPG9-10, MPG9-10BM, MPG9-10BMS, MPG9-10S, MPG9-15, MPG-9150, MPG9-15BM, MPG9-15BMS, MPG9-15S, MPG9-20, MPG-9200, MPG9-20S, MV9-10BM, MV9-15BM, SBE7-10, SBE9-10, SBE9-10I, SBE9-10IM, SBE9-10IMS, SBE9-10IS, SBE9-10M, SBE9-10MS, SBE9-10S, SBE9-10USMC, SBE9-15IM, SBE9-15IMS...(Other models you can see in the webshop) |                 |                     |



1

|                    |  |                 |                     |
|--------------------|--|-----------------|---------------------|
| <b>GEV No.</b>     | 514167   | <b>Ref. No.</b> | 12008056<br>S116126 |
| <b>description</b> | bush for lid hinge ID ø 15mm ED ø 20mm H 10mm  |                 |                     |
| <b>For models:</b> | ME9-10BM, ME9-10BMS, ME9-15BM, ME9-15BM316, ME9-15BMS, MG9-10, MG-9100, MG9-10BM, MG9-10BMS, MG9-10S, MG9-15, MG-9150, MG-9150BM, MG9-15BM, MG9-15BM316, MG9-15BMS, MG9-15S, MG9-20, MG-9200, MG9-20S, MPE9-10BM, MPE9-10BMS, MPE9-15BM, MPE9-15BMS, MPG9-10, MPG9-10BM, MPG9-10BMS, MPG9-10S, MPG9-15, MPG-9150, MPG9-15BM, MPG9-15BMS, MPG9-15S, MPG9-20, MPG-9200, MPG9-20S, MV9-10BM, MV9-15BM, SBE7-10, SBE9-10, SBE9-10I, SBE9-10I-AD, SBE9-10I-AD-S, SBE9-10IM, SBE9-10IMS, SBE9-10IS, SBE9-10M, SBE9-10MS, SBE9-10PLUS-I, SBE9-10PLUS-SI...(Other models you can see in the webshop) |                 |                     |



2

|                    |  |                 |                     |
|--------------------|--|-----------------|---------------------|
| <b>GEV No.</b>     | 514166   | <b>Ref. No.</b> | 12008144<br>S116119 |
| <b>description</b> | bearing for lid hinge  |                 |                     |
| <b>For models:</b> | ME9-10BM, ME9-10BMS, ME9-15BM, ME9-15BM316, ME9-15BMS, MG9-10, MG-9100, MG9-10BM, MG9-10BMS, MG9-10S, MG9-15, MG-9150, MG-9150BM, MG9-15BM, MG9-15BMS, MG9-15S, MG9-20, MG-9200, MG9-20S, MPE9-10BM, MPE9-10BMS, MPE9-15BM, MPE9-15BMS, MPG9-10, MPG9-10BM, MPG9-10BMS, MPG9-10S, MPG9-15, MPG-9150, MPG9-15BM, MPG9-15BMS, MPG9-15S, MPG9-20, MPG-9200, MPG9-20S, MV9-10BM, MV9-15BM, SBE7-10, SBE9-10, SBE9-10I, SBE9-10IM, SBE9-10IMS, SBE9-10IS, SBE9-10M, SBE9-10MS, SBE9-10S, SBE9-10USMC, SBE9-15IM, SBE9-15IMS, SBE9-15M...(Other models you can see in the webshop) |                 |                     |



1

|                    |   |                 |  |
|--------------------|---|-----------------|--|
| <b>GEV No.</b>     | 514162  | <b>Ref. No.</b> | 12009452<br>12040017<br>S036130<br>S036143 |
| <b>description</b> | lid hinge body  |                 |  |
| <b>For models:</b> | ME9-10BM, ME9-10BMS, ME9-15BM, ME9-15BM316, ME9-15BMS, MG9-10, MG9-10BM, MG9-10BMS, MG9-10S, MG9-15, MG9-15BM, MG9-15BMS, MG9-15S, MG9-20, MG9-20S, MPE9-10BM, MPE9-10BMS, MPE9-15BM, MPE9-15BMS, MPG9-10, MPG9-10BM, MPG9-10BMS, MPG9-10S, MPG9-15, MPG9-15BM, MPG9-15BMS, MPG9-15S, MPG9-20, MPG9-20S, MV9-10BM, MV9-15BM |                 |  |



1

|                    |  |                 |                                 |
|--------------------|--|-----------------|---------------------------------|
| <b>GEV No.</b>     | 514169   | <b>Ref. No.</b> | 12038909<br>12039166<br>X286102 |
| <b>description</b> | bracket for lid hinge  |                 |                                 |
| <b>For models:</b> | SBE7-10, SBE9-10, SBE9-10I, SBE9-10IM, SBE9-10IMS, SBE9-10IS, SBE9-10M, SBE9-10MS, SBE9-10S, SBE9-10USMC, SBE9-15IM, SBE9-15IMS, SBE9-15M, SBE9-15MS, SBG7-10, SBG9-10, SBG9-10I, SBG9-10IM, SBG9-10IMS, SBG9-10IS, SBG9-10M, SBG9-10MS, SBG9-10S, SBG9-15IM, SBG9-15IMS |                 |                                 |



1

|                    |  |                 |                     |
|--------------------|--|-----------------|---------------------|
| <b>GEV No.</b>     | 514164   | <b>Ref. No.</b> | 12009439<br>X156101 |
| <b>description</b> | lid hinge body   |                 |                     |
| <b>For models:</b> | SBE7-10, SBE9-10, SBE9-10I, SBE9-10IM, SBE9-10IMS, SBE9-10IS, SBE9-10M, SBE9-10MS, SBE9-10S, SBE9-10USMC, SBE9-15IM, SBE9-15IMS, SBE9-15M, SBE9-15MS, SBG7-10, SBG9-10, SBG9-10I, SBG9-10IM, SBG9-10IMS, SBG9-10IS, SBG9-10M, SBG9-10MS, SBG9-10S, SBG9-15IM, SBG9-15IMS |                 |                     |

Зип-Общепит

vsezip.ru

+7(812)987-08-81

|   |  |                 |                     |
|---|--|-----------------|---------------------|
|  |  |                 |                     |
| 1   |  |                 |                     |
| <b>GEV No.</b>  | 691016   | <b>Ref. No.</b> | 12009030<br>S116121 |
| <b>description</b>  | torsion spring $\phi$ 44mm L 124mm wire gauge $\phi$ 5.6mm   |                 |                     |
| <b>For models:</b>  | ME9-10BM, ME9-10BMS, ME9-15BM, ME9-15BM316, ME9-15BMS, MG9-10, MG-9100, MG9-10BM, MG9-10BMS, MG9-10S, MG9-15, MG-9150, MG-9150BM, MG9-15BM, MG9-15BMS, MG9-15S, MG9-20, MG-9200, MG9-20S, MPE9-10BM, MPE9-10BMS, MPE9-15BM, MPE9-15BMS, MPG9-10, MPG9-10BM, MPG9-10BMS, MPG9-10S, MPG9-15, MPG-9150, MPG9-15BM, MPG9-15BMS, MPG9-15S, MPG9-20, MPG-9200, MPG9-20S, MV9-10BM, MV9-15BM, SBE7-10, SBE9-10, SBE9-10I, SBE9-10IM, SBE9-10IMS, SBE9-10IS, SBE9-10M, SBE9-10MS, SBE9-10S, SBE9-10USMC, SBE9-15IM, SBE9-15IMS, SBE9-15M...(Other models you can see in the webshop) |                 |                     |

### lid catches

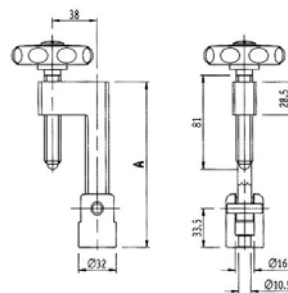
|   |                                     |                 |                      |
|---|-------------------------------------|-----------------|----------------------|
|  |                                     |                 |                      |
| 1   |                                     |                 |                      |
| <b>GEV No.</b>  | 514127                              | <b>Ref. No.</b> | 12038051<br>ICR10030 |
| <b>description</b>  | lid lock handle $\phi$ 70mm L 143mm |                 |                      |
|  |                                     |                 |                      |

### drain taps

#### brass

#### drain taps

|   |  |                 |                     |
|---|--|-----------------|---------------------|
|  |  |                 |                     |
| 1   |  |                 |                     |
| <b>GEV No.</b>  | 540132   | <b>Ref. No.</b> | 12016791<br>S312100 |
| <b>description</b>  | drain tap 1 1/2" IT conical seal kettle A 90mm B 137mm B1 70mm chrome-plated brass |                 |                     |
| <b>For models:</b>  | ME7-10BM, MG7-10, MG7-10BM   |                 |                     |
| <b>spare parts for</b>  | 540132   |                 |                     |
|  | <b>GEV No.</b>   | 540213          | <b>Ref. No.</b> —   |
|   | handle ID $\phi$ 5mm L 117mm   |                 |                     |
|  | <b>GEV No.</b>   | 540461          | <b>Ref. No.</b> —   |
|   | shim for drain tap   |                 |                     |
|  | <b>GEV No.</b>   | 540464          | <b>Ref. No.</b> —   |
|   | nut for drain tap thread 1 1/2"  |                 |                     |

|                        |   |                 |   |
|------------------------|---|-----------------|---|
| accessories for 540132 |   |                 |   |
| <b>GEV No.</b>         | 510404  | <b>Ref. No.</b> | — |
|                        | flat gasket fibre ED $\phi$ 44mm ID $\phi$ 34mm thickness 2mm Qty 1 pcs |                 |   |

|  |   |                 |  |
|--|---|-----------------|--|
|  |   |                 |  |
| 1  |   |                 |  |
| <b>GEV No.</b>   | 541673  | <b>Ref. No.</b> | 12008890<br>12016692<br>S312112<br>S532106 |
| <b>description</b>   | drain tap 1 1/2" IT with union nut conical seal |                 |  |
| <b>For models:</b>   | ME7-10BM, MG7-10, MG7-10BM, MV7-10BM            |                 |  |
| <b>spare parts for</b>   | 541673  |                 |  |

|   |   |        |                   |
|---|---|--------|-------------------|
|    | <b>GEV No.</b>  | 540213 | <b>Ref. No.</b> — |
|   | handle ID $\phi$ 5mm L 117mm  |        |                   |
|    | <b>GEV No.</b>  | 540956 | <b>Ref. No.</b> — |
|   | gasket for drain tap hose ext. $\phi$ 46mm ID $\phi$ 38mm H 2mm                                   |        |                   |
| <b>accessories for</b> 541673   |   |        |                   |
|  | <b>GEV No.</b>  | 510404 | <b>Ref. No.</b> — |
|   | flat gasket fibre ED $\phi$ 44mm ID $\phi$ 34mm thickness 2mm Qty 1 pcs                           |        |                   |
|  | <b>GEV No.</b>  | 890116 | <b>Ref. No.</b> — |
|   | fitting grease FERMIT GLISSA tube 60g -20 up to +140°C approval complies with KTW recommendation  |        |                   |
|  | <b>GEV No.</b>  | 890118 | <b>Ref. No.</b> — |
|   | fitting grease FERMIT GLISSA can 1000g -20 up to +140°C approval complies with KTW recommendation |        |                   |
|  | <b>GEV No.</b>  | 890119 | <b>Ref. No.</b> — |
|   | fitting grease FERMIT GLISSA tube 30g -20 up to +140°C approval complies with KTW recommendation  |        |                   |

|  |   |                 |                      |
|--|---|-----------------|----------------------|
|  |   |                 |                      |
| 1  |   |                 |                      |
| <b>GEV No.</b>   | 540275  | <b>Ref. No.</b> | 12026376<br>ICR10027 |
| <b>description</b>   | drain tap 2" IT with union nut A 90mm B 151mm B1 80mm chrome-plated brass |                 |                      |
| <b>spare parts for</b>   | 540275  |                 |                      |
|   | <b>GEV No.</b>  | 540214          | <b>Ref. No.</b> —    |
|  | handle ID $\phi$ 6mm L 145mm  |                 |                      |

Table continues overleaf





Зип Общежит







safety fittings

vsezip.ru

+7(812)987-08-81

|   |         |        |            |
|---|---------|--------|------------|
| <b>accessories for</b> 540275   |         |        |            |
|  | GEV No. | 529484 | Ref. No. — |
| flat gasket fibre ED $\phi$ 58mm ID $\phi$ 50mm thickness 2mm Qty 1 pcs           |         |        |            |
|  | GEV No. | 542448 | Ref. No. — |
| gasket silicone 60x49x2 for drain tap 2"  |         |        |            |

|   |  |                 |  |
|---|--|-----------------|--|
|    |  |                 |  |
| 1   |  |                 |  |
| <b>GEV No.</b>  | 540267   | <b>Ref. No.</b> | 12016604<br>12016772<br>S042107<br>S112150 |
| <b>description</b>  | drain tap connection with union nut thread 2"  |                 |  |
| <b>For models:</b>  | ME9-10BM, ME9-10BMS, ME9-15BM, ME9-15BM316, ME9-15BMS, MG9-10, MG9-10BM, MG9-10BMS, MG9-10S, MG9-15, MG9-15BM, MG9-15BM316, MG9-15BMS, MG9-15S, MG9-20, MG9-20S, MPE9-10BM, MPE9-10BMS, MPE9-15BM, MPE9-15BMS, MPG9-10, MPG9-10BM, MPG9-10BMS, MPG9-10S, MPG9-15, MPG9-15BM, MPG9-15BMS, MPG9-15S, MPG9-20, MPG9-20S |                 |  |
| <b>spare parts for</b>  | 540267   |                 |  |
|  | GEV No.  | 505517          | Ref. No. —                                 |
| O-ring EPDM thickness 5.34mm ID $\phi$ 53.34mm Qty 1 pcs                            |  |                 |  |
|  | GEV No.  | 540214          | Ref. No. —                                 |
| handle ID $\phi$ 6mm L 145mm  |  |                 |  |



|  |  |                 |  |
|--|--|-----------------|--|
|     |  |                 |  |
| 1  |  |                 |  |
| <b>GEV No.</b>   | 514276   | <b>Ref. No.</b> | 12038064<br>ICR11032                                 |
| <b>description</b>   | safety fitting thread 3/4" 0.45bar H 165mm $\phi$ 65mm |                 |  |
| <b>spare parts for</b>   | 514276   |                 |  |
|     | GEV No.  | 514094          | Ref. No. —   |
| angle piece thread 3/8"  |  |                 |  |
|     | GEV No.  | 514276          | Ref. No. 12038064<br>ICR11032                        |
| safety fitting thread 3/4" 0.45bar H 165mm $\phi$ 65mm                               |  |                 |  |
|     | GEV No.  | 540825          | Ref. No. 12038036<br>ICR14945                        |
| aerator and air bleeder thread 3/8" ET WS 24 chrome-plated L 37mm                    |  |                 |  |
|   | GEV No.  | 540828          | Ref. No. 12009418<br>12030738<br>ICR10023<br>S022102 |
| manometer siphon thread 3/8"   |  |                 |  |
|   | GEV No.  | 541579          | Ref. No. 12038013<br>ICR10022                        |
| manometer $\phi$ 52mm pressure range 0 up to 1bar connection marking 0.5 thread 1/4" |  |                 |  |

test taps

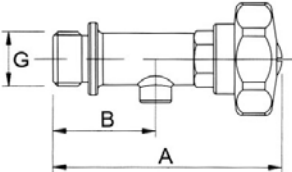
test taps

|   |  |                 |   |
|---|--|-----------------|---|
|  |  |                 |   |
| 1   |  |                 |   |
|  |  |                 |   |
| <b>GEV No.</b>  | 540818   | <b>Ref. No.</b> | 12009417<br>12030706<br>12038031<br>FX30200050<br>ICR10044<br>S102124 |
| <b>description</b>  | test tap thread 1/2" ET W 88mm W1 38mm   |                 |   |
| <b>For models:</b>  | ME7-10BM, ME9-10BM, ME9-10BMS, ME9-15BM, ME9-15BM316, ME9-15BMS, MG7-10BM, MG9-10BM, MG9-10BMS, MG9-15BM, MG9-15BM316, MG9-15BMS, MPE9-10BM, MPE9-10BMS, MPE9-15BM, MPE9-15BMS, MPG9-10BM, MPG9-10BMS, MPG9-15BM, MPG9-15BMS |                 |   |

accessories

|   |   |                 |                              |
|---|---|-----------------|------------------------------|
|  |   |                 |                              |
| 1   |   |                 |                              |
| <b>GEV No.</b>  | 540817  | <b>Ref. No.</b> | 12028301<br>ICR10014         |
| <b>description</b>  | fitting support thread 1/2" ET suitable for manometer |                 |                              |
|  |   |                 |                              |
| 1   |   |                 |                              |
| <b>GEV No.</b>  | 540832  | <b>Ref. No.</b> | 12009386<br>S332100          |
| <b>description</b>  | fitting support thread 1/2" ET suitable for manometer |                 |                              |
| <b>For models:</b>  | ME7-10BM  |                 |                              |
| <b>accessories for</b>  | 540832  |                 |                              |
|  | GEV No.   | 510166          | Ref. No. 12019584<br>Q306049 |
| flat gasket fibre ED $\phi$ 31.3mm ID $\phi$ 26.3mm thickness 1.2mm Qty 1 pcs       |   |                 |                              |

Зип Общежит

safety valves

vsezip.ru

7(812)987-08-81

|   |   |                 |                     |
|---|---|-----------------|---------------------|
|  |   |                 |                     |
| 1   |   |                 |                     |
| <b>GEV No.</b>  | 540822  | <b>Ref. No.</b> | 12009448<br>S022100 |
| <b>description</b>  | fitting support thread 3/4"   |                 |                     |
| <b>For models:</b>  | ME9-10BM, ME9-10BMS, ME9-10PLUS-BM, ME9-10PLUS-BMS, ME9-15BM, ME9-15BM316, ME9-15BM-AD, ME9-15BMS, ME9-15PLUS-BM, ME9-15PLUS-BMS, MG9-10BM, MG9-10BMAD, MG9-10BMS, MG9-10BMSAD, MG9-10PLUS-BM, MG9-10PLUS-BMS, MG9-15BM, MG9-15BM316, MG9-15BMAD, MG9-15BMS, MG9-15BMSAD, MG9-15PLUS-BM, MG9-15PLUS-BMS, MPE9-10BM, MPE9-10BMS, MPE9-15BM, MPE9-15BMS, MPG9-10BM, MPG9-10BMS, MPG9-15BM, MPG9-15BMS, MV9-10BM, MV9-15BM |                 |                     |



|  |                                  |                 |                      |
|--|----------------------------------|-----------------|----------------------|
|  |                                  |                 |                      |
| 1  |                                  |                 |                      |
| <b>GEV No.</b>   | 540722                           | <b>Ref. No.</b> | 12040552<br>ICR10004 |
| <b>description</b>   | safety valve with outlet for lid |                 |                      |

equipment feet and end caps

equipment feet

with screw mounting

universal

|   |   |                 |                   |
|---|---|-----------------|-------------------|
|    |   |                 |                   |
| 1   |   |                 |                   |
| <b>GEV No.</b>  | 540835  | <b>Ref. No.</b> | ICR10013          |
| <b>description</b>  | screw cap thread 3/4"                               |                 |                   |
| <b>spare parts for</b>  | 540835  |                 |                   |
|    | <b>GEV No.</b>                                      | 513016          | <b>Ref. No.</b> — |
|   | O-ring EPDM thickness 3.53mm ID ø 26.58mm Qty 1 pcs |                 |                   |
| <b>accessories for</b>  | 540835  |                 |                   |
|  | <b>GEV No.</b>                                      | 513016          | <b>Ref. No.</b> — |
|   | O-ring EPDM thickness 3.53mm ID ø 26.58mm Qty 1 pcs |                 |                   |

|  |  |                 |                        |
|--|--|-----------------|------------------------|
|  |  |                 |                        |
| 1  |  |                 |                        |
| <b>GEV No.</b>   | 700810   | <b>Ref. No.</b> | 12036002<br>6007050015 |
| <b>description</b>   | equipment foot tube ø 50mm thread M10 thread L 14mm H 110-140mm SS size 2" Qty 1 pcs   |                 |                        |
| <b>For models:</b>   | BFP-150, BFP-200, BFP-250, BFP-300, FMP-117-R, FMP-150, FMP-169-R, FMP-202, FMP-222-R, FMP-255, FMP-274-R, FMP-307, MCN-102-R, MCN-135, MCN-147-R, MCN-180, MCN-192-R, MCN-225, MCN-237-R, MCN-270, MCP-135, MCP-180, MCP-225, MEP-100, MEP-100G, MEP-135, MEP-180, MFN-102-R, MFN-135, MFN-147-R, MFN-180, MFN-192-R, MFN-225, MFN-237-R, MFN-270, MFP-102-2C, MFP-102-4C, MFP-135, MFP-135-2C, MFP-135-4C, MFP-135-F, MFP-147-2C, MFP-147-4C, MFP-147-6C, MFP-180, MFP-180-2C, MFP-180-4C, MFP-180-6C, MFP-180-F, MFP-192-2C...(Other models you can see in the webshop) |                 |                        |

|   |   |                 |   |
|---|---|-----------------|---|
|  |   |                 |   |
| 1   |   |                 |   |
| <b>GEV No.</b>  | 540828  | <b>Ref. No.</b> | 12009418<br>12030738<br>ICR10023<br>S022102 |
| <b>description</b>  | manometer siphon thread 3/8"  |                 |   |
| <b>For models:</b>  | ME9-10BM, ME9-10BMS, ME9-10PLUS-BM, ME9-10PLUS-BMS, ME9-15BM, ME9-15BM316, ME9-15BM-AD, ME9-15BMS, ME9-15PLUS-BM, ME9-15PLUS-BMS, MG9-10BM, MG9-10BMAD, MG9-10BMS, MG9-10BMSAD, MG9-10PLUS-BM, MG9-10PLUS-BMS, MG9-15BM, MG9-15BM316, MG9-15BMAD, MG9-15BMS, MG9-15BMSAD, MG9-15PLUS-BM, MG9-15PLUS-BMS, MPE9-10BM, MPE9-10BMS, MPE9-15BM, MPE9-15BMS, MPG9-10BM, MPG9-10BMS, MPG9-15BM, MPG9-15BMS, MV9-10BM, MV9-15BM |                 |   |





## Зип-Общепит

screw-in feet

vsezip.ru

+7(812)987-08-81

with fixing plate



|                    |  |                 |   |
|--------------------|--|-----------------|---|
| <b>GEV No.</b>     | 701100   | <b>Ref. No.</b> | 12009104<br>12033566<br>6007050017<br>X260151 |
| <b>description</b> | equipment foot tube ø 64mm plate size 82x82mm hole distance 65x65mm H 135-200mm SS size 2 1/2" Qty 1 pcs   |                 |   |
| <b>For models:</b> | AC-120, AC-180, ACE-061, ACE-101, ACE-102, ACG-061, ACG-101, ACG-102, AD-120, AD-120B, AD-120BBTDD-UK, AD-120C, AD-120CW, AD-120HY, AD-125, AD-125HRS, AD-125-SOFT, AD-72, AD-72W, AD-90, AD-90BA, AD-90BBT, AD-90BDD, AD-90DD, ADAEP-1602, ADAEP-801, ADAFN-1602, ADAFN-801, ADAFP-1602, ADAFP-801, ADE-120, ADE-120B, ADMCN-135, ADMCN-180, ADMCN-225, ADMCP-135, ADMCP-180, ADMCP-225, ADMFN-135, ADMFN-180, ADMFN-225, ADMFP-135, ADMFP-135-GR, ADMFP-135HD, ADMFP-135HH, ADMFP-135PC, ADMFP-180, ADMFP-180-GR, ADMFP-180HDD, ADMFP-180HHD...(Other models you can see in the webshop) |                 |   |



|                    |  |                 |                                   |
|--------------------|--|-----------------|-----------------------------------|
| <b>GEV No.</b>     | 510115   | <b>Ref. No.</b> | 12024163<br>6003010275<br>Z200107 |
| <b>description</b> | equipment foot thread M10 thread L 40mm ø 30mm H 10mm Qty 1 pcs  |                 |                                   |
| <b>For models:</b> | AD-15, AD-15D, AD-20C-UK, AD-21, AD-21B, AD-21BDD, AD-21C, AD-21D, AD-21DD, AD-21W, AD-45BBT, AD-48, AD-48B, AD-48BDD, AD-48C, AD-48D, AD-48DD, AD-48HY, AD-48W, AD-505, AD-505-SOFT, AD-64, AD-64B, AD-64BBT, AD-64BDD, AD-64BTDD, AD-64C, AD-64CW, AD-64D, AD-64DD, AD-64HY, BG6-05I, BG7-05, BG7-05I, BG7-10, BG7-10I, BG9-05, BG9-05AD, BG9-05I, BG9-05PF, BG9-05PI, BG9-05PLUS-I, BG9-10, BG9-10AD, BG9-10I, BG9-10PF, BG9-10PI, BG9-10PLUS-I, BME6-05, BME7-05...(Other models you can see in the webshop) |                 |                                   |

### bullet feet

plastic/SS



|                    |  |                 |                     |
|--------------------|--|-----------------|---------------------|
| <b>GEV No.</b>     | 700110   | <b>Ref. No.</b> | 12024301<br>R675610 |
| <b>description</b> | equipment foot pipe type 40x40 thickness 1-1.2mm H 23-60mm plastic/SS Qty 1 pcs  |                 |                     |
| <b>For models:</b> | ECO-120, ECO-120B, ECO-160, ECO-1600, ECO-160D, ECO-160I, ECO-200, ECO-200D, ECO-200H, ECO-200HD, ECO-200HI, ECO-200I, ECO-2300, ECO-280D, ECO-280I, ECO-3000, ECO-370D, ECO-370I, ECO-460D, ECO-460I, ECO-550D, ECO-550I, FI-100, FI-100AR, FI-100B, FI-120, FI-120B, FI-120W, FI-160, FI-1600, FI-160D, FI-160I, FI-200, FI-200D, FI-200H, FI-200HD, FI-200HI, FI-200I, FI-200W, FI-2300, FI-280D, FI-280I, FI-3000, FI-370D, FI-370I, FI-460D, FI-460I, FI-550D, FI-550I, FI-80...(Other models you can see in the webshop) |                 |                     |

### end caps and plugs

for circular pipes



|                    |   |                 |                        |
|--------------------|---|-----------------|------------------------|
| <b>GEV No.</b>     | 698846  | <b>Ref. No.</b> | 12037989<br>6003010262 |
| <b>description</b> | plug ø 20.5mm H 23.5mm Qty 1 pcs  |                 |                        |
| <b>For models:</b> | ADMFCN-135, ADMFCN-180, ADMFCN-225, ADMCP-135, ADMCP-180, ADMCP-225, ADMFN-135, ADMFN-180, ADMFN-225, ADMFP-135, ADMFP-135-GR, ADMFP-135HD, ADMFP-135HH, ADMFP-135PC, ADMFP-180, ADMFP-180-GR, ADMFP-180HDD, ADMFP-180HHD, ADMFP-180HHH, ADMFP-180PC, ADMFP-225, ADMFP-225-GR, ADMFP-225HDD, ADMFP-225HDD, ADMFP-225HH, ADMFP-225HHH, ADMFP-225PC, ATM-051, ATM-051VCH, ATM-051VCH-60Hz, ATM-081VCH, ATM-081VCH-60Hz, ATM-101, ATM-102, BFP-100, BFP-100A, BFP-100I, BFP-150, BFP-150A, BFP-150I, BFP-200, BFP-200A, BFP-200I, BFP-250, BFP-250A, BFP-250I, BFP-300, BFP-300I, CFMP-117-R, CFMP-117-RPC...(Other models you can see in the webshop) |                 |                        |

zamak/SS



|                    |   |                 |                        |
|--------------------|---|-----------------|------------------------|
| <b>GEV No.</b>     | 700112  | <b>Ref. No.</b> | 12029781<br>RT20390111 |
| <b>description</b> | equipment foot pipe type 40x40 thickness 1mm H 33-60mm Zamak/SS Qty 1 pcs |                 |                        |

### DERBY RUOTE

with bolt hole

stainless steel



|                    |   |                 |                        |
|--------------------|---|-----------------|------------------------|
| <b>GEV No.</b>     | 700222  | <b>Ref. No.</b> | 12031557<br>RT20050500 |
| <b>description</b> | swivel castor ø 125mm bolt hole bolt hole ø 12mm housing SS capacity 100kg bearing ball bearing wheel body polypropylene tread TPE tyres H 159mm wheel width 30mm Qty 1 pcs |                 |                        |



1

|                    |   |                 |                        |
|--------------------|---|-----------------|------------------------|
| <b>GEV No.</b>     | 700223 <sup>1</sup>   | <b>Ref. No.</b> | 12030115<br>RT20050602 |
| <b>description</b> | swivel castor with swivel brake ø 125mm bolt hole bolt hole ø 12mm housing SS capacity 100kg bearing ball bearing wheel body polypropylene tread TPE tyres H 159mm wheel width 30mm Qty 1 pcs |                 |                        |

<sup>1</sup>with swivel brake

## BLICKLE

plastic

ø125mm



1

|                    |   |                 |                       |
|--------------------|---|-----------------|-----------------------|
| <b>GEV No.</b>     | 701029  | <b>Ref. No.</b> | 12028289<br>RT6060100 |
| <b>description</b> | swivel castor with brake ø 125mm threaded shaft M10 housing plastic H 128mm |                 |                       |



1

|                    |  |                 |                       |
|--------------------|--|-----------------|-----------------------|
| <b>GEV No.</b>     | 700988   | <b>Ref. No.</b> | 12028422<br>RT6060101 |
| <b>description</b> | swivel castor without brake ø 125mm threaded shaft M10 housing plastic H 127mm |                 |                       |

## bumper angles



1

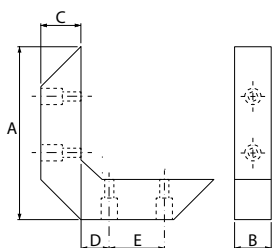

|                    |  |                 |                        |
|--------------------|--|-----------------|------------------------|
| <b>GEV No.</b>     | 691926   | <b>Ref. No.</b> | 12044928<br>6003010002 |
| <b>description</b> | bumper angle outer length 152mm inner length 118mm W 35mm H 28mm mounting distance 40mm hole distance 40mm hole ø 7mm plastic grey |                 |                        |

Зип.Общепит

Baskets

fryer baskets

vsezip.ru

FAGOR

+7(812)987-08-81



1

|                    |   |                 |                     |
|--------------------|---|-----------------|---------------------|
| <b>GEV No.</b>     | 691023                                  | <b>Ref. No.</b> | 12017424<br>X316503 |
| <b>description</b> | fryer basket L1 250mm W1 280mm H1 120mm |                 |                     |
| <b>For models:</b> | FE-710, FE-720, FG-710, FG-720          |                 |                     |



1

|                    |   |                 |                     |
|--------------------|---|-----------------|---------------------|
| <b>GEV No.</b>     | 970111  | <b>Ref. No.</b> | 12008702<br>X316531 |
| <b>description</b> | fryer basket L1 250mm W1 280mm H1 120mm stainless steel |                 |                     |
| <b>For models:</b> | FE7-05-1C, FE7-10-2C, FG7-05-1C, FG7-10-2C              |                 |                     |



1

|                    |  |                 |  |
|--------------------|--|-----------------|--|
| <b>GEV No.</b>     | 970631   | <b>Ref. No.</b> | 12009361<br>12017681<br>X316530<br>X316532 |
| <b>description</b> | fryer basket L1 255mm W1 135mm H1 120mm L2 230mm H2 185mm H3 225mm chrome-plated steel |                 |  |
| <b>For models:</b> | FE7-05-2C, FE-710, FE7-10-4C, FE-720, FG7-05-2C, FG-710, FG7-104C, FG7-10-4C, FG-720   |                 |  |



1

|                    |   |                 |                     |
|--------------------|---|-----------------|---------------------|
| <b>GEV No.</b>     | 970251                                  | <b>Ref. No.</b> | 12009390<br>X376503 |
| <b>description</b> | fryer basket L1 255mm W1 285mm H1 100mm |                 |                     |
| <b>For models:</b> | FE-8                                    |                 |                     |

Зип Общепит

vsezip.ru

+7(812)987-08-81



1

|   |   |                 |                            |
|---|---|-----------------|----------------------------|
| <b>GEV No.</b>  | 970359  | <b>Ref. No.</b> | FAG6000002                 |
| <b>description</b>  | fryer basket L1 310mm W1 130mm H1 120mm chrome-plated steel |                 |                            |
| <b>accessories for</b>  | 970359  |                 |                            |
|  | <b>GEV No.</b>  | 970632          | <b>Ref. No.</b> FAG6000013 |
|   | crumb screen L 338mm W 134mm H 100mm                        |                 |                            |

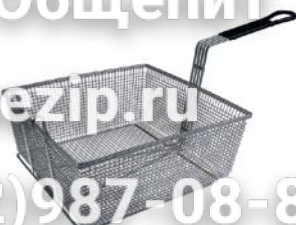

1

|                    |  |                 |                     |
|--------------------|--|-----------------|---------------------|
| <b>GEV No.</b>     | 970652   | <b>Ref. No.</b> | 12017089<br>X066595 |
| <b>description</b> | fryer basket L1 315mm W1 335mm H1 135mm                                  |                 |                     |
| <b>For models:</b> | FE9-05, FE9-05S, FE9-10, FE-920, FG9-05, FG9-05S, FG9-10, FG-920, FG-940 |                 |                     |



1

|                    |   |                 |                     |
|--------------------|---|-----------------|---------------------|
| <b>GEV No.</b>     | 970486  | <b>Ref. No.</b> | 12009368<br>X166525 |
| <b>description</b> | fryer basket L1 310mm W1 160mm H1 130mm L2 550mm H2 180mm stainless steel   |                 |                     |
| <b>For models:</b> | FE9-05, FE9-05-2C, FE9-05AD, FE9-05PLUS, FE9-05PLUS-S, FE9-05S, FE9-05S-2C, FE9-05S-AD, FE9-05USMC, FE9-10, FE9-10-4C, FE9-10AD, FE9-10PLUS, FG9-05, FG9-05-2C, FG9-05AD, FG9-05PLUS, FG9-05PLUS-S, FG9-05S, FG9-05S-2C, FG9-05S-AD, FE9-10, FE9-10-4C, FE9-10AD, FE9-10PLUS, FGCL9-05, FGCL9-05-2C, FGCL9-05S-2C |                 |                     |



1

|                    |  |                 |         |
|--------------------|--|-----------------|---------|
| <b>GEV No.</b>     | 691009   | <b>Ref. No.</b> | X066596 |
| <b>description</b> | fryer basket L1 330mm W1 315mm H1 135mm chrome-plated iron |                 |         |



1

|                    |   |                 |                     |
|--------------------|---|-----------------|---------------------|
| <b>GEV No.</b>     | 970487  | <b>Ref. No.</b> | 12009408<br>X166526 |
| <b>description</b> | fryer basket L1 310mm W1 330mm H1 130mm stainless steel   |                 |                     |
| <b>For models:</b> | FE9-05, FE9-05-1C, FE9-05-2C, FE9-05S, FE9-05S-1C, FE9-10, FE9-10-2C, FE9-10-4C, FG9-05, FG9-05-1C, FG9-05S, FG9-05S-1C, FG9-10, FG9-10-2C, FGCL9-05-1C, FGCL9-05S-1C |                 |                     |



1

|                    |   |                 |                     |
|--------------------|---|-----------------|---------------------|
| <b>GEV No.</b>     | 505130  | <b>Ref. No.</b> | 12017414<br>X356502 |
| <b>description</b> | fryer basket W1 130mm L1 250mm H1 105mm stainless steel |                 |                     |
| <b>For models:</b> | FE-4, FE-8  |                 |                     |



1

|                    |   |                 |         |
|--------------------|---|-----------------|---------|
| <b>GEV No.</b>     | 691020                                  | <b>Ref. No.</b> | X066590 |
| <b>description</b> | fryer basket L1 315mm W1 160mm H1 130mm |                 |         |



1

|                    |  |                 |                     |
|--------------------|--|-----------------|---------------------|
| <b>GEV No.</b>     | 505297   | <b>Ref. No.</b> | 12009365<br>X356506 |
| <b>description</b> | fryer basket W1 130mm L1 255mm H1 105mm L2 460mm H2 180mm H3 190mm |                 |                     |
| <b>For models:</b> | FE-4, FE-8   |                 |                     |

Зип Общепит

vsezip.ru





+7(812)987-08-81

|   |   |                 |  |
|---|---|-----------------|--|
| 1  |   |                 |  |
| <b>GEV No.</b>  | 505131                                  | <b>Ref. No.</b> | 12009483<br>12017105<br>X399901<br>X399902 |
| <b>description</b>  | fryer basket W1 150mm L1 325mm H1 120mm |                 |  |
| <b>For models:</b>  | FE-25                                   |                 |  |

|   |   |                 |                                 |
|---|---|-----------------|---------------------------------|
| 1  |   |                 |                                 |
| <b>GEV No.</b>  | 691065  | <b>Ref. No.</b> | 12009392<br>12017245<br>X366502 |
| <b>description</b>  | fryer basket W1 220mm L1 250mm H1 100mm stainless steel |                 |                                 |
| <b>For models:</b>  | FE-6  |                 |                                 |

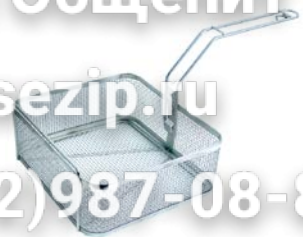
|   |   |                 |                     |
|---|---|-----------------|---------------------|
| 1  |   |                 |                     |
| <b>GEV No.</b>  | 505129                                  | <b>Ref. No.</b> | 12017031<br>X386501 |
| <b>description</b>  | fryer basket W1 233mm L1 265mm H1 120mm |                 |                     |
| <b>For models:</b>  | FE-18                                   |                 |                     |

|   |  |                 |          |
|---|--|-----------------|----------|
| 1  |  |                 |          |
| <b>GEV No.</b>  | 505270   | <b>Ref. No.</b> | 12009460 |
| <b>description</b>  | fryer basket W1 235mm L1 265mm H1 130mm H3 255mm |                 |          |
| <b>For models:</b>  | FE-18  |                 |          |

|  |  |                 |                                     |
|--|--|-----------------|-------------------------------------|
| 1  |  |                 |                                     |
| <b>GEV No.</b>   | 691066   | <b>Ref. No.</b> | 12017178<br>X376502                 |
| <b>description</b>   | fryer basket W1 280mm L1 250mm H1 100mm  |                 |                                     |
| <b>For models:</b>   | FE-8   |                 |                                     |
| <b>accessories for</b>   | 691066   |                 |                                     |
|     | <b>GEV No.</b>   | 560141          | <b>Ref. No.</b> —                   |
|  | hexagonal nut thread M5 H 5.4mm SS WS 8 Qty 20 pcs DIN/ISO DIN 985 self-locking                                |                 |                                     |
|     | <b>GEV No.</b>   | 560271          | <b>Ref. No.</b> —                   |
|  | raised countersunk head screw thread M5 thread L 14mm SS DIN 966/ISO 7047 Qty 20 pcs intake Phillips sunk head |                 |                                     |
|     | <b>GEV No.</b>   | 691001          | <b>Ref. No.</b> 12021230<br>9616402 |
|  | handle for fryer basket upper  |                 |                                     |
|     | <b>GEV No.</b>   | 691002          | <b>Ref. No.</b> 12021134<br>9616401 |
|  | handle for fryer basket lower  |                 |                                     |

|   |   |                 |  |
|---|---|-----------------|--|
| 1  |   |                 |  |
| <b>GEV No.</b>  | 691006  | <b>Ref. No.</b> | 12009617<br>12017023<br>X396501<br>X396503 |
| <b>description</b>  | fryer basket W1 330mm L1 320mm H1 125mm stainless steel |                 |  |
| <b>For models:</b>  | FE-25   |                 |  |

|   |  |                 |                     |
|---|--|-----------------|---------------------|
| 1  |  |                 |                     |
| <b>GEV No.</b>  | 970649   | <b>Ref. No.</b> | 12009174<br>X166527 |
| <b>description</b>  | basket support for fryer basket  |                 |                     |
| <b>For models:</b>  | FE9-05, FE9-05-1C, FE9-05-2C, FE9-05AD, FE9-05PLUS, FE9-05PLUS-S, FE9-05S, FE9-05S-1C, FE9-05S-2C, FE9-05S-AD, FE9-10, FE9-10-2C, FE9-10-4C, FE9-10AD, FE9-10PLUS, FG9-05, FG9-05-1C, FG9-05-2C, FG9-05AD, FG9-05PLUS, FG9-05PLUS-S, FG9-05S, FG9-05S-1C, FG9-05S-2C, FG9-05S-AD, FG9-10, FG9-10-2C, FG9-10-4C, FG9-10AD, FG9-10PLUS |                 |                     |

|   |  |                 |                     |
|---|--|-----------------|---------------------|
| 1  |  |                 |                     |
| <b>GEV No.</b>  | 970634   | <b>Ref. No.</b> | 12009173<br>X316501 |
| <b>description</b>  | basket support for fryer basket L 300mm H 90mm |                 |                     |
| <b>For models:</b>  | FE-710, FE-720, FG-710, FG-720                 |                 |                     |

Зип Общепит

vsezip.ru

87(812)987-08-81

1 

|                    |  |                 |                     |
|--------------------|--|-----------------|---------------------|
| <b>GEV No.</b>     | 691002   | <b>Ref. No.</b> | 12021134<br>9616401 |
| <b>description</b> | handle for fryer basket lower  |                 |                     |
| <b>For models:</b> | FE-18, FE-25, FE-4, FE-6, FE-710, FE-720, FE-8, FE9-05, FE9-05S, FE9-10, FE-920, FG-1-40, FG-2-80, FG-710, FG-720, FG9-05, FG9-05S, FG9-10, FG-920, FG-940 |                 |                     |

1 

|                    |  |                 |                     |
|--------------------|--|-----------------|---------------------|
| <b>GEV No.</b>     | 691001   | <b>Ref. No.</b> | 12021230<br>9616402 |
| <b>description</b> | handle for fryer basket upper  |                 |                     |
| <b>For models:</b> | FE-18, FE-25, FE-4, FE-6, FE-710, FE-720, FE-8, FE9-05, FE9-05S, FE9-10, FE-920, FG-1-40, FG-2-80, FG-710, FG-720, FG9-05, FG9-05S, FG9-10, FG-920, FG-940 |                 |                     |

1 

|                    |   |                 |                     |
|--------------------|---|-----------------|---------------------|
| <b>GEV No.</b>     | 970647  | <b>Ref. No.</b> | 12007730<br>H526503 |
| <b>description</b> | pasta basket L1 170mm W1 115mm H1 265mm stainless steel right |                 |                     |

pasta baskets

FAGOR

1 

|                    |  |                 |                     |
|--------------------|--|-----------------|---------------------|
| <b>GEV No.</b>     | 970645   | <b>Ref. No.</b> | 12008637<br>H506500 |
| <b>description</b> | pasta basket L1 160mm W1 290mm H1 210mm stainless steel  |                 |                     |
| <b>For models:</b> | CPE9-05, CPE9-05AD, CPE9-05AD-S, CPE9-05NC, CPE9-05PLUS, CPE9-05PLUS-S, CPE9-05S, CPG9-05, CPG9-05AD, CPG9-05AD-S, CPG9-05NC, CPG9-05PLUS, CPG9-05PLUS-S, CPG9-05S, CPG9-05SNC |                 |                     |

1 

|                    |  |                 |                     |
|--------------------|--|-----------------|---------------------|
| <b>GEV No.</b>     | 970646   | <b>Ref. No.</b> | 12009268<br>H526501 |
| <b>description</b> | pasta basket L1 170mm W1 115mm H1 265mm stainless steel left |                 |                     |

1 

|                    |  |                 |                     |
|--------------------|--|-----------------|---------------------|
| <b>GEV No.</b>     | 970644   | <b>Ref. No.</b> | 12009502<br>H526500 |
| <b>description</b> | pasta basket L1 180mm W1 230mm H1 265mm stainless steel  |                 |                     |
| <b>For models:</b> | CPE7-05, CPE7-05NC, CPG7-05, CPG7-05NC, EPC-350, GPC-350 |                 |                     |

crumb screens

1 

|                    |  |                 |                     |
|--------------------|--|-----------------|---------------------|
| <b>GEV No.</b>     | 691007   | <b>Ref. No.</b> | 12009154<br>X316502 |
| <b>description</b> | crumb screen L 332mm W 277mm suitable for fryer                      |                 |                     |
| <b>For models:</b> | FG7-05-1C, FG7-05-2C, FG-710, FG7-10-2C, FG7-104C, FG7-10-4C, FG-720 |                 |                     |

1 

|                    |   |                 |                     |
|--------------------|---|-----------------|---------------------|
| <b>GEV No.</b>     | 505143  | <b>Ref. No.</b> | 12009165<br>X186522 |
| <b>description</b> | crumb screen L 365mm W 350mm suitable for fryer   |                 |                     |
| <b>For models:</b> | FE9-05, FE9-05-1C, FE9-05-2C, FE9-05S, FE9-05S-1C, FE9-05S-2C, FE9-05USMC, FE9-10, FE9-10-2C, FE9-10-4C |                 |                     |

Зип.Общепит

vsezip.ru

+7(812)987-08-81

plastic baskets square

mix baskets

|                    |  |                 |                     |
|--------------------|--|-----------------|---------------------|
| <b>GEV No.</b>     | 971136   | <b>Ref. No.</b> | 12024550<br>Z415320 |
| <b>description</b> | mix basket L 352mm W 352mm H 105mm   |                 |                     |
| <b>For models:</b> | AD-15, AD-15D, CO-350, CO-350-B, CO-350-B-DD, CO-350-COLD, CO-350-COLD-B, CO-350-COLD-B-DD, CO-350-COLD-DD, CO-350-DD, CO-352-COLD, CO-352-COLD-B, CO-352-COLD-B-DD, CO-352-COLD-DD, LVC-12, LVC-15, LVC-15D |                 |                     |

|                    |   |                 |                    |
|--------------------|---|-----------------|--------------------|
| <b>GEV No.</b>     | 976000  | <b>Ref. No.</b> | 12025069<br>Z44532 |
| <b>description</b> | mix basket L 395mm W 395mm H 145mm  |                 |                    |
| <b>For models:</b> | AD-20C-UK, AD-21, AD-21B, AD-21BDD, AD-21C, AD-21D, AD-21DD, AD-21W, CO-400, CO-400-B, CO-400-B-DD, CO-400-COLD, CO-400-COLD-B, CO-400-COLD-B-DD, CO-400-COLD-DD, CO-400-DD, CO-400-SOFT, CO-402-COLD, CO-402-COLD-B, CO-402-COLD-B-DD, CO-402-COLD-DD, CO-402W, LVC-21, LVC-21B, LVC-21C, LVC-21D, LVC-21W |                 |                    |

|                    |   |                 |                     |
|--------------------|---|-----------------|---------------------|
| <b>GEV No.</b>     | 691022  | <b>Ref. No.</b> | 12009175<br>X166522 |
| <b>description</b> | crumb screen L 392mm W 342mm suitable for fryer   |                 |                     |
| <b>For models:</b> | FE9-05AD, FE9-05PLUS, FE9-05PLUS-S, FE9-05S-AD, FE9-10AD, FE9-10PLUS, FG9-05, FG9-05-1C, FG9-05-2C, FG9-05AD, FG9-05PLUS, FG9-05PLUS-S, FG9-05S, FG9-05S-1C, FG9-05S-2C, FG9-05S-AD, FG9-10, FG9-10-2C, FG9-10-4C, FG9-10AD, FG9-10PLUS, FGCL9-05, FGCL9-05-1C, FGCL9-05-2C, FGCL9-05S-1C, FGCL9-05S-2C |                 |                     |

|                    |   |                 |                     |
|--------------------|---|-----------------|---------------------|
| <b>GEV No.</b>     | 691021  | <b>Ref. No.</b> | 12019119<br>X166503 |
| <b>description</b> | crumb screen L 395mm W 335mm suitable for fryer |                 |                     |
| <b>For models:</b> | FE-920, FG-920, FG-940                          |                 |                     |

|                    |                                      |                 |            |
|--------------------|--------------------------------------|-----------------|------------|
| <b>GEV No.</b>     | 970632                               | <b>Ref. No.</b> | FAG6000013 |
| <b>description</b> | crumb screen L 338mm W 134mm H 100mm |                 |            |

warewashing baskets

plastic baskets round

|                    |  |                 |                     |
|--------------------|--|-----------------|---------------------|
| <b>GEV No.</b>     | 970648                                     | <b>Ref. No.</b> | 12020206<br>Z605304 |
| <b>description</b> | mix basket ED ø 350mm H 120mm seat ø 280mm |                 |                     |
| <b>For models:</b> | LVR-10, LVR-14, LVR-14D                    |                 |                     |

accessories

cutlery inserts

|                    |   |                 |          |
|--------------------|---|-----------------|----------|
| <b>GEV No.</b>     | 976010  | <b>Ref. No.</b> | 12025242 |
| <b>description</b> | cutlery insert Lmm Wmm ø 95mm H 105mm plastic   |                 |          |
| <b>For models:</b> | AD-15, AD-15D, AD-20C-UK, AD-21, AD-21B, AD-21BDD, AD-21C, AD-21D, AD-21DD, AD-21W, CO-350, CO-350-B, CO-350-B-DD, CO-350-COLD, CO-350-COLD-B, CO-350-COLD-B-DD, CO-350-COLD-DD, CO-350-DD, CO-352-COLD, CO-352-COLD-B, CO-352-COLD-B-DD, CO-352-COLD-DD, CO-400, CO-400-B, CO-400-B-DD, CO-400-COLD, CO-400-COLD-B, CO-400-COLD-B-DD, CO-400-COLD-DD, CO-400-DD, CO-400-SOFT, CO-402-COLD, CO-402-COLD-B, CO-402-COLD-B-DD, CO-402-COLD-DD, CO-402W, LVC-12, LVC-15, LVC-15D, LVC-21, LVC-21B, LVC-21C, LVC-21D, LVC-21W |                 |          |

sliding corners

|                    |  |                 |                     |
|--------------------|--|-----------------|---------------------|
| <b>GEV No.</b>     | 970001   | <b>Ref. No.</b> | 12039794<br>Z855303 |
| <b>description</b> | sliding corner wire gauge ø 5mm L 120mm W 120mm H 12mm L-shape |                 |                     |
| <b>For models:</b> | FI-300B, LVC-12, LVC-15  |                 |                     |



3ип Общежит shelves and shelf rails

vsezip.ru

(812)987-08-81

basket holders



|                    |  |                 |   |
|--------------------|--|-----------------|---|
| <b>GEV No.</b>     | 691910   | <b>Ref. No.</b> | 12000014<br>12000235<br>12012770<br>12038455<br>12Z7103250<br>12Z7103770<br>Z710311 |
| <b>description</b> | basket support L 540mm W 630mm suitable for FI 80 - 120 stainless steel  |                 |   |
| <b>For models:</b> | ECO-120, ECO-120B, FI-100, FI-100AR, FI-100B, FI-100BBT-UK, FI-120, FI-120AR+DD, FI-120B, FI-120C, FI-120HY-CLINIC, FI-120W, FI-80, FI-80AR, FI-80BBT-UK, FI-80W, FI-E-100, MF-120 |                 |   |

plate inserts



|                    |   |                 |                     |
|--------------------|---|-----------------|---------------------|
| <b>GEV No.</b>     | 976005  | <b>Ref. No.</b> | 12024286<br>Z605302 |
| <b>description</b> | plate insert L 335mm W 195mm H 105mm plates 10 plastic-coated   |                 |                     |
| <b>For models:</b> | AD-15, AD-15D, CO-350, CO-350-B, CO-350-B-DD, CO-350-COLD, CO-350-COLD-B, CO-350-COLD-B-DD, CO-350-COLD-DD, CO-350-DD, CO-352-COLD, CO-352-COLD-B, CO-352-COLD-B-DD, CO-352-COLD-DD, LVC-12, LVC-15, LVC-15D, LVR-14, LVR-14D |                 |                     |



|                    |  |                 |                     |
|--------------------|--|-----------------|---------------------|
| <b>GEV No.</b>     | 976014   | <b>Ref. No.</b> | 12025030<br>Z625302 |
| <b>description</b> | plate insert L 370mm W 195mm H 105mm plates 11 plastic-coated  |                 |                     |
| <b>For models:</b> | AD-20C-UK, AD-21, AD-21B, AD-21BDD, AD-21C, AD-21D, AD-21DD, AD-21W, CO-400, CO-400-B, CO-400-B-DD, CO-400-COLD, CO-400-COLD-B, CO-400-COLD-B-DD, CO-400-COLD-DD, CO-400-DD, CO-400-SOFT, CO-402-COLD, CO-402-COLD-B, CO-402-COLD-B-DD, CO-402-COLD-DD, CO-402W, LVC-21, LVC-21B, LVC-21C, LVC-21D, LVC-21W, LVR-20, LVR-20B, LVR-20D, MF-21 |                 |                     |

chargrill grids



|                    |                                       |                 |                     |
|--------------------|---------------------------------------|-----------------|---------------------|
| <b>GEV No.</b>     | 211047                                | <b>Ref. No.</b> | 12009424<br>T035464 |
| <b>description</b> | chargrill grid L 508mm W 339mm H 22mm |                 |                     |
| <b>For models:</b> | BG7-05, BG7-10                        |                 |                     |



|                    |  |                 |                                 |
|--------------------|--|-----------------|---------------------------------|
| <b>GEV No.</b>     | 211046   | <b>Ref. No.</b> | 12009442<br>12016227<br>T055413 |
| <b>description</b> | chargrill grid L 580mm W 410mm H 25mm chargrill      |                 |                                 |
| <b>For models:</b> | BG9-05, BG9-05I, BG9-05PF, BG9-10, BG9-10I, BG9-10PF |                 |                                 |

grates

universal

without upstand



|                    |   |                 |                        |
|--------------------|---|-----------------|------------------------|
| <b>GEV No.</b>     | 698836  | <b>Ref. No.</b> | 12035781<br>6027010003 |
| <b>description</b> | grate W 325mm D 530mm GN 1/1 H 10mm plastic-coated steel wire gauge frame 8mm lengthwise wires gauge 3mm crossing wires 2 grey  |                 |                        |
| <b>For models:</b> | ADMFCN-135, ADMFCN-180, ADMFCN-225, ADMFCP-135, ADMFCP-180, ADMFCP-225, ADMFCN-135, ADMFCN-180, ADMFCN-225, ADMFCP-135, ADMFCP-180, ADMFCP-225, ADMFCP-135-GR, ADMFCP-135HD, ADMFCP-135PC, ADMFCP-180, ADMFCP-180-GR, ADMFCP-180HDD, ADMFCP-180HHD, ADMFCP-180PC, ADMFCP-225, ADMFCP-225-GR, ADMFCP-225HDD, ADMFCP-225HHDD, ADMFCP-225HHHD, ADMFCP-225PC, CMFNCN-102-R, CMFNCN-135, CMFNCN-147-R, CMFNCN-180, CMFNCN-192-R, CMFNCN-225, CMFNCN-237-R, CMFNCN-270, CMFNP-102-R, CMFNP-135, CMFNP-135-BP, CMFNP-135F, CMFNP-135-GR, CMFNP-135HD, CMFNP-135PC, CMFNP-147-R, CMFNP-180, CMFNP-180-BP, CMFNP-180F, CMFNP-180-GR, CMFNP-180HDD, CMFNP-180HHD, CMFNP-180PC, CMFNP-192-R, CMFNP-225, CMFNP-225-BP...(Other models you can see in the webshop) |                 |                        |

Зип Общепит

vsezip.ru

1203 975 6027010079 (812) 987-08-81



|                    |  |                 |                        |
|--------------------|--|-----------------|------------------------|
| <b>GEV No.</b>     | 970883   | <b>Ref. No.</b> | 1203 975<br>6027010079 |
| <b>description</b> | grate W 460mm D 405mm H 10mm plastic-coated steel enamelled wire gauge frame 8mm lengthwise wires gauge 3mm crossing wires 2 grey  |                 |                        |
| <b>For models:</b> | CFMP-117-R, CFMP-117-RPC, CFMP-150, CFMP-150F, CFMP-150PC, CFMP-150TV, CFMP-169-R, CFMP-169-RPC, CFMP-202, CFMP-202F, CFMP-202PC, CFMP-202TV, CFMP-222-R, CFMP-222-RPC, CFMP-255, CFMP-255F, CFMP-255PC, CFMP-255TV, CFMP-307, CFMP-307F, CFMP-307TV, CMSN-117-R, CMSN-150, CMSN-169-R, CMSN-200, CMSN-222-R, CMSN-250, CMSN-300, CMSP-117-R, CMSP-150, CMSP-150F, CMSP-150HD, CMSP-150PC, CMSP-169-R, CMSP-200, CMSP-200F, CMSP-200HDD, CMSP-200HDD, CMSP-200PC, CMSP-222-R, CMSP-250, CMSP-250F, CMSP-250HDD, CMSP-250HDD, CMSP-250HDD, CMSP-250PC, CMSP-274-R, CMSP-300, CMSP-300F, FMP-117-R...(Other models you can see in the webshop) |                 |                        |



|                    |  |                 |            |
|--------------------|--|-----------------|------------|
| <b>GEV No.</b>     | 698838   | <b>Ref. No.</b> | 6027010009 |
| <b>description</b> | grate W 650mm D 530mm GN 2/1 H 10mm wire gauge frame 8mm lengthwise wires gauge 3mm crossing wires 2 grey  |                 |            |
| <b>For models:</b> | AEF-801AD, AEF-802AD, AEP-1602, AEP-1602AD, AEP-1603AD, AEP-1604AD, AEP-801, AEP-802, AF-1602-MIX, AF-1603-C, AF-1603-P, AF-1604-C, AF-1604-P, AF-802-C, AF-802-P, AFN-1602, AFN-1603, AFN-1604, AFN-801, AFN-802, AFP-1602, AFP-1602-2, AFP-1603, AFP-1603-2, AFP-1604, AFP-801, AFP-802, AFP-802-2, AFP-802-2C, AFP-802-3C, ANF-1602AD, ANF-1603AD, ANF-1604AD, ANF-801AD, ANF-802AD, APF-1602AD, APF-1603AD, APF-1604AD, APF-801AD, APF-802AD |                 |            |



|                    |  |                 |                        |
|--------------------|--|-----------------|------------------------|
| <b>GEV No.</b>     | 698837   | <b>Ref. No.</b> | 12034317<br>6027010087 |
| <b>description</b> | grate W 560mm D 540mm H 10mm wire gauge frame 8mm lengthwise wires gauge 3.5mm crossing wires 3 grey   |                 |                        |
| <b>For models:</b> | AEP-1402, AEP-2103, AEP-701, AF-1402-MIX, AF-1403-C, AF-1403-P, AF-1404-C, AF-1404-P, AF-2104-C, AF-2104-P, AF-2105-C, AF-2105-P, AF-2106-C, AF-2106-P, AF-702-C, AF-702-P, AFN-1402, AFN-1403, AFN-1404, AFN-701, AFN-702, AFP-1402, AFP-1403, AFP-1404, AFP-2103, AFP-2104, AFP-2105, AFP-2106, AFP-701, AFP-702, CAEP-1402, CAEP-2103, CAEP-701, CAF-1402MIX, CAF-1403C, CAF-1403P, CAF-1404C, CAF-1404P, CAF-2104C, CAF-2104P, CAF-2105C, CAF-2105P, CAF-2106C, CAF-2106P, CAF-702C, CAF-702P, CAFN-1402, CAFN-1403, CAFN-1404, CAFN-701...(Other models you can see in the webshop) |                 |                        |

producer-specific

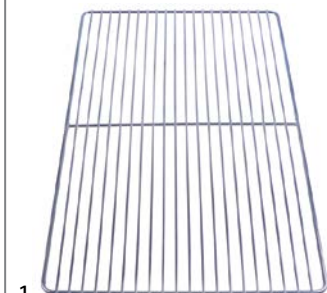

|                    |   |                 |                                |
|--------------------|---|-----------------|--------------------------------|
| <b>GEV No.</b>     | 970654  | <b>Ref. No.</b> | 12009267<br>U015630<br>U015631 |
| <b>description</b> | grate GN 1/1 W 325mm D 530mm H 8mm chrome-plated steel oven wire gauge frame 6mm lengthwise wires gauge 3mm crossing wires 1                                    |                 |                                |
| <b>For models:</b> | CG-1502, CG-210, CG-210G, CG-310, CG-310G, HCV-10-11, HCV-10-21, HCV-2-10-21, HCV-6-11, HE-10-11, HE-10-21, HE-2-10-11, HE-6-11, HG-10-11, HG-10-21, HG-2-10-11 |                 |                                |

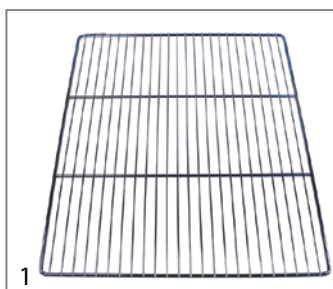

|                    |   |                 |  |
|--------------------|---|-----------------|--|
| <b>GEV No.</b>     | 970650  | <b>Ref. No.</b> | 12009338<br>12040318<br>U135635<br>U135642 |
| <b>description</b> | grate W 650mm D 530mm GN 2/1 chrome-plated steel wire gauge frame 8mm lengthwise wires gauge 3mm crossing wires 2   |                 |  |
| <b>For models:</b> | CE-410, CE7-41, CE7-41Q, CE9-41, CG-110, CG-2000, CG-2000-2P, CG7-11, CG-7115, CG7-31D, CG7-31I, CG7-41, CG-7415, CG7-41H, CG7-51, CG7-61, CG-7615, CG7-61H, CG9-11, CG-9110, CG9-41, CG9-51L, CG9-51LC, CG9-51R, CG9-51RC, CG9-61, CG9-82, CGE7-154, CGE7-41, CGE7-41H, CGE9-41, CGF9-121D, CGF9-121I, FI-5420, FI-7630, FTG9-11L, FTG9-11L+R, FTG9-11R, FTGC9-11L, FTGC9-11L+R, FTGC9-11R, HCV-10-21, HCV-2-10-21, HE9-10, HE9-20, HG9-10, HG9-20 |                 |  |

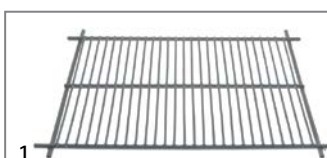

|                    |  |                 |                        |
|--------------------|--|-----------------|------------------------|
| <b>GEV No.</b>     | 970928   | <b>Ref. No.</b> | 12035775<br>6027010002 |
| <b>description</b> | grate W 424mm D 450mm H 14mm wire gauge frame 7mm lengthwise wires gauge 3.5mm crossing wires 1 grey   |                 |                        |
| <b>For models:</b> | FMP-117-R, FMP-150, FMP-169-R, FMP-202, FMP-222-R, FMP-255, FMP-274-R, FMP-307, MSN-117-R, MSN-150, MSN-169-R, MSN-200, MSN-222-R, MSN-250, MSN-274-R, MSN-300, MSP-117-R, MSP-150, MSP-150-2C, MSP-150-F, MSP-169-R, MSP-200, MSP-200-4C, MSP-200-F, MSP-222-R, MSP-250, MSP-250-F, MSP-274-R, MSP-300, MSP-300-F |                 |                        |





Зип Общепит  
grates

vsezip.ru

+7(812)987-08-81



|                    |   |                 |                        |
|--------------------|---|-----------------|------------------------|
| <b>GEV No.</b>     | 691858  | <b>Ref. No.</b> | 12035899<br>6027010017 |
| <b>description</b> | grate W 430mm D 160mm H 15mm plastic-coated steel refrigeration wire gauge frame 7.4mm lengthwise wires gauge 2.8mm crossing wires 1 grey with holder   |                 |                        |
| <b>For models:</b> | AEP-1402, AEP-2103, AF-1403-C, AF-1403-P, AF-1404-C, AF-1404-P, AF-2104-C, AF-2104-P, AF-2105-C, AF-2105-P, AF-2106-C, AF-2106-P, AFN-1402, AFN-1403, AFN-1404, AFP-1402, AFP-1403, AFP-1404, AFP-1404-USMC, AFP-2103, AFP-2104, AFP-2105, AFP-2106 |                 |                        |



|                    |  |                 |                        |
|--------------------|--|-----------------|------------------------|
| <b>GEV No.</b>     | 970761   | <b>Ref. No.</b> | 12037978<br>6027010016 |
| <b>description</b> | grate W 525mm D 565mm plastic-coated steel   |                 |                        |
| <b>For models:</b> | AEP-1402, AEP-2103, AEP-701, AF-1402-MIX, AF-1403-C, AF-1403-P, AF-1404-C, AF-1404-P, AF-2104-C, AF-2104-P, AF-2105-C, AF-2105-P, AF-2106-C, AF-2106-P, AF-702-C, AF-702-P, AFN-1402, AFN-1403, AFN-1404, AFN-702, AFP-1402, AFP-1403, AFP-1404, AFP-1404-USMC, AFP-2103, AFP-2104, AFP-2105, AFP-2106, AFP-701, AFP-702 |                 |                        |



|                    |   |                 |                        |
|--------------------|---|-----------------|------------------------|
| <b>GEV No.</b>     | 691859  | <b>Ref. No.</b> | 12032755<br>6027010052 |
| <b>description</b> | grate W 826mm D 334mm H 25mm plastic-coated steel refrigeration wire gauge frame 6.5mm lengthwise wires gauge 3.4mm crossing wires 1 grey with hinge camp |                 |                        |
| <b>For models:</b> | ERM-250, ERMS-250   |                 |                        |



|                    |  |                 |                     |
|--------------------|--|-----------------|---------------------|
| <b>GEV No.</b>     | 970651   | <b>Ref. No.</b> | 12009381<br>U065624 |
| <b>description</b> | grate W 855mm D 535mm chrome-plated steel with hinge camp wire gauge frame 8mm lengthwise wires gauge 4mm crossing wires 2 |                 |                     |
| <b>For models:</b> | CGB7-61, CGB7-61H, CGB7-61R, CGB7-61RH   |                 |                     |



|                    |  |                 |                     |
|--------------------|--|-----------------|---------------------|
| <b>GEV No.</b>     | 691713   | <b>Ref. No.</b> | 12004675<br>H125404 |
| <b>description</b> | chimney grate L 350mm W 75mm H 100mm SS  |                 |                     |
| <b>For models:</b> | BG7-05, BG7-05I, CE7-20, CG7-20, CG7-20H, CPE7-05, CPE7-05NC, CPG7-05, CPG7-05NC, EN7-05, FG7-05-1C, FG7-05-2C, FG7-10-2C, FG7-104C, FG7-10-4C, FTE7-05L, FTE7-05R, FTEC7-05L, FTG7-05L, FTG7-05R, FTG7-05VL, FTG7-05VR, FTGC7-05L |                 |                     |



|                    |   |                 |                     |
|--------------------|---|-----------------|---------------------|
| <b>GEV No.</b>     | 691843  | <b>Ref. No.</b> | 12007683<br>R205425 |
| <b>description</b> | chimney grate L 425mm W 101mm H 22mm  |                 |                     |
| <b>For models:</b> | BG9-05, BG9-05AD, BG9-05I, BG9-05PF, BG9-05PI, BG9-05PLUS-I, BG9-10, BG9-10AD, BG9-10I, BG9-10PF, BG9-10PI, BG9-10PLUS-I, BME9-05, BME9-05AD, BME9-05PLUS, BME9-05V-T, BME9-10, BME9-10AD, BME9-10PLUS, BME9-10V-T, BMG9-05, BMG9-05V-T, BMG9-10, BMG9-10V-T, CE9-20, CE9-20AD, CE9-20PLUS, CE9-40, CE9-40AD, CE9-40PLUS, CE9-41, CE9-41AD, CE9-41PLUS, CG9-05AD, CG9-05PLUS, CG9-10, CG9-10AD, CG9-10PLUS, CG9-11, CG9-11AD, CG9-11PLUS, CG9-20, CG9-20AD, CG9-20AD-H, CG9-20H, CG9-20PLUS, CG9-20PLUS-H, CG9-31PLUS-D, CG9-31PLUS-I, CG9-40...(Other models you can see in the webshop) |                 |                     |



|                    |   |                 |                     |
|--------------------|---|-----------------|---------------------|
| <b>GEV No.</b>     | 691720  | <b>Ref. No.</b> | 12005077<br>S565401 |
| <b>description</b> | chimney grate L 700mm W 75mm H 90mm SS  |                 |                     |
| <b>For models:</b> | BG7-10, BG7-10I, CE7-40, CE7-41, CG7-10, CG7-11, CG7-30D, CG7-30I, CG7-31D, CG7-31I, CG7-40, CG7-40H, CG7-41, CG7-41H, CGE7-41, CGE7-41H, EN7-10, FTE7-10L, FTE7-10L+R, FTE7-10R, FTEC7-10L, FTG7-10L, FTG7-10L+R, FTG7-10R, FTG7-10VL, FTG7-10VL+R, FTG7-10VR, FTGC7-10L, ME7-10BM, MG7-10, MG7-10BM, MV7-10BM, SBE7-10, SBG7-10 |                 |                     |

grid attachments

Зип Общепит

vsezip.ru

+7(812)987-08-81



|                    |   |                 |                     |
|--------------------|---|-----------------|---------------------|
| <b>GEV No.</b>     | 691906  | <b>Ref. No.</b> | 12011674<br>R662670 |
| <b>description</b> | rack support mounting pos. left L 380mm H 400mm stainless steel suitable for 6/11 |                 |                     |
| <b>For models:</b> | HCG-6-11, HME-6-11, HMI-6-11, HMI-6-11UL, HMM-6-11, HMM-6-11UL, HMP-6-11          |                 |                     |



|                    |   |                 |                     |
|--------------------|---|-----------------|---------------------|
| <b>GEV No.</b>     | 691918  | <b>Ref. No.</b> | 12012088<br>T122616 |
| <b>description</b> | rack support mounting pos. left L 585mm H 635mm W 40mm stainless steel suitable for 10/21 |                 |                     |
| <b>For models:</b> | HCG-10-21, HME-10-21, HMI-10-21, HMM-10-21, HMP-10-21, HVG-10-21                          |                 |                     |



|                    |   |                 |                                 |
|--------------------|---|-----------------|---------------------------------|
| <b>GEV No.</b>     | 691909  | <b>Ref. No.</b> | 12012692<br>12022802<br>R662645 |
| <b>description</b> | rack support mounting pos. left L 380mm H 400mm stainless steel suitable for HEI 6/11 HMI 6/11  |                 |                                 |
| <b>For models:</b> | COE-061, COG-061, HCG-6-11, HEI-6-11, HEM-6-11, HEP-6-11, HGC-6-11, HME-6-11, HMG-6-11, HMI-6-11, HMI-6-11UL, HMM-10-11, HMM-10-11UL, HMM-6-11, HMM-6-11UL, HMP-6-11, VE-061, VPE-061 |                 |                                 |



|                    |  |                 |                     |
|--------------------|--|-----------------|---------------------|
| <b>GEV No.</b>     | 691907   | <b>Ref. No.</b> | 12013088<br>R662668 |
| <b>description</b> | rack support mounting pos. right L 380mm H 400mm stainless steel suitable for 6/11 |                 |                     |
| <b>For models:</b> | HCG-6-11, HME-6-11, HMI-6-11, HMI-6-11UL, HMM-6-11, HMM-6-11UL, HMP-6-11           |                 |                     |



|                    |  |                 |                                |
|--------------------|--|-----------------|--------------------------------|
| <b>GEV No.</b>     | 691921   | <b>Ref. No.</b> | 12012184<br>R672646<br>T112617 |
| <b>description</b> | rack support mounting pos. left L 380mm H 635mm W 40mm stainless steel suitable for 10/11  |                 |                                |
| <b>For models:</b> | HCG-10-11, HME-10-11, HMG-10-11, HMI-10-11, HMI-10-11UL, HMM-10-11, HMM-10-11UL, HMP-10-11, HVG-10-11, HVG-10-11UL, HVG-2-10-11, MFHVG-10-11 |                 |                                |



|                    |   |                 |                                 |
|--------------------|---|-----------------|---------------------------------|
| <b>GEV No.</b>     | 691908  | <b>Ref. No.</b> | 12014126<br>12022801<br>R662646 |
| <b>description</b> | rack support mounting pos. right L 380mm H 400mm stainless steel suitable for HEI 6/11 HMI 6/11   |                 |                                 |
| <b>For models:</b> | COE-061, COG-061, HCG-6-11, HEI-6-11, HEM-6-11, HEP-6-11, HGC-6-11, HME-6-11, HMG-6-11, HMI-6-11, HMI-6-11UL, HMM-10-11, HMM-10-11UL, HMM-6-11, HMM-6-11UL, HMP-6-11, VE-061, VPE-061 |                 |                                 |





Зип Общепит  
vsezip.ru  
+7(812)987-08-81

|  |  |                 |                                |
|--|--|-----------------|--------------------------------|
|  <p>1</p> |  |                 |                                |
| <b>GEV No.</b>   | 691920   | <b>Ref. No.</b> | 12012759<br>R672645<br>T112615 |
| <b>description</b>   | rack support mounting pos. right L 380mm H 635mm W 40mm stainless steel suitable for 10/11   |                 |                                |
| <b>For models:</b>   | HCG-10-11, HME-10-11, HMG-10-11, HMI-10-11, HMI-10-11UL, HMM-10-11, HMM-10-11UL, HMP-10-11, HVG-10-11, HVG-10-11UL, HVG-2-10-11, MFHVG-10-11 |                 |                                |

|   |   |                 |                     |
|---|---|-----------------|---------------------|
|  <p>1</p> |   |                 |                     |
| <b>GEV No.</b>  | 700837  | <b>Ref. No.</b> | 12022577<br>R672668 |
| <b>description</b>  | guide L-shape L 390mm W 24mm H 114mm mounting pos. left |                 |                     |

|  |  |                 |                     |
|--|--|-----------------|---------------------|
|  <p>1</p> |  |                 |                     |
| <b>GEV No.</b>   | 691919   | <b>Ref. No.</b> | 12011984<br>T122614 |
| <b>description</b>   | rack support mounting pos. right L 585mm H 635mm W 40mm stainless steel suitable for 10/21 |                 |                     |
| <b>For models:</b>   | HCG-10-21, HME-10-21, HMI-10-21, HMM-10-21, HMP-10-21, HVG-10-21                           |                 |                     |

|   |  |                 |                     |
|---|--|-----------------|---------------------|
|  <p>1</p> |  |                 |                     |
| <b>GEV No.</b>  | 700838   | <b>Ref. No.</b> | 12022578<br>R672669 |
| <b>description</b>  | guide L-shape L 390mm W 24mm H 114mm mounting pos. right |                 |                     |

|   |   |                 |  |
|---|---|-----------------|--|
|  <p>1</p> |   |                 |  |
| <b>GEV No.</b>  | 692123  | <b>Ref. No.</b> | 12036419<br>12037055<br>6003001006<br>6033050014 |
| <b>description</b>  | guide L-shape L 648mm W 15mm H 23mm mounting pos. left/right  |                 |  |
| <b>For models:</b>  | CMMZ-150, CMMZ-202, CMPN-117-R, CMPN-150, CMPN-169-R, CMPN-202, CMPN-222-R, CMPN-255, CMPP-117-R, CMPP-150, CMPP-150-C, CMPP-169-R, CMPP-202, CMPP-202-C, CMPP-222-R, CMPP-255, CMPP-255-C, CMPP-307, MMZ-150, MMZ-202, MPN-117-R, MPN-150, MPN-169-R, MPN-202, MPN-222-R, MPN-255, MPN-274-R, MPN-307, MPP-117-R, MPP-117-R-G, MPP-150, MPP-150-G, MPP-169-R, MPP-169-R-G, MPP-202, MPP-202-G, MPP-222-R, MPP-222-R-G, MPP-255, MPP-255-G, MPP-274-R, MPP-274-R-G, MPP-307, MPP-307-G, MPP-307-R, MPZ-150, MPZ-202 |                 |  |

shelf rails and supports

producer-specific

|  |   |                 |                        |
|--|---|-----------------|------------------------|
|  <p>1</p> |   |                 |                        |
| <b>GEV No.</b>   | 701568  | <b>Ref. No.</b> | 12037936<br>6033050015 |
| <b>description</b>   | guide L 562mm W 16mm H 25.5mm mounting pos. left/right  |                 |                        |
| <b>For models:</b>   | ADAEP-1602, ADAFN-1602, ADAFP-1602, AEP-1602AD, AEP-1603AD, AEP-1604AD, AF-1403-C, AF-1404-C, AF-1603-C, AF-1604-C, AF-2104-C, AF-2105-C, AF-2106-C, AF-702-C, AFP-702, ANF-1602AD, ANF-1603AD, ANF-1604AD, APF-1602AD, APF-1603AD, APF-1604AD, CAF-1403C, CAF-1404C, CAF-2104P, CAF-2105P, CAF-2106P, CAF-702C, CMFN-102-R, CMFN-135, CMFN-147-R, CMFN-180, CMFN-192-R, CMFN-225, CMFN-237-R, CMFN-270, CMFP-102-R, CMFP-135, CMFP-135-BP, CMFP-135F, CMFP-135-GR, CMFP-135HD, CMFP-135PC, CMFP-147-R, CMFP-180, CMFP-180-BP, CMFP-180F, CMFP-180-GR, CMFP-180HDD, CMFP-180HHD, CMFP-180PC...(Other models you can see in the webshop) |                 |                        |

|   |   |                 |  |
|---|---|-----------------|--|
|  <p>1</p> |   |                 |  |
| <b>GEV No.</b>  | 692110  | <b>Ref. No.</b> | 12036758<br>12036819<br>12037054<br>6009990002<br>6009990037<br>6033050011 |
| <b>description</b>  | guide U-shape L 549mm W 15mm H 22mm mounting pos. left/right  |                 |  |
| <b>For models:</b>  | MCN-102-GN-R, MCN-135-GN, MCN-147-GN-R, MCN-180-GN, MCN-192-GN-R, MCN-225-GN, MCN-237-GN-R, MCN-270-GN, MCP-102-GN-R, MCP-135-GN, MCP-147-GN-R, MCP-180-GN, MCP-192-GN-R, MCP-225-GN, MCP-237-GN-R, MCP-270-GN, MEP-100, MEP-100G, MEP-135, MEP-180, MFN-102-GN-R, MFN-102-R, MFN-135, MFN-135-GN, MFN-147-GN-R, MFN-147-R, MFN-180, MFN-180-GN, MFN-192-GN-R, MFN-192-R, MFN-225, MFN-225-GN, MFN-237-GN-R, MFN-237-R, MFN-270, MFN-270-GN, MFP-102-2C, MFP-102-GN-R, MFP-135, MFP-135-2C, MFP-135-F, MFP-135-GN, MFP-147-2C, MFP-147-4C, MFP-147-GN-R, MFP-180, MFP-180-2C, MFP-180-4C, MFP-180-F, MFP-180-GN...(Other models you can see in the webshop) |                 |  |

Зип Общепит

vsezip.ru

+7(812)987-08-81



1

|                    |  |                 |  |
|--------------------|--|-----------------|--|
| <b>GEV No.</b>     | 700884   | <b>Ref. No.</b> | 12036565<br>12036836<br>12037948<br>6009990004<br>6009990064<br>6033050016 |
| <b>description</b> | guide U-shape L 662mm W 15mm mounting pos. left/right inner height 22mm  |                 |  |
| <b>For models:</b> | AEP-1602, AEP-1603, AEP-1604, AEP-801, AEP-802, AF-1602-MIX, AF-1603-C, AF-1603-P, AF-1604-C, AF-1604-P, AF-802-C, AF-802-P, AFN-1602, AFN-1603, AFN-1604, AFN-801, AFN-802, AFP-1602, AFP-1602-2, AFP-1603, AFP-1603-2, AFP-1604, AFP-801, AFP-802, AFP-802-2, AFP-802-2C, AFP-802-3C, CAEP-1602, CAEP-801, CAEP-802, CAF-1602MIX, CAF-1603-C, CAF-1603-P, CAF-1604-C, CAF-1604-P, CAF-802-C, CAF-802-P, CAFN-1602, CAFN-1603, CAFN-1604, CAFN-801, CAFN-802, CAFP-1602, CAFP-1602-2, CAFP-1603, CAFP-1603-2, CAFP-1604, CAFP-801, CAFP-802, CAFP-802-2...(Other models you can see in the webshop) |                 |  |



1

|                    |  |                 |            |
|--------------------|--|-----------------|------------|
| <b>GEV No.</b>     | 692663   | <b>Ref. No.</b> | 6033050025 |
| <b>description</b> | pair of setting bar L 662mm W 15mm H 24mm mounting pos. left/right |                 |            |



1

|                    |  |                 |            |
|--------------------|--|-----------------|------------|
| <b>GEV No.</b>     | 692662   | <b>Ref. No.</b> | 6033050028 |
| <b>description</b> | pair of setting bar L 549mm W 15mm H 24mm mounting pos. left/right |                 |            |



1

|                    |   |                 |  |
|--------------------|---|-----------------|--|
| <b>GEV No.</b>     | 700815  | <b>Ref. No.</b> | 12037855<br>12090875<br>2021500320<br>6003010124 |
| <b>description</b> | shelf support for grate L 26mm W 20mm H 23mm plastic for fridge   |                 |  |
| <b>For models:</b> | BFP-100, BFP-100A, BFP-100I, BFP-150, BFP-150A, BFP-150I, BFP-200, BFP-200A, BFP-200I, BFP-250, BFP-250A, BFP-250I, BFP-300, BFP-300I |                 |  |



1

|                    |   |                 |            |
|--------------------|---|-----------------|------------|
| <b>GEV No.</b>     | 692660  | <b>Ref. No.</b> | 6033050027 |
| <b>description</b> | pair of setting bar L 562mm W 15mm mounting pos. left/right mounting distance 525mm hook width 12mm inner height 24mm |                 |            |



1

|                    |   |                 |                     |
|--------------------|---|-----------------|---------------------|
| <b>GEV No.</b>     | 691887  | <b>Ref. No.</b> | 12021988<br>Z712509 |
| <b>description</b> | shelf support L 28mm W 20mm H 15mm SS   |                 |                     |
| <b>For models:</b> | ECO-120, ECO-120B, FI-100, FI-100AR, FI-100B, FI-120, FI-120B, FI-120W, FI-80, FI-80W, MF-120 |                 |                     |



1

|                    |  |                 |            |
|--------------------|--|-----------------|------------|
| <b>GEV No.</b>     | 692661   | <b>Ref. No.</b> | 6033050029 |
| <b>description</b> | pair of setting bar L 613mm W 15mm H 24mm mounting pos. left/right |                 |            |



1

|                    |                                    |                 |            |
|--------------------|------------------------------------|-----------------|------------|
| <b>GEV No.</b>     | 698843                             | <b>Ref. No.</b> | 6033210019 |
| <b>description</b> | shelf support L 42mm W 22mm H 27mm |                 |            |



**gaskets**

refrigeration gaskets

plug-in gaskets

profile 9013

We offer custom-made gaskets for this profile

Зип Общепит

vsezip.ru

+7(812)987-08-81

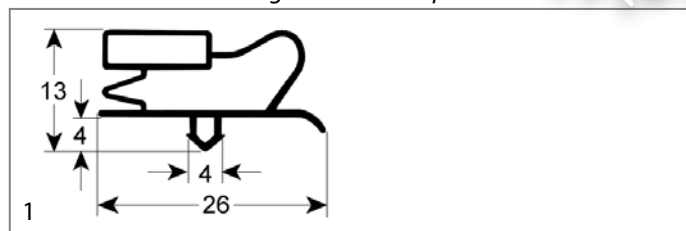

|                    |  |                 |          |
|--------------------|--|-----------------|----------|
| <b>GEV No.</b>     | 901764   | <b>Ref. No.</b> | 12034906 |
| <b>description</b> | refrigeration gasket profile 9013 W 1503mm L 685mm plug size |                 |          |

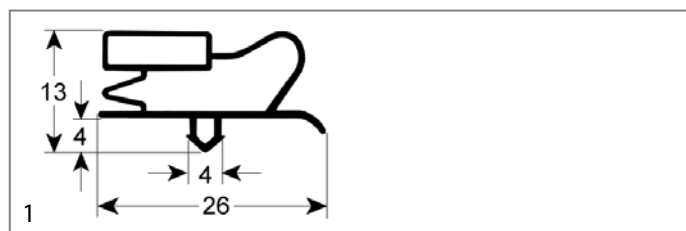

|                    |   |                 |                        |
|--------------------|---|-----------------|------------------------|
| <b>GEV No.</b>     | 900902  | <b>Ref. No.</b> | 12035763<br>6045010020 |
| <b>description</b> | refrigeration gasket profile 9013 W 155mm L 375mm plug size |                 |                        |

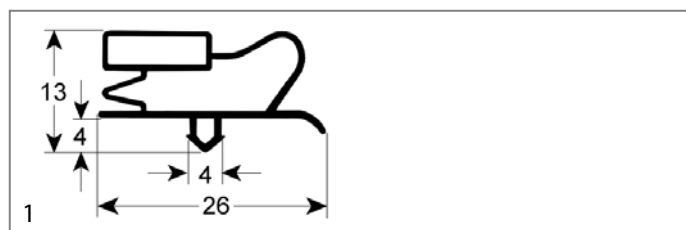

|                    |   |                 |  |
|--------------------|---|-----------------|--|
| <b>GEV No.</b>     | 900910  | <b>Ref. No.</b> | 12035439<br>12035723<br>6001401119<br>6045010024 |
| <b>description</b> | refrigeration gasket profile 9013 W 155mm L 450mm plug size   |                 |  |
| <b>For models:</b> | MSN-117-R, MSN-150, MSN-169-R, MSN-200, MSN-222-R, MSN-250, MSN-274-R, MSN-300, MSP-117-R, MSP-150, MSP-150-F, MSP-169-R, MSP-200, MSP-200-F, MSP-222-R, MSP-250, MSP-250-F, MSP-274-R, MSP-300 |                 |  |

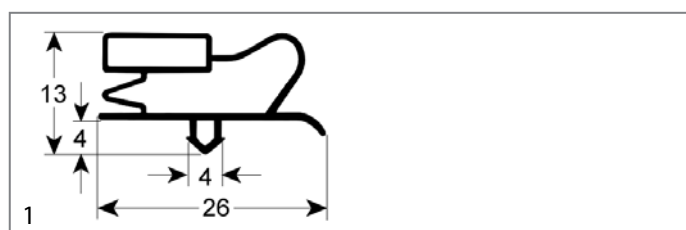

|                    |  |                 |                        |
|--------------------|--|-----------------|------------------------|
| <b>GEV No.</b>     | 901529   | <b>Ref. No.</b> | 12036161<br>6045010122 |
| <b>description</b> | refrigeration gasket profile 9013 W 245mm L 370mm plug size  |                 |                        |
| <b>For models:</b> | CMFP-135HD, CMFP-135HH, CMFP-180HDD, CMFP-180HHD, CMFP-180HHH, CMFP-225HDDD, CMFP-225HHDD, CMFP-225HHHD, CMFP-225HHHH, MFP-102-R2C-GN, MFP-102-R4C-GN, MFP-135-2C-GN, MFP-135-4C-GN, MFP-147-R2C-GN, MFP-147-R4C-GN, MFP-147-R6C-GN, MFP-180-2C-GN, MFP-180-4C-GN, MFP-180-6C-GN, MFP-192-R2C-GN, MFP-192-R4C-GN, MFP-192-R6C-GN, MFP-192-R8C-GN, MFP-225-2C-GN, MFP-225-4C-GN, MFP-225-6C-GN, MFP-225-8C-GN, MFP-237-R2C-GN, MFP-237-R6C-GN, MFP-237-R8C-GN, MFP-270-10C-GN, MFP-270-2C-GN, MFP-270-4C-GN, MFP-270-6C-GN, MFP-270-8C-GN |                 |                        |

|                    |  |                 |  |
|--------------------|--|-----------------|--|
| <b>GEV No.</b>     | 900880   | <b>Ref. No.</b> | 12034834<br>12036435<br>6001401107<br>6045010012 |
| <b>description</b> | refrigeration gasket profile 9013 W 255mm L 375mm plug size  |                 |  |
| <b>For models:</b> | MCN-102-GN-R, MCN-135-GN, MCN-147-GN-R, MCN-180-GN, MCN-192-GN-R, MCN-225-GN, MCN-237-GN-R, MCN-270-GN, MCP-102-GN-R, MCP-135-GN, MCP-147-GN-R, MCP-180-GN, MCP-192-GN-R, MCP-225-GN, MCP-237-GN-R, MCP-270-GN, MFN-102-GN-R, MFN-135-GN, MFN-147-GN-R, MFN-180-GN, MFN-192-GN-R, MFN-225-GN, MFN-237-GN-R, MFN-270-GN, MFP-102-GN-R, MFP-135-2C, MFP-135-4C, MFP-135-GN, MFP-147-GN-R, MFP-180-2C, MFP-180-4C, MFP-180-6C, MFP-180-GN, MFP-192-2C, MFP-192-4C, MFP-192-6C, MFP-192-8C, MFP-192-GN-R, MFP-225-2C, MFP-225-4C, MFP-225-6C, MFP-225-8C, MFP-225-GN, MFP-237-10C, MFP-237-4C, MFP-237-6C, MFP-237-8C, MFP-237-GN-R, MFP-270-10C, MFP-270-2C...(Other models you can see in the webshop) |                 |  |

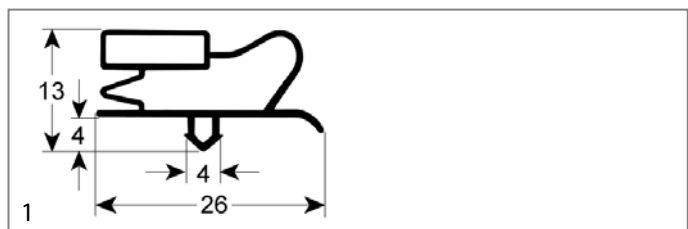

|                    |   |                 |  |
|--------------------|---|-----------------|--|
| <b>GEV No.</b>     | 900911  | <b>Ref. No.</b> | 12035440<br>12035441<br>6001401102<br>6045010007 |
| <b>description</b> | refrigeration gasket profile 9013 W 380mm L 400mm plug size |                 |  |
| <b>For models:</b> | MEP-100, MEP-100G   |                 |  |

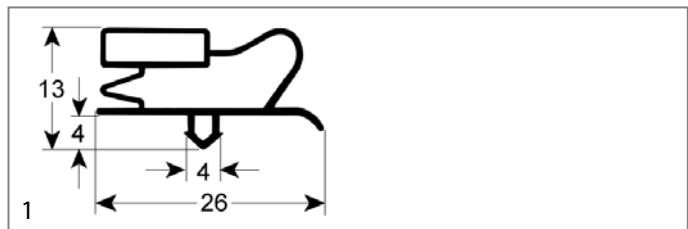

|                    |   |                 |                                      |
|--------------------|---|-----------------|--------------------------------------|
| <b>GEV No.</b>     | 901180  | <b>Ref. No.</b> | 12035974<br>6001401101<br>6045010006 |
| <b>description</b> | refrigeration gasket profile 9013 W 380mm L 585mm plug size   |                 |                                      |
| <b>For models:</b> | MCN-102-GN-R, MCN-102-R, MCN-135, MCN-135-GN, MCN-147-GN-R, MCN-147-R, MCN-180, MCN-180-GN, MCN-192-GN-R, MCN-192-R, MCN-225, MCN-225-GN, MCN-237-GN-R, MCN-237-R, MCN-270, MCN-270-GN, MCP-102-GN-R, MCP-135, MCP-135-GN, MCP-147-GN-R, MCP-180, MCP-180-GN, MCP-192-GN-R, MCP-225, MCP-225-GN, MCP-237-GN-R, MCP-270-GN, MEP-135, MEP-180, MFN-102-GN-R, MFN-102-R, MFN-135, MFN-135-GN, MFN-147-GN-R, MFN-147-R, MFN-180, MFN-180-GN, MFN-192-GN-R, MFN-192-R, MFN-225, MFN-225-GN, MFN-237-GN-R, MFN-237-R, MFN-270, MFN-270-GN, MFP-102-2C, MFP-102-GN-R, MFP-135, MFP-135-2C, MFP-135-F...(Other models you can see in the webshop) |                 |                                      |

mechanical components, equipment accessories

Зип Общепит

vsezip.ru

+7(812)987-08-81

|                    |   |                 |          |
|--------------------|---|-----------------|----------|
| <b>GEV No.</b>     | 901765  | <b>Ref. No.</b> | 12036345 |
| <b>description</b> | refrigeration gasket profile 9013 W 450mm L 260mm plug size |                 |          |

|                    |   |                 |  |
|--------------------|---|-----------------|--|
| <b>GEV No.</b>     | 900893  | <b>Ref. No.</b> | 12034290<br>12035834<br>6001401104<br>6045010009 |
| <b>description</b> | refrigeration gasket profile 9013 W 450mm L 580mm plug size |                 |  |

**For models:** MMZ-150, MMZ-202, MPN-117-C, MPN-117-R, MPN-117-R-C, MPN-150, MPN-150-C, MPN-169-C, MPN-169-R, MPN-169-R-C, MPN-202, MPN-202-C, MPN-222-C, MPN-222-R, MPN-222-R-C, MPN-255, MPN-255-C, MPN-274-C, MPN-274-R, MPN-274-R-C, MPN-307, MPN-307-C, MPP-117-C, MPP-117-C-G, MPP-117-R, MPP-117-R-C, MPP-117-R-G, MPP-150, MPP-150-C, MPP-150-C-G, MPP-150-G, MPP-169-C, MPP-169-C-G, MPP-169-R, MPP-169-R-C, MPP-169-R-G, MPP-202, MPP-202-C, MPP-202-C-G, MPP-202-G, MPP-222-C, MPP-222-C-G, MPP-222-R, MPP-222-R-C, MPP-222-R-G, MPP-255, MPP-255-C, MPP-255-C-G, MPP-255-G, MPP-274-C...(Other models you can see in the webshop)

|                    |   |                 |  |
|--------------------|---|-----------------|--|
| <b>GEV No.</b>     | 900907  | <b>Ref. No.</b> | 12034473<br>12035547<br>6001401113<br>6045010018 |
| <b>description</b> | refrigeration gasket profile 9013 W 455mm L 770mm plug size   |                 |  |
| <b>For models:</b> | FMP-117-R, FMP-150, FMP-169-R, FMP-200, FMP-202, FMP-222-R, FMP-250, FMP-255, FMP-274-R, FMP-300, FMP-307 |                 |  |

|                    |  |                 |  |
|--------------------|--|-----------------|--|
| <b>GEV No.</b>     | 900903   | <b>Ref. No.</b> | 12033951<br>12035400<br>6001401108<br>6045010013 |
| <b>description</b> | refrigeration gasket profile 9013 W 615mm L 710mm plug size  |                 |  |
| <b>For models:</b> | AEP-1602, AEP-802, AF-1403-C, AF-1403-P, AF-1404-C, AF-1404-P, AF-1603-C, AF-1603-P, AF-1604-C, AF-1604-P, AF-2104-C, AF-2104-P, AF-2105-C, AF-2105-P, AF-2106-C, AF-2106-P, AF-702-C, AF-702-P, AF-802-P, AFN-1402, AFN-1403, AFN-1404, AFN-1603, AFN-1604, AFN-702, AFN-802, AFP-1403, AFP-1403-C, AFP-1403-FORZ, AFP-1403-P, AFP-1404, AFP-1404-C, AFP-1404-FORZ, AFP-1404-P, AFP-1404-USMC, AFP-1603, AFP-1603-2, AFP-1604, AFP-2104, AFP-2104-C, AFP-2104-P, AFP-2105, AFP-2105-C, AFP-2105-P, AFP-2106, AFP-2106-C, AFP-2106-P, AFP-702, AFP-702-C, AFP-702-FORZ...(Other models you can see in the webshop) |                 |  |

|                    |   |                 |  |
|--------------------|---|-----------------|--|
| <b>GEV No.</b>     | 900028  | <b>Ref. No.</b> | 12034015<br>12034625<br>6010220002<br>6045010002 |
| <b>description</b> | refrigeration gasket profile 9013 W 618mm L 1500mm plug size door |                 |  |

|                    |   |                 |          |
|--------------------|---|-----------------|----------|
| <b>GEV No.</b>     | 901580  | <b>Ref. No.</b> | 12035207 |
| <b>description</b> | refrigeration gasket profile 9013 W 618mm L 722mm plug size with magnet |                 |          |

|                    |  |                 |  |
|--------------------|--|-----------------|--|
| <b>GEV No.</b>     | 900906   | <b>Ref. No.</b> | 12034170<br>12034292<br>6001401111<br>6045010016 |
| <b>description</b> | refrigeration gasket profile 9013 W 683mm L 1501mm plug size |                 |  |
| <b>For models:</b> | AP-701, APP-701  |                 |  |

Зип Общепит

vsezip.ru

+7(812)987-08-81

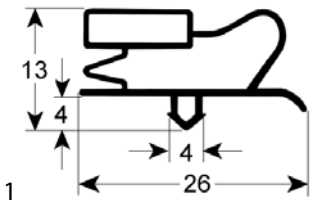

|                    |  |                 |     |
|--------------------|--|-----------------|-----|
| <b>GEV No.</b>     | 902028   | <b>Ref. No.</b> | N/A |
| <b>description</b> | refrigeration gasket profile 9013 Wmm L 2500mm |                 |     |



|                    |   |                 |  |
|--------------------|---|-----------------|--|
| <b>GEV No.</b>     | 901181  | <b>Ref. No.</b> | 12036036<br>12036158<br>6045010120<br>6045010152 |
| <b>description</b> | refrigeration gasket profile 9797 W 350mm L 370mm plug size |                 |  |

profile 9797

We offer custom-made gaskets for this profile

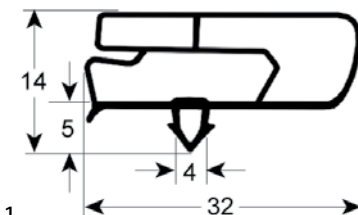

|                    |  |                 |                        |
|--------------------|--|-----------------|------------------------|
| <b>GEV No.</b>     | 901763   | <b>Ref. No.</b> | 12038148<br>6045010131 |
| <b>description</b> | refrigeration gasket profile 9797 W 1435mm L 615mm plug size |                 |                        |

**For models:**

AEP-1402, AEP-1602, AEP-2103, AEP-701, AEP-801, AF-1402-MIX, AF-1403-C, AF-1403-P, AF-1602-MIX, AF-1603-C, AF-1603-P, AF-1604-C, AF-1604-P, AF-2104-C, AF-2104-P, AF-2105-C, AF-2105-P, AFN-1402, AFN-1403, AFN-1602, AFN-1603, AFN-1604, AFN-701, AFN-801, AFP-1402, AFP-1403, AFP-1602, AFP-1602-2, AFP-1603, AFP-1603-2, AFP-1604, AFP-2103, AFP-2104, AFP-2105, AFP-701, AFP-801, CAEP-1402, CAEP-1602, CAEP-2103, CAEP-701, CAEP-801, CAF-1402MIXT, CAF-1403C, CAF-1403P, CAF-1602MIX, CAF-1603-C, CAF-1603-P, CAF-2104C, CAF-2104P, CAF-2105C...(Other models you can see in the webshop)

**For models:**

CMFP-135-B, CMFP-135-B2, CMFP-135-BP, CMFP-180-B, CMFP-180-B2, CMFP-180-BP, CMFP-225-B, CMFP-225-B2, CMFP-225-BP, CMFP-270-B, CMFP-270-B2, CMFP-270-BP, MEP-100, MEP-100G, MFP-102-R2C-GN, MFP-102-R4C-GN, MFP-135-2C-GN, MFP-135-4C-GN, MFP-135-B, MFP-135-B2-GN, MFP-135-B-GN, MFP-135-BP-GN, MFP-147-R2C-GN, MFP-147-R4C-GN, MFP-147-R6C-GN, MFP-180-2C-GN, MFP-180-4C-GN, MFP-180-6C-GN, MFP-180-B, MFP-180-B2-GN, MFP-180-B-GN, MFP-180-BP-GN, MFP-192-R2C-GN, MFP-192-R4C-GN, MFP-192-R6C-GN, MFP-192-R8C-GN, MFP-225-2C-GN, MFP-225-4C-GN, MFP-225-6C-GN, MFP-225-8C-GN, MFP-225-B, MFP-225-B2-GN, MFP-225-B-GN, MFP-225-BP-GN, MFP-237-R2C-GN, MFP-237-R6C-GN, MFP-237-R8C-GN, MFP-270-10C-GN, MFP-270-2C-GN, MFP-270-4C-GN...(Other models you can see in the webshop)

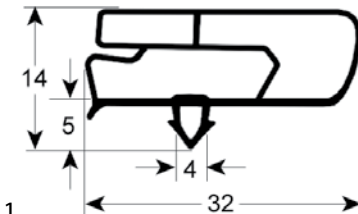

|                    |  |                 |                                    |
|--------------------|--|-----------------|------------------------------------|
| <b>GEV No.</b>     | 901759   | <b>Ref. No.</b> | 12034580<br>12057676<br>6045010050 |
| <b>description</b> | refrigeration gasket profile 9797 W 1680mm L 580mm plug size |                 |                                    |

**For models:**

CMFN-102-R, CMFN-135, CMFN-147-R, CMFN-180, CMFN-192-R, CMFN-225, CMFN-237-R, CMFN-270, CMFP-102-R, CMFP-135, CMFP-135F, CMFP-135-GR, CMFP-135HD, CMFP-135PC, CMFP-147-R, CMFP-180, CMFP-180F, CMFP-180-GR, CMFP-180HDD, CMFP-180HHD, CMFP-180PC, CMFP-192-R, CMFP-225, CMFP-225F, CMFP-225-GR, CMFP-225HDDD, CMFP-225HHDD, CMFP-225HHHD, CMFP-225PC, CMFP-237-R, CMFP-270, CMMZ-180-7, CMMZ-225-7, CMPZ1-135, CMPZ1-180, MCN-135-GN, MCN-180-GN, MCN-270-GN, MCP-135-GN, MCP-147-GN-R, MCP-180-GN, MCP-192-GN-R, MCP-225-GN, MCP-237-GN-R, MCP-270-GN, MEP-135, MEP-135-GN, MEP-180, MEP-180-GN, MFN-135...(Other models you can see in the webshop)

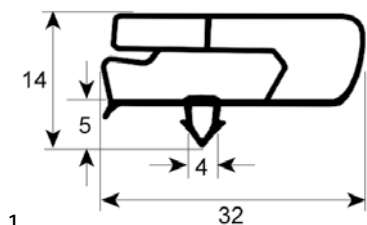

|                    |   |                 |                        |
|--------------------|---|-----------------|------------------------|
| <b>GEV No.</b>     | 901164  | <b>Ref. No.</b> | 12038156<br>6045010119 |
| <b>description</b> | refrigeration gasket profile 9797 W 365mm L 560mm plug size |                 |                        |

**For models:**

CMFN-102-R, CMFN-135, CMFN-147-R, CMFN-180, CMFN-192-R, CMFN-225, CMFN-237-R, CMFN-270, CMFP-102-R, CMFP-135, CMFP-135F, CMFP-135-GR, CMFP-135HD, CMFP-135PC, CMFP-147-R, CMFP-180, CMFP-180F, CMFP-180-GR, CMFP-180HDD, CMFP-180HHD, CMFP-180PC, CMFP-192-R, CMFP-225, CMFP-225F, CMFP-225-GR, CMFP-225HDDD, CMFP-225HHDD, CMFP-225HHHD, CMFP-225PC, CMFP-237-R, CMFP-270, CMMZ-180-7, CMMZ-225-7, CMPZ1-135, CMPZ1-180, MCN-135-GN, MCN-180-GN, MCN-270-GN, MCP-135-GN, MCP-147-GN-R, MCP-180-GN, MCP-192-GN-R, MCP-225-GN, MCP-237-GN-R, MCP-270-GN, MEP-135, MEP-135-GN, MEP-180, MEP-180-GN, MFN-135...(Other models you can see in the webshop)

Зип Общепит

vsezip.ru

+7(812)987-08-81

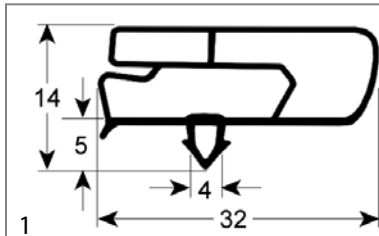

|                    |  |                 |                        |
|--------------------|--|-----------------|------------------------|
| <b>GEV No.</b>     | 902188   | <b>Ref. No.</b> | 12068575<br>6045010158 |
| <b>description</b> | refrigeration gasket profile 9797 W 370mm L 548mm plug size Qty 1  |                 |                        |
| <b>For models:</b> | ADM-CN-135, ADM-CN-180, ADM-CN-225, ADMCP-135, ADMCP-180, ADMCP-225, ADMFN-135, ADMFN-180, ADMFN-225, ADMFP-135, ADMFP-135-GR, ADMFP-135HD, ADMFP-135PC, ADMFP-180, ADMFP-180-GR, ADMFP-180HDD, ADMFP-180HHD, ADMFP-180PC, ADMFP-225, ADMFP-225-GR, ADMFP-225HDD, ADMFP-225HHD, ADMFP-225HHHD, ADMFP-225PC, MCP-135-AD, MCP-180-AD, MCP-225-AD, MFP-135-AD, MFP-135-AD-2C, MFP-135-AD-PC, MFP-180-AD, MFP-180-AD-2C, MFP-180-AD-4C, MFP-180-AD-PC, MFP-225-AD, MFP-225-AD-2C, MFP-225-AD-4C, MFP-225-AD-6C, MFP-225-AD-PC, MFPG-135-AD, MFPG-180-AD, MFPG-225-AD |                 |                        |

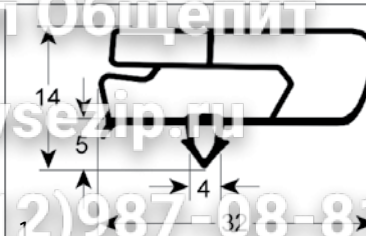

|                    |   |                 |                        |
|--------------------|---|-----------------|------------------------|
| <b>GEV No.</b>     | 901754  | <b>Ref. No.</b> | 12035142<br>6045010124 |
| <b>description</b> | refrigeration gasket profile 9797 W 440mm L 755mm plug size   |                 |                        |
| <b>For models:</b> | CFMP-117-R, CFMP-117-RPC, CFMP-150, CFMP-150F, CFMP-150PC, CFMP-150TV, CFMP-169-R, CFMP-169-RPC, CFMP-202, CFMP-202F, CFMP-202PC, CFMP-202TV, CFMP-222-R, CFMP-222-RPC, CFMP-255, CFMP-255F, CFMP-255PC, CFMP-255TV, CFMP-307, CFMP-307F, CFMP-307TV, FMP-117-R, FMP-150, FMP-150-TV, FMP-169-R, FMP-200, FMP-202, FMP-202-TV, FMP-222-R, FMP-250, FMP-255, FMP-255-TV, FMP-274-R, FMP-300, FMP-307, FMP-307-TV |                 |                        |

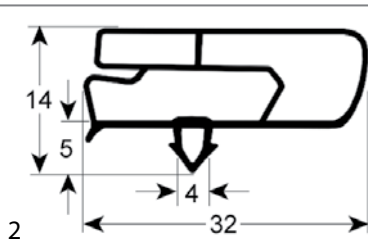

|                    |   |                 |          |
|--------------------|---|-----------------|----------|
| <b>GEV No.</b>     | 900904  | <b>Ref. No.</b> | 12034291 |
| <b>description</b> | refrigeration gasket profile 9797 W 380mm L 585mm plug size |                 |          |

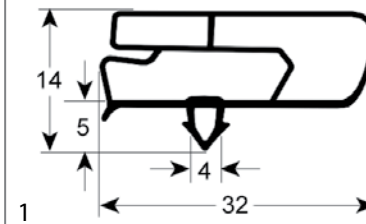

|                    |  |                 |                        |
|--------------------|--|-----------------|------------------------|
| <b>GEV No.</b>     | 901751   | <b>Ref. No.</b> | 12035824<br>6045010118 |
| <b>description</b> | refrigeration gasket profile 9797 W 445mm L 246mm plug size  |                 |                        |
| <b>For models:</b> | CMSP-150HD, CMSP-150HH, CMSP-200HDD, CMSP-200HHD, CMSP-200HHH, CMSP-250HDD, CMSP-250HHD, CMSP-250HHH, CMSP-250HHH, MSP-117-2RC, MSP-117-4RC, MSP-117-R2C, MSP-117-R4C, MSP-150-2C, MSP-150-4C, MSP-169-R2C, MSP-169-R4C, MSP-169-R6C, MSP-200-2C, MSP-200-4C, MSP-200-6C, MSP-222-R2C, MSP-222-R4C, MSP-222-R6C, MSP-222-R8C, MSP-250-2C, MSP-250-4C, MSP-250-6C, MSP-250-8C, MSP-274-R10C, MSP-274-R6C, MSP-300-10C, MSP-300-2C, MSP-300-4C, MSP-300-8C |                 |                        |

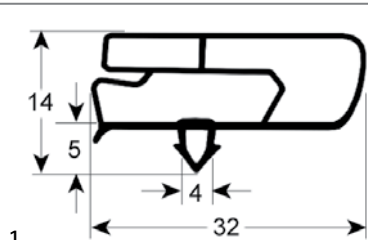

|                    |  |                 |                        |
|--------------------|--|-----------------|------------------------|
| <b>GEV No.</b>     | 901530   | <b>Ref. No.</b> | 12035412<br>6045010115 |
| <b>description</b> | refrigeration gasket profile 9797 W 440mm L 560mm plug size  |                 |                        |
| <b>For models:</b> | CMMZ-150, CMMZ-202, CMPN-117-R, CMPN-150, CMPN-169-R, CMPN-202, CMPN-222-R, CMPN-255, CMPP-117-R, CMPP-150, CMPP-150-C, CMPP-169-R, CMPP-202, CMPP-202-C, CMPP-222-R, CMPP-255, CMPP-255-C, CMPP-307, CMSN-117-R, CMSN-150, CMSN-169-R, CMSN-200, CMSN-222-R, CMSN-250, CMSN-300, CMSP-117-R, CMSP-150, CMSP-150F, CMSP-150HD, CMSP-150PC, CMSP-169-R, CMSP-200, CMSP-200F, CMSP-200HDD, CMSP-200HHD, CMSP-200PC, CMSP-222-R, CMSP-250, CMSP-250F, CMSP-250HDD, CMSP-250HHD, CMSP-250HHHD, CMSP-250PC, CMSP-274-R, CMSP-300, CMSP-300F, MMZ-150, MMZ-202, MPN-117-R, MPN-150...(Other models you can see in the webshop) |                 |                        |

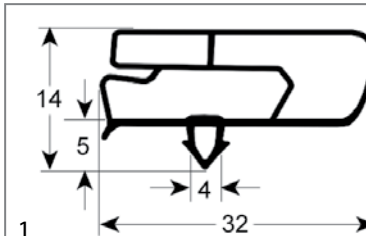

|                    |   |                 |                        |
|--------------------|---|-----------------|------------------------|
| <b>GEV No.</b>     | 901753  | <b>Ref. No.</b> | 12047040<br>6045010154 |
| <b>description</b> | refrigeration gasket profile 9797 W 565mm L 440mm plug size |                 |                        |
| <b>For models:</b> | ATM-051ECO, ATM-051VCH, ATM-051VCH-60Hz                     |                 |                        |



Зип Общепит

vsezip.ru

+7(812)987-08-81

|                    |   |                 |  |
|--------------------|---|-----------------|--|
| <b>GEV No.</b>     | 900905  | <b>Ref. No.</b> | 12032337<br>12033379<br>12034384<br>12034419<br>6001401109<br>6045010014<br>6045010026<br>6045010030 |
| <b>description</b> | refrigeration gasket profile 9797 W 610mm L 1500mm plug size L1 1520mm W1 630mm external size   |                 |  |
| <b>For models:</b> | AEP-1402, AEP-1602, AEP-2103, AEP-701, AEP-801, AF-1402-MIX, AF-1403-C, AF-1403-P, AF-1404-C, AF-1404-P, AF-1602-MIX, AF-1603-C, AF-1603-P, AF-1604-C, AF-1604-P, AF-2104-C, AF-2104-P, AF-2105-C, AF-2105-P, AF-2106-C, AF-2106-P, AFN-1402, AFN-1403, AFN-1602, AFN-1603, AFN-701, AFN-801, AFP-1402, AFP-1402-FORZ, AFP-1402-MIX, AFP-1403, AFP-1403-C, AFP-1403-FORZ, AFP-1403-P, AFP-1602, AFP-1602-2, AFP-1603, AFP-1603-2, AFP-2103, AFP-2104, AFP-2104-C, AFP-2104-P, AFP-2105, AFP-2105-C, AFP-2105-P, AFP-701, AFP-801, AP-701, APP-701 |                 |  |

|                    |   |                 |                        |
|--------------------|---|-----------------|------------------------|
| <b>GEV No.</b>     | 901760  | <b>Ref. No.</b> | 12034676<br>6045010054 |
| <b>description</b> | refrigeration gasket profile 9797 W 805mm L 460mm plug size |                 |                        |

profile 9333

We offer custom-made gaskets for this profile

|                    |  |                 |     |
|--------------------|--|-----------------|-----|
| <b>GEV No.</b>     | 902167   | <b>Ref. No.</b> | N/A |
| <b>description</b> | refrigeration gasket profile 9333 Wmm L 2500mm |                 |     |

|                    |  |                 |  |
|--------------------|--|-----------------|--|
| <b>GEV No.</b>     | 901601   | <b>Ref. No.</b> | 12038144<br>12092626<br>2021700092<br>6045010132 |
| <b>description</b> | refrigeration gasket profile 9797 W 615mm L 670mm plug size  |                 |  |
| <b>For models:</b> | AEP-1602, AEP-802, AF-1403-C, AF-1403-P, AF-1404-C, AF-1404-P, AF-1603-C, AF-1603-P, AF-1604-C, AF-1604-P, AF-2104-C, AF-2104-P, AF-2105-C, AF-2105-P, AF-2106-C, AF-2106-P, AF-702-C, AF-702-P, AF-802-C, AF-802-P, AFN-1403, AFN-1404, AFN-1602, AFN-1603, AFN-1604, AFN-702, AFN-802, AFP-1403, AFP-1404, AFP-1602, AFP-1603, AFP-1603-2, AFP-1604, AFP-2104, AFP-2105, AFP-2106, AFP-702, AFP-802, AFP-802-2, AFP-802-2C, AFP-802-3C, CAEP-802, CAF-1403C, CAF-1403P, CAF-1404C, CAF-1404P, CAF-1603-C, CAF-1603-P, CAF-1604-C, CAF-1604-P...(Other models you can see in the webshop) |                 |  |

profile 9373

We offer custom-made gaskets for this profile

|                    |  |                 |     |
|--------------------|--|-----------------|-----|
| <b>GEV No.</b>     | 902163   | <b>Ref. No.</b> | N/A |
| <b>description</b> | refrigeration gasket profile 9373 Wmm L 2500mm plug size |                 |     |

screw-in gaskets

profile 9106

We offer custom-made gaskets for this profile

|                    |   |                 |  |
|--------------------|---|-----------------|--|
| <b>GEV No.</b>     | 901802  | <b>Ref. No.</b> | 12033677<br>12034720<br>6001401001<br>6045010001 |
| <b>description</b> | refrigeration gasket profile 9797 W 720mm L 620mm plug size |                 |  |
| <b>For models:</b> | AEP-1403, AEP-1404, AEP-1603, AEP-1604, AEP-702, AEP-802    |                 |  |

|                    |  |                 |     |
|--------------------|--|-----------------|-----|
| <b>GEV No.</b>     | 902262   | <b>Ref. No.</b> | N/A |
| <b>description</b> | refrigeration gasket profile 9106 Wmm L 2500mm |                 |     |

Зип Общепит



+7(812)987-08-81

profile 9170

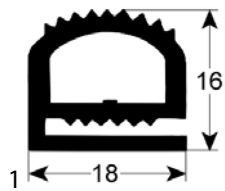

|                    |  |                 |                        |
|--------------------|--|-----------------|------------------------|
| <b>GEV No.</b>     | 901293   | <b>Ref. No.</b> | 12030627<br>6045050004 |
| <b>description</b> | refrigeration gasket profile 9170 W 605mm L 1295mm external size |                 |                        |

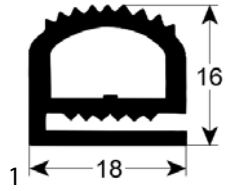

|                    |  |                 |                        |
|--------------------|--|-----------------|------------------------|
| <b>GEV No.</b>     | 902139   | <b>Ref. No.</b> | 12029402<br>6045050008 |
| <b>description</b> | refrigeration gasket profile 9170 W 630mm L 1233mm external size |                 |                        |
| <b>For models:</b> | CCF-20, CCF-20CI, CCF-40, CCF-40CI                               |                 |                        |

gaskets for heated units

window seals



|                    |               |                 |                     |
|--------------------|---------------|-----------------|---------------------|
| <b>GEV No.</b>     | 691056        | <b>Ref. No.</b> | 12039758<br>3712700 |
| <b>description</b> | window gasket |                 |                     |

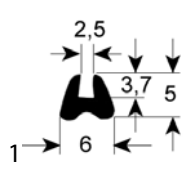

|                    |  |                 |                     |
|--------------------|--|-----------------|---------------------|
| <b>GEV No.</b>     | 691068   | <b>Ref. No.</b> | 11000170<br>3713800 |
| <b>description</b> | window gasket profile 1505 L 1300mm suitable for FAGOR Qty 1 |                 |                     |
| <b>For models:</b> | HCG-20-11, HMG-20-11   |                 |                     |

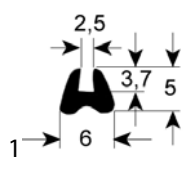

|                    |  |                 |         |
|--------------------|--|-----------------|---------|
| <b>GEV No.</b>     | 691041   | <b>Ref. No.</b> | R660501 |
| <b>description</b> | window gasket profile 1505 L 1700mm suitable for FAGOR Qty 1 |                 |         |

|                    |  |                 |         |
|--------------------|--|-----------------|---------|
| <b>GEV No.</b>     | 691042   | <b>Ref. No.</b> | R670528 |
| <b>description</b> | window gasket profile 1505 L 2800mm suitable for FAGOR Qty 1 |                 |         |

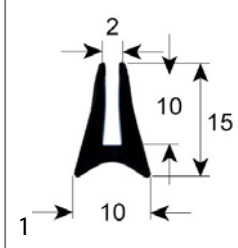

|                    |  |                 |                     |
|--------------------|--|-----------------|---------------------|
| <b>GEV No.</b>     | 900835   | <b>Ref. No.</b> | 11000086<br>3715200 |
| <b>description</b> | window gasket profile 1605 Qty supplied by meter |                 |                     |

**For models:** COE-061, COE-101, COE-102, COE-201, COE-202, COG-061, COG-101, COG-102, COG-201, COG-202, HCG-10-11, HCG-10-21, HCG-20-11, HCG-20-21, HCG-2-10-11, HCG-2-20-11, HCG-6-11, HEI-10-11, HEI-10-21, HEI-20-11, HEI-20-21, HEI-6-11, HEM-10-11, HEM-10-21, HEM-20-11, HEM-20-21, HEM-6-11, HEP-10-11, HEP-10-21, HEP-20-11, HEP-20-21, HEP-6-11, HGC-10-11, HGC-10-21, HGC-20-11, HGC-20-21, HGC-6-11, HGP-10-21, HGP-20-21, HGV-10-11, HGV-10-21, HGV-20-11, HGV-20-21, HME-10-11, HME-10-21, HME-20-11, HME-20-21, HME-2-10-11, HME-2-20-11, HME-6-11...(Other models you can see in the webshop)

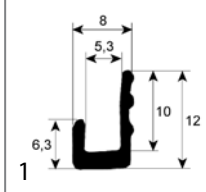

|                    |   |                 |                     |
|--------------------|---|-----------------|---------------------|
| <b>GEV No.</b>     | 691038                                    | <b>Ref. No.</b> | 11000173<br>R660500 |
| <b>description</b> | window gasket profile 1905 L 2500mm Qty 1 |                 |                     |

**For models:** HCG-6-11, HME-6-11, HMG-6-11, HMI-6-11, HMI-6-11UL, HMM-6-11, HMM-6-11UL, HMP-6-11



|                    |  |                 |         |
|--------------------|--|-----------------|---------|
| <b>GEV No.</b>     | 691096   | <b>Ref. No.</b> | R670529 |
| <b>description</b> | window gasket profile 1905 L 3000mm suitable for FAGOR Qty 1 mounting pos. inner |                 |         |



|                    |   |                 |         |
|--------------------|---|-----------------|---------|
| <b>GEV No.</b>     | 691040                                    | <b>Ref. No.</b> | R680515 |
| <b>description</b> | window gasket profile 1905 L 4000mm Qty 1 |                 |         |



Зип Общепит

vsezip.ru

+7(812)987-08-81

|                    |  |                 |         |
|--------------------|--|-----------------|---------|
| 1                  |  |                 |         |
| <b>GEV No.</b>     | 691061   | <b>Ref. No.</b> | R090515 |
| <b>description</b> | window gasket profile 1905 L 4100mm suitable for FAGOR Qty 1 mounting pos. inner |                 |         |

|                    |  |                     |         |
|--------------------|--|---------------------|---------|
| 1                  |  | Image not available |         |
| <b>GEV No.</b>     | 691063   | <b>Ref. No.</b>     | R140508 |
| <b>description</b> | window gasket profile 1905 L 4600mm suitable for FAGOR Qty 1 mounting pos. inner |                     |         |

|                    |   |                 |                  |
|--------------------|---|-----------------|------------------|
| 1                  |   |                 |                  |
| <b>GEV No.</b>     | 691055  | <b>Ref. No.</b> | 12007972 R090510 |
| <b>description</b> | door seal profile 2270 W 650mm L 1300mm external size Qty 1   |                 |                  |
| <b>For models:</b> | COE-201, COG-201, HCG-20-11, HEI-20-11, HEM-20-11, HEP-20-11, HGC-20-11, HGV-20-11, HME-20-11, HMG-20-11, HMM-20-11, HMM-20-11UL, HMP-20-11, HVG-20-11, MFHMM-20-11, VE-201, VG-201, VPE-201, VPG-201 |                 |                  |

door seals

|                    |  |                 |                  |
|--------------------|--|-----------------|------------------|
| 1                  |  |                 |                  |
| <b>GEV No.</b>     | 901706   | <b>Ref. No.</b> | 12024276 T490500 |
| <b>description</b> | door seal profile 2048 W 675mm L 1450mm external size  |                 |                  |
| <b>For models:</b> | COE-202, COG-202, HEI-20-21, HEM-20-21, HEP-20-21, HGC-20-21, HGP-20-21, HGV-20-21, VE-202, VG-202, VPE-202, VPG-202 |                 |                  |

|                    |  |                 |                  |
|--------------------|--|-----------------|------------------|
| 1                  |  |                 |                  |
| <b>GEV No.</b>     | 691036   | <b>Ref. No.</b> | 12024186 R670500 |
| <b>description</b> | door seal profile 2270 W 650mm L 705mm external size Qty 1   |                 |                  |
| <b>For models:</b> | COE-101, COG-101, HCG-10-11, HEI-10-11, HEM-10-11, HEP-10-11, HGC-10-11, HGV-10-11, HME-10-11, HMG-10-11, HMG-10-11UL, HMI-10-11, HMI-10-11UL, HMM-10-11, HMM-10-11UL, HMP-10-11, HVG-10-11, HVG-10-11UL, HVG-2-10-11, MFHVG-10-11, VE-101, VG-101, VPE-101, VPG-101 |                 |                  |

|                    |  |                 |                  |
|--------------------|--|-----------------|------------------|
| 1                  |  |                 |                  |
| <b>GEV No.</b>     | 901707   | <b>Ref. No.</b> | 12023944 T300500 |
| <b>description</b> | door seal profile 2048 W 675mm L 775mm external size   |                 |                  |
| <b>For models:</b> | COE-102, COG-102, HEI-10-21, HEM-10-21, HEP-10-21, HGC-10-21, HGP-10-21, HGV-10-21, VE-102, VG-102, VPE-102, VPG-102 |                 |                  |

|                    |   |                 |                  |
|--------------------|---|-----------------|------------------|
| 1                  |   |                 |                  |
| <b>GEV No.</b>     | 691062  | <b>Ref. No.</b> | 12017241 R140506 |
| <b>description</b> | door seal profile 2270 W 775mm L 1300mm external size Qty 1   |                 |                  |
| <b>For models:</b> | HCG-20-21, HCG-2-20-11, HME-20-21, HME-2-20-11, HMM-20-21, HMM-20-21UL, HMM-2-20-11, HMM-40-11-USMC, HMP-20-21, HMP-2-20-11, HVG-20-21, HVG-2-20-21 |                 |                  |

|                    |   |                 |                  |
|--------------------|---|-----------------|------------------|
| 1                  |   |                 |                  |
| <b>GEV No.</b>     | 691035  | <b>Ref. No.</b> | 12024187 R660503 |
| <b>description</b> | door seal profile 2270 W 465mm L 650mm external size Qty 1  |                 |                  |
| <b>For models:</b> | COE-061, COG-061, HCG-6-11, HEI-6-11, HEM-6-11, HEP-6-11, HGC-6-11, HME-6-11, HMG-6-11, HMI-6-11, HMI-6-11UL, HMM-6-11, HMM-6-11UL, HMP-6-11, VE-061, VPE-061 |                 |                  |

|                    |   |                 |                  |
|--------------------|---|-----------------|------------------|
| 1                  |   |                 |                  |
| <b>GEV No.</b>     | 691069  | <b>Ref. No.</b> | 12017439 R680500 |
| <b>description</b> | door seal profile 2270 W 775mm L 705mm external size Qty 1  |                 |                  |
| <b>For models:</b> | HCG-10-11, HCG-10-21, HCG-2-10-11, HME-10-21, HME-2-10-11, HMG-10-11, HMG-10-21, HMG-10-21UL, HMG-2-10-11, HMI-10-21, HMI-10-21UL, HMI-2-10-11, HMM-10-21, HMM-10-21UL, HMM-2-10-11, HMP-10-21, HMP-2-10-11, HVG-10-21, HVG-10-21UL, MFH-VG-10-21 |                 |                  |

Зип Общепит

vsezip.ru

+7(812)987-08-81

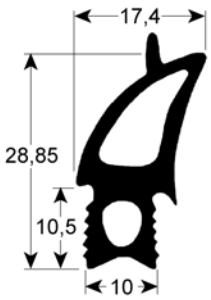

|                    |  |                 |                        |
|--------------------|--|-----------------|------------------------|
| <b>GEV No.</b>     | 902219   | <b>Ref. No.</b> | 12028909<br>RT51051020 |
| <b>description</b> | door seal profile 2730 W 465mm L 520mm external size Qty 1 |                 |                        |

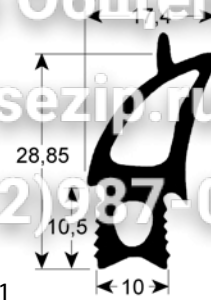

|                    |   |                 |                        |
|--------------------|---|-----------------|------------------------|
| <b>GEV No.</b>     | 902248  | <b>Ref. No.</b> | 12038090<br>RT2000399P |
| <b>description</b> | door seal profile 2730 W 675mm L 1475mm suitable for RATIONAL for model SCC/CM202 outer plug size |                 |                        |

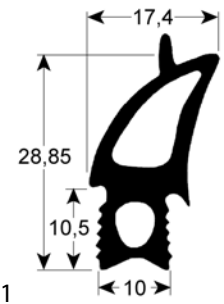

|                    |   |                 |                        |
|--------------------|---|-----------------|------------------------|
| <b>GEV No.</b>     | 902246  | <b>Ref. No.</b> | 12028517<br>RT2000398P |
| <b>description</b> | door seal profile 2730 W 470mm L 1475mm suitable for RATIONAL for model SCC/CM201 outer plug size Qty 1 |                 |                        |

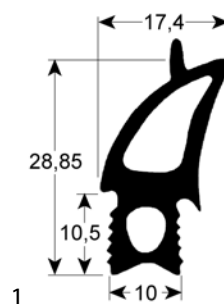

|                    |  |                 |          |
|--------------------|--|-----------------|----------|
| <b>GEV No.</b>     | 902197   | <b>Ref. No.</b> | 12041578 |
| <b>description</b> | door seal profile 2730 W 675mm L 775mm   |                 |          |
| <b>For models:</b> | ACE-102, ACG-102, AE-102, AE-102W, AG-102, AG-102W, APE-102, APE-102W, APG-102, APG-102W |                 |          |

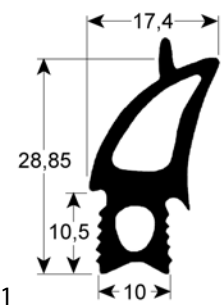

|                    |  |                 |   |
|--------------------|--|-----------------|---|
| <b>GEV No.</b>     | 902221   | <b>Ref. No.</b> | 12029172<br>12029261<br>RT2000394<br>RT2000394P |
| <b>description</b> | door seal profile 2730 W 470mm L 500mm suitable for RATIONAL for model SCC/CM 61 outer plug size Qty 1 |                 |   |

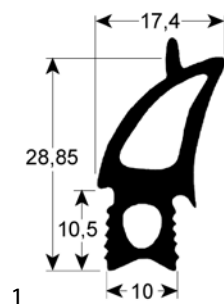

|                    |  |                 |            |
|--------------------|--|-----------------|------------|
| <b>GEV No.</b>     | 900292   | <b>Ref. No.</b> | RT51051022 |
| <b>description</b> | door seal profile 2730 W 685mm L 780mm outer plug size |                 |            |

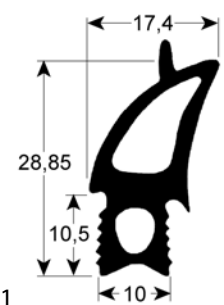

|                    |  |                 |                        |
|--------------------|--|-----------------|------------------------|
| <b>GEV No.</b>     | 902247   | <b>Ref. No.</b> | 12028537<br>RT51051021 |
| <b>description</b> | door seal profile 2730 W 470mm L 785mm suitable for RATIONAL for model CPC 101 outer plug size Qty 1 |                 |                        |

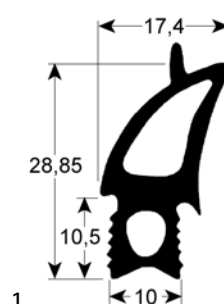

|                    |  |                 |                         |
|--------------------|--|-----------------|-------------------------|
| <b>GEV No.</b>     | 902220   | <b>Ref. No.</b> | 12028287<br>RT51051022P |
| <b>description</b> | door seal profile 2730 W 685mm L 780mm suitable for RATIONAL for model SCC/CM102 edition since 11/2011 outer plug size |                 |                         |

Зип Общепит

vsezip.ru

+7(812)987-08-81



|                    |   |                 |   |
|--------------------|---|-----------------|---|
| <b>GEV No.</b>     | 902222  | <b>Ref. No.</b> | 12028152<br>12028843<br>RT2000396<br>RT2000396P |
| <b>description</b> | door seal profile 2731 W 470mm L 760mm suitable for RATIONAL for model SCC/CM 101 edition since 05/2011 outer plug size |                 |   |

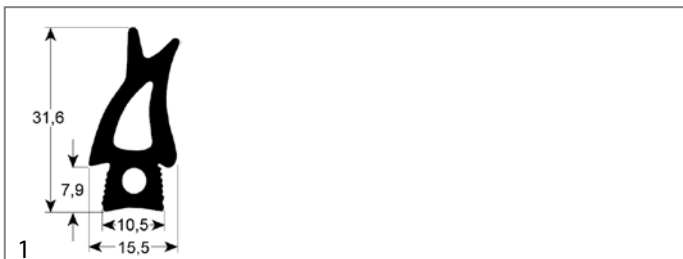

|                    |   |                 |                        |
|--------------------|---|-----------------|------------------------|
| <b>GEV No.</b>     | 902480  | <b>Ref. No.</b> | 12039475<br>T800550000 |
| <b>description</b> | door seal profile 2732 W 460mm L 770mm outer plug size for combi-steamer suitable for FAGOR |                 |                        |
| <b>For models:</b> | ACE-101, ACG-101, AE-101, AE-101W, AG-101, AG-101W, APE-101, APE-101W, APG-101, APG-101W    |                 |                        |

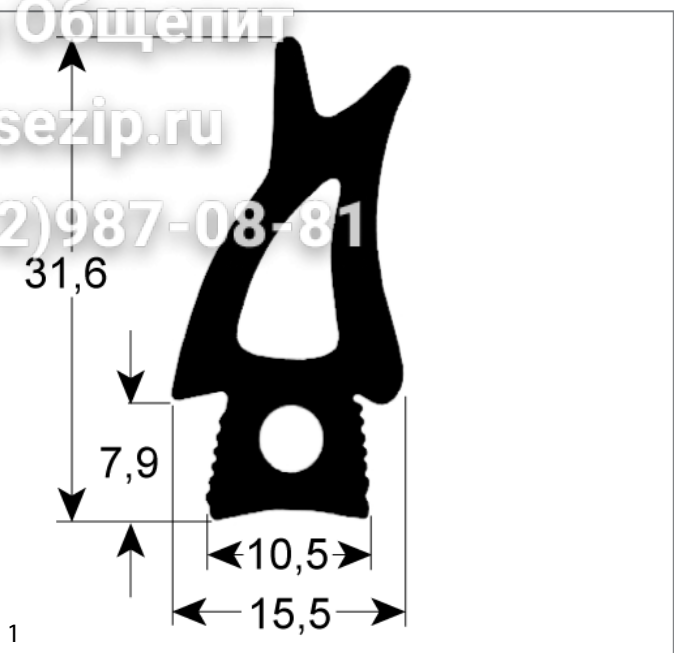

|                    |   |                 |                        |
|--------------------|---|-----------------|------------------------|
| <b>GEV No.</b>     | 902554  | <b>Ref. No.</b> | 12039599<br>T910550000 |
| <b>description</b> | door seal profile 2732 W 470mm L 500mm Qty 1 for model outer plug size suitable for FAGOR |                 |                        |
| <b>For models:</b> | ACE-061, ACG-061, AE-061, AE-061W, AG-061, AG-061W, APE-061, APE-061W, APG-061, APG-061W  |                 |                        |

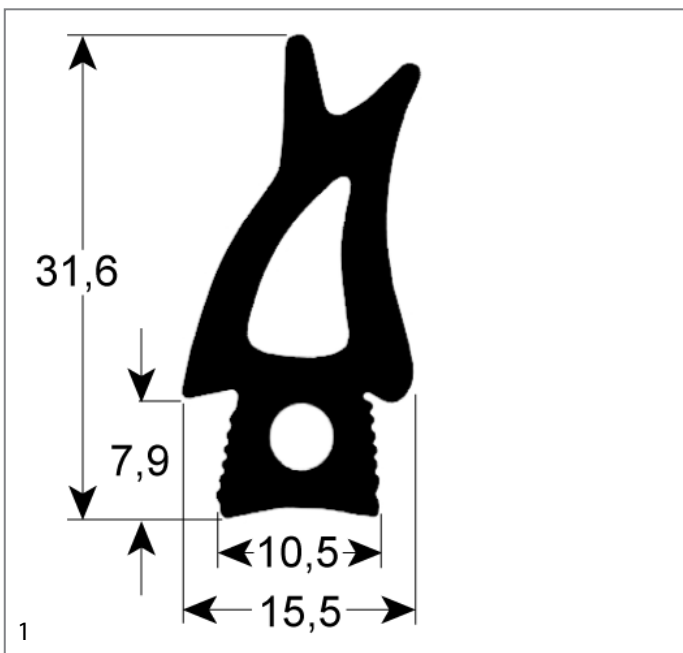

|                    |  |                 |                        |
|--------------------|--|-----------------|------------------------|
| <b>GEV No.</b>     | 902555   | <b>Ref. No.</b> | 12041134<br>T740563000 |
| <b>description</b> | door seal profile 2732 W 470mm L 1150mm outer plug size Qty 1 suitable for FAGOR |                 |                        |
| <b>For models:</b> | ACE-201, ACG-201, AE-201, AG-201, APE-201, APG-201                               |                 |                        |



|                    |   |                 |                        |
|--------------------|---|-----------------|------------------------|
| <b>GEV No.</b>     | 902223  | <b>Ref. No.</b> | 12027994<br>RT51051023 |
| <b>description</b> | door seal profile 2732 W 485mm L 1495mm external size Qty 1 |                 |                        |

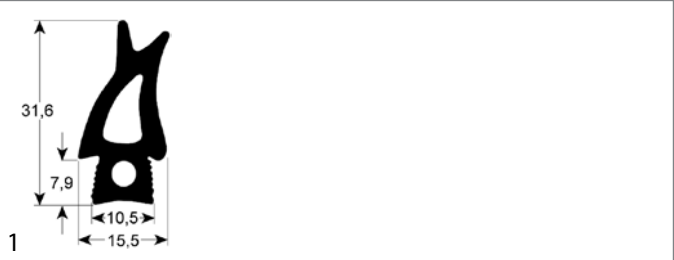

|                    |   |                 |                        |
|--------------------|---|-----------------|------------------------|
| <b>GEV No.</b>     | 902250  | <b>Ref. No.</b> | 12027846<br>RT51051024 |
| <b>description</b> | door seal profile 2732 W 680mm L 1495mm suitable for RATIONAL for model CPC 202 outer plug size |                 |                        |

Зип Общепит

vsezip.ru

+7(812)987-08-81

|                    |  |                 |                        |
|--------------------|--|-----------------|------------------------|
| <b>GEV No.</b>     | 902249   | <b>Ref. No.</b> | 12029014<br>RT2000397P |
| <b>description</b> | door seal profile 2733 W 675mm L 760mm suitable for RATIONAL for model SCC/CM102 edition since 05/2011 outer plug size |                 |                        |

|                    |  |                 |          |
|--------------------|--|-----------------|----------|
| <b>GEV No.</b>     | 902060                                 | <b>Ref. No.</b> | 12009413 |
| <b>description</b> | door seal W 10mm L 1650mm Qty 1        |                 |          |
| <b>For models:</b> | CGB7-61, CGB7-61H, CGB7-61R, CGB7-61RH |                 |          |

door seals with fixing hook

|                    |  |                 |                     |
|--------------------|--|-----------------|---------------------|
| <b>GEV No.</b>     | 691027   | <b>Ref. No.</b> | 12020663<br>U745626 |
| <b>description</b> | door seal W 500mm long side open with 4 mounting clips H 290mm   |                 |                     |
| <b>For models:</b> | CE7-41, CE9-41, CG-1002, CG-1502, CG-2002, CG-210, CG-210G, CG-310, CG-310G, CG7-11, CG7-41, CG7-61, CG9-11, CG9-41, CG9-51L, CG9-51LC, CG9-51R, CG9-51RC, CG9-61, CG9-82, CGE7-160, CGE7-41, CGE9-41, FTG9-11L, FTG9-11L+R, FTG9-11R, FTGC9-11L, FTGC9-11L+R, FTGC9-11R, HE9-10, HE9-20, HG9-10, HG9-20 |                 |                     |

|                    |   |                 |          |
|--------------------|---|-----------------|----------|
| <b>GEV No.</b>     | 901705  | <b>Ref. No.</b> | 12008213 |
| <b>description</b> | door seal W 520mm with 4 mounting clips H 300mm   |                 |          |
| <b>For models:</b> | CE7-41, CE9-41, CG-1002, CG-1502, CG-2002, CG-2002P, CG-210, CG-210G, CG-310, CG-310G, CG7-11, CG7-31D, CG7-31I, CG7-41, CG7-41H, CG7-51, CG7-61, CG7-61H, CG9-11, CG9-41, CG9-41H, CG9-51L, CG9-51LC, CG9-51R, CG9-51RC, CG9-61, CG9-61H, CG9-82, CGE7-41, CGE7-41H, CGE9-11, CGE9-41, CGF9-121D, CGF9-121I, FTG9-11L, FTG9-11L+R, FTG9-11R, FTGC9-11L, FTGC9-11L+R, FTGC9-11R, HE9-10, HE9-20, HG9-10, HG9-20 |                 |          |

|                    |  |                 |                     |
|--------------------|--|-----------------|---------------------|
| <b>GEV No.</b>     | 901429   | <b>Ref. No.</b> | 12009146<br>U105605 |
| <b>description</b> | door seal W 900mm with 6 mounting clips H 340mm long side open |                 |                     |
| <b>For models:</b> | CG9-61OP, CG9-15   |                 |                     |

gaskets for tray rack trolleys

|                    |   |                 |          |
|--------------------|---|-----------------|----------|
| <b>GEV No.</b>     | 902440  | <b>Ref. No.</b> | 12007990 |
| <b>description</b> | tray rack trolley gasket L 705mm suitable for FAGOR Qty 1 |                 |          |

|                    |   |                 |                        |
|--------------------|---|-----------------|------------------------|
| <b>GEV No.</b>     | 902229  | <b>Ref. No.</b> | 12031433<br>RT51051025 |
| <b>description</b> | tray rack trolley gasket profile 4090 L 615mm Qty 1 |                 |                        |

|                    |   |                 |                        |
|--------------------|---|-----------------|------------------------|
| <b>GEV No.</b>     | 902230  | <b>Ref. No.</b> | 12030369<br>RT51051026 |
| <b>description</b> | tray rack trolley gasket profile 4090 L 820mm Qty 1 |                 |                        |

|                    |   |                 |                       |
|--------------------|---|-----------------|-----------------------|
| <b>GEV No.</b>     | 902231  | <b>Ref. No.</b> | 12031375<br>RT2400187 |
| <b>description</b> | tray rack trolley gasket profile 4095 L 575mm Qty 1 |                 |                       |



Зип Общепит

vsezip.ru

+7(812)987-08-81

|                    |   |                 |                       |
|--------------------|---|-----------------|-----------------------|
| <b>GEV No.</b>     | 902232  | <b>Ref. No.</b> | 12028867<br>RT2400194 |
| <b>description</b> | tray rack trolley gasket profile 4095 L 780mm Qty 1 |                 |                       |

|                    |   |                 |          |
|--------------------|---|-----------------|----------|
| <b>GEV No.</b>     | 900908  | <b>Ref. No.</b> | 12009435 |
| <b>description</b> | lid gasket ED ø 65mm  |                 |          |
| <b>For models:</b> | MPE9-10BM, MPE9-10BMS, MPE9-15BM, MPE9-15BMS, MPG9-10, MPG9-10BM, MPG9-10BMS, MPG9-10S, MPG9-15, MPG9-15BM, MPG9-15BMS, MPG9-15S, MPG9-20, MPG9-20S |                 |          |

|                    |  |                 |                        |
|--------------------|--|-----------------|------------------------|
| <b>GEV No.</b>     | 902553   | <b>Ref. No.</b> | 12041088<br>T740562000 |
| <b>description</b> | tray rack trolley gasket profile 4160 L 510mm suitable for FAGOR Qty 1 |                 |                        |
| <b>For models:</b> | ACE-201, ACG-201, AE-201, AG-201, APE-201, APG-201                     |                 |                        |

O-rings

EPDM

|                    |  |                 |                     |
|--------------------|--|-----------------|---------------------|
| <b>GEV No.</b>     | 529545   | <b>Ref. No.</b> | 12009911<br>Q307056 |
| <b>description</b> | O-ring EPDM thickness 1.78mm ID ø 10.82mm Qty 1 pcs  |                 |                     |
| <b>For models:</b> | AD-15, AD-15D, AD-20C-UK, AD-21, AD-21B, AD-21BDD, AD-21C, AD-21D, AD-21DD, AD-21W, CO-350, CO-350-B, CO-350-B-DD, CO-350-COLD, CO-350-COLD-B, CO-350-COLD-B-DD, CO-350-COLD-DD, CO-350-DD, CO-352-COLD, CO-352-COLD-B, CO-352-COLD-B-DD, CO-352-COLD-DD, CO-400, CO-400-B, CO-400-B-DD, CO-400-COLD, CO-400-COLD-B, CO-400-COLD-B-DD, CO-400-COLD-DD, CO-400-DD, CO-400-SOFT, CO-402-COLD, CO-402-COLD-B, CO-402-COLD-B-DD, CO-402-COLD-DD, CO-402W, LVC-12, LVC-15, LVC-15D, LVC-21, LVC-21B, LVC-21C, LVC-21D, LVC-21W, MF-21 |                 |                     |

gaskets for control panels

|                    |                          |                 |                       |
|--------------------|--------------------------|-----------------|-----------------------|
| <b>GEV No.</b>     | 900575                   | <b>Ref. No.</b> | 12032981<br>RT1600387 |
| <b>description</b> | gasket for control panel |                 |                       |

|                    |  |                 |                     |
|--------------------|--|-----------------|---------------------|
| <b>GEV No.</b>     | 505045   | <b>Ref. No.</b> | 12009912<br>Q307036 |
| <b>description</b> | O-ring EPDM thickness 1.78mm ID ø 5.28mm Qty 1 pcs   |                 |                     |
| <b>For models:</b> | AD-15, AD-15D, AD-90, AD-90BA, AD-90BDD, AD-90DD, COG-202, EASY-500, EASY-500B, EASY-500DD, EASY-500HP, EASY-500HPWBDD, FI-30, FI-30AR, FI-30AR+DD, FI-30B, FI-30B-BT-UK, FI-30-UK, FI-48, FI-48AR, FI-48B, FI-48B-BT-UK, FI-48C, FI-48D, FI-48HY-CLINIC, FI-48W, FI-60DD, FI-80, FI-80AR, FI-80W, FI-E-100, HGC-20-21, HGP-10-21, HGP-20-21, HGV-20-21, LABP-800, LF-13MPP, LF-18MPP, LF-25MPP, LF-8MPP, LVC-12, LVC-15, LVC-15D, LVC-21, LVC-21B, LVC-21D, LVC-21W, LVR-10, LVR-14, LVR-20...(Other models you can see in the webshop) |                 |                     |

|                    |   |                 |                        |
|--------------------|---|-----------------|------------------------|
| <b>GEV No.</b>     | 901454  | <b>Ref. No.</b> | 12034523<br>RT51001011 |
| <b>description</b> | gasket for control panel L 2000mm foam rubber self-adhesive |                 |                        |

boiling pan gaskets

|                    |  |                 |                          |
|--------------------|--|-----------------|--------------------------|
| <b>GEV No.</b>     | 900514                                   | <b>Ref. No.</b> | 12026686<br>ICRE30100030 |
| <b>description</b> | boiling pan gasket profile 3020 L 3200mm |                 |                          |

|                    |   |                 |                        |
|--------------------|---|-----------------|------------------------|
| <b>GEV No.</b>     | 532731  | <b>Ref. No.</b> | 12037437<br>RT50120565 |
| <b>description</b> | O-ring EPDM thickness 2.5mm ID ø 115mm Qty 5 pcs suitable for combi-steamer CPC-Linie |                 |                        |

Зип Общепит

vsezip.ru

7(812)987-08-81

|  |   |                 |                     |
|--|---|-----------------|---------------------|
|  |   |                 |                     |
| <b>GEV No.</b>   | 529412  | <b>Ref. No.</b> | 12009873<br>Q307005 |
| <b>description</b>   | O-ring EPDM thickness 2.62mm ID ø 10.78mm Qty 1 pcs   |                 |                     |
| <b>For models:</b>   | AD-120, AD-120B, AD-120BBTDD-UK, AD-120C, AD-120CW, AD-120HY, AD-15, AD-15D, AD-20C-UK, AD-21, AD-21B, AD-21BDD, AD-21C, AD-21D, AD-21DD, AD-21W, AD-45BBT, AD-48, AD-48B, AD-48BDD, AD-48C, AD-48D, AD-48DD, AD-48H, AD-48HY, AD-48W, AD-64, AD-64B, AD-64BBT, AD-64BDD, AD-64BTDD, AD-64C, AD-64CW, AD-64D, AD-64DD, AD-64HY, AD-72, AD-72W, AD-90, AD-90BA, AD-90BBT, AD-90BDD, AD-90DD, ADE-120, ADE-120B, CO-350, CO-350-B, CO-350-B-DD, CO-350-COLD, CO-350-COLD-B, CO-350-COLD-B-DD... (Other models you can see in the webshop) |                 |                     |

|  |  |                 |                                |
|--|--|-----------------|--------------------------------|
|  |  |                 |                                |
| <b>GEV No.</b>   | 522494   | <b>Ref. No.</b> | 12010165<br>Q307051<br>Q307061 |
| <b>description</b>   | O-ring EPDM thickness 2.62mm ID ø 36.14mm Qty 1 pcs  |                 |                                |
| <b>For models:</b>   | AD-120, AD-120B, AD-120BBTDD-UK, AD-120C, AD-120CW, AD-120HY, AD-45BBT, AD-48, AD-48B, AD-48BDD, AD-48C, AD-48D, AD-48DD, AD-48H, AD-48W, AD-64, AD-64B, AD-64BBT, AD-64BDD, AD-64BTDD, AD-64C, AD-64CW, AD-64D, AD-64DD, AD-64HY, AD-72, AD-72W, AD-90, AD-90BA, AD-90BBT, AD-90BDD, AD-90DD, ADE-120, ADE-120B, EASY-500, EASY-500B, EASY-500DD, EASY-500HP, ECO-120, ECO-120B, ECO-160, ECO-160D, ECO-160I, ECO-200, ECO-200D, ECO-200H, ECO-200HD, ECO-200HI, ECO-200I, ECO-2700D... (Other models you can see in the webshop) |                 |                                |

|  |  |                 |                     |
|--|--|-----------------|---------------------|
|  |  |                 |                     |
| <b>GEV No.</b>   | 507313   | <b>Ref. No.</b> | 12009837<br>Q307050 |
| <b>description</b>   | O-ring EPDM thickness 2.62mm ID ø 13.95mm Qty 1 pcs  |                 |                     |
| <b>For models:</b>   | AD-120, AD-120B, AD-120BBTDD-UK, AD-120C, AD-120CW, AD-120HY, AD-45BBT, AD-48, AD-48B, AD-48BDD, AD-48C, AD-48D, AD-48DD, AD-48H, AD-48W, AD-64, AD-64B, AD-64BBT, AD-64BDD, AD-64BTDD, AD-64C, AD-64CW, AD-64D, AD-64DD, AD-64HY, AD-72, AD-72W, AD-90, AD-90BA, AD-90BBT, AD-90BDD, AD-90DD, ADE-120, ADE-120B, BME7-05, BME7-10, BME9-05, BME9-10, BMG7-10, BMG9-05, BMG9-10, EASY-500, EASY-500B, EASY-500DD, EASY-500HP, EASY-500HPWBDD, ECO-120, ECO-120B, FI-100, FI-100AR... (Other models you can see in the webshop) |                 |                     |

|  |  |                 |                     |
|--|--|-----------------|---------------------|
|  |  |                 |                     |
| <b>GEV No.</b>   | 532546   | <b>Ref. No.</b> | 12010184<br>Q307064 |
| <b>description</b>   | O-ring EPDM thickness 2.62mm ID ø 52.07mm Qty 1 pcs  |                 |                     |
| <b>For models:</b>   | ECO-280D, ECO-280I, ECO-370D, ECO-370I, ECO-460D, ECO-460I, ECO-550D, ECO-550I, FI-280D, FI-280I, FI-370D, FI-370I, FI-460D, FI-460I, FI-550D, FI-550I |                 |                     |

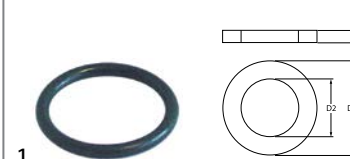
|  |   |                 |                     |
|--|---|-----------------|---------------------|
|  |   |                 |                     |
| <b>GEV No.</b>   | 505073  | <b>Ref. No.</b> | 12010282<br>Q307041 |
| <b>description</b>   | O-ring EPDM thickness 2.62mm ID ø 20.63mm Qty 1 pcs   |                 |                     |
| <b>For models:</b>   | AD-15, AD-15D, AD-20C-UK, AD-21, AD-21B, AD-21BDD, AD-21C, AD-21D, AD-21W, CG-1002, CG-1502, CG-2000, CG-2000-2P, CG-2002, CG-2002P, CG9-11, CG9-11AD, CG9-11PLUS, CG9-31PLUS-D, CG9-31PLUS-I, CG9-41, CG9-41AD, CG9-41AD-H, CG9-41H, CG9-41PLUS, CG9-41PLUS-H, CG9-51L, CG9-51LC, CG9-51R, CG9-51RC, CG9-61, CG9-61AD, CG9-61AD-H, CG9-61H, CG9-61OP, CG9-61PLUS, CG9-61PLUS-H, CG9-82, CG9-82AD, CG9-82PLUS, CGF9-121D, CGF9-121D-AD, CGF9-121I, CGF9-121PLUS-D, CGF9-121PLUS-I, FF-35, FI-5420, FI-7630, FTG9-11L, FTG9-11L+R... (Other models you can see in the webshop) |                 |                     |

|  |   |                 |                     |
|--|---|-----------------|---------------------|
|  |   |                 |                     |
| <b>GEV No.</b>   | 532102  | <b>Ref. No.</b> | 12010234<br>Q307063 |
| <b>description</b>   | O-ring EPDM thickness 3.53mm ID ø 12.29mm Qty 10 pcs  |                 |                     |
| <b>For models:</b>   | ECO-160, ECO-160D, ECO-160I, ECO-200, ECO-200D, ECO-200H, ECO-200HD, ECO-200HI, ECO-200I, ECO-2700D, ECO-2700I, ECO-280D, ECO-280I, ECO-370D, ECO-370I, ECO-4000D, ECO-4000I, ECO-460D, ECO-460I, ECO-550D, ECO-550I, ECO-6000D, ECO-6000I, FI-160, FI-160AR, FI-160D, FI-160I, FI-200, FI-200AR, FI-200D, FI-200H, FI-200HD, FI-200HI, FI-200I, FI-200W, FI-200WL, FI-200WR, FI-2700D, FI-2700I, FI-280D, FI-280I, FI-370D, FI-370I, FI-4000D, FI-4000I, FI-460D, FI-460I, FI-550D, FI-550I, FI-6000D... (Other models you can see in the webshop) |                 |                     |

|  |  |                 |                     |
|--|--|-----------------|---------------------|
|  |  |                 |                     |
| <b>GEV No.</b>   | 532499   | <b>Ref. No.</b> | 12010230<br>Q307062 |
| <b>description</b>   | O-ring EPDM thickness 2.62mm ID ø 23.47mm Qty 1 pcs  |                 |                     |
| <b>For models:</b>   | ECO-160, ECO-160D, ECO-160I, ECO-200, ECO-200D, ECO-200H, ECO-200HD, ECO-200HI, ECO-200I, FI-160, FI-160AR, FI-160D, FI-160I, FI-200, FI-200AR, FI-200D, FI-200H, FI-200HD, FI-200HI, FI-200I, FI-200W, FI-200WL, FI-200WR |                 |                     |

|  |  |                 |                     |
|--|--|-----------------|---------------------|
|  |  |                 |                     |
| <b>GEV No.</b>   | 532151   | <b>Ref. No.</b> | 12021011<br>Z201084 |
| <b>description</b>   | O-ring EPDM thickness 3.53mm ID ø 120.2mm Qty 10 pcs                           |                 |                     |
| <b>For models:</b>   | ECO-120, ECO-120B, FI-100, FI-100AR, FI-100B, FI-120, FI-120B, FI-120W, MF-120 |                 |                     |





Зип Общепит  
vsezip.ru  
47(812)987-08-81

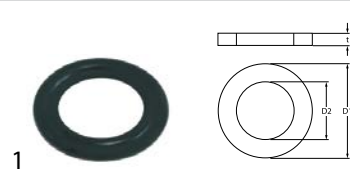

|                    |   |                 |          |
|--------------------|---|-----------------|----------|
| <b>GEV No.</b>     | 532103  | <b>Ref. No.</b> | 12019214 |
| <b>description</b> | O-ring EPDM thickness 3.53mm ID $\varnothing$ 13.87mm Qty 10 pcs  |                 |          |
| <b>For models:</b> | AD-125, AD-125HRS, AD-125-SOFT, CO-110, CO-110B, CO-110BDD, CO-110DD, CO-112, CO-112B, CO-112BDD, CO-112DD, CO-170, CO-170B, CO-170BDD, CO-170DD, CO-170HRS, CO-170HRSDD, CO-170HRS-SOFT, CO-170-SOFT, CO-172, CO-172B, CO-172BDD, CO-172DD, COP-173, COP-173B, COP-173BDD, COP-173DD, COP-173HRS, COP-173HRSDD, COP-173-SOFT, COP-174, COP-174B, COP-174BDD, COP-174DD, COP-174HRS, COP-174HRSDD |                 |          |



|                    |  |                 |                  |
|--------------------|--|-----------------|------------------|
| <b>GEV No.</b>     | 505130   | <b>Ref. No.</b> | 12010118 Q307057 |
| <b>description</b> | O-ring EPDM thickness 3.53mm ID $\varnothing$ 47.22mm Qty 1 pcs  |                 |                  |
| <b>For models:</b> | AD-120, AD-120B, AD-120BBTDD-UK, AD-120C, AD-120CW, AD-120HY, AD-90, AD-90BA, AD-90BBT, AD-90BDD, AD-90DD, ADE-120, ADE-120B, ECO-120, ECO-120B, ECO-160, ECO-160D, ECO-160I, ECO-200, ECO-200D, ECO-200H, ECO-200HD, ECO-200HI, ECO-200I, ECO-280D, ECO-280I, ECO-370D, ECO-370I, ECO-460D, ECO-460I, ECO-550D, ECO-550I, FI-100, FI-100AR, FI-100B, FI-100BBT-UK, FI-120, FI-120AR+DD, FI-120B, FI-120C, FI-120HY-CLINIC, FI-120W, FI-160, FI-160D, FI-160I, FI-200, FI-200D, FI-200H, FI-200HD, FI-200HI... (Other models you can see in the webshop) |                 |                  |

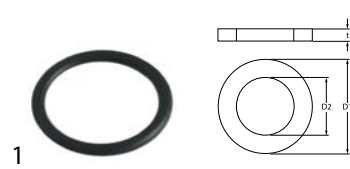

|                    |   |                 |                  |
|--------------------|---|-----------------|------------------|
| <b>GEV No.</b>     | 505152  | <b>Ref. No.</b> | 12009666 Q307000 |
| <b>description</b> | O-ring EPDM thickness 3.53mm ID $\varnothing$ 29mm Qty 1 pcs  |                 |                  |
| <b>For models:</b> | ECO-1200, ECO-1600, ECO-2300, ECO-3000, FE-18, FE-25, FI-1200, FI-1600, FI-2300, FI-3000, FI-300B, FI-300R, FI-650R, FI-900 |                 |                  |



|                    |   |                 |                  |
|--------------------|---|-----------------|------------------|
| <b>GEV No.</b>     | 532498  | <b>Ref. No.</b> | 12010256 Q307048 |
| <b>description</b> | O-ring EPDM thickness 3.53mm ID $\varnothing$ 9.12mm Qty 1 pcs  |                 |                  |
| <b>For models:</b> | AD-120, AD-120B, AD-120BBTDD-UK, AD-120C, AD-120CW, AD-120HY, AD-45BBT, AD-48, AD-48B, AD-48BDD, AD-48C, AD-48D, AD-48DD, AD-48HY, AD-48W, AD-64, AD-64B, AD-64BBT, AD-64BDD, AD-64BTDD, AD-64C, AD-64CW, AD-64D, AD-64DD, AD-64HY, AD-72, AD-72W, AD-90, AD-90BA, AD-90BBT, AD-90BDD, AD-90DD, ADE-120, ADE-120B, EASY-500, EASY-500B, EASY-500DD, EASY-500HP, EASY-500HPWBDD, ECO-120, ECO-1200, ECO-120B, ECO-160, ECO-1600, ECO-160D, ECO-160I, ECO-200, ECO-200D, ECO-200H, ECO-200HD... (Other models you can see in the webshop) |                 |                  |

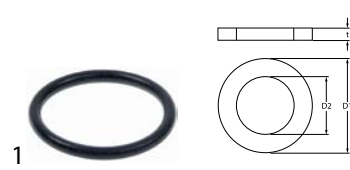

|                    |  |                 |          |
|--------------------|--|-----------------|----------|
| <b>GEV No.</b>     | 512511   | <b>Ref. No.</b> | 12115850 |
| <b>description</b> | O-ring EPDM thickness 3.53mm ID $\varnothing$ 32mm Qty 10 pcs  |                 |          |
| <b>For models:</b> | CO-500, CO-500B, CO-500BDD, CO-500DD, CO-501, CO-501B, CO-501BDD, CO-501DD, CO-501-SOFT, CO-502B, CO-502BDD, CO-502DD, CO-502W, COP-503, COP-503B, COP-503BDD, COP-503DD, COP-503-SOFT, COP-504, COP-504B, COP-504BDD, COP-504DD, COP-504W |                 |          |

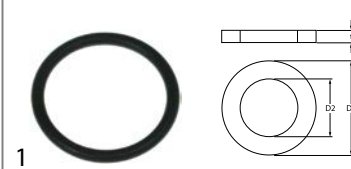

|                    |  |                 |                  |
|--------------------|--|-----------------|------------------|
| <b>GEV No.</b>     | 532548   | <b>Ref. No.</b> | 12010176 Q307068 |
| <b>description</b> | O-ring EPDM thickness 3mm ID $\varnothing$ 27mm Qty 1 pcs  |                 |                  |
| <b>For models:</b> | ECO-2700D, ECO-2700I, ECO-280D, ECO-280I, ECO-370D, ECO-370I, ECO-4000D, ECO-4000I, ECO-460D, ECO-460I, ECO-550D, ECO-550I, ECO-6000D, ECO-6000I, FI-2700D, FI-2700I, FI-280D, FI-280I, FI-370D, FI-370I, FI-4000D, FI-4000I, FI-460D, FI-460I, FI-550D, FI-550I, FI-6000D, FI-6000I |                 |                  |

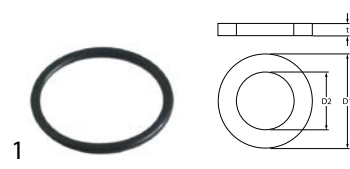

|                    |   |                 |                  |
|--------------------|---|-----------------|------------------|
| <b>GEV No.</b>     | 506015  | <b>Ref. No.</b> | 12024031 Z471109 |
| <b>description</b> | O-ring EPDM thickness 3.53mm ID $\varnothing$ 39.69mm Qty 1 pcs   |                 |                  |
| <b>For models:</b> | AD-15D, AD-21D, AD-48D, AD-64D, CO-400-SOFT, FI-48, FI-48AR, FI-48B, FI-48B-BT-UK, FI-48C, FI-48D, FI-48HY-CLINIC, FI-48W, FI-64, FI-64AR, FI-64B, FI-64B-BT-UK, FI-64C, FI-64D, FI-64HY-CLINIC, FI-64W, LVC-15D, LVC-21D |                 |                  |

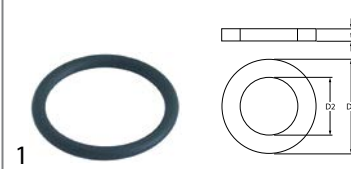



|                    |   |                 |                                   |
|--------------------|---|-----------------|-----------------------------------|
| <b>GEV No.</b>     | 505092  | <b>Ref. No.</b> | 12010062 12016701 Q307053 S312113 |
| <b>description</b> | O-ring EPDM thickness 5.34mm ID $\varnothing$ 43.82mm Qty 1 pcs   |                 |                                   |
| <b>For models:</b> | AD-15, AD-15D, AD-20C-UK, AD-21, AD-21B, AD-21BDD, AD-21C, AD-21D, AD-21DD, AD-21W, LVC-12, LVC-15, LVC-15D, LVC-21, LVC-21B, LVC-21C, LVC-21D, LVC-21W, LVR-10, LVR-14, LVR-14D, LVR-20, LVR-20B, LVR-20D, MF-21 |                 |                                   |

Зип Общепит

vsezip.ru

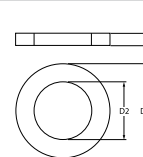
7(812)987-08-81

|  |   |
|--|---|
|  |  |
| <b>GEV No.</b> 510408  | <b>Ref. No.</b> 12039760<br>eu455002<br>Q307020                                   |
| <b>description</b>   | O-ring EPDM thickness 5.34mm ID ø 47mm Qty 1 pcs                                  |
| <b>For models:</b>   | ECO-1200, FI-1200, FI-300B, FI-300R, FI-650R, FI-900                              |

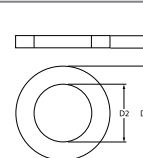
|  |  |
|--|--|
|  |   |
| <b>GEV No.</b> 505175  | <b>Ref. No.</b> 12010079<br>Q307052  |
| <b>description</b>   | O-ring EPDM thickness 5.34mm ID ø 50.16mm Qty 1 pcs  |
| <b>For models:</b>   | AD-15, AD-15D, AD-20C-UK, AD-21, AD-21B, AD-21BDD, AD-21C, AD-21D, AD-21DD, AD-21W, AD-45BBT, AD-48, AD-48B, AD-48BDD, AD-48C, AD-48D, AD-48DD, AD-48HY, AD-48W, AD-64, AD-64B, AD-64BBT, AD-64BDD, AD-64BTDD, AD-64C, AD-64CW, AD-64D, AD-64DD, AD-64HY, AD-72, AD-72W, CO-350, CO-350-B, CO-350-B-DD, CO-350-COLD, CO-350-COLD-B, CO-350-COLD-B-DD, CO-350-COLD-DD, CO-350-DD, CO-352-COLD, CO-352-COLD-B, CO-352-COLD-B-DD, CO-352-COLD-DD, CO-400, CO-400-B, CO-400-B-DD, CO-400-COLD, CO-400-COLD-B, CO-400-COLD-B-DD, CO-400-COLD-DD...(Other models you can see in the webshop) |

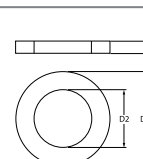
|  |   |
|--|---|
|  |    |
| <b>GEV No.</b> 510409  | <b>Ref. No.</b> 12010040<br>Q307044   |
| <b>description</b>   | O-ring EPDM thickness 5.34mm ID ø 56.52mm Qty 1 pcs   |
| <b>For models:</b>   | ECO-160, ECO-1600, ECO-160D, ECO-160I, ECO-200, ECO-200D, ECO-200H, ECO-200HD, ECO-200HI, ECO-200I, ECO-2300, ECO-2700D, ECO-2700I, ECO-280D, ECO-280I, ECO-3000, ECO-370D, ECO-370I, ECO-4000D, ECO-4000I, ECO-460D, ECO-460I, ECO-550D, ECO-550I, ECO-6000D, ECO-6000I, FI-160, FI-1600, FI-160AR, FI-160D, FI-160I, FI-200, FI-200AR, FI-200D, FI-200H, FI-200HD, FI-200HI, FI-200I, FI-200W, FI-200WL, FI-200WR, FI-2300, FI-2700D, FI-2700I, FI-280D, FI-280I, FI-3000, FI-370D, FI-370I, FI-4000D...(Other models you can see in the webshop) |

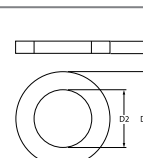
|  |   |
|--|---|
|  |    |
| <b>GEV No.</b> 691033  | <b>Ref. No.</b> 12010051<br>Q307035   |
| <b>description</b>   | O-ring EPDM thickness 5.34mm ID ø 62.87mm Qty 1 pcs   |
| <b>For models:</b>   | AD-120, AD-120B, AD-120BBTDD-UK, AD-120C, AD-120HY, AD-45BBT, AD-48, AD-48B, AD-48BDD, AD-48C, AD-48D, AD-48DD, AD-48HY, AD-48W, AD-64, AD-64B, AD-64BBT, AD-64BDD, AD-64BTDD, AD-64C, AD-64CW, AD-64D, AD-64DD, AD-64HY, AD-72, AD-72W, AD-90, AD-90BA, AD-90BBT, AD-90BDD, AD-90DD, CO-110, CO-110B, CO-110BDD, CO-110DD, CO-112, CO-112B, CO-112BDD, CO-112DD, CO-142W, CO-142WDD, CO-170, CO-170B, CO-170BDD, CO-170DD, CO-170HRS, CO-170HRSDD, CO-170HRS-SOFT, CO-170-SOFT, CO-172...(Other models you can see in the webshop) |

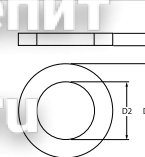
|  |  |
|--|--|
|  |   |
| <b>GEV No.</b> 505173  | <b>Ref. No.</b> 12009976<br>Q307049  |
| <b>description</b>   | O-ring EPDM thickness 5.34mm ID ø 85.09mm Qty 1 pcs  |
| <b>For models:</b>   | AD-45BBT, AD-48, AD-48B, AD-48BDD, AD-48C, AD-48D, AD-48DD, AD-48HY, AD-48W, AD-64, AD-64B, AD-64BBT, AD-64BDD, AD-64BTDD, AD-64C, AD-64CW, AD-64D, AD-64DD, AD-64HY, AD-72, AD-72W, EASY-500, EASY-500B, EASY-500DD, EASY-500HP, EASY-500HPWBDD, FI-30, FI-30AR, FI-30AR+DD, FI-30B, FI-30B-BT-UK, FI-30-UK, FI-48, FI-48AR, FI-48B, FI-48B-BT-UK, FI-48C, FI-48D, FI-48HY-CLINIC, FI-48W, FI-50, FI-60DD, FI-64, FI-64AR, FI-64B, FI-64B-BT-UK, FI-64C, FI-64D, FI-64HY-CLINIC, FI-64W...(Other models you can see in the webshop) |

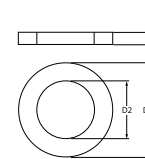
|  |   |
|--|---|
|  |    |
| <b>GEV No.</b> 532639  | <b>Ref. No.</b> 12009995<br>Q307045   |
| <b>description</b>   | O-ring EPDM thickness 5.34mm ID ø 94.62mm Qty 1 pcs   |
| <b>For models:</b>   | ECO-160, ECO-1600, ECO-160D, ECO-160I, ECO-200, ECO-200D, ECO-200H, ECO-200HD, ECO-200HI, ECO-200I, ECO-2300, ECO-280D, ECO-280I, ECO-3000, ECO-370D, ECO-370I, ECO-460D, ECO-460I, ECO-550D, ECO-550I, FI-160, FI-1600, FI-160AR, FI-160D, FI-160I, FI-200, FI-200AR, FI-200D, FI-200H, FI-200HD, FI-200HI, FI-200I, FI-200W, FI-200WL, FI-200WR, FI-2300, FI-280D, FI-280I, FI-3000, FI-370D, FI-370I, FI-460D, FI-460I, FI-550D, FI-550I |

## silicone

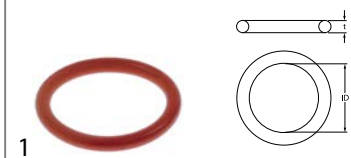
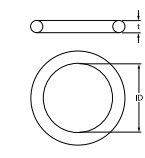
|  |   |
|--|---|
|  |  |
| <b>GEV No.</b> 532727  | <b>Ref. No.</b> 12037152<br>RT1000512   |
| <b>description</b>   | O-ring silicone thickness 3.5mm ID ø 26mm Qty 5 pcs for model SCC, CM                 |

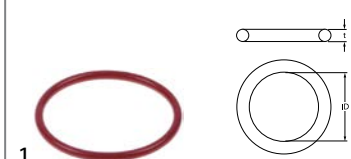
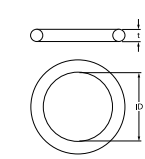
|  |   |
|--|---|
|  |  |
| <b>GEV No.</b> 532728  | <b>Ref. No.</b> 12037113<br>RT1000511   |
| <b>description</b>   | O-ring silicone thickness 3.5mm ID ø 46mm Qty 5 pcs for model SCC, CM                 |



Зип Общепит  
vsezip.ru  
(812)987-08-81



|                    |   |                 |                        |
|--------------------|---|-----------------|------------------------|
| <b>GEV No.</b>     | 512414  | <b>Ref. No.</b> | 12016812<br>RT50120560 |
| <b>description</b> | O-ring silicone thickness 3mm ID ø 47.5mm Qty 5 pcs |                 |                        |

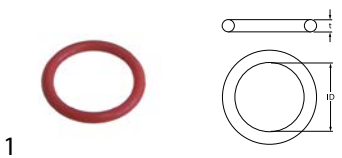

|                    |   |                 |                     |
|--------------------|---|-----------------|---------------------|
| <b>GEV No.</b>     | 532519  | <b>Ref. No.</b> | 12021028<br>S042108 |
| <b>description</b> | O-ring silicone thickness 5.34mm ID ø 53.34mm Qty 1 pcs |                 |                     |

**Viton**



|                    |  |                 |                     |
|--------------------|--|-----------------|---------------------|
| <b>GEV No.</b>     | 530027   | <b>Ref. No.</b> | 12017304<br>X012127 |
| <b>description</b> | O-ring Viton thickness 3mm ID ø 14mm Qty 1 pcs   |                 |                     |
| <b>For models:</b> | FE-710, FE-720, FE-920, FG-710, FG-71-15, FG-720, FG-72-30, FG-91-20, FG-920, FG-92-40 |                 |                     |

**miscellaneous**



|                    |  |                 |                     |
|--------------------|--|-----------------|---------------------|
| <b>GEV No.</b>     | 691010   | <b>Ref. No.</b> | 12010108<br>Q307069 |
| <b>description</b> | O-ring thickness 2.62mm ID ø 12.37mm Qty 1 pcs for water level tube  |                 |                     |
| <b>For models:</b> | ME9-10BM, ME9-10BMS, ME9-15BM, ME9-15BM316, ME9-15BMS, MG9-10BM, MG9-10BMS, MG9-15BM, MG9-15BM316, MG9-15BMS, MPE9-10BM, MPE9-10BMS, MPE9-15BM, MPE9-15BMS, MPG9-10BM, MPG9-10BMS, MPG9-15BM, MPG9-15BMS |                 |                     |

**sealing washers**

**fibre gaskets**



|                    |   |                 |                     |
|--------------------|---|-----------------|---------------------|
| <b>GEV No.</b>     | 505246  | <b>Ref. No.</b> | 12016868<br>Z953097 |
| <b>description</b> | flat gasket FIBER ED ø 17mm ID ø 13.5mm thickness 1.5mm Qty 1 pcs |                 |                     |
| <b>For models:</b> | GA-20, GA-20D, GA-40, GA-40D                                      |                 |                     |



|                    |   |                 |                     |
|--------------------|---|-----------------|---------------------|
| <b>GEV No.</b>     | 510033  | <b>Ref. No.</b> | 12009977<br>Q306013 |
| <b>description</b> | flat gasket FIBER ED ø 30mm ID ø 21mm thickness 3mm Qty 1 pcs   |                 |                     |
| <b>For models:</b> | BME9-05, BME9-05AD, BME9-05PLUS, BME9-05V-T, BME9-10, BME9-10AD, BME9-10PLUS, BME9-10V-T, BMG9-05, BMG9-05V-T, BMG9-10, BMG9-10V-T, CPE7-05, CPE7-05NC, CPE9-05, CPE9-05S, CPG7-05, CPG7-05NC, CPG9-05, CPG9-05NC, CPG9-05S, CPG9-05SNC, EPC-350, FG7-05-1C, FG7-05-2C, FG7-10-2C, FG7-104C, FG7-10-4C, FG9-05, FG9-05-1C, FG9-05-2C, FG9-05AD, FG9-05PLUS, FG9-05PLUS-S, FG9-05S, FG9-05S-1C, FG9-05S-2C, FG9-05S-AD, FG9-10, FG9-10-2C, FG9-10-4C, FG9-10AD, FG9-10PLUS, FGCL9-05, FGCL9-05-1C, FGCL9-05-2C, FGCL9-05S-1C, FGCL9-05S-2C, GA-20, GA-40...(Other models you can see in the webshop) |                 |                     |



|                    |  |                 |                     |
|--------------------|--|-----------------|---------------------|
| <b>GEV No.</b>     | 510123   | <b>Ref. No.</b> | 12016709<br>S112152 |
| <b>description</b> | flat gasket FIBER ED ø 60mm ID ø 46mm thickness 2mm Qty 1 pcs  |                 |                     |
| <b>For models:</b> | ME9-10BM, ME9-10BMS, ME9-15BM, ME9-15BMS, MG9-10, MG9-10BM, MG9-10BMS, MG9-10S, MG9-15, MG9-15BM, MG9-15BMS, MG9-15S, MG9-20, MG9-20S, MPE9-10BM, MPE9-10BMS, MPE9-15BM, MPE9-15BMS, MPG9-10, MPG9-10BM, MPG9-10BMS, MPG9-10S, MPG9-15, MPG9-15BM, MPG9-15BMS, MPG9-15S, MPG9-20, MPG9-20S |                 |                     |





|                    |   |                 |                     |
|--------------------|---|-----------------|---------------------|
| <b>GEV No.</b>     | 510153  | <b>Ref. No.</b> | 12010206<br>Q306050 |
| <b>description</b> | flat gasket fibre ED ø 12mm ID ø 6.2mm thickness 1.5mm Qty 1 pcs  |                 |                     |
| <b>For models:</b> | AD-120, AD-120B, AD-120C, AD-120CW, AD-45BBT, AD-48, AD-48B, AD-48C, AD-48D, AD-48DD, AD-48HY, AD-48W, AD-64, AD-64B, AD-64BBT, AD-64BTDD, AD-64C, AD-64CW, AD-64D, AD-64DD, AD-64HY, AD-72, AD-72W, AD-90, AD-90BA, AD-90BBT, AD-90BDD, AD-90DD, ADE-120, ADE-120B, ECO-120, ECO-120B, ECO-160, ECO-160D, ECO-160I, ECO-200, ECO-200D, ECO-200H, ECO-200HD, ECO-200HI, ECO-200I, FI-100, FI-100AR, FI-100B, FI-100BBT-UK, FI-120, FI-120AR+DD, FI-120B, FI-120C, FI-120HY-CLINIC...(Other models you can see in the webshop) |                 |                     |





|                    |  |                 |                     |
|--------------------|--|-----------------|---------------------|
| <b>GEV No.</b>     | 507332   | <b>Ref. No.</b> | 12010260<br>Q306024 |
| <b>description</b> | flat gasket fibre ED ø 18mm ID ø 12mm thickness 2mm Qty 1 pcs  |                 |                     |
| <b>For models:</b> | AD-120, AD-120B, AD-120BBTDD-UK, AD-120C, AD-120CW, AD-120HY, AD-45BBT, AD-48, AD-48B, AD-48BDD, AD-48C, AD-48D, AD-48DD, AD-48HY, AD-48W, AD-64, AD-64B, AD-64BBT, AD-64BDD, AD-64BTDD, AD-64C, AD-64CW, AD-64D, AD-64DD, AD-64HY, AD-72, AD-72W, AD-90, AD-90BA, AD-90BBT, AD-90BDD, AD-90DD, ADE-120, ADE-120B, BME7-05, BME7-10, BME9-05, BME9-05AD, BME9-05PLUS, BME9-05V-T, BME9-10, BME9-10AD, BME9-10PLUS, BME9-10V-T, BMG7-10, BMG9-04S, BMG9-05, BMG9-05V-T, BMG9-10, BMG9-10V-T...(Other models you can see in the webshop) |                 |                     |

Зип Общепит  
vsezip.ru  
7(812)987-08-81

|   |   |                 |                     |
|---|---|-----------------|---------------------|
|  |   |                 |                     |
| 1   |   |                 |                     |
| <b>GEV No.</b>  | 510179  | <b>Ref. No.</b> | 12010145<br>Q306012 |
| <b>description</b>  | flat gasket fibre ED ø 18mm ID ø 13mm thickness 1.5mm Qty 1 pcs   |                 |                     |
| <b>For models:</b>  | BG9-05, BG9-10, CG-200S, CG-210, CG-210G, CG-300S, CG-310, CG-310G, CG9-51L, CG9-51LC, CG9-51R, CG9-51RC, CG-HP-20, FI-5420, FI-7630, HCG-10-11, HCG-10-21, HCG-20-11, HCG-20-21, HCG-2-10-11, HCG-2-20-11, HCG-6-11, HG-10-11, HG-10-21, HG-2-10-11, HGC-10-11, HGC-10-21, HGC-20-21, HGC-6-11, HGP-10-21, HGP-20-21, HGV-10-11, HGV-10-21, HGV-20-11, HMG-20-11, HVG-10-11, HVG-10-11UL, HVG-10-21, HVG-10-21UL, HVG-20-11, HVG-20-21, HVG-2-10-11, HVG-2-20-21, MFHVG-10-11, MFHVG-10-21, MG9-10, MG9-10BM, MG9-15, MG9-15BM...(Other models you can see in the webshop) |                 |                     |

|   |   |                 |                     |
|---|---|-----------------|---------------------|
|  |   |                 |                     |
| 1   |   |                 |                     |
| <b>GEV No.</b>  | 510164  | <b>Ref. No.</b> | 12010055<br>Q306052 |
| <b>description</b>  | flat gasket fibre ED ø 24mm ID ø 16mm thickness 3mm Qty 1 pcs   |                 |                     |
| <b>For models:</b>  | BME7-05, BME7-10, BMG7-10, CG-1002, CG-1502, CG-2002, CG7-11, CG7-41, CG7-61, CG9-11, CG9-41, CG9-51L, CG9-51LC, CG9-51R, CG9-51RC, CG9-61, CG9-82, CGB7-61, CGE7-41, CGE9-41, CGP9-11, CPG7-05, CPG9-05, CPG9-05NC, FG7-05-1C, FG7-05-2C, FG-710, FG7-10-2C, FG7-104C, FG7-10-4C, FG-720, FG9-05, FG9-05-1C, FG9-05-2C, FG9-05AD, FG9-05PLUS, FG9-05PLUS-S, FG9-05S-1C, FG9-05S-2C, FG9-05S-AD, FG9-10, FG9-10-2C, FG9-10-4C, FG9-10AD, FG9-10PLUS, FGCL9-05-1C, FGCL9-05-2C, FGCL9-05S-1C, FGCL9-05S-2C, FTG9-11L...(Other models you can see in the webshop) |                 |                     |

|   |   |                 |                     |
|---|---|-----------------|---------------------|
|  |   |                 |                     |
| 1   |   |                 |                     |
| <b>GEV No.</b>  | 510129  | <b>Ref. No.</b> | 12010207<br>Q306039 |
| <b>description</b>  | flat gasket fibre ED ø 25mm ID ø 16.5mm thickness 1.5mm Qty 1 pcs   |                 |                     |
| <b>For models:</b>  | BME7-05, BME7-10, BME9-05, BME9-05AD, BME9-05PLUS, BME9-05V-T, BME9-10, BME9-10AD, BME9-10PLUS, BME9-10V-T, BMG7-10, BMG-9045, FF-35, HE-10-11, HE-10-21, HE-2-10-11, HE-5-11, HEI-10-21, HEM-10-11, HEM-10-21, HEM-20-11, HEM-6-11, HEP-10-11, HEP-10-21, HEP-20-11, HEP-6-11, HG-10-11, HG-10-21, HG-2-10-11, HGC-10-21, HGP-10-21, HGV-10-11, HGV-10-21, HGV-20-11, ME7-10BM, ME9-10BM, ME9-10BMS, ME9-15BM, ME9-15BMS, MG9-10BM, MG9-10BMS, MG9-15BM, MG9-15BMS, MPE9-10BM, MPE9-10BMS, MPE9-15BM, MPE9-15BMS, MPG9-10BM, MPG9-10BMS, MPG9-15BM...(Other models you can see in the webshop) |                 |                     |

|   |  |                 |                     |
|---|--|-----------------|---------------------|
|  |  |                 |                     |
| 1   |  |                 |                     |
| <b>GEV No.</b>  | 510166   | <b>Ref. No.</b> | 12019584<br>Q306049 |
| <b>description</b>  | flat gasket fibre ED ø 31.3mm ID ø 26.3mm thickness 1.2mm Qty 1 pcs  |                 |                     |
| <b>For models:</b>  | ME7-10BM, ME9-10BM, ME9-10BMS, ME9-15BM, ME9-15BMS, MG7-10BM, MG9-10BM, MG9-10BMS, MG9-15BM, MG9-15BMS, MPE9-10BM, MPE9-10BMS, MPE9-15BM, MPE9-15BMS, MPG9-10BM, MPG9-10BMS, MPG9-15BM, MPG9-15BMS |                 |                     |

|   |   |                 |                     |
|---|---|-----------------|---------------------|
|  |   |                 |                     |
| 1   |   |                 |                     |
| <b>GEV No.</b>  | 510152  | <b>Ref. No.</b> | 12010203<br>Q306038 |
| <b>description</b>  | flat gasket fibre ED ø 31mm ID ø 21mm thickness 1.5mm Qty 1 pcs   |                 |                     |
| <b>For models:</b>  | ADE-120, ADE-120B, BME7-05, BME7-10, BME9-05, BME9-10, BMG7-10, BMG-9045, BMG9-05, BMG9-10, CPE9-05, CPE9-05S, CPG7-05, CPG9-05, CPG9-05NC, CPG9-05S, CPG9-05SNC, ECO-120, ECO-1200, ECO-120B, ECO-160, ECO-1600, ECO-160D, ECO-160I, ECO-200, ECO-200D, ECO-200H, ECO-200HD, ECO-200HI, ECO-200I, ECO-2300, ECO-2700D, ECO-2700I, ECO-280D, ECO-280I, ECO-3000, ECO-370D, ECO-370I, ECO-4000D, ECO-4000I, ECO-460D, ECO-460I, ECO-550D, ECO-550I, ECO-6000D, ECO-6000I, GA-20, GA-20D, GA-40, GA-40D...(Other models you can see in the webshop) |                 |                     |

|   |  |                 |                      |
|---|--|-----------------|----------------------|
|  |  |                 |                      |
| 1   |  |                 |                      |
| <b>GEV No.</b>  | 510406   | <b>Ref. No.</b> | 12035981<br>ICR09387 |
| <b>description</b>  | flat gasket fibre ED ø 60mm ID ø 48mm thickness 3mm for thread 1½" Qty 1 pcs |                 |                      |

### rubber gaskets

|  |   |                 |                     |
|--|---|-----------------|---------------------|
|  |   |                 |                     |
| 1  |   |                 |                     |
| <b>GEV No.</b>   | 505245  | <b>Ref. No.</b> | 12039712<br>Q307038 |
| <b>description</b>   | flat gasket ED ø 77mm ID ø 48mm thickness 1.5mm Qty 1 pcs |                 |                     |
| <b>For models:</b>   | ECO-1200, FI-1200, FI-900                                 |                 |                     |

|   |   |                 |                     |
|---|---|-----------------|---------------------|
|  |   |                 |                     |
| 1   |   |                 |                     |
| <b>GEV No.</b>  | 510169  | <b>Ref. No.</b> | 12039857<br>R725032 |
| <b>description</b>  | flat gasket rubber ED ø 16mm ID ø 10mm thickness 2mm Qty 1 pcs        |                 |                     |
| <b>For models:</b>  | HMG-10-11, HMG-10-11UL, HMG-10-21, HMG-10-21UL, HMG-2-10-11, HMG-6-11 |                 |                     |

|   |  |                 |                     |
|---|--|-----------------|---------------------|
|  |  |                 |                     |
| 1   |  |                 |                     |
| <b>GEV No.</b>  | 505199   | <b>Ref. No.</b> | 12010191<br>Q307031 |
| <b>description</b>  | flat gasket rubber ED ø 24mm ID ø 14mm thickness 3mm Qty 1 pcs   |                 |                     |
| <b>For models:</b>  | AD-45BBT, AD-48B, AD-48BDD, AD-48C, AD-48HY, AD-48W, AD-64B, AD-64BBT, AD-64BDD, AD-64C, AD-64CW, AD-64HY, BME7-05, BME7-10, BMG7-10, ECO-120, ECO-1200, FI-100, FI-100AR, FI-100B, FI-100BBT-UK, FI-120, FI-1200, FI-120B, FI-120W, FI-200W, FI-30, FI-300B, FI-300R, FI-30B, FI-30B-BT-UK, FI-48, FI-48AR, FI-48B, FI-48B-BT-UK, FI-48C, FI-48HY-CLINIC, FI-48W, FI-50, FI-64, FI-64AR, FI-64B, FI-64B-BT-UK, FI-64C, FI-64HY-CLINIC, FI-64W, FI-650R, FI-72, FI-80, FI-80BBT-UK...(Other models you can see in the webshop) |                 |                     |

|                    |  |                 |                     |
|--------------------|--|-----------------|---------------------|
| <b>GEV No.</b>     | 900909   | <b>Ref. No.</b> | 12018710<br>Z401905 |
| <b>description</b> | flat gasket rubber ED ø 31mm ID ø 18mm thickness 2mm Qty 1 pcs |                 |                     |
| <b>For models:</b> | LVR-10, LVR-14, LVR-20, LVR-20B                                |                 |                     |



|                    |  |                 |                     |
|--------------------|--|-----------------|---------------------|
| <b>GEV No.</b>     | 515018   | <b>Ref. No.</b> | 12009947<br>Q307032 |
| <b>description</b> | flat gasket rubber ED ø 32mm ID ø 21mm thickness 3mm Qty 1 pcs   |                 |                     |
| <b>For models:</b> | AD-120, AD-120B, AD-120BBTDD-UK, AD-120C, AD-120CW, AD-120HY, AD-90, AD-90BA, AD-90BBT, AD-90BDD, AD-90DD, ADE-120, ADE-120B, BME7-05, BME7-10, BME9-05, BME9-05AD, BME9-05PLUS, BME9-05V-T, BME9-10, BME9-10AD, BME9-10PLUS, BME9-10V-T, BMG7-10, BMG9-05, BMG9-05V-T, BMG9-10, BMG9-10V-T, CO-142W, CO-142WDD, COP-174W, COP-174WHR, ECO-120, ECO-1200, ECO-120B, ECO-160, ECO-1600, ECO-160D, ECO-160I, ECO-200, ECO-200D, ECO-200H, ECO-200HD, ECO-200HI, ECO-200I, ECO-2300, ECO-2700D, ECO-2700I, ECO-280D, ECO-280I...(Other models you can see in the webshop) |                 |                     |



|                    |  |                 |                     |
|--------------------|--|-----------------|---------------------|
| <b>GEV No.</b>     | 510154   | <b>Ref. No.</b> | 12010053<br>Q307029 |
| <b>description</b> | flat gasket rubber ED ø 33mm ID ø 26mm thickness 2mm Qty 1 pcs   |                 |                     |
| <b>For models:</b> | ECO-120, FE-18, FE-25, FG-1-40, FG-2-80, FI-100, FI-120, FI-120W, FI-30, FI-48, FI-48B, FI-48W, FI-50, FI-64, FI-64B, FI-64W, FI-72, LVC-21W, MF-21, MF-48, MF-64, MG-9150BM |                 |                     |



|                    |   |                 |                     |
|--------------------|---|-----------------|---------------------|
| <b>GEV No.</b>     | 505161  | <b>Ref. No.</b> | 12010028<br>Q307027 |
| <b>description</b> | flat gasket rubber ED ø 45mm ID ø 35mm thickness 2mm Qty 1 pcs  |                 |                     |
| <b>For models:</b> | BMG-9045, ECO-1200, ECO-1600, ECO-2300, ECO-2700D, ECO-2700I, ECO-280D, ECO-280I, ECO-3000, ECO-370D, ECO-370I, ECO-4000D, ECO-4000I, ECO-460D, ECO-460I, ECO-550D, ECO-550I, ECO-6000D, ECO-6000I, FI-1200, FI-1600, FI-2300, FI-2700D, FI-2700I, FI-280D, FI-280I, FI-3000, FI-300B, FI-300R, FI-370D, FI-370I, FI-4000D, FI-4000I, FI-460D, FI-460I, FI-550D, FI-550I, FI-6000D, FI-6000I, FI-650R, FI-900 |                 |                     |



|                    |  |                 |                     |
|--------------------|--|-----------------|---------------------|
| <b>GEV No.</b>     | 501302   | <b>Ref. No.</b> | 12023554<br>R675007 |
| <b>description</b> | flat gasket rubber ED ø 57mm ID ø 30mm thickness 2mm Qty 1 pcs   |                 |                     |
| <b>For models:</b> | AD-45BBT, AD-48HY, AD-64BBT, AD-64BTDD, AD-64HY, EASY-500HPWBDD, FI-30B-BT-UK, FI-48B-BT-UK, FI-48HY-CLINIC, FI-64B-BT-UK, FI-64HY-CLINIC, HEI-10-11, HEI-20-11, HEI-6-11, HEM-10-11, HEM-20-11, HEM-6-11, HEP-10-11, HEP-20-11, HEP-6-11, HME-10-11, HME-10-21, HME-20-11, HME-20-21, HME-2-10-11, HME-2-20-11, HME-6-11, HMI-10-11, HMI-10-11UL, HMI-10-21, HMI-10-21UL, HMI-2-10-11, HMI-6-11, HMI-6-11UL, HMM-10-11, HMM-10-11UL, HMM-10-21, HMM-10-21UL, HMM-20-11, HMM-20-11UL, HMM-20-21, HMM-20-21UL, HMM-2-10-11, HMM-2-20-11, HMM-40-11-USMC, HMM-6-11, HMM-6-11UL, HMP-10-11, HMP-20-11...(Other models you can see in the webshop) |                 |                     |



|                    |   |                 |                     |
|--------------------|---|-----------------|---------------------|
| <b>GEV No.</b>     | 505224  | <b>Ref. No.</b> | 12009960<br>Q307058 |
| <b>description</b> | flat gasket rubber ED ø 50mm ID ø 44mm thickness 2mm Qty 1 pcs  |                 |                     |
| <b>For models:</b> | AD-120, AD-120B, AD-120BBTDD-UK, AD-120C, AD-120CW, AD-120HY, AD-90, AD-90BA, AD-90BBT, AD-90BDD, AD-90DD, ADE-120, ADE-120B, ECO-120, ECO-120B, ECO-160, ECO-160D, ECO-160I, ECO-200, ECO-200D, ECO-200H, ECO-200HD, ECO-200HI, ECO-200I, ECO-370D, ECO-370I, ECO-550D, ECO-550I, FI-100, FI-100AR, FI-100B, FI-100BBT-UK, FI-120, FI-120AR+DD, FI-120B, FI-120C, FI-120HY-CLINIC, FI-120W, FI-160, FI-160AR, FI-160D, FI-160I, FI-200, FI-200AR, FI-200D, FI-200H, FI-200HD, FI-200HI, FI-200I, FI-200W...(Other models you can see in the webshop) |                 |                     |



|                    |   |                 |                     |
|--------------------|---|-----------------|---------------------|
| <b>GEV No.</b>     | 505223  | <b>Ref. No.</b> | 12009939<br>Q307009 |
| <b>description</b> | flat gasket rubber ED ø 70mm ID ø 48mm thickness 1.5mm Qty 1 pcs  |                 |                     |
| <b>For models:</b> | BMG-9045, ECO-1200, ECO-1600, ECO-2300, ECO-2700D, ECO-2700I, ECO-280D, ECO-280I, ECO-3000, ECO-370D, ECO-370I, ECO-4000D, ECO-4000I, ECO-460D, ECO-460I, ECO-550D, ECO-550I, ECO-6000D, ECO-6000I, FI-1200, FI-1600, FI-2300, FI-2700D, FI-2700I, FI-280D, FI-280I, FI-3000, FI-300B, FI-300R, FI-370D, FI-370I, FI-4000D, FI-4000I, FI-460D, FI-460I, FI-550D, FI-550I, FI-6000D, FI-6000I, FI-650R, FI-900 |                 |                     |



|                    |   |                 |                     |
|--------------------|---|-----------------|---------------------|
| <b>GEV No.</b>     | 505247  | <b>Ref. No.</b> | 12039795<br>Q307024 |
| <b>description</b> | flat gasket rubber ED ø 72mm ID ø 54mm thickness 2mm Qty 1 pcs  |                 |                     |
| <b>For models:</b> | ECO-280D, ECO-280I, ECO-370D, ECO-370I, ECO-460D, ECO-460I, ECO-550D, ECO-550I, FI-280D, FI-280I, FI-300B, FI-300R, FI-370D, FI-370I, FI-460D, FI-460I, FI-550D, FI-550I, FI-650R |                 |                     |



|                    |   |                 |                     |
|--------------------|---|-----------------|---------------------|
| <b>GEV No.</b>     | 505194  | <b>Ref. No.</b> | 12009937<br>Q307059 |
| <b>description</b> | flat gasket rubber ED ø 72mm ID ø 57mm thickness 2mm Qty 1 pcs  |                 |                     |
| <b>For models:</b> | AD-120, AD-120B, AD-120BBTDD-UK, AD-120C, AD-120CW, AD-120HY, AD-90, AD-90BA, AD-90BBT, AD-90BDD, AD-90DD, ADE-120, ADE-120B, ECO-120, ECO-120B, ECO-160, ECO-160D, ECO-160I, ECO-200, ECO-200D, ECO-200H, ECO-200HD, ECO-200HI, ECO-200I, ECO-2700D, ECO-2700I, ECO-280D, ECO-280I, ECO-370D, ECO-370I, ECO-4000D, ECO-4000I, ECO-460D, ECO-460I, ECO-550D, ECO-550I, ECO-6000D, ECO-6000I, FI-100, FI-100AR, FI-100B, FI-100BBT-UK, FI-120, FI-120AR+DD, FI-120B, FI-120C, FI-120HY-CLINIC, FI-120W, FI-160, FI-160AR...(Other models you can see in the webshop) |                 |                     |

Зип.Общепит

plastic gaskets

vsezip.ru

+7(812)987-08-81

|   |  |                 |                     |
|---|--|-----------------|---------------------|
|  |  |                 |                     |
| 1   |  |                 |                     |
| <b>GEV No.</b>  | 510832   | <b>Ref. No.</b> | 12023571<br>Z310902 |
| <b>description</b>  | flat gasket rubber ED ø 92mm ID ø 66mm thickness 2mm Qty 1 pcs equiv. no. 200906/33456   |                 |                     |
| <b>For models:</b>  | ECO-2700D, ECO-2700I, ECO-280D, ECO-280I, ECO-370D, ECO-370I, ECO-4000D, ECO-4000I, ECO-460D, ECO-460I, ECO-550D, ECO-550I, ECO-6000D, ECO-6000I, FI-2700D, FI-2700I, FI-280D, FI-280I, FI-370D, FI-370I, FI-4000D, FI-4000I, FI-460D, FI-460I, FI-550D, FI-550I, FI-6000D, FI-6000I |                 |                     |

|   |   |                 |                     |
|---|---|-----------------|---------------------|
|  |   |                 |                     |
| 1   |   |                 |                     |
| <b>GEV No.</b>  | 691693  | <b>Ref. No.</b> | 12019066<br>R725031 |
| <b>description</b>  | flat gasket rubber ED ø 94mm ID ø 54mm thickness 4mm Qty 1 pcs        |                 |                     |
| <b>For models:</b>  | HMG-10-11, HMG-10-11UL, HMG-10-21, HMG-10-21UL, HMG-2-10-11, HMG-6-11 |                 |                     |

|   |  |                 |                        |
|---|--|-----------------|------------------------|
|  |  |                 |                        |
| 1   |  |                 |                        |
| <b>GEV No.</b>  | 560616   | <b>Ref. No.</b> | 12037537<br>RT51101024 |
| <b>description</b>  | gasket ED ø 24mm ID ø 15mm thickness 3mm Qty 5 pcs for model C-Line, CPC, SCC 61-202 |                 |                        |

|   |   |                 |                     |
|---|---|-----------------|---------------------|
|  |   |                 |                     |
| 1   |   |                 |                     |
| <b>GEV No.</b>  | 505249  | <b>Ref. No.</b> | 12009936<br>Q307011 |
| <b>description</b>  | gasket ED ø 56mm ID ø 39mm thickness 1mm Qty 1 pcs  |                 |                     |
| <b>For models:</b>  | ECO-1600, ECO-2300, ECO-280D, ECO-280I, ECO-3000, ECO-370D, ECO-370I, ECO-460D, ECO-460I, ECO-550D, ECO-550I, FI-1600, FI-2300, FI-280D, FI-280I, FI-3000, FI-370D, FI-370I, FI-460D, FI-460I, FI-550D, FI-550I |                 |                     |

|   |   |                 |                        |
|---|---|-----------------|------------------------|
|  |   |                 |                        |
| 1   |   |                 |                        |
| <b>GEV No.</b>  | 560617  | <b>Ref. No.</b> | 12037232<br>RT50120539 |
| <b>description</b>  | gasket rubber ED ø 19.5mm ID ø 12mm thickness 2.3mm Qty 5 pcs |                 |                        |

|   |  |                 |                     |
|---|--|-----------------|---------------------|
|  |  |                 |                     |
| 1   |  |                 |                     |
| <b>GEV No.</b>  | 510213   | <b>Ref. No.</b> | 12020523<br>X163016 |
| <b>description</b>  | gasket rubber ED ø 7mm ID ø 3mm thickness 6mm Qty 1 pcs      |                 |                     |
| <b>For models:</b>  | FE9-05, FE9-05S, FE9-05USMC, FE9-10, FG9-05, FG9-05S, FG9-10 |                 |                     |

|   |  |                 |                     |
|---|--|-----------------|---------------------|
|  |  |                 |                     |
| 1   |  |                 |                     |
| <b>GEV No.</b>  | 510212   | <b>Ref. No.</b> | 12019069<br>Q308008 |
| <b>description</b>  | flat gasket plastic ED ø 12mm ID ø 7.3mm thickness 2mm Qty 1 pcs |                 |                     |
| <b>For models:</b>  | FI-300B, FI-300R, FI-650R  |                 |                     |

## copper gaskets

## DIN-7603-A

|   |   |                 |          |
|---|---|-----------------|----------|
|  |   |                 |          |
| 1   |   |                 |          |
| <b>GEV No.</b>  | 528197  | <b>Ref. No.</b> | 12037845 |
| <b>description</b>  | flat gasket copper ED ø 10mm ID ø 6mm thickness 1mm Qty 1 pcs |                 |          |

|   |  |                 |            |
|---|--|-----------------|------------|
|  |  |                 |            |
| 1   |  |                 |            |
| <b>GEV No.</b>  | 530883   | <b>Ref. No.</b> | RT13150101 |
| <b>description</b>  | flat gasket copper ED ø 10mm ID ø 6mm thickness 1mm Qty 10 pcs |                 |            |

|   |  |                 |                        |
|---|--|-----------------|------------------------|
|  |  |                 |                        |
| 1   |  |                 |                        |
| <b>GEV No.</b>  | 560200   | <b>Ref. No.</b> | 12036402<br>RT13150105 |
| <b>description</b>  | flat gasket copper ED ø 16mm ID ø 10mm thickness 1.5mm Qty 1 pcs |                 |                        |

|   |   |                 |                        |
|---|---|-----------------|------------------------|
|  |   |                 |                        |
| 1   |   |                 |                        |
| <b>GEV No.</b>  | 560615  | <b>Ref. No.</b> | 12037551<br>RT13150109 |
| <b>description</b>  | gasket copper ED ø 16mm ID ø 8.5mm thickness 1.2mm for combi-steamer suitable for CPC Qty 5 pcs |                 |                        |

|   |   |                 |                        |
|---|---|-----------------|------------------------|
|  |   |                 |                        |
| 1   |   |                 |                        |
| <b>GEV No.</b>  | 560614  | <b>Ref. No.</b> | 12036587<br>RT13150104 |
| <b>description</b>  | gasket copper ED ø 20mm ID ø 16mm thickness 1.5mm suitable for CPC Qty 10 pcs |                 |                        |



Зип Общепит

vsezip.ru

7(812)987-08-81

PTFE gaskets



1

|                    |  |                 |                     |
|--------------------|--|-----------------|---------------------|
| <b>GEV No.</b>     | 505226   | <b>Ref. No.</b> | 12013644<br>Q308009 |
| <b>description</b> | slide ring PTFE ED ø 19mm ID ø 7.5mm thickness 2mm Qty 1 pcs |                 |                     |
| <b>For models:</b> | FI-300B, FI-300R, FI-650R                                    |                 |                     |



1

|                    |  |                 |                     |
|--------------------|--|-----------------|---------------------|
| <b>GEV No.</b>     | 505225   | <b>Ref. No.</b> | 12009922<br>Q308012 |
| <b>description</b> | slide ring PTFE ED ø 30mm ID ø 10mm thickness 3mm for hood joint Qty 1 pcs   |                 |                     |
| <b>For models:</b> | AD-120, AD-120B, AD-120BBTDD-UK, AD-120C, AD-120CW, AD-120HY, AD-90, AD-90BA, AD-90BBT, AD-90BDD, AD-90DD, ADE-120, ADE-120B, ECO-120, ECO-120B, FI-100, FI-100AR, FI-100B, FI-100BBT-UK, FI-120, FI-120AR+DD, FI-120B, FI-120C, FI-120HY-CLINIC, FI-120W, FI-80, FI-80AR, FI-80BBT-UK, FI-80W, FI-E-100, LABP-1000, LABP-1200, LABP-800, MF-120 |                 |                     |

foam rubber gaskets



1

|                    |  |                 |          |
|--------------------|--|-----------------|----------|
| <b>GEV No.</b>     | 505408   | <b>Ref. No.</b> | 12041815 |
| <b>description</b> | foam rubber gasket W 15mm thickness 2mm self-adhesive Qty 1 suitable for FAGOR control panel combi-steamer L 540mm   |                 |          |
| <b>For models:</b> | ACE-061, ACE-101, ACE-102, ACE-201, ACE-202, ACG-061, ACG-101, ACG-102, ACG-201, ACG-202, AE-061, AE-061W, AE-101, AE-101W, AE-102, AE-102W, AE-201, AE-202, AG-061, AG-061W, AG-101, AG-101W, AG-102, AG-102W, AG-201, AG-202, APE-061, APE-061W, APE-101, APE-101W, APE-102, APE-102W, APE-201, APE-202, APG-061, APG-061W, APG-101, APG-101W, APG-102, APG-102W, APG-201, APG-202 |                 |          |



1

|                    |   |                 |                     |
|--------------------|---|-----------------|---------------------|
| <b>GEV No.</b>     | 505250  | <b>Ref. No.</b> | 12021459<br>Z680532 |
| <b>description</b> | foam rubber gasket W 20mm thickness 5mm Qty 720mm |                 |                     |
| <b>For models:</b> | ECO-1200, FI-1200, FI-900                         |                 |                     |



1

|                    |   |                 |                     |
|--------------------|---|-----------------|---------------------|
| <b>GEV No.</b>     | 505248  | <b>Ref. No.</b> | 12023929<br>Z950318 |
| <b>description</b> | foam rubber gasket W 21mm thickness 1.5mm self-adhesive Qty 350mm |                 |                     |
| <b>For models:</b> | GA-20, GA-20D, GA-40, GA-40D                                      |                 |                     |



1

|                    |   |                 |                     |
|--------------------|---|-----------------|---------------------|
| <b>GEV No.</b>     | 505237  | <b>Ref. No.</b> | 12025277<br>Z400309 |
| <b>description</b> | foam rubber gasket W 8mm thickness 2mm self-adhesive Qty 450mm  |                 |                     |
| <b>For models:</b> | AD-15, AD-15D, LVC-12, LVC-15, LVC-15D, LVR-10, LVR-14, LVR-14D |                 |                     |



1

|                    |  |                 |                     |
|--------------------|--|-----------------|---------------------|
| <b>GEV No.</b>     | 505264   | <b>Ref. No.</b> | 12024174<br>Z200313 |
| <b>description</b> | foam rubber gasket W 9mm thickness 2.5mm self-adhesive Qty 625mm   |                 |                     |
| <b>For models:</b> | AD-45BBT, AD-48, AD-48B, AD-48BDD, AD-48C, AD-48D, AD-48DD, AD-48HY, AD-48W, AD-64, AD-64B, AD-64BBT, AD-64BDD, AD-64BTDD, AD-64C, AD-64CW, AD-64D, AD-64DD, AD-64HY, AD-72, AD-72W, EASY-500, EASY-500B, EASY-500DD, EASY-500HP, EASY-500HPWBDD, FI-30, FI-30AR, FI-30AR+DD, FI-30B, FI-30B-BT-UK, FI-30-UK, FI-48, FI-48AR, FI-48B, FI-48B-BT-UK, FI-48C, FI-48D, FI-48HY-CLINIC, FI-48W, FI-50, FI-60DD, FI-64, FI-64AR, FI-64B, FI-64B-BT-UK, FI-64C, FI-64D, FI-64HY-CLINIC, FI-64W...(Other models you can see in the webshop) |                 |                     |

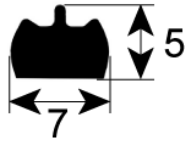

1

|                    |   |                 |                        |
|--------------------|---|-----------------|------------------------|
| <b>GEV No.</b>     | 901454  | <b>Ref. No.</b> | 12034523<br>RT51001011 |
| <b>description</b> | gasket for control panel L 2000mm foam rubber self-adhesive |                 |                        |

shaft gaskets

shaft gaskets



1

|                    |  |                 |                                   |
|--------------------|--|-----------------|-----------------------------------|
| <b>GEV No.</b>     | 691049   | <b>Ref. No.</b> | 12024510<br>R012635000<br>R662627 |
| <b>description</b> | shaft seal ID ø 17mm ED ø 28mm thickness 7mm   |                 |                                   |
| <b>For models:</b> | ACE-061, ACE-101, ACE-102, ACE-201, ACE-202, ACG-061, ACG-101, ACG-102, ACG-201, ACG-202, AE-061, AE-061W, AE-101, AE-101W, AE-102, AE-102W, AE-201, AE-202, AG-061, AG-061W, AG-101, AG-101W, AG-102, AG-102W, AG-201, AG-202, APE-061, APE-061W, APE-101, APE-101W, APE-102, APE-102W, APE-201, APE-202, APG-061, APG-061W, APG-101, APG-101W, APG-102, APG-102W, APG-201, APG-202, COE-061, COE-101, COE-102, COE-201, COE-202, COG-061, COG-101, COG-102...(Other models you can see in the webshop) |                 |                                   |



1

|                    |   |                 |                     |
|--------------------|---|-----------------|---------------------|
| <b>GEV No.</b>     | 698001  | <b>Ref. No.</b> | 12025169<br>Z105016 |
| <b>description</b> | shaft seal ID $\varnothing$ 20mm ED $\varnothing$ 35mm thickness 7mm  |                 |                     |
| <b>For models:</b> | ECO-160, ECO-1600, ECO-160D, ECO-160I, ECO-200, ECO-200D, ECO-200H, ECO-200HD, ECO-200HI, ECO-200I, ECO-2300, ECO-280D, ECO-280I, ECO-3000, ECO-370D, ECO-370I, ECO-460D, ECO-460I, ECO-550D, ECO-550I, FI-160, FI-1600, FI-160AR, FI-160D, FI-160I, FI-200, FI-200AR, FI-200D, FI-200H, FI-200HD, FI-200HI, FI-200I, FI-200W, FI-200WL, FI-200WR, FI-2300, FI-280D, FI-280I, FI-3000, FI-370D, FI-370I, FI-460D, FI-460I, FI-550D, FI-550I |                 |                     |



1

|                    |                                     |                 |            |
|--------------------|-------------------------------------|-----------------|------------|
| <b>GEV No.</b>     | 510574                              | <b>Ref. No.</b> | RT50010211 |
| <b>description</b> | shaft sealing type 20 for fan motor |                 |            |

## miscellaneous



1

|                    |  |                 |                        |
|--------------------|--|-----------------|------------------------|
| <b>GEV No.</b>     | 510573   | <b>Ref. No.</b> | 12033667<br>RT50010207 |
| <b>description</b> | shaft seal ID $\varnothing$ 17mm ED $\varnothing$ 29mm thickness 4.5mm |                 |                        |



1

|                    |  |                 |                        |
|--------------------|--|-----------------|------------------------|
| <b>GEV No.</b>     | 511682   | <b>Ref. No.</b> | 12034102<br>RT85141343 |
| <b>description</b> | shaft seal kit ID $\varnothing$ 17mm ED $\varnothing$ 29mm shaft seal flange mounting gauge with mountign material |                 |                        |

## special gaskets

## for combi-steamers



1

|                    |  |                 |                        |
|--------------------|--|-----------------|------------------------|
| <b>GEV No.</b>     | 560612   | <b>Ref. No.</b> | 12036211<br>RT51101310 |
| <b>description</b> | flange gasket ED $\varnothing$ 79mm ID $\varnothing$ 51mm thickness 2mm hole distance 34mm CPC-Linie 101-201/G |                 |                        |

Зип Общепит

vsezip.ru

7(812)987-08-81

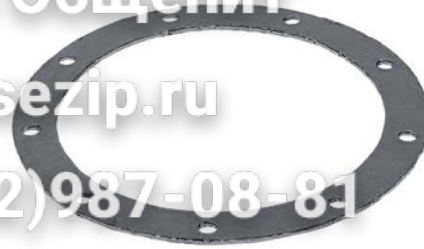

1

|                    |  |                 |                        |
|--------------------|--|-----------------|------------------------|
| <b>GEV No.</b>     | 560599   | <b>Ref. No.</b> | 12034765<br>RT51101311 |
| <b>description</b> | gasket ED $\varnothing$ 132mm ID $\varnothing$ 105mm thickness 2mm CPC-Linie CM 61-202/G |                 |                        |



1

|                    |  |                 |                       |
|--------------------|--|-----------------|-----------------------|
| <b>GEV No.</b>     | 560622   | <b>Ref. No.</b> | 12036615<br>RT7000242 |
| <b>description</b> | gasket ED $\varnothing$ 82mm ID $\varnothing$ 50mm thickness 2.5mm hole distance 50mm SCC Line since 04/04 |                 |                       |



1

|                    |   |                 |                       |
|--------------------|---|-----------------|-----------------------|
| <b>GEV No.</b>     | 699803  | <b>Ref. No.</b> | 12040239<br>RT7200020 |
| <b>description</b> | gasket L 139mm W 130mm silicone thickness 4mm |                 |                       |



1

|                    |  |                 |                       |
|--------------------|--|-----------------|-----------------------|
| <b>GEV No.</b>     | 560613   | <b>Ref. No.</b> | 12037070<br>RT7400301 |
| <b>description</b> | gasket L 43mm W 67mm thickness 4mm SCC, CM61-202 since 06/2007 for combi-steamer |                 |                       |



1

|                    |  |                 |                        |
|--------------------|--|-----------------|------------------------|
| <b>GEV No.</b>     | 560619   | <b>Ref. No.</b> | 12036104<br>RT51101327 |
| <b>description</b> | gasket L 76mm W 77mm CPC-Linie CM 61-202/G thickness 1mm |                 |                        |





door seals for dishwashers

Зип Общепит  
vsezip.ru  
+7(812)987-08-81

1



|                    |  |                 |          |
|--------------------|--|-----------------|----------|
| <b>GEV No.</b>     | 518215   | <b>Ref. No.</b> | 12021374 |
| <b>description</b> | door seal L 590mm W 26mm H 6mm silicone FAGOR suitable for dishwasher  |                 |          |
| <b>For models:</b> | AD-45BBT, AD-48, AD-48B, AD-48BDD, AD-48C, AD-48D, AD-48DD, AD-48HY, AD-48W, AD-64, AD-64B, AD-64BBT, AD-64BDD, AD-64BTDD, AD-64C, AD-64CW, AD-64D, AD-64DD, AD-64HY, AD-72, AD-72W, EASY-500, EASY-500B, EASY-500DD, EASY-500HP, EASY-500HPWBDD, FI-30, FI-30AR, FI-30AR+DD, FI-30B, FI-30B-BT-UK, FI-30-UK, FI-48, FI-48AR, FI-48B, FI-48B-BT-UK, FI-48C, FI-48D, FI-48HY-CLINIC, FI-48W, FI-60DD, FI-64, FI-64AR, FI-64B, FI-64B-BT-UK, FI-64C, FI-64D, FI-64HY-CLINIC, FI-64W, FI-72...(Other models you can see in the webshop) |                 |          |

1



|                    |   |                 |                     |
|--------------------|---|-----------------|---------------------|
| <b>GEV No.</b>     | 505237  | <b>Ref. No.</b> | 12025277<br>Z400309 |
| <b>description</b> | foam rubber gasket W 8mm thickness 2mm self-adhesive Qty 450mm  |                 |                     |
| <b>For models:</b> | AD-15, AD-15D, LVC-12, LVC-15, LVC-15D, LVR-10, LVR-14, LVR-14D |                 |                     |

1



|                    |   |                 |                     |
|--------------------|---|-----------------|---------------------|
| <b>GEV No.</b>     | 505250  | <b>Ref. No.</b> | 12021459<br>Z680532 |
| <b>description</b> | foam rubber gasket W 20mm thickness 5mm Qty 720mm |                 |                     |
| <b>For models:</b> | ECO-1200, FI-1200, FI-900                         |                 |                     |

1



|                    |  |                 |                     |
|--------------------|--|-----------------|---------------------|
| <b>GEV No.</b>     | 505264   | <b>Ref. No.</b> | 12024174<br>Z200313 |
| <b>description</b> | foam rubber gasket W 9mm thickness 2.5mm self-adhesive Qty 625mm   |                 |                     |
| <b>For models:</b> | AD-45BBT, AD-48, AD-48B, AD-48BDD, AD-48C, AD-48D, AD-48DD, AD-48HY, AD-48W, AD-64, AD-64B, AD-64BBT, AD-64BDD, AD-64BTDD, AD-64C, AD-64CW, AD-64D, AD-64DD, AD-64HY, AD-72, AD-72W, EASY-500, EASY-500B, EASY-500DD, EASY-500HP, EASY-500HPWBDD, FI-30, FI-30AR, FI-30AR+DD, FI-30B, FI-30B-BT-UK, FI-30-UK, FI-48, FI-48AR, FI-48B, FI-48B-BT-UK, FI-48C, FI-48D, FI-48HY-CLINIC, FI-48W, FI-50, FI-60DD, FI-64, FI-64AR, FI-64B, FI-64B-BT-UK, FI-64C, FI-64D, FI-64HY-CLINIC, FI-64W...(Other models you can see in the webshop) |                 |                     |

1



|                    |   |                 |                     |
|--------------------|---|-----------------|---------------------|
| <b>GEV No.</b>     | 505248  | <b>Ref. No.</b> | 12023929<br>Z950318 |
| <b>description</b> | foam rubber gasket W 21mm thickness 1.5mm self-adhesive Qty 350mm |                 |                     |
| <b>For models:</b> | GA-20, GA-20D, GA-40, GA-40D                                      |                 |                     |

sealing discs

1



|                    |   |                 |                     |
|--------------------|---|-----------------|---------------------|
| <b>GEV No.</b>     | 109066  | <b>Ref. No.</b> | 12009984<br>Q306051 |
| <b>description</b> | flat gasket ø 23mm thickness 3mm fibre Qty 1 pcs  |                 |                     |
| <b>For models:</b> | BG7-05, BG7-05I, BG7-10, BG7-10I, BG9-05, BG9-05AD, BG9-05I, BG9-05PF, BG9-05PI, BG9-05PLUS-I, BG9-10, BG9-10AD, BG9-10I, BG9-10PF, BG9-10PI, BG9-10PLUS-I, BMG7-10, BMG9-05, BMG9-05V-T, BMG9-10, BMG9-10V-T, CG-210, CG-210G, CG7-10, CG7-20, CG7-20H, CG7-30D, CG7-30I, CG7-40, CG7-40H, CG7-50, CG7-60, CG7-60H, CG9-05AD, CG9-05PLUS, CG9-10, CG9-10AD, CG9-10PLUS, CG9-20, CG9-40, CG9-60, CGB7-61, CGE7-41, CGE7-41H, CGF9-120D, CGF9-120D-AD, CGF9-120I, CGF9-120I-AD, CGF9-120PLUS-D, CGF9-120PLUS-I...(Other models you can see in the webshop) |                 |                     |

miscellaneous

Зип Общежит

vsezip.ru

+7(812)987-08-81



1

|                    |   |                 |                        |
|--------------------|---|-----------------|------------------------|
| <b>GEV No.</b>     | 900870  | <b>Ref. No.</b> | 12037063<br>V107170001 |
| <b>description</b> | door seal for glass door L 770mm plug-in gasket |                 |                        |
| <b>For models:</b> | VM-100-I, VM-100-M, VM-135-I, VM-135-M          |                 |                        |

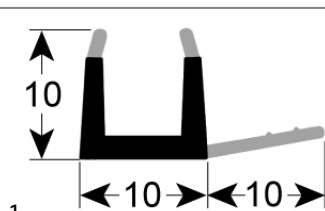

1

|                    |                                      |                 |                        |
|--------------------|--------------------------------------|-----------------|------------------------|
| <b>GEV No.</b>     | 900874                               | <b>Ref. No.</b> | 12037220<br>S107170001 |
| <b>description</b> | door seal L 575mm external weith 5mm |                 |                        |



1

|                    |   |                 |                     |
|--------------------|---|-----------------|---------------------|
| <b>GEV No.</b>     | 505078  | <b>Ref. No.</b> | 12024556<br>Z200907 |
| <b>description</b> | gasket external hight 23.5mm for sump ED ø 225mm ID ø 200mm   |                 |                     |
| <b>For models:</b> | AD-45BBT, AD-48, AD-48B, AD-48BDD, AD-48C, AD-48D, AD-48DD, AD-48HY, AD-48W, AD-64, AD-64B, AD-64BBT, AD-64BDD, AD-64BTDD, AD-64C, AD-64CW, AD-64D, AD-64DD, AD-64HY, AD-72, AD-72W, EASY-500, EASY-500B, EASY-500DD, EASY-500HP, FI-30, FI-30AR, FI-30AR+DD, FI-30B, FI-30B-BT-UK, FI-30-UK, FI-48, FI-48AR, FI-48B, FI-48B-BT-UK, FI-48C, FI-48D, FI-48HY-CLINIC, FI-48W, FI-50, FI-60DD, FI-64, FI-64AR, FI-64B, FI-64B-BT-UK, FI-64C, FI-64D, FI-64HY-CLINIC, FI-64W, FI-72...(Other models you can see in the webshop) |                 |                     |



1

|                    |  |                 |                     |
|--------------------|--|-----------------|---------------------|
| <b>GEV No.</b>     | 505077   | <b>Ref. No.</b> | 12024113<br>Z400902 |
| <b>description</b> | gasket external hight 23mm for sump  |                 |                     |
| <b>For models:</b> | AD-15, AD-15D, AD-20C-UK, AD-21, AD-21B, AD-21BDD, AD-21C, AD-21D, AD-21DD, AD-21W, CO-350, CO-350-B, CO-350-B-DD, CO-350-COLD, CO-350-COLD-B, CO-350-COLD-B-DD, CO-350-COLD-DD, CO-350-DD, CO-352-COLD, CO-352-COLD-B, CO-352-COLD-B-DD, CO-352-COLD-DD, CO-400, CO-400-B, CO-400-B-DD, CO-400-COLD, CO-400-COLD-B, CO-400-COLD-B-DD, CO-400-COLD-DD, CO-400-DD, CO-400-SOFT, CO-402-COLD, CO-402-COLD-B, CO-402-COLD-B-DD, CO-402-COLD-DD, CO-402W, LVC-12, LVC-15, LVC-15D, LVC-21, LVC-21B, LVC-21C, LVC-21D, LVC-21W, LVR-10, LVR-14, LVR-14D, LVR-20, LVR-20B, LVR-20D...(Other models you can see in the webshop) |                 |                     |



1

|                    |   |                 |                     |
|--------------------|---|-----------------|---------------------|
| <b>GEV No.</b>     | 691087  | <b>Ref. No.</b> | 12039997<br>R012623 |
| <b>description</b> | gasket suitable for FAGOR equiv. no. R012623 L 20mm silicone  |                 |                     |
| <b>For models:</b> | HCG-10-11, HCG-10-21, HCG-2-10-11, HCG-6-11, HME-10-11, HME-10-21, HME-20-11, HME-20-21, HME-2-10-11, HME-6-11, HMG-10-11, HMG-10-11UL, HMG-10-21, HMG-10-21UL, HMG-2-10-11, HMG-6-11, HMI-10-11, HMI-10-11UL, HMI-10-21, HMI-10-21UL, HMI-2-10-11, HMI-6-11, HMI-6-11UL, HMM-10-11, HMM-10-11UL, HMM-10-21, HMM-10-21UL, HMM-20-11, HMM-20-11UL, HMM-20-21, HMM-2-10-11, HMM-40-11-USMC, HMM-6-11, HMM-6-11UL, HMP-10-11, HMP-10-21, HMP-20-11, HMP-20-21, HMP-2-10-11, HMP-6-11 |                 |                     |



1

|                    |  |                 |                     |
|--------------------|--|-----------------|---------------------|
| <b>GEV No.</b>     | 511992   | <b>Ref. No.</b> | 12023517<br>Z710547 |
| <b>description</b> | gasket suitable for FAGOR for hood mechanics L 100mm W 86mm thickness 2mm hole distance 30/45mm  |                 |                     |
| <b>For models:</b> | AD-120, AD-120B, AD-120BBTDD-UK, AD-120C, AD-120CW, AD-120HY, AD-90, AD-90BA, AD-90BBT, AD-90BDD, AD-90DD, ADE-120, ADE-120B, ECO-120, ECO-120B, FI-100, FI-100AR, FI-100B, FI-100BBT-UK, FI-120, FI-120AR+DD, FI-120B, FI-120C, FI-120HY-CLINIC, FI-120W, FI-80, FI-80AR, FI-80BBT-UK, FI-80W, FI-E-100, LABP-1000, LABP-1200, LABP-800, MF-120 |                 |                     |



Зип Общепит

vsezip.ru

+7(812)987-08-81

|   |   |                 |                        |
|---|---|-----------------|------------------------|
|  |   |                 |                        |
| 1   |   |                 |                        |
| <b>GEV No.</b>  | 550895  | <b>Ref. No.</b> | 12035290<br>RT51101308 |
| <b>description</b>  | gasket suitable for RATIONAL equiv. no. 51101308 L 179mm W 90mm electrode thickness 3mm |                 |                        |

|  |   |                 |                     |
|--|---|-----------------|---------------------|
|  |   |                 |                     |
| 1  |   |                 |                     |
| <b>GEV No.</b>   | 505179  | <b>Ref. No.</b> | 12024227<br>Z710714 |
| <b>description</b>   | gasket D1 ø 82.5mm D2 ø 44mm thickness 2.5mm with 4 screw holes wash arm support equiv. no. Z710714 suitable for FAGOR  |                 |                     |
| <b>For models:</b>   | AD-120, AD-120B, AD-120BBTDD-UK, AD-120C, AD-120CW, AD-120HY, AD-90, AD-90BA, AD-90BBT, AD-90BDD, AD-90DD, ADE-120, ADE-120B, ECO-120, ECO-120B, ECO-160, ECO-160D, ECO-160I, ECO-200, ECO-200D, ECO-200H, ECO-200HD, ECO-200HI, ECO-200I, FI-100, FI-100AR, FI-100B, FI-100BBT-UK, FI-120, FI-120AR+DD, FI-120B, FI-120C, FI-120HY-CLINIC, FI-120W, FI-160, FI-160D, FI-160I, FI-200, FI-200D, FI-200H, FI-200HD, FI-200HI, FI-200I, FI-200W, FI-80, FI-80AR, FI-80BBT-UK, FI-80W, FI-E-100, LABP-1000...(Other models you can see in the webshop) |                 |                     |

thermostat gaskets

|   |  |                 |                     |
|---|--|-----------------|---------------------|
|  |  |                 |                     |
| 1   |  |                 |                     |
| <b>GEV No.</b>  | 505093   | <b>Ref. No.</b> | 12024049<br>N503017 |
| <b>description</b>  | gasket for thermostat ED ø 35mm ID ø 24mm thickness 7mm equiv. no. N503017   |                 |                     |
| <b>For models:</b>  | AD-120, AD-120B, AD-120BBTDD-UK, AD-120C, AD-120CW, AD-120HY, AD-15, AD-15D, AD-20C-UK, AD-21, AD-21B, AD-21BDD, AD-21C, AD-21D, AD-21DD, AD-21W, AD-45BBT, AD-48, AD-48B, AD-48BDD, AD-48C, AD-48D, AD-48DD, AD-48HY, AD-48W, AD-64, AD-64B, AD-64BBT, AD-64BDD, AD-64BTDD, AD-64C, AD-64CW, AD-64D, AD-64DD, AD-64HY, AD-72, AD-72W, AD-90, AD-90BA, AD-90BBT, AD-90BDD, AD-90DD, ADE-120, ADE-120B, BME7-05, BME7-10, BME9-05, BME9-10, EASY-500, EASY-500B...(Other models you can see in the webshop) |                 |                     |

gaskets for wash arm support

|   |  |                 |                     |
|---|--|-----------------|---------------------|
|  |  |                 |                     |
| 1   |  |                 |                     |
| <b>GEV No.</b>  | 505167   | <b>Ref. No.</b> | 12023533<br>Z400703 |
| <b>description</b>  | gasket D1 ø 68mm D2 ø 35mm thickness 3.5mm with 4 screw holes equiv. no. Z400703 suitable for FAGOR  |                 |                     |
| <b>For models:</b>  | AD-15, AD-15D, AD-20C-UK, AD-21, AD-21B, AD-21BDD, AD-21C, AD-21D, AD-21DD, AD-21W, CO-350, CO-350-B, CO-350-B-DD, CO-350-COLD, CO-350-COLD-B, CO-350-COLD-B-DD, CO-350-COLD-DD, CO-350-DD, CO-352-COLD, CO-352-COLD-B, CO-352-COLD-B-DD, CO-352-COLD-DD, CO-400, CO-400-B, CO-400-B-DD, CO-400-COLD, CO-400-COLD-B, CO-400-COLD-B-DD, CO-400-COLD-DD, CO-400-DD, CO-400-SOFT, CO-402-COLD, CO-402-COLD-B, CO-402-COLD-B-DD, CO-402-COLD-DD, CO-402W, LVC-12, LVC-15, LVC-15D, LVC-21, LVC-21B, LVC-21C, LVC-21D, LVC-21W, LVR-10, LVR-14, LVR-14D, LVR-20, LVR-20B, LVR-20D...(Other models you can see in the webshop) |                 |                     |

refrigeration cycle components

valves

Schrader valves

valve bodies

|   |   |                 |                        |
|---|---|-----------------|------------------------|
|  |   |                 |                        |
| 1   |   |                 |                        |
| <b>GEV No.</b>  | 750097  | <b>Ref. No.</b> | 12037574<br>BR00014007 |
| <b>description</b>  | valve body for Schrader valve thread 1/4" SAE connection 6mm soldering connection |                 |                        |

filter driers

miscellaneous

|  |  |                 |  |
|--|--|-----------------|--|
|  |  |                 |  |
| 1  |  |                 |  |
| <b>GEV No.</b>   | 750119   | <b>Ref. No.</b> | 12036253<br>12036970<br>12048655<br>6000601003<br>6047010003 |
| <b>description</b>   | dryer size 40g ø 24mm L 167mm connection 6,3/6,3mm   |                 |  |
| <b>For models:</b>   | AEP-1402, AEP-1403, AEP-1404, AEP-1602, AEP-1603, AEP-1604, AEP-701, AEP-702, AEP-801, AEP-802, AFN-1402, AFN-1403, AFN-1404, AFN-1602, AFN-1603, AFN-1604, AFN-701, AFN-702, AFN-801, AFN-802, AFP-1402, AFP-1402-FORZ, AFP-1402-MIX, AFP-1403, AFP-1403-C, AFP-1403-FORZ, AFP-1403-P, AFP-1404, AFP-1404-C, AFP-1404-FORZ, AFP-1404-P, AFP-1602, AFP-1602-2, AFP-1603, AFP-1604, AFP-2103, AFP-2104, AFP-2104-C, AFP-2104-P, AFP-2105, AFP-2105-C, AFP-2105-P, AFP-2106, AFP-2106-C, AFP-2106-P, AFP-701, AFP-701-FORZ, AFP-702, AFP-702-C, AFP-702-FORZ...(Other models you can see in the webshop) |                 |  |

refrigeration pipes

capillary pipes



1

|                    |   |                 |                        |
|--------------------|---|-----------------|------------------------|
| <b>GEV No.</b>     | 694200  | <b>Ref. No.</b> | 12037191<br>M107020002 |
| <b>description</b> | capillary pipe ED ø 2.4mm ID ø 1.25mm L 1300mm copper |                 |                        |
| <b>For models:</b> | MEP-180, MPZ1-200                                     |                 |                        |

Зип Общепит

vsezip.ru

+7(812)987-08-81



1

|                    |  |                 |                        |
|--------------------|--|-----------------|------------------------|
| <b>GEV No.</b>     | 694203   | <b>Ref. No.</b> | 12037496<br>M107020001 |
| <b>description</b> | capillary pipe ED ø 2mm ID ø 1mm L 3300mm copper   |                 |                        |
| <b>For models:</b> | BFP-200, FMP-150, FMP-202, FMP-255, FMP-307, MCP-135, MCP-135-AD, MCP-180, MCP-180-AD, MCP-225, MEP-100, MEP-100G, MEP-135, MEP-180, MFP-135, MFP-135-2C, MFP-135-4C, MFP-135-AD, MFP-135-AD-2C, MFP-135-AD-4C, MFP-135-AD-PC, MFP-135-B, MFP-135-F, MFP-180, MFP-180-2C, MFP-180-4C, MFP-180-6C, MFP-180-AD, MFP-180-AD-2C, MFP-180-AD-4C, MFP-180-AD-6C, MFP-180-AD-PC, MFP-180-B, MFP-180-F, MFP-225, MFP-225-2C, MFP-225-4C, MFP-225-6C, MFP-225-8C, MFP-225-B, MFP-225-F, MFP-270-B, MFPG-135-AD, MFPG-180-AD, MMZ-150, MMZ-202, MPN-150-C, MPN-202-C, MPP-150, MPP-150-C...(Other models you can see in the webshop) |                 |                        |

heating tubes



1

|                    |   |                 |                        |
|--------------------|---|-----------------|------------------------|
| <b>GEV No.</b>     | 694201  | <b>Ref. No.</b> | 12035797<br>M107020004 |
| <b>description</b> | capillary pipe ED ø 2.4mm ID ø 1.25mm L 3500mm copper |                 |                        |
| <b>For models:</b> | MPN-150   |                 |                        |



1

|                    |   |                 |          |
|--------------------|---|-----------------|----------|
| <b>GEV No.</b>     | 701656  | <b>Ref. No.</b> | 12050455 |
| <b>description</b> | heater ED ø 8mm ID ø 6mm copper Qty 1 for refrigerated counters FAGOR MSN-MFN |                 |          |



evaporators

for fridges

producer-specific

Зип Общепит

vsezip.ru

+7(812)987-08-81

mechanical components, equipment accessories

1



1

|                    |  |                 |                        |
|--------------------|--|-----------------|------------------------|
| <b>GEV No.</b>     | 750205   | <b>Ref. No.</b> | 12032903<br>6029020002 |
| <b>description</b> | condenser L 330mm W 103mm H 265mm  |                 |                        |
| <b>For models:</b> | AEP-701, AEP-801, AEP-802, AF-1402-MIX, AF-1602-MIX, AF-1603-C, AF-1603-P, AF-1604-C, AF-1604-P, AF-802-C, AF-802-P, AFP-1602, AFP-1602-2, AFP-1603, AFP-1603-2, AFP-701, AFP-702, AFP-801, AFP-802, AFP-802-2C, AFP-802-3C, BFP-150, BFP-150A, BFP-150I, BFP-200, BFP-200A, BFP-200I, CAEP-701, CAEP-801, CAEP-802, CAF-1402MIXT, CAF-1602MIX, CAF-802-C, CAF-802-P, CAFP-1602-2, CAFP-1603-2, CAFP-701, CAFP-702, CAFP-801, CAFP-802, CAFP-802-2C, CAFP-802-3C, CFMP-150, CFMP-150F, CFMP-150PC, CFMP-150TV, CFMP-202, CFMP-202F, CFMP-202PC, CFMP-202TV...(Other models you can see in the webshop) |                 |                        |



Image not available

2

|                    |   |                 |  |
|--------------------|---|-----------------|--|
| <b>GEV No.</b>     | 750719  | <b>Ref. No.</b> | 12030681<br>6001902002<br>6029010005<br>M129010004 |
| <b>description</b> | evaporator L 330mm D 90mm H 205mm total length 450mm overall width 90mm overall height 205mm suitable for FAGOR   |                 |  |
| <b>For models:</b> | AEP-801, AEP-802, AFP-1602-2, AFP-701-FORZ, AFP-702-FORZ, AFP-801, AFP-802, FMP-117-R, FMP-150, FMP-169-R, FMP-200, FMP-202, FMP-222-R, FMP-250, FMP-255, FMP-274-R, FMP-300, FMP-307, MCN-237-R, MCP-237-GN-R, MCP-270-GN, MFN-237-R, MFP-225-4C, MFP-225-6C, MFP-225-8C, MFP-237-10C, MFP-237-2C, MFP-237-4C, MFP-237-6C, MFP-237-8C, MFP-237-GN-R, MFP-270-10C, MFP-270-2C, MFP-270-4C, MFP-270-6C, MFP-270-8C, MFP-270-F, MFP-270-GN, MPP-222-R, MPP-222-R-C, MPP-255, MPP-255-C, MPP-274-R, MPP-274-R-C, MPP-307, MPP-307-C, MSP-117-R, MSP-200-F, MSP-250, MSP-250-2C...(Other models you can see in the webshop) |                 |  |



1

|                    |   |                 |                        |
|--------------------|---|-----------------|------------------------|
| <b>GEV No.</b>     | 750399  | <b>Ref. No.</b> | 12031900<br>6029010140 |
| <b>description</b> | evaporator L 330mm W 125mm H 90mm total length 535mm overall width 130mm overall height 93mm connection 12mm suitable for FAGOR |                 |                        |
| <b>For models:</b> | CMPZ1-180, MEP-180, MEP-180-GN, MPZ1-180, MPZ1-200, MPZ1-225, MPZ1-250  |                 |                        |



1

|                    |   |                 |                        |
|--------------------|---|-----------------|------------------------|
| <b>GEV No.</b>     | 750688  | <b>Ref. No.</b> | 12031794<br>6029010146 |
| <b>description</b> | evaporator L 380mm W 95mm H 380mm H2 650mm  |                 |                        |
| <b>For models:</b> | AEP-701, AEP-801, AEP-802, AF-1402-MIX, AF-1602-MIX, AFP-1602, AFP-1602-2, AFP-1603, AFP-1603-2, AFP-701, AFP-702, AFP-801, AFP-802, AFP-802-2C, AFP-802-3C, APP-701, CAEP-801, CAEP-802, CAF-1602MIX, CAFP-1602-2, CAFP-1603-2, CAFP-801, CAFP-802, CAFP-802-2C, CAFP-802-3C, CAPP-701 |                 |                        |



1

|                    |  |                 |  |
|--------------------|--|-----------------|--|
| <b>GEV No.</b>     | 750299   | <b>Ref. No.</b> | 12030888<br>12031493<br>12031626<br>6029010034<br>6029010042<br>A129010010 |
| <b>description</b> | evaporator L 432mm W 90mm H 133mm suitable for FAGOR   |                 |  |
| <b>For models:</b> | AEP-701, AF-1402-MIX, AF-702-C, AF-702-P, AF-802-C, AF-802-P, AFP-701, AFP-702, AFP-802, AFP-802-2 |                 |  |



1

|                    |  |                 |  |
|--------------------|--|-----------------|--|
| <b>GEV No.</b>     | 750206   | <b>Ref. No.</b> | 12030388<br>12030606<br>6029010011<br>6029010040<br>A129010008 |
| <b>description</b> | evaporator L 440mm W 210mm H 90mm  |                 |  |
| <b>For models:</b> | AEP-801, AEP-802, AF-1602-MIX, AF-802-C, AFP-1602, AFP-1602-2, AFP-1603, AFP-1603-2, AFP-801, AFP-802, AFP-802-2 |                 |  |



1

|                    |                                   |                 |  |
|--------------------|-----------------------------------|-----------------|--|
| <b>GEV No.</b>     | 750260                            | <b>Ref. No.</b> | 12031290<br>12031386<br>12031866<br>6001902006<br>6029010013<br>M129010007 |
| <b>description</b> | evaporator L 460mm W 65mm H 150mm |                 |  |
| <b>For models:</b> | MEP-100, MEP-100G                 |                 |  |

Зип Общепит

vsezip.ru

+7(812)987-08-81



1

|                    |   |                 |  |
|--------------------|---|-----------------|--|
| <b>GEV No.</b>     | 750208  | <b>Ref. No.</b> | 12029094<br>12030075<br>12030785<br>6001901005<br>6029010010<br>A129010003 |
| <b>description</b> | evaporator L 500mm W 300mm H 170mm  |                 |  |
| <b>For models:</b> | AEP-701, AFP-1402-MIX, AFP-701, AFP-701-FORZ, AFP-702, AFP-702-C, AFP-702-FORZ, AFP-702-P |                 |  |



1

|                    |  |                 |  |
|--------------------|--|-----------------|--|
| <b>GEV No.</b>     | 750444   | <b>Ref. No.</b> | 12042017<br>12044960<br>6029010036<br>6029010148 |
| <b>description</b> | evaporator L 565mm W 125mm H 405mm mounting distance 1 650mm suitable for FAGOR  |                 |  |
| <b>For models:</b> | AEP-1402, AEP-1602, AF-1402-MIX, AF-1403-C, AF-1403-P, AF-1404-C, AF-1404-P, AF-1603-C, AF-1603-P, AF-1604-C, AF-1604-P, AF-2104-C, AF-2105-C, AF-2106-C, AF-702-C, AF-802-C, AFN-702, AFP-1402, AFP-1403, AFP-1404, AFP-1602, AFP-1602-2, AFP-1603, AFP-1604, AP-701, APP-701 |                 |  |



1

|                    |   |                 |  |
|--------------------|---|-----------------|--|
| <b>GEV No.</b>     | 750642  | <b>Ref. No.</b> | 12030276<br>12030449<br>6029010039<br>A129010007 |
| <b>description</b> | evaporator L 515mm W 108mm H 497mm mounting distance 1 437mm suitable for FAGOR   |                 |  |
| <b>For models:</b> | AEP-1402, AEP-1602, AF-1403-C, AF-1403-P, AF-1404-C, AF-1404-P, AF-1603-C, AF-1603-P, AF-1604-C, AF-1604-P, AFP-1402, AFP-1403, AFP-1404, AFP-1404-USMC, AFP-1602, AFP-1602-2, AFP-1603, AFP-1603-2, AFP-1604 |                 |  |



1

|                    |  |                 |  |
|--------------------|--|-----------------|--|
| <b>GEV No.</b>     | 750258   | <b>Ref. No.</b> | 12028920<br>12028921<br>12029453<br>6029010032<br>6029010035<br>A129010004 |
| <b>description</b> | evaporator L 660mm W 120mm H 385mm H2 165mm  |                 |  |
| <b>For models:</b> | AEP-2103, AF-2104-C, AF-2104-P, AF-2105-C, AF-2105-P, AF-2106-C, AF-2106-P, AFN-1402, AFN-1403, AFN-1404, AFN-1602, AFN-1603, AFN-1604, AFP-2103, AFP-2104, AFP-2105, AFP-2106 |                 |  |



1

|                    |   |                 |                        |
|--------------------|---|-----------------|------------------------|
| <b>GEV No.</b>     | 750207  | <b>Ref. No.</b> | 12031339<br>6029010088 |
| <b>description</b> | evaporator L 520mm W 65mm H 170mm   |                 |                        |
| <b>For models:</b> | FMP-117-R, FMP-150, FMP-169-R, FMP-200, MCP-135-GN, MCP-147-GN-R, MCP-180-GN, MFP-102-GN-R, MFP-135-B-GN, MFP-135-F-GN, MFP-135-GN, MFP-147-GN-R, MFP-180-B-GN, MFP-180-F-GN, MFP-180-GN, MFP-192-GN-R, MSP-117-2RC, MSP-117-4RC, MSP-117-R, MSP-150, MSP-150-2C, MSP-150-4C, MSP-150-F, MSP-150-GI, MSP-169-R, MSP-169-R2C, MSP-169-R4C, MSP-169-R6C, MSP-200, MSP-200-2C, MSP-200-4C, MSP-200-6C, MSP-200-F, MSP-200-GI |                 |                        |



1

|                    |   |                 |                        |
|--------------------|---|-----------------|------------------------|
| <b>GEV No.</b>     | 750259                                      | <b>Ref. No.</b> | 12028458<br>6001903002 |
| <b>description</b> | evaporator L 660mm W 120mm H 385mm H2 165mm |                 |                        |
| <b>For models:</b> | AFN-1402, AFN-1403, AFN-1404                |                 |                        |



Зип-Общепит

accessories

housings

vsezip.ru

+7(812)987-08-81



1

|   |  |                 |                        |
|---|--|-----------------|------------------------|
| <b>GEV No.</b>  | 750727   | <b>Ref. No.</b> | 12083695<br>A171010137 |
| <b>description</b>  | evaporator total length 370mm overall width 250mm overall height 230mm complete  |                 |                        |
| <b>For models:</b>  | AEP-1602AD, AEP-1603AD, AEP-1604AD, APF-1602AD, APF-1603AD, APF-1604AD, CPAEP-1602, CPAFP-1602   |                 |                        |
| <b>spare parts for</b>  | 750727   |                 |                        |
|  | <b>GEV No.</b>   | 601020          | <b>Ref. No.</b> —      |
|   | fan motor 5W 230V 50-60Hz L1 44mm L2 48mm L3 79mm W 84mm cable length 500mm 1300rpm YZF5-13-18/26 5 mounting options bearing slide bearing |                 |                        |
|  | <b>GEV No.</b>   | 601070          | <b>Ref. No.</b> —      |
|   | fan wheel sucking ø 200mm fan wheel mounting 25.4mm blade angle 28° W 38mm aluminium   |                 |                        |



1

|                    |   |                 |  |
|--------------------|---|-----------------|--|
| <b>GEV No.</b>     | 691847  | <b>Ref. No.</b> | 12033760<br>12034208<br>12034209<br>12034210<br>6000201012<br>6003050001<br>6003060001<br>6009992010 |
| <b>description</b> | sump for evaporator L 455mm W 515mm H 98mm  |                 |  |
| <b>For models:</b> | MCN-102-R, MCN-135, MCN-147-R, MCN-180, MCN-192-R, MCN-225, MCN-237-R, MCN-270, MCP-102-GN-R, MCP-135, MCP-135-GN, MCP-147-GN-R, MCP-180, MCP-180-GN, MCP-192-GN-R, MCP-225, MCP-225-GN, MCP-237-GN-R, MCP-270-GN, MFN-102-R, MFN-135, MFN-147-R, MFN-180, MFN-192-R, MFN-225, MFN-237-R, MFN-270, MFP-102-2C, MFP-102-4C, MFP-102-GN-R, MFP-135, MFP-135-2C, MFP-135-4C, MFP-135-F, MFP-135-GN, MFP-147-2C, MFP-147-4C, MFP-147-6C, MFP-147-GN-R, MFP-180, MFP-180-2C, MFP-180-4C, MFP-180-6C, MFP-180-F, MFP-180-GN, MFP-192-2C, MFP-192-4C, MFP-192-6C, MFP-192-8C, MFP-192-GN-R...(Other models you can see in the webshop) |                 |  |

for saladettes



1

|                    |   |                 |  |
|--------------------|---|-----------------|--|
| <b>GEV No.</b>     | 750614  | <b>Ref. No.</b> | 12031326<br>12031771<br>6029010015<br>M129010009 |
| <b>description</b> | evaporator L 385mm W 130mm D 90mm H 90mm total length 540mm overall width 130mm overall height 90mm mounting distance 1 530mm mounting distance 2 420mm |                 |  |
| <b>For models:</b> | MEP-135, MEP-180, MPZ1-150, MPZ1-200  |                 |  |



1

|                    |  |                 |                        |
|--------------------|--|-----------------|------------------------|
| <b>GEV No.</b>     | 692160   | <b>Ref. No.</b> | 12033558<br>6003050037 |
| <b>description</b> | sump for evaporator L 525mm W 450mm H 98mm   |                 |                        |
| <b>For models:</b> | MFP-102-GN-R, MFP-135-B, MFP-135-B-GN, MFP-135-F-GN, MFP-135-GN, MFP-147-GN-R, MFP-180-B, MFP-180-B-GN, MFP-180-F-GN, MFP-180-GN, MFP-192-GN-R, MFP-225-B, MFP-225-F-GN, MFP-225-GN, MFP-237-GN-R, MFP-270-B, MFP-270-F-GN, MFP-270-GN |                 |                        |

for ice-cube maker

for ice cube maker



1

|                    |   |                 |                        |
|--------------------|---|-----------------|------------------------|
| <b>GEV No.</b>     | 750201  | <b>Ref. No.</b> | 12028613<br>BR00D10046 |
| <b>description</b> | evaporator for ice-cube maker 36 cubes L 440mm W 190mm H 40mm |                 |                        |

condensors

condensors



1

|                    |   |                 |                        |
|--------------------|---|-----------------|------------------------|
| <b>GEV No.</b>     | 750661                                      | <b>Ref. No.</b> | 12029667<br>BR00020019 |
| <b>description</b> | condenser W 215mm D 270mm H 117mm Qty 1 pcs |                 |                        |

Зип Оффенит

vsezip.ru

+7(812)987-08-81

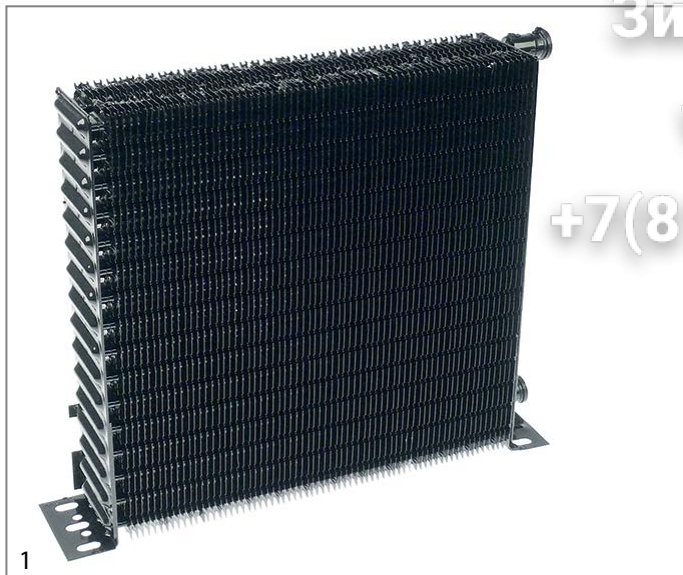

|                    |   |                 |          |
|--------------------|---|-----------------|----------|
| <b>GEV No.</b>     | 750409  | <b>Ref. No.</b> | 12029656 |
| <b>description</b> | condenser W 260mm D 60mm H 250mm mounting distance 275mm connection ø 8mm |                 |          |



|                    |                                   |                 |  |
|--------------------|-----------------------------------|-----------------|--|
| <b>GEV No.</b>     | 750029                            | <b>Ref. No.</b> | 12030455<br>12032340<br>6001911003<br>6029020003 |
| <b>description</b> | condenser W 320mm D 123mm H 265mm |                 |  |

**For models:** AEP-1402, AEP-1403, AEP-1404, AEP-1602, AEP-1603, AEP-1604, AF-1403-C, AF-1403-P, AF-1404-C, AF-1404-P, AF-1603-C, AF-1603-P, AF-1604-C, AF-1604-P, AFP-1402, AFP-1402-FORZ, AFP-1403, AFP-1403-C, AFP-1403-FORZ, AFP-1403-P, AFP-1404, AFP-1404-C, AFP-1404-FORZ, AFP-1404-P, AFP-1602, AFP-1602-2, AFP-1603, AFP-1604, AP-701, APP-701, BFP-100, BFP-150, BFP-200, BFP-250, BFP-250A, BFP-250I, BFP-300, BFP-300I, CAEP-1402, CAEP-1602, CAF-1403C, CAF-1403P, CAF-1404C, CAF-1404P, CAF-1603-C, CAF-1603-P, CAF-1604-C, CAF-1604-P, CAFP-1402, CAFP-1403...(Other models you can see in the webshop)

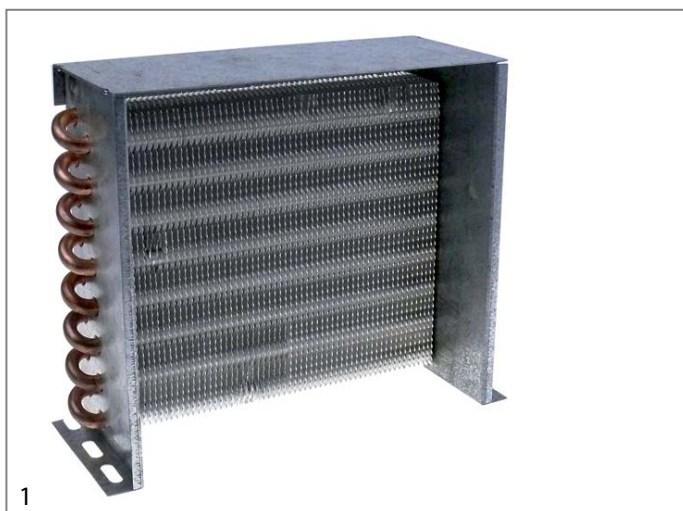

|                    |                                   |                 |  |
|--------------------|-----------------------------------|-----------------|--|
| <b>GEV No.</b>     | 750262                            | <b>Ref. No.</b> | 12031684<br>12033007<br>6001911008<br>6029020008 |
| <b>description</b> | condenser W 290mm D 100mm H 235mm |                 |  |

**For models:** AF-1403-P, AF-1404-P, AF-1603-P, AF-1604-P, AF-2104-P, AF-2105-P, AF-2106-P, AF-702-C, AF-702-P, AF-802-C, AF-802-P, AFP-802, AFP-802-2, BFP-150, CAF-1403P, CAF-1404P, CAF-1603-P, CAF-1604-P, CAF-2104C, CAF-2105C, CAF-2106C, CAF-702C, CAF-702P, CAF-802-C, CAF-802-P, CAFP-802-2, VM-100-I, VM-100-M, VM-135-I, VM-135-M



|                    |                                   |                 |  |
|--------------------|-----------------------------------|-----------------|--|
| <b>GEV No.</b>     | 750261                            | <b>Ref. No.</b> | 12029716<br>12031310<br>6001911005<br>6029020005 |
| <b>description</b> | condenser W 320mm D 130mm H 270mm |                 |  |

**For models:** AEP-2103, AEP-802, AF-1402-MIX, AF-1602-MIX, AF-1603-C, AF-1604-C, AF-2104-C, AF-2104-P, AF-2105-C, AF-2105-P, AF-2106-C, AF-2106-P, AFN-701, AFN-702, AFN-801, AFN-802, AFP-1402-MIX, AFP-2103, AFP-2104, AFP-2104-C, AFP-2104-P, AFP-2105, AFP-2105-C, AFP-2105-P, AFP-2106, AFP-2106-C, AFP-2106-P, CAEP-2103, CAF-1603-C, CAF-1604-C, CAF-2104C, CAF-2104P, CAF-2105C, CAF-2105P, CAF-2106C, CAF-2106P, CAFP-2103, CAFP-2104, CAFP-2105, CAFP-2106, CMFN-180, CMPN-202, CMSN-200, MCN-135, MCN-135-GN, MCN-180, MCN-180-GN, MCN-225-GN, MCN-270-GN, MFN-102-GN-R...(Other models you can see in the webshop)





## evaporation and condensing trays

### unheated condensing trays

|   |   |                 |  |
|---|---|-----------------|--|
|  |   |                 |  |
| 1   |   |                 |  |
| <b>GEV No.</b>  | 750067  | <b>Ref. No.</b> | 12018237<br>12036623<br>6000202204<br>6003010023 |
| <b>description</b>  | condensing tray L 255mm W 127mm H 70mm  |                 |  |
| <b>For models:</b>  | ADMFCN-135, ADMFCN-180, ADMFCN-225, ADMCP-135, ADMCP-180, ADMCP-225, ADMFN-135, ADMFN-180, ADMFN-225, ADMFP-135, ADMFP-135-GR, ADMFP-135HD, ADMFP-135HH, ADMFP-135PC, ADMFP-180, ADMFP-180-GR, ADMFP-180HDD, ADMFP-180HHD, ADMFP-180HHH, ADMFP-180PC, ADMFP-225, ADMFP-225-GR, ADMFP-225HDD, ADMFP-225HDD, ADMFP-225HHHD, ADMFP-225HHH, ADMFP-225PC, AEP-1402, AEP-1403, AEP-1404, AEP-2103, AEP-701, AEP-702, AF-1402-MIX, AF-1403-C, AF-1403-P, AF-1404-C, AF-1404-P, AF-2104-C, AF-2104-P, AF-2105-C, AF-2105-P, AF-2106-C, AF-2106-P, AF-702-C, AF-702-P, AFN-1402, AFN-1403, AFN-1404, AFN-701...(Other models you can see in the webshop) |                 |  |

### miscellaneous

|  |  |                 |  |
|--|--|-----------------|--|
|  |  |                 |  |
| 1  |  |                 |  |
| <b>GEV No.</b>   | 750281   | <b>Ref. No.</b> | 12033557<br>12033759<br>12101127<br>6003050002<br>6009992002 |
| <b>description</b>   | evaporation tray L 476mm W 427mm H 100mm   |                 |  |
| <b>For models:</b>   | FMP-117-R, FMP-150, FMP-169-R, FMP-200, FMP-202, FMP-222-R, FMP-255, FMP-274-R, FMP-307, MSN-117-R, MSN-150, MSN-169-R, MSN-200, MSN-222-R, MSN-250, MSN-274-R, MSN-300, MSP-117-2C, MSP-117-4C, MSP-117-R, MSP-150, MSP-150-2C, MSP-150-4C, MSP-150-F, MSP-169-2C, MSP-169-4C, MSP-169-6C, MSP-169-R, MSP-200, MSP-200-2C, MSP-200-4C, MSP-200-6C, MSP-200-F, MSP-222-2C, MSP-222-4C, MSP-222-6C, MSP-222-8C, MSP-222-R, MSP-250, MSP-250-2C, MSP-250-4C, MSP-250-6C, MSP-250-8C, MSP-250-F, MSP-274-10C, MSP-274-2C, MSP-274-4C, MSP-274-6C, MSP-274-8C, MSP-274-R...(Other models you can see in the webshop) |                 |  |

## transmission technology and ball bearings

### chains

#### roller chains 08B-1 single

|   |   |                 |                     |
|---|---|-----------------|---------------------|
|  |   |                 |                     |
| 1   |   |                 |                     |
| <b>GEV No.</b>  | 505339  | <b>Ref. No.</b> | 12025097<br>Z275008 |
| <b>description</b>  | roller chain DIN/ISO 08 B-1 splitting 1/2" / 12.7mm links 28 internal width 7.75mm rollerø 8.51mm   |                 |                     |
| <b>For models:</b>  | ECO-160, ECO-160D, ECO-160I, ECO-200, ECO-200D, ECO-200H, ECO-200HD, ECO-200HI, ECO-200I, ECO-2700D, ECO-2700I, ECO-280D, ECO-280I, ECO-370D, ECO-370I, ECO-4000D, ECO-4000I, ECO-460D, ECO-460I, ECO-550D, ECO-550I, ECO-6000D, ECO-6000I, FI-160, FI-160AR, FI-160D, FI-160I, FI-200, FI-200AR, FI-200D, FI-200H, FI-200HD, FI-200HI, FI-200I, FI-200WL, FI-200WR, FI-2700D, FI-2700I, FI-280D, FI-280I, FI-370D, FI-370I, FI-4000D, FI-4000I, FI-460D, FI-460I, FI-550D, FI-550I, FI-6000D...(Other models you can see in the webshop) |                 |                     |

## Зип Общепит

|  |  |                 |                     |
|--|--|-----------------|---------------------|
|  |  |                 |                     |
| 1  |  |                 |                     |
| <b>GEV No.</b>   | 693276   | <b>Ref. No.</b> | 12023767<br>Z105012 |
| <b>description</b>   | connector single DIN/ISO 08 B-1 splitting 1/2" links 1 L 23mm internal width 11.8mm rollerø 4.3mm metal  |                 |                     |
| <b>For models:</b>   | ECO-160, ECO-160D, ECO-160I, ECO-200, ECO-200D, ECO-200H, ECO-200HD, ECO-200HI, ECO-200I, ECO-2300, ECO-2700D, ECO-2700I, ECO-280D, ECO-280I, ECO-3000, ECO-370D, ECO-370I, ECO-4000D, ECO-4000I, ECO-460D, ECO-460I, ECO-550D, ECO-550I, ECO-6000D, ECO-6000I, FI-160, FI-160D, FI-160AR, FI-160D, FI-160I, FI-200, FI-200AR, FI-200D, FI-200H, FI-200HD, FI-200HI, FI-200I, FI-200WL, FI-200WR, FI-2300, FI-2700D, FI-2700I, FI-280D, FI-280I, FI-3000, FI-370D, FI-370I, FI-4000D...(Other models you can see in the webshop) |                 |                     |

## springs

### torsion springs

|  |   |                 |                     |
|--|---|-----------------|---------------------|
|  |   |                 |                     |
| 1  |   |                 |                     |
| <b>GEV No.</b>   | 692159  | <b>Ref. No.</b> | 12024390<br>Z271203 |
| <b>description</b>   | torsion spring ø 10.3mm L2 20mm wire gauge ø 1.4mm L1 2mm L3 33mm Qty 1 pcs   |                 |                     |
| <b>For models:</b>   | ECO-160, ECO-160D, ECO-160I, ECO-200, ECO-200D, ECO-200H, ECO-200HD, ECO-200HI, ECO-200I, ECO-280D, ECO-280I, ECO-370D, ECO-370I, ECO-460D, ECO-460I, ECO-550D, ECO-550I, FI-160, FI-160AR, FI-160D, FI-160I, FI-200, FI-200AR, FI-200D, FI-200H, FI-200HD, FI-200HI, FI-200I, FI-200WL, FI-200WR, FI-280D, FI-280I, FI-370D, FI-370I, FI-460D, FI-460I, FI-550D, FI-550I |                 |                     |

|  |   |                 |                     |
|--|---|-----------------|---------------------|
|  |   |                 |                     |
| 1  |   |                 |                     |
| <b>GEV No.</b>   | 691067  | <b>Ref. No.</b> | 12009262<br>S316110 |
| <b>description</b>   | torsion spring ø 28.2mm L2 107mm wire gauge ø 4mm L1 42mm |                 |                     |
| <b>For models:</b>   | ME7-10BM, MG7-10, MG7-10BM, MV7-10BM, SBE7-10, SBG7-10    |                 |                     |

|  |  |                 |          |
|--|--|-----------------|----------|
|  |  |                 |          |
| 1  |  |                 |          |
| <b>GEV No.</b>   | 692811   | <b>Ref. No.</b> | 12093685 |
| <b>description</b>   | torsion spring ø 34mm L2 6mm wire gauge ø 2mm L1 10mm L3 6mm Qty 1 pcs                                 |                 |          |
| <b>For models:</b>   | ACE-201, ACE-202, ACG-201, ACG-202, AE-201, AE-202, AG-201, AG-202, APE-201, APE-202, APG-201, APG-202 |                 |          |

Зип Общепит  
vsezip.ru  
77(812)987-08-81



|                    |  |                 |                      |
|--------------------|--|-----------------|----------------------|
| <b>GEV No.</b>     | 540855   | <b>Ref. No.</b> | 12032821<br>ICR08052 |
| <b>description</b> | torsion spring ø 50.8mm wire gauge ø 5.1mm L1 34mm L2 104mm L3 29mm mounting pos. left |                 |                      |



|                    |   |                 |                      |
|--------------------|---|-----------------|----------------------|
| <b>GEV No.</b>     | 514350  | <b>Ref. No.</b> | 12032817<br>ICR08055 |
| <b>description</b> | torsion spring ø 51mm wire gauge ø 6mm L1 28mm L2 95mm L3 28mm mounting pos. left |                 |                      |



|                    |   |                 |                      |
|--------------------|---|-----------------|----------------------|
| <b>GEV No.</b>     | 540854  | <b>Ref. No.</b> | 12032818<br>ICR08051 |
| <b>description</b> | torsion spring ø 50.8mm wire gauge ø 5.1mm L1 34mm L2 104mm L3 29mm mounting pos. right |                 |                      |



|                    |  |                 |                      |
|--------------------|--|-----------------|----------------------|
| <b>GEV No.</b>     | 514349   | <b>Ref. No.</b> | 12032814<br>ICR08054 |
| <b>description</b> | torsion spring ø 51mm wire gauge ø 6mm L1 28mm L2 95mm L3 28mm mounting pos. right |                 |                      |

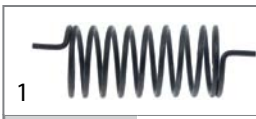

|                    |  |                 |                      |
|--------------------|--|-----------------|----------------------|
| <b>GEV No.</b>     | 514346   | <b>Ref. No.</b> | 12032819<br>ICR08008 |
| <b>description</b> | torsion spring ø 51.5mm wire gauge ø 4.1mm L1 21mm L2 110mm L3 21mm mounting pos. left |                 |                      |

compression springs



|                    |  |                 |                     |
|--------------------|--|-----------------|---------------------|
| <b>GEV No.</b>     | 505138   | <b>Ref. No.</b> | 12040429<br>Z600605 |
| <b>description</b> | compression spring   |                 |                     |
| <b>For models:</b> | FI-300B, FI-300R, FI-650R, FTG7-05, FTG7-10, FTG9-05L, FTG9-05R, FTG9-10L, FTG9-10L+R, FTG9-10R, FTGC9-05, FTGC9-10, LC-10, LC-14, LC-7, LC-7A |                 |                     |



|                    |   |                 |          |
|--------------------|---|-----------------|----------|
| <b>GEV No.</b>     | 514339  | <b>Ref. No.</b> | ICR08007 |
| <b>description</b> | torsion spring ø 51.8mm wire gauge ø 4.1mm L1 20mm L2 106mm L3 20mm mounting pos. right |                 |          |



|                    |  |                 |                     |
|--------------------|--|-----------------|---------------------|
| <b>GEV No.</b>     | 691008   | <b>Ref. No.</b> | 12025252<br>Z700603 |
| <b>description</b> | compression spring ø 10mm L 28mm wire gauge ø 0.9mm  |                 |                     |
| <b>For models:</b> | BG9-05PLUS-I, BG9-10PLUS-I, CE-15, CE-9, FE-710, FE-720, FE9-05, FE9-05S, FE9-05USMC, FE9-10, FI-300B, FI-300R, FI-650R, FTG9-05PLUS-CL, FTG9-05PLUS-CR, FTG9-05PLUS-L, FTG9-05PLUS-LV, FTG9-05PLUS-R, FTG9-05PLUS-RV, FTG9-10PLUS-CL, FTG9-10PLUS-CLR, FTG9-10PLUS-CR, FTG9-10PLUS-L, FTG9-10PLUS-LR, FTG9-10PLUS-LRV, FTG9-10PLUS-LV, FTG9-10PLUS-R, FTG9-10PLUS-RV, HCG-10-11, HCG-10-21, HCG-20-11, HCG-2-10-11, HCG-6-11, HME-10-11, HME-10-21, HME-20-11, HME-20-21, HME-2-10-11, HME-6-11, HMG-10-11, HMG-10-11UL, HMG-10-21, HMG-10-21UL, HMG-20-11, HMG-2-10-11, HMG-6-11, HMI-10-11, HMI-10-11UL, HMI-10-21, HMI-10-21UL...(Other models you can see in the webshop) |                 |                     |



|                    |  |                 |   |
|--------------------|--|-----------------|---|
| <b>GEV No.</b>     | 514352   | <b>Ref. No.</b> | 12032815<br>12033015<br>ICR08093<br>ICRI08093 |
| <b>description</b> | torsion spring ø 51mm wire gauge ø 6.5mm L1 28mm L2 101mm L3 28mm mounting pos. left |                 |   |



|                    |   |                 |   |
|--------------------|---|-----------------|---|
| <b>GEV No.</b>     | 514351  | <b>Ref. No.</b> | 12032816<br>12033014<br>ICR08083<br>ICRI08083 |
| <b>description</b> | torsion spring ø 51mm wire gauge ø 6.5mm L1 28mm L2 101mm L3 28mm mounting pos. right |                 |   |

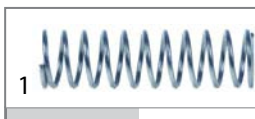

|                    |   |                 |                     |
|--------------------|---|-----------------|---------------------|
| <b>GEV No.</b>     | 691880  | <b>Ref. No.</b> | 12016846<br>R725007 |
| <b>description</b> | compression spring ø 13.3mm L 47.5mm wire gauge ø 1.2mm                                 |                 |                     |
| <b>For models:</b> | FF-35, HMG-10-11, HMG-10-11UL, HMG-10-21, HMG-10-21UL, HMG-20-11, HMG-2-10-11, HMG-6-11 |                 |                     |

|                    |   |                 |                     |
|--------------------|---|-----------------|---------------------|
| <b>GEV No.</b>     | 691876  | <b>Ref. No.</b> | 12024277<br>R725008 |
| <b>description</b> | compression spring $\varnothing$ 14.5mm L 20mm wire gauge $\varnothing$ 1.8mm   |                 |                     |
| <b>For models:</b> | HGP-10-21, HGP-20-21, HGV-10-11, HGV-10-21, HGV-20-11, HGV-20-21, HMG-10-11, HMG-10-21, HMG-2-10-11, HMG-6-11, HVG-10-11, HVG-10-11UL, HVG-10-21, HVG-10-21UL, HVG-20-11, HVG-20-21, HVG-2-10-11, HVG-2-20-21, MFHVG-10-11, MFHVG-10-21, VG-101, VG-102, VG-201, VG-202, VPG-101, VPG-102, VPG-201, VPG-202 |                 |                     |

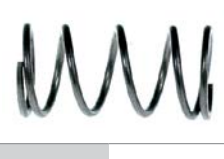

|                    |   |                 |                        |
|--------------------|---|-----------------|------------------------|
| <b>GEV No.</b>     | 693591  | <b>Ref. No.</b> | 12037536<br>RT20010109 |
| <b>description</b> | compression spring $\varnothing$ 14mm L 27mm wire gauge $\varnothing$ 1.5mm |                 |                        |

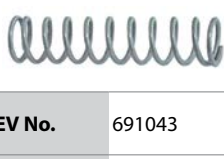

|                    |   |                 |                     |
|--------------------|---|-----------------|---------------------|
| <b>GEV No.</b>     | 691043  | <b>Ref. No.</b> | 12017094<br>R010511 |
| <b>description</b> | compression spring $\varnothing$ 16.1mm L 70mm wire gauge $\varnothing$ 1.8mm   |                 |                     |
| <b>For models:</b> | FE-920, FF-35, HCG-10-11, HCG-10-21, HCG-20-11, HCG-2-10-11, HCG-6-11, HCV-10-11, HCV-10-21, HCV-2-10-21, HCV-6-11, HE-10-11, HE-10-21, HE-2-10-11, HE-6-11, HG-10-11, HG-10-21, HG-2-10-11, HME-10-11, HME-10-21, HME-20-11, HME-20-21, HME-2-10-11, HME-6-11, HMG-10-11, HMG-10-11UL, HMG-10-21, HMG-10-21UL, HMG-20-11, HMG-2-10-11, HMG-6-11, HMI-10-11, HMI-10-11UL, HMI-10-21, HMI-10-21UL, HMI-2-10-11, HMI-6-11, HMI-6-11UL, HMM-10-11, HMM-10-11UL, HMM-10-21, HMM-10-21UL, HMM-20-11, HMM-20-11UL, HMM-20-21, HMM-2-10-11, HMM-6-11, HMM-6-11UL, HMP-10-11, HMP-10-21...(Other models you can see in the webshop) |                 |                     |



|                    |   |                 |                                |
|--------------------|---|-----------------|--------------------------------|
| <b>GEV No.</b>     | 691032  | <b>Ref. No.</b> | 12009265<br>S136080<br>S136108 |
| <b>description</b> | compression spring $\varnothing$ 42.6mm L 129mm wire gauge $\varnothing$ 7mm  |                 |                                |
| <b>For models:</b> | MPE9-10BM, MPE9-10BMS, MPE9-15BM, MPE9-15BMS, MPG9-10, MPG9-10BM, MPG9-10BMS, MPG9-10S, MPG9-15, MPG9-15BM, MPG9-15BMS, MPG9-15S, MPG9-20, MPG9-20S |                 |                                |

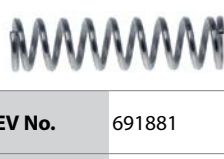

|                    |  |                 |                     |
|--------------------|--|-----------------|---------------------|
| <b>GEV No.</b>     | 691881   | <b>Ref. No.</b> | 12019099<br>Z850608 |
| <b>description</b> | compression spring $\varnothing$ 6mm L 24mm wire gauge $\varnothing$ 0.8mm |                 |                     |

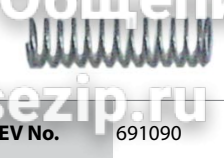

|                    |  |                 |                     |
|--------------------|--|-----------------|---------------------|
| <b>GEV No.</b>     | 691090   | <b>Ref. No.</b> | 12023716<br>Z850519 |
| <b>description</b> | compression spring $\varnothing$ 7.1mm L 25.5mm wire gauge $\varnothing$ 0.7mm   |                 |                     |
| <b>For models:</b> | ACE-061, ACE-101, ACE-102, ACE-201, ACE-202, ACG-061, ACG-101, ACG-102, ACG-201, ACG-202, AE-061, AE-061W, AE-101, AE-101W, AE-102, AE-102W, AE-201, AE-202, AG-061, AG-061W, AG-101, AG-101W, AG-102, AG-102W, AG-201, AG-202, APE-061, APE-061W, APE-101, APE-101W, APE-102, APE-102W, APE-201, APE-202, APG-061, APG-061W, APG-101, APG-101W, APG-102, APG-102W, APG-201, APG-202, COE-061, COE-101, COE-102, COE-201, COE-202, COG-061, COG-101, COG-102...(Other models you can see in the webshop) |                 |                     |

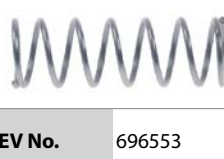

|                    |  |                 |                     |
|--------------------|--|-----------------|---------------------|
| <b>GEV No.</b>     | 696553   | <b>Ref. No.</b> | 12017801<br>Z883001 |
| <b>description</b> | compression spring $\varnothing$ 7.5mm L 23mm wire gauge $\varnothing$ 0.7mm   |                 |                     |
| <b>For models:</b> | ECO-280D, ECO-280I, ECO-370D, ECO-370I, ECO-460D, ECO-460I, ECO-550D, ECO-550I, FI-280D, FI-280I, FI-370D, FI-370I, FI-460D, FI-460I, FI-550D, FI-550I, HEI-10-11, HEI-20-11, HEI-6-11, HEM-10-11, HEM-20-11, HEM-6-11, HEP-10-11, HEP-20-11, HEP-6-11, HME-10-11, HME-20-11, HME-6-11, HMI-10-11, HMI-10-11UL, HMI-10-21, HMI-10-21UL, HMI-2-10-11, HMI-6-11, HMI-6-11UL, HMM-10-11, HMM-10-11UL, HMM-10-21, HMM-10-21UL, HMM-20-11, HMM-20-11UL, HMM-20-21, HMM-2-10-11, HMM-2-20-11, HMM-40-11-USMC...(Other models you can see in the webshop) |                 |                     |

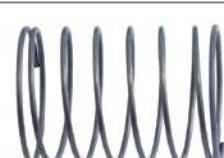

|                    |   |                 |                     |
|--------------------|---|-----------------|---------------------|
| <b>GEV No.</b>     | 691011  | <b>Ref. No.</b> | 12008888<br>S112105 |
| <b>description</b> | compression spring $\varnothing$ 70mm L 95mm wire gauge $\varnothing$ 3mm for drain tap   |                 |                     |
| <b>For models:</b> | FTE7-05, FTE7-10, FTE9-05L, FTE9-05R, FTE9-10L, FTE9-10L+R, FTE9-10R, FTEC9-05, FTEC9-05L, FTEC9-05R, FTEC9-10, FTEC9-10L, FTEC9-10L+R, FTEC9-10R, FTG7-05, FTG7-10, FTG-9050L, FTG-9050R, FTG9-05L, FTG9-05R, FTG9-05VL, FTG9-05VR, FTG-9100L, FTG-9100L+R, FTG-9100R, FTG9-10L, FTG9-10L+R, FTG9-10R, FTG9-10VL, FTG9-10VL+R, FTG9-10VR, FTGC9-05, FTGC-9050, FTGC9-05L, FTGC9-05R, FTGC9-10, FTGC-9100, FTGC9-10L, FTGC9-10L+R, FTGC9-10R, ME7-10BM, ME9-10BM, ME9-10BMS, ME9-15BM, ME9-15BMS, MG7-10, MG7-10BM, MG9-10, MG-9100, MG9-10AD...(Other models you can see in the webshop) |                 |                     |

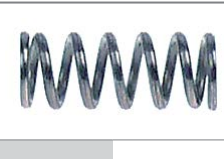

|                    |   |                 |                     |
|--------------------|---|-----------------|---------------------|
| <b>GEV No.</b>     | 700765  | <b>Ref. No.</b> | 12024164<br>T130506 |
| <b>description</b> | compression spring $\varnothing$ 8.1mm L 20.4mm wire gauge $\varnothing$ 1.2mm  |                 |                     |
| <b>For models:</b> | ACE-201, ACE-202, ACG-201, ACG-202, AE-201, AE-202, AG-201, AG-202, APE-201, APE-202, APG-201, APG-202, COE-201, COE-202, COG-201, COG-202, HCG-10-11, HCG-10-21, HCG-20-11, HCG-20-21, HCG-2-10-11, HCG-2-20-11, HCG-6-11, HEI-10-11, HEI-10-21, HEI-20-11, HEI-20-21, HEI-6-11, HEM-10-11, HEM-10-21, HEM-20-11, HEM-20-21, HEM-6-11, HEP-10-11, HEP-10-21, HEP-20-11, HEP-20-21, HEP-6-11, HGC-10-11, HGC-10-21, HGC-20-11, HGC-20-21, HGC-6-11, HGP-10-21, HGP-20-21, HGV-10-11, HGV-10-21, HGV-20-11, HGV-20-21, HME-10-11...(Other models you can see in the webshop) |                 |                     |

Зип-Общепит

vsezip.ru

+7(812)987-08-81



|                    |  |                 |                     |
|--------------------|--|-----------------|---------------------|
| <b>GEV No.</b>     | 691016   | <b>Ref. No.</b> | 12009030<br>S116121 |
| <b>description</b> | torsion spring $\varnothing$ 44mm L 124mm wire gauge $\varnothing$ 5.6mm   |                 |                     |
| <b>For models:</b> | ME9-10BM, ME9-10BMS, ME9-15BM, ME9-15BM316, ME9-15BM5, MG9-10, MG-9100, MG9-10BM, MG9-10BMS, MG9-10S, MG9-15, MG-9150, MG-9150BM, MG9-15BM, MG9-15BMS, MG9-15S, MG9-20, MG-9200, MG9-20S, MPE9-10BM, MPE9-10BMS, MPE9-15BM, MPE9-15BMS, MPG9-10, MPG9-10BM, MPG9-10BMS, MPG9-10S, MPG9-15, MPG-9150, MPG9-15BM, MPG9-15BMS, MPG9-15S, MPG9-20, MPG-9200, MPG9-20S, MV9-10BM, MV9-15BM, SBE7-10, SBE9-10, SBE9-10I, SBE9-10IM, SBE9-10IMS, SBE9-10IS, SBE9-10M, SBE9-10MS, SBE9-10S, SBE9-10USMC, SBE9-15IM, SBE9-15IMS, SBE9-15M...(Other models you can see in the webshop) |                 |                     |

accessories

holders



|                    |  |                 |                     |
|--------------------|--|-----------------|---------------------|
| <b>GEV No.</b>     | 517431   | <b>Ref. No.</b> | 12011392<br>Z270515 |
| <b>description</b> | bracket for roller spring $\varnothing$ mm L 105mm W 44mm H 20mm   |                 |                     |
| <b>For models:</b> | ECO-160, ECO-160D, ECO-160I, ECO-200, ECO-200D, ECO-200H, ECO-200HD, ECO-200HI, ECO-200I, FI-160, FI-160AR, FI-160D, FI-160I, FI-200, FI-200AR, FI-200D, FI-200H, FI-200HD, FI-200HI, FI-200I, FI-200W, FI-200WL, FI-200WR |                 |                     |

roller springs

roller springs



|                    |  |                 |                     |
|--------------------|--|-----------------|---------------------|
| <b>GEV No.</b>     | 501430   | <b>Ref. No.</b> | 12024877<br>Z310511 |
| <b>description</b> | roller spring W 40mm ID $\varnothing$ 33mm lug length 49mm mounting distance 10mm  |                 |                     |
| <b>For models:</b> | ECO-280D, ECO-280I, ECO-370D, ECO-370I, ECO-460D, ECO-460I, ECO-550D, ECO-550I, FI-280D, FI-280I, FI-370D, FI-370I, FI-460D, FI-460I, FI-550D, FI-550I |                 |                     |

miscellaneous



|                    |   |                 |                        |
|--------------------|---|-----------------|------------------------|
| <b>GEV No.</b>     | 513328  | <b>Ref. No.</b> | 12024244<br>T840509000 |
| <b>description</b> | spring for combi-steamer L 34mm W 27mm wire gauge $\varnothing$ 0.6mm |                 |                        |



|                    |  |                 |                     |
|--------------------|--|-----------------|---------------------|
| <b>GEV No.</b>     | 519451   | <b>Ref. No.</b> | 12024689<br>Z270513 |
| <b>description</b> | roller spring W 40mm ID $\varnothing$ 35mm lug length 50mm   |                 |                     |
| <b>For models:</b> | ECO-160, ECO-160D, ECO-160I, ECO-200, ECO-200D, ECO-200H, ECO-200HD, ECO-200HI, ECO-200I, ECO-2700D, ECO-2700I, ECO-280D, ECO-280I, ECO-370D, ECO-370I, ECO-4000D, ECO-4000I, ECO-460D, ECO-460I, ECO-550D, ECO-550I, ECO-6000D, ECO-6000I, FI-160, FI-160AR, FI-160D, FI-160I, FI-200, FI-200AR, FI-200D, FI-200H, FI-200HD, FI-200HI, FI-200I, FI-200W, FI-200WL, FI-200WR, FI-2700D, FI-2700I, FI-280D, FI-280I, FI-370D, FI-370I, FI-4000D, FI-4000I, FI-460D, FI-460I, FI-550D, FI-550I, FI-6000D...(Other models you can see in the webshop) |                 |                     |



|                    |  |                 |                     |
|--------------------|--|-----------------|---------------------|
| <b>GEV No.</b>     | 504387   | <b>Ref. No.</b> | 12024391<br>Z271204 |
| <b>description</b> | spring right for transport system shaft diameterrmm $\varnothing$ 10.5mm L 36mm Wmm Hmm wire gauge $\varnothing$ 1.4mm   |                 |                     |
| <b>For models:</b> | ECO-160, ECO-160D, ECO-160I, ECO-200, ECO-200D, ECO-200H, ECO-200HD, ECO-200HI, ECO-200I, ECO-280D, ECO-280I, ECO-370D, ECO-370I, ECO-460D, ECO-460I, ECO-550D, ECO-550I, FI-160, FI-160AR, FI-160D, FI-160I, FI-200, FI-200AR, FI-200D, FI-200H, FI-200HD, FI-200HI, FI-200I, FI-200W, FI-200WL, FI-200WR, FI-280D, FI-280I, FI-370D, FI-370I, FI-460D, FI-460I, FI-550D, FI-550I |                 |                     |

tension springs



|                    |   |                 |                     |
|--------------------|---|-----------------|---------------------|
| <b>GEV No.</b>     | 505009  | <b>Ref. No.</b> | 12024948<br>Z710528 |
| <b>description</b> | tension spring $\varnothing$ 35mm total length 420mm wire gauge $\varnothing$ 5mm   |                 |                     |
| <b>For models:</b> | AD-120, AD-120B, AD-120BBTDD-UK, AD-90, AD-90BA, AD-90BBT, AD-90BDD, AD-90DD, ADE-120, ADE-120B, ECO-120, ECO-120B, FI-100, FI-100AR, FI-100B, FI-100BBT-UK, FI-120, FI-120AR+DD, FI-120B, FI-120C, FI-120HY-CLINIC, FI-120W, FI-80, FI-80AR, FI-80BBT-UK, FI-80W, FI-E-100, LABP-1000, LABP-1200, LABP-800, MF-120 |                 |                     |



coffee accessories

coffee grounds drawers

|                    |   |
|--------------------|---|
| 1                  |  |
| <b>GEV No.</b>     | 698839  |
| <b>Ref. No.</b>    | 6009290005  |
| <b>description</b> | coffee drawer bar ø 35mm L 375mm  |

kitchen accessories

gastronorm

bridges

|                    |   |
|--------------------|---|
| 1                  |  |
| <b>GEV No.</b>     | 700807  |
| <b>Ref. No.</b>    | 12002780<br>R966104   |
| <b>description</b> | bridge for Gastronorm container L1 327mm L2 307mm SS W 25mm H 15mm Qty 1 pcs      |
| <b>For models:</b> | BME6-05, BME7-05  |

manometers

|                    |  |
|--------------------|--|
| 1                  |    |
| <b>GEV No.</b>     | 541596   |
| <b>Ref. No.</b>    | 12025146<br>Z102316  |
| <b>description</b> | manometer ø 52mm pressure range 0 up to 10bar connection dishwasher thread 1/4"  |
| <b>For models:</b> | ECO-160, ECO-1600, ECO-200, ECO-200H, ECO-2300, ECO-3000, FI-160, FI-1600, FI-160AR, FI-160D, FI-160I, FI-200, FI-200AR, FI-200D, FI-200H, FI-200HD, FI-200HI, FI-200I, FI-2300, FI-2700D, FI-2700I, FI-280D, FI-280I, FI-3000, FI-370D, FI-370I, FI-4000D, FI-4000I, FI-460D, FI-460I, FI-550D, FI-550I, FI-6000D, FI-6000I |



|                    |   |
|--------------------|---|
| 1                  |  |
| <b>GEV No.</b>     | 541579  |
| <b>Ref. No.</b>    | 12038013<br>ICR10022  |
| <b>description</b> | manometer ø 52mm pressure range 0 up to 1bar connection marking 0.5 thread 1/4"     |

Зип Общепит

vsezip.ru

+7(812)987-08-81

|                    |  |
|--------------------|--|
| 1                  |  |
| <b>GEV No.</b>     | 541793   |
| <b>Ref. No.</b>    | 12019289<br>12024625<br>Z271125<br>Z718417   |
| <b>description</b> | manometer ø 52mm pressure range 0-4bar thread 1/4"                                 |
| <b>For models:</b> | AD-120CW, CO-142W, CO-142WDD, FI-120W, FI-200W, FI-200WL, FI-200WR, FI-80W, MF-120 |

|   |  |
|---|--|
| 1   |   |
| <b>GEV No.</b>  | 541062   |
| <b>Ref. No.</b>   | 12009399<br>9220815  |
| <b>description</b>  | manometer ø 63mm pressure range 0 up to 1bar connection marking adjustable kettle thread 1/4"  |
| <b>For models:</b>  | ME9-10BM, ME9-10BMS, ME9-10PLUS-BM, ME9-10PLUS-BMS, ME9-15BM, ME9-15BM316, ME9-15BM-AD, ME9-15BMS, ME9-15PLUS-BM, ME9-15PLUS-BMS, MG9-10BM, MG9-10BMAD, MG9-10BMS, MG9-10BMSAD, MG9-10PLUS-BM, MG9-10PLUS-BMS, MG-9150BM, MG9-15BM, MG9-15BM316, MG9-15BMAD, MG9-15BMS, MG9-15BMSAD, MG9-15PLUS-BM, MG9-15PLUS-BMS, MPE9-10BM, MPE9-10BMS, MPE9-15BM, MPE9-15BMS, MPG9-10BM, MPG9-10BMS, MPG9-15BM, MPG9-15BMS, MV9-10BM, MV9-15BM |
| <b>spare parts for</b>  | 541062   |
|  | <b>GEV No.</b> 541130 <b>Ref. No.</b> —  |
|   | glass panel ø 58mm thickness 2mm   |

hose reels and spray guns

spray guns

|   |   |
|---|---|
| 1   |  |
| <b>GEV No.</b>  | 540302  |
| <b>Ref. No.</b>   | 12030181<br>RT20601006  |
| <b>description</b>  | spray gun for appliances 1/2" ET L 135mm type RATIONAL                              |
| <b>spare parts for</b>  | 540302  |
|  | <b>GEV No.</b> 517056 <b>Ref. No.</b> —   |
|   | O-ring EPDM thickness 2mm ID ø 6.5mm Qty 1 pcs                                      |
|  | <b>GEV No.</b> 532535 <b>Ref. No.</b> —   |
|   | O-ring EPDM thickness 5mm ID ø 10mm Qty 1 pcs                                       |
|  | <b>GEV No.</b> 548016 <b>Ref. No.</b> —   |
|   | compression spring ø 10mm L 17mm wire gauge ø 0.9mm for hand spray                  |

Table continues overleaf

Зип Общепит

vsezip.ru

+7(812)987-08-81

|   |                |        |                   |
|---|----------------|--------|-------------------|
| <b>spare parts for</b> 540302   |                |        |                   |
|  | <b>GEV No.</b> | 548017 | <b>Ref. No.</b> — |
| pressure bolt for hand spray  |                |        |                   |

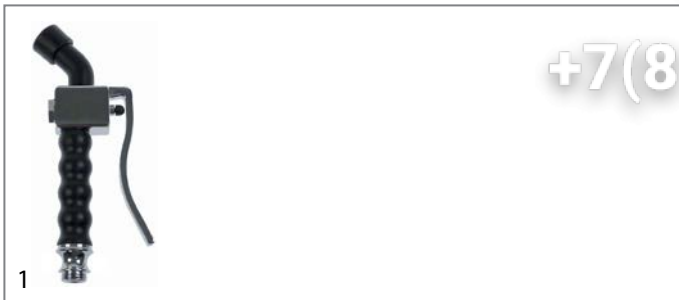

|                |        |                 |                     |
|----------------|--------|-----------------|---------------------|
| <b>GEV No.</b> | 691048 | <b>Ref. No.</b> | 12004216<br>R095005 |
|----------------|--------|-----------------|---------------------|

**description** spray gun for appliances 1/2" ET L 225mm type STAR

**For models:** HCG-10-11, HCG-10-21, HCG-20-11, HCG-20-21, HCG-2-10-11, HCG-2-20-11, HCG-6-11, HME-10-11, HME-10-21, HME-20-11, HME-20-21, HME-2-10-11, HME-2-20-11, HME-6-11, HMG-10-11, HMG-10-11UL, HMG-10-21, HMG-10-21UL, HMG-20-11, HMG-2-10-11, HMG-6-11, HMI-10-11, HMI-10-11UL, HMI-10-21, HMI-10-21UL, HMI-2-10-11, HMI-6-11, HMI-6-11UL, HMM-10-11, HMM-10-11UL, HMM-10-21, HMM-10-21UL, HMM-20-11, HMM-20-11UL, HMM-20-21, HMM-20-21UL, HMM-2-10-11, HMM-2-20-11, HMM-40-11-USMC, HMM-6-11, HMM-6-11UL, HMP-10-11, HMP-10-21, HMP-20-11, HMP-20-21, HMP-2-10-11, HMP-2-20-11, HMP-6-11, HVG-10-11, HVG-10-11UL...(Other models you can see in the webshop)

**spare parts for** 691048

|  |                |        |                   |
|--|----------------|--------|-------------------|
|  | <b>GEV No.</b> | 507309 | <b>Ref. No.</b> — |
|--|----------------|--------|-------------------|

O-ring EPDM thickness 2.62mm ID ø 17.13mm Qty 1 pcs

|   |                |        |                   |
|---|----------------|--------|-------------------|
|  | <b>GEV No.</b> | 510322 | <b>Ref. No.</b> — |
|---|----------------|--------|-------------------|

O-ring EPDM thickness 1.78mm ID ø 17.17mm Qty 1 pcs

|   |                |        |                   |
|---|----------------|--------|-------------------|
|  | <b>GEV No.</b> | 524055 | <b>Ref. No.</b> — |
|---|----------------|--------|-------------------|

flat gasket rubber ED ø 18mm ID ø 12mm thickness 2mm Qty 1 pcs

|   |                |        |                   |
|---|----------------|--------|-------------------|
|  | <b>GEV No.</b> | 528485 | <b>Ref. No.</b> — |
|---|----------------|--------|-------------------|

O-ring EPDM thickness 1.78mm ID ø 6.07mm Qty 1 pcs

|   |                |        |                   |
|---|----------------|--------|-------------------|
|  | <b>GEV No.</b> | 528494 | <b>Ref. No.</b> — |
|---|----------------|--------|-------------------|

gasket rubber ED ø 13mm ID ø 4mm thickness 4mm Qty 1 pcs

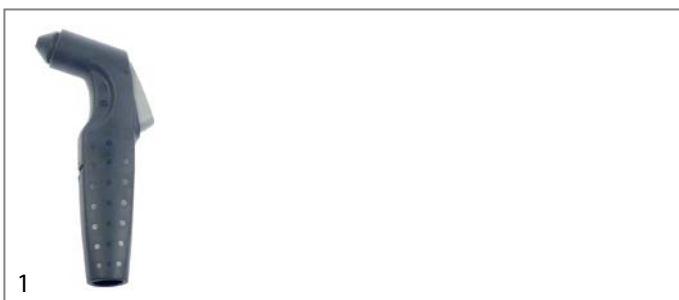

|                |        |                 |                       |
|----------------|--------|-----------------|-----------------------|
| <b>GEV No.</b> | 540664 | <b>Ref. No.</b> | 12030307<br>RT5000130 |
|----------------|--------|-----------------|-----------------------|

**description** spray gun for appliances 1/2" (12.83mm) L 165mm

**spare parts for** 540664

|   |                |        |                                       |
|---|----------------|--------|---------------------------------------|
|  | <b>GEV No.</b> | 699809 | <b>Ref. No.</b> 12037366<br>RT5000156 |
|---|----------------|--------|---------------------------------------|

clamp for spray gun L 24mm

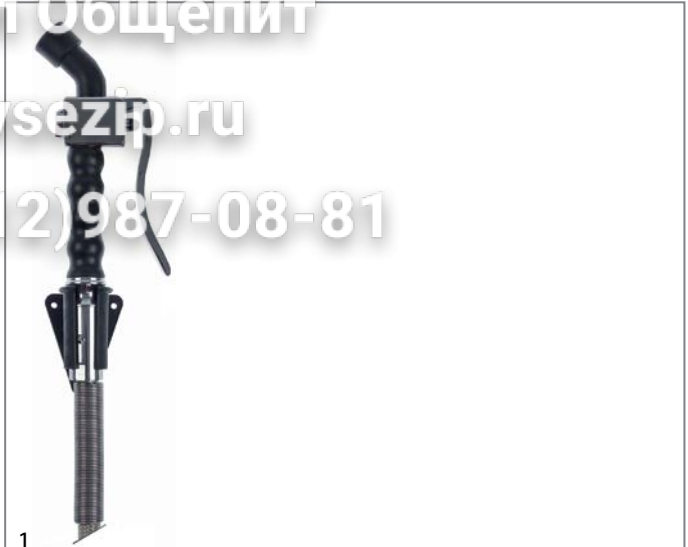

|                |        |                 |                     |
|----------------|--------|-----------------|---------------------|
| <b>GEV No.</b> | 691618 | <b>Ref. No.</b> | 12007934<br>R095009 |
|----------------|--------|-----------------|---------------------|

**description** spray gun for appliances 1/2" ET L 225mm with hose (2m) and wall holder type STAR

**For models:** HEM-10-11, HEM-20-11, HEM-6-11, HEP-10-11, HEP-20-11, HEP-6-11, HGV-10-11, HGV-20-11

**spare parts for** 691618

|   |                |        |                   |
|---|----------------|--------|-------------------|
|  | <b>GEV No.</b> | 542966 | <b>Ref. No.</b> — |
|---|----------------|--------|-------------------|

wall holder for hand spray



|                |        |                 |                     |
|----------------|--------|-----------------|---------------------|
| <b>GEV No.</b> | 691094 | <b>Ref. No.</b> | 12020555<br>R095007 |
|----------------|--------|-----------------|---------------------|

**description** wall holder for hand spray

**For models:** HCG-10-11, HCG-10-21, HCG-20-11, HCG-20-21, HCG-2-10-11, HCG-2-20-11, HCG-6-11, HME-10-11, HME-10-21, HME-20-11, HME-20-21, HME-2-10-11, HME-2-20-11, HME-6-11, HMG-10-11, HMG-10-11UL, HMG-10-21, HMG-10-21UL, HMG-20-11, HMG-2-10-11, HMG-6-11, HMI-10-11, HMI-10-11UL, HMI-10-21, HMI-10-21UL, HMI-2-10-11, HMI-6-11, HMI-6-11UL, HMM-10-11, HMM-10-11UL, HMM-10-21, HMM-10-21UL, HMM-20-11, HMM-20-11UL, HMM-20-21, HMM-20-21UL, HMM-2-10-11, HMM-2-20-11, HMM-40-11-USMC, HMM-6-11, HMM-6-11UL, HMP-10-11, HMP-10-21, HMP-20-11, HMP-20-21, HMP-2-10-11, HMP-2-20-11, HMP-6-11, HVG-10-11, HVG-10-11UL...(Other models you can see in the webshop)



hose reels

appliance hose reels



1

|                    |   |                 |                      |
|--------------------|---|-----------------|----------------------|
| <b>GEV No.</b>     | 542093  | <b>Ref. No.</b> | 12024800<br>12040977 |
| <b>description</b> | hose reel complete with spray gun hose length 1.8m  |                 |                      |
| <b>For models:</b> | AE-061, AE-061W, AE-101, AE-101W, AE-102, AE-102W, AE-201, AE-202, AG-061, AG-061W, AG-101, AG-101W, AG-102, AG-102W, AG-201, AG-202, APE-061, APE-061W, APE-101, APE-101W, APE-102, APE-102W, APE-201, APE-202, APG-061, APG-061W, APG-101, APG-101W, APG-102, APG-102W, APG-201, APG-202, COG-202, HEM-20-21, HEP-10-21, HEP-20-21, HGP-10-21, HGP-20-21, HGV-20-21, VE-061, VE-101, VE-102, VE-201, VE-202, VG-101, VG-102, VG-201, VG-202, VPE-061, VPE-101...(Other models you can see in the webshop) |                 |                      |



1

|                    |  |                 |                        |
|--------------------|--|-----------------|------------------------|
| <b>GEV No.</b>     | 541444                                       | <b>Ref. No.</b> | 12026185<br>RT5000176P |
| <b>description</b> | hose reel without spray gun hose length 1.5m |                 |                        |



1

|                        |  |                 |   |                        |
|------------------------|--|-----------------|---|------------------------|
| <b>GEV No.</b>         | 540661   | <b>Ref. No.</b> | 12026732<br>12026734<br>RT5000140<br>RT5000140P |                        |
| <b>description</b>     | hose reel without spray gun hose length 1m                   |                 |   |                        |
| <b>accessories for</b> | 540661   |                 |   |                        |
|                        | <b>GEV No.</b>   | 540664          | <b>Ref. No.</b>                                 | 12030307<br>RT5000130  |
|                        | spray gun for appliances 1/2" (12.83mm) L 165mm              |                 |   |                        |
|                        | <b>GEV No.</b>   | 560630          | <b>Ref. No.</b>                                 | 12037727<br>RT11070100 |
|                        | clamping washer nominal-ø 4mm ED ø 11.5mm SS thickness 0.2mm |                 |   |                        |
|                        | <b>GEV No.</b>   | 694491          | <b>Ref. No.</b>                                 | —                      |
|                        | supply tube for hose reel                                    |                 |   |                        |
|                        | <b>GEV No.</b>   | 699802          | <b>Ref. No.</b>                                 | —                      |
|                        | cover for spray gun D1 ø 90/145mm L 145mm H 68mm             |                 |   |                        |

Зип Общепит

vsezip.ru

+7(812)987-08-81



1

|                    |  |                 |                        |
|--------------------|--|-----------------|------------------------|
| <b>GEV No.</b>     | 540483                                       | <b>Ref. No.</b> | 12026642<br>RT86552020 |
| <b>description</b> | hose reel without spray gun hose length 2.1m |                 |                        |

dosing pumps

peristaltic dosing pumps

GERMAC

built-in version

with frequency control



1

|                        |   |                 |                        |  |
|------------------------|---|-----------------|------------------------|--|
| <b>GEV No.</b>         | 361795 <sup>1</sup>   | <b>Ref. No.</b> | 1200000132<br>19022347 |  |
| <b>description</b>     | dosing pump GERMAC frequency control 3l/h 230VAC detergent hose ø 4x6mm hose thermoplastic type G300 3.5W 230V code 82334968 installation kit inclusive   |                 |                        |  |
| <b>For models:</b>     | CO-110DD, CO-112DD, CO-142WDD, CO-170DD, CO-172DD, CO-350-COLD-DD, CO-350-DD, CO-400-COLD-DD, CO-400-DD, CO-402-COLD, CO-402-COLD-B, CO-402-COLD-B-DD, CO-402-COLD-DD, CO-402W, CO-500DD, CO-501DD, CO-502DD, CO-502W, COP-173DD, COP-174DD, COP-174W, COP-174WHR, COP-503DD, COP-504DD, COP-504W, FI-30, FI-30AR, FI-30AR+DD, FI-30-UK, FI-48, FI-48AR, FI-48B, FI-48B-BT-UK, FI-48C, FI-48D, FI-48HY-CLINIC, FI-48W, FI-64, FI-64AR, FI-64B, FI-64B-BT-UK, FI-64C, FI-64D, FI-64HY-CLINIC, FI-64W, FI-72, FI-72AR, FI-72W |                 |                        |  |
| <b>spare parts for</b> | 361795  |                 |                        |  |
|                        | <b>GEV No.</b>  | 361142          | <b>Ref. No.</b>        | —  |
|                        | mounting set detergent hose type 4x6mm hose length 2m PVC 2x hose/container filter/tank intake transparent  |                 |                        |  |
|                        | <b>GEV No.</b>  | 361268          | <b>Ref. No.</b>        | 12017199<br>12024224<br>Z209521<br>Z209530 |
|                        | dosing pump GERMAC frequency control 3l/h 230VAC detergent hose ø 4x6mm hose thermoplastic type G300 built-in version dimensions 67x72x101mm  |                 |                        |  |
|                        | <b>GEV No.</b>  | 361467          | <b>Ref. No.</b>        | —  |
|                        | pump hose GERMAC detergent hose type thermoplastic hose ø 6x10mm for model G43/G45/G53/G54/G55/G300/G305  |                 |                        |  |







<sup>1</sup>with accessories













Зип Общепит  
membrane dosing pumps

self-priming  
vsezip.ru  
LANG

+7(812)987-08-81

|   |  |                 |  |
|---|--|-----------------|--|
|    |  |                 |  |
| 1   |  |                 |  |
| <b>GEV No.</b>  | 361268   | <b>Ref. No.</b> | 12017199<br>12024224<br>Z209521<br>Z209530 |
| <b>description</b>  | dosing pump GERMAC frequency control 3l/h 230VAC detergent hose ø 4x6mm hose thermoplastic type G300 built-in version dimensions 67x72x101mm |                 |  |
| <b>For models:</b>  | FI-30, FI-48, FI-48B, FI-48W, FI-50, FI-64, FI-64B, FI-64W, FI-72, MF-48, MF-64  |                 |  |
| <b>spare parts for</b>  | 361268   |                 |  |
|    | <b>GEV No.</b>   | 361467          | <b>Ref. No.</b> —                          |
|   | pump hose GERMAC detergent hose type thermoplastic hose ø 6x10mm for model G43/G45/G53/G54/G55/G300/G305                                     |                 |  |
|    | <b>GEV No.</b>   | 361557          | <b>Ref. No.</b> —                          |
|   | control PCB type G300/G302/G305 GERMAC   |                 |  |
|    | <b>GEV No.</b>   | 361589          | <b>Ref. No.</b> —                          |
|   | roller assembly GERMAC suitable for G42/43/45/53/54/55/300/302/305/705   |                 |  |
| <b>accessories for</b>  | 361268   |                 |  |
|  | <b>GEV No.</b>   | 361106          | <b>Ref. No.</b> —                          |
|   | container filter with weight and non-return valve SS hose ø 4x6mm ø 21mm L 51mm non return valve lip valve                                   |                 |  |
|  | <b>GEV No.</b>   | 520090          | <b>Ref. No.</b> —                          |
|   | PVC hose ID ø 4mm ED ø 6mm L 2m thickness 1mm t.max. 60°C transparent  |                 |  |
|  | <b>GEV No.</b>   | 520091          | <b>Ref. No.</b> —                          |
|   | nylon hose ID ø 4mm ED ø 6mm L 2m thickness 1mm operating p. 10bar burst p. 50bar t.max. 100°C transparent                                   |                 |  |

|   |  |                 |  |
|---|--|-----------------|--|
|   |  |                 |  |
| 1   |  |                 |  |
| <b>GEV No.</b>  | 361221   | <b>Ref. No.</b> | 12024105<br>12039170<br>Z211109<br>Z651123 |
| <b>description</b>  | dosing pump type N6 rinse aid pressure connection ø 4x6mm suction connection ø 6x8mm LANG  |                 |  |
| <b>For models:</b>  | AD-120, AD-120B, AD-120C, AD-120CW, AD-15, AD-15D, AD-20C-UK, AD-21, AD-21B, AD-21BDD, AD-21C, AD-21D, AD-21DD, AD-21W, AD-48, AD-48B, AD-48BDD, AD-48C, AD-48D, AD-48DD, AD-48W, AD-64, AD-64B, AD-64BDD, AD-64C, AD-64CW, AD-64D, AD-64DD, AD-72, AD-72W, AD-90, AD-90BA, AD-90BDD, AD-90DD, ADE-120, ADE-120B, ECO-120, ECO-1200, ECO-120B, FI-100, FI-100AR, FI-100B, FI-100BBT-UK, FI-120, FI-1200, FI-120AR+DD, FI-120B, FI-120C, FI-120HY-CLINIC, FI-120W...(Other models you can see in the webshop) |                 |  |
| <b>spare parts for</b>  | 361221   |                 |  |
|    | <b>GEV No.</b>   | 361079          | <b>Ref. No.</b> —                          |
|   | spring for type N5/N6 for ball   |                 |  |
|  | <b>GEV No.</b>   | 361080          | <b>Ref. No.</b> —                          |
|   | O-ring EPDM thickness 2mm ID ø 16mm Qty 1 pcs  |                 |  |
|  | <b>GEV No.</b>   | 361085          | <b>Ref. No.</b> —                          |
|   | O-ring EPDM thickness 2mm ID ø 8mm Qty 1 pcs   |                 |  |
|  | <b>GEV No.</b>   | 361309          | <b>Ref. No.</b> —                          |
|   | ball for type N5/N6  |                 |  |
|  | <b>GEV No.</b>   | 361310          | <b>Ref. No.</b> —                          |
|   | bracket for type N6 ball guide   |                 |  |
|  | <b>GEV No.</b>   | 361311          | <b>Ref. No.</b> —                          |
|   | O-ring EPDM thickness 2mm ID ø 6mm Qty 1 pcs for type N6   |                 |  |
|  | <b>GEV No.</b>   | 361314          | <b>Ref. No.</b> —                          |
|   | valve ring for type N6 holder for O-ring   |                 |  |
|  | <b>GEV No.</b>   | 361317          | <b>Ref. No.</b> —                          |
|   | sealing disc for type N6   |                 |  |
|  | <b>GEV No.</b>   | 361886          | <b>Ref. No.</b> —                          |
|   | non-return valve inletmm outletmm outlet ø 12.4mm L 12.7mm   |                 |  |







Зип Общежит

vsezip.ru

+7(812)987-08-81

water and beverage technology

| accessories  |   |                 |  |
|--|---|-----------------|--|
|  <p>1</p> |   |                 |  |
| <b>GEV No.</b>   | 101286  | <b>Ref. No.</b> | 12008476<br>S312108000<br>X205028          |
| <b>description</b>   | olive ID ø 6mm Qty 1 pcs  |                 |  |
| <b>For models:</b>   | BMG7-10, BMG-9045, BMG9-05, BMG9-05V-T, BMG9-10, BMG9-10V-T, CG-1002, CG-1502, CG-2000, CG-2000-2P, CG-2002, CG-2002P, CG-200S, CG-210, CG-210G, CG-300S, CG-310, CG-310G, CG6-41, CG7-10, CG7-11, CG-7115, CG7-41, CG-7415, CG7-61, CG-7615, CG9-05AD, CG9-05PLUS, CG9-10, CG9-10AD, CG9-10PLUS, CG9-11, CG-9110, CG9-11AD, CG9-11PLUS, CG9-20AD, CG9-20AD-H, CG9-20PLUS, CG9-20PLUS-H, CG9-31PLUS-D, CG9-31PLUS-I, CG9-40AD, CG9-40AD-H, CG9-40PLUS, CG9-40PLUS-H, CG9-41, CG9-41AD, CG9-41AD-H, CG9-41PLUS, CG9-41PLUS-H...(Other models you can see in the webshop) |                 |  |
| <b>accessories for</b>   | 101286  |                 |  |
|           |   |                 |  |
| <b>GEV No.</b>   | 100909  | <b>Ref. No.</b> | 12008740<br>12016658<br>S312107<br>U265703 |
| <b>description</b>   | union screw thread M10x1 for pipe ø 6mm Qty 1 pcs   |                 |  |
|           |   |                 |  |
| <b>GEV No.</b>   | 101464  | <b>Ref. No.</b> | —  |
| <b>description</b>   | union nut thread M12x1 for pipe ø 6mm   |                 |  |

| various  |   |                 |          |
|--|---|-----------------|----------|
|  <p>1</p> |   |                 |          |
| <b>GEV No.</b>   | 361015  | <b>Ref. No.</b> | 12045206 |
| <b>description</b>   | dosing pump membrane dosing pump rinse aid inlet 6x8mm outlet 4x6mm pressure connection ø 4x6mm suction connection ø 6x8mm  |                 |          |
| <b>For models:</b>   | AD-120, AD-120B, AD-120C, AD-15, AD-15D, AD-20C-UK, AD-21, AD-21B, AD-21BDD, AD-21C, AD-21D, AD-21W, AD-48, AD-48B, AD-48BDD, AD-48C, AD-48D, AD-48DD, AD-48W, AD-64, AD-64B, AD-64BDD, AD-64C, AD-64CW, AD-64DD, AD-72, AD-72W, AD-90, AD-90BA, AD-90BDD, AD-90DD, ADE-120, ADE-120B, CO-110, CO-110B, CO-110BDD, CO-110DD, CO-112, CO-112B, CO-112BDD, CO-112DD, CO-142W, CO-142WDD, CO-170, CO-170B, CO-170BDD, CO-170DD, CO-170HRS, CO-170HRSDD, CO-170HRS-SOFT...(Other models you can see in the webshop) |                 |          |
| <b>spare parts for</b>   | 361015  |                 |          |
|           |   |                 |          |
| <b>GEV No.</b>   | 361132  | <b>Ref. No.</b> | —        |
| <b>description</b>   | membrane dosing pump  |                 |          |
|           |   |                 |          |
| <b>GEV No.</b>   | 510298  | <b>Ref. No.</b> | —        |
| <b>description</b>   | lip valve dosing pump suitable for DB2/DS5  |                 |          |

| accessories   |   |                 |                     |
|---|---|-----------------|---------------------|
|  <p>1</p> |   |                 |                     |
| <b>GEV No.</b>  | 361062  | <b>Ref. No.</b> | 12011355<br>Z601153 |
| <b>description</b>  | container filter hose ø 4mm   |                 |                     |
| <b>For models:</b>  | AD-125, AD-125HRS, AD-125-SOFT, AD-505, CO-110DD, CO-112DD, CO-142WDD, CO-170DD, CO-172DD, COP-173, COP-173B, COP-173BDD, COP-173DD, COP-173HRS, COP-173HRSDD, COP-173-SOFT, COP-174, COP-174B, COP-174BDD, COP-174DD, COP-174HRS, COP-174HRSDD, COP-174W, COP-174WHRS, COP-503, COP-503B, COP-503BDD, COP-503DD, COP-503-SOFT, COP-504, COP-504B, COP-504BDD, COP-504DD, COP-504W, ECO-120, ECO-1200, ECO-120B, FI-100, FI-100AR, FI-100B, FI-120, FI-1200, FI-120B, FI-120W, FI-30, FI-300B, FI-300R, FI-48, FI-48B, FI-48W...(Other models you can see in the webshop) |                 |                     |

| filter weights  |  |                 |          |
|---|--|-----------------|----------|
|  <p>1</p> |  |                 |          |
| <b>GEV No.</b>  | 505409   | <b>Ref. No.</b> | 12024353 |
| <b>description</b>  | filter weight ID ø 7.6mm ext. ø 20 L 6mm 12g SS  |                 |          |
| <b>For models:</b>  | AD-125, AD-125HRS, AD-125-SOFT, AD-505, AD-505-SOFT, AD-64BTDD, CO-110DD, CO-112DD, CO-142WDD, CO-170DD, CO-172DD, CO-350-COLD-DD, CO-350-DD, CO-400-COLD-DD, CO-400-DD, CO-402-COLD, CO-402-COLD-B, CO-402-COLD-B-DD, CO-402-COLD-DD, CO-402W, CO-500DD, CO-501DD, CO-502DD, CO-502W, COP-173, COP-173B, COP-173BDD, COP-173DD, COP-173HRS, COP-173HRSDD, COP-173-SOFT, COP-174, COP-174B, COP-174BDD, COP-174DD, COP-174HRS, COP-174HRSDD, COP-174W, COP-174WHRS, COP-503, COP-503B, COP-503BDD, COP-503DD, COP-503-SOFT, COP-504, COP-504B, COP-504BDD, COP-504DD, COP-504W, EASY-500...(Other models you can see in the webshop) |                 |          |

|   |  |                 |                                 |
|---|--|-----------------|---------------------------------|
|  <p>1</p> |  |                 |                                 |
| <b>GEV No.</b>  | 505197   | <b>Ref. No.</b> | 12024353 old version<br>Z701152 |
| <b>description</b>  | filter weight ID ø 8x9mm ext. ø 14 L 20mm 17g brass  |                 |                                 |
| <b>For models:</b>  | AD-120, AD-120B, AD-120C, AD-120CW, AD-120HY, AD-15, AD-15D, AD-20C-UK, AD-21, AD-21B, AD-21BDD, AD-21C, AD-21D, AD-21DD, AD-21W, AD-45BBT, AD-48, AD-48B, AD-48BDD, AD-48C, AD-48D, AD-48DD, AD-48HY, AD-48W, AD-64, AD-64B, AD-64BBT, AD-64BDD, AD-64C, AD-64CW, AD-64D, AD-64DD, AD-64HY, AD-72, AD-72W, AD-90, AD-90BA, AD-90BBT, AD-90BDD, AD-90DD, ADE-120, ADE-120B, ECO-120, ECO-1200, FI-100, FI-100AR, FI-100B, FI-100BBT-UK, FI-120, FI-1200, FI-120AR+DD...(Other models you can see in the webshop) |                 |                                 |

hose couplings

plastic



1

|                    |   |                 |                        |
|--------------------|---|-----------------|------------------------|
| <b>GEV No.</b>     | 361102  | <b>Ref. No.</b> | 12036245<br>RT20620339 |
| <b>description</b> | hose connector plastic angled thread M10x1 hose ø 6mm Qty 1 pcs connection M10x1 hose ø 6mm |                 |                        |



1

|                    |   |                 |                        |
|--------------------|---|-----------------|------------------------|
| <b>GEV No.</b>     | 361100  | <b>Ref. No.</b> | 12036489<br>RT20620351 |
| <b>description</b> | hose connector plastic straight thread M10x1 hose ø 6mm Qty 1 pcs connection M10x1 hose ø 6mm |                 |                        |

T-pieces

without non-return valve



1

|                    |  |                 |                     |
|--------------------|--|-----------------|---------------------|
| <b>GEV No.</b>     | 505086   | <b>Ref. No.</b> | 12025288<br>Z601157 |
| <b>description</b> | T-piece connection 1: 10mm connection 2: 4mm   |                 |                     |
| <b>For models:</b> | AD-120, AD-120B, AD-120C, AD-120CW, AD-125, AD-125HRS, AD-15, AD-15D, AD-20C-UK, AD-21, AD-21B, AD-21BDD, AD-21C, AD-21D, AD-21DD, AD-21W, AD-48, AD-48B, AD-48BDD, AD-48C, AD-48D, AD-48DD, AD-48W, AD-64, AD-64B, AD-64BDD, AD-64C, AD-64CW, AD-64D, AD-64DD, AD-72, AD-72W, AD-90, AD-90BA, AD-90BDD, AD-90DD, ADE-120, ADE-120B, CO-110, CO-110B, CO-110BDD, CO-110DD, CO-112, CO-112B, CO-112BDD, CO-112DD, CO-142W, CO-142WDD, CO-170, CO-170B...(Other models you can see in the webshop) |                 |                     |

tank inlets



1

|                    |                                     |                 |            |
|--------------------|-------------------------------------|-----------------|------------|
| <b>GEV No.</b>     | 361105                              | <b>Ref. No.</b> | FAG1200026 |
| <b>description</b> | tank inlet plastic M10 hose ø 4x6mm |                 |            |



1

|                    |   |                 |                        |
|--------------------|---|-----------------|------------------------|
| <b>GEV No.</b>     | 508427                                    | <b>Ref. No.</b> | 12024531<br>Z208927000 |
| <b>description</b> | tank inlet stainless steel M10 hose ø 4mm |                 |                        |

Зип Общепит

vsezip.ru

+7(812)987-08-81



1

|                    |   |                 |         |
|--------------------|---|-----------------|---------|
| <b>GEV No.</b>     | 361656  | <b>Ref. No.</b> | 6000012 |
| <b>description</b> | tank inlet stainless steel M10x1.5 hose ø 4mm |                 |         |

mounting sets

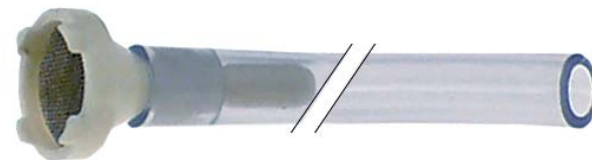

1

|                    |   |                 |                                    |
|--------------------|---|-----------------|------------------------------------|
| <b>GEV No.</b>     | 520398  | <b>Ref. No.</b> | 12003213<br>12Z60115<br>12Z6011500 |
| <b>description</b> | hose detergent hose type 4x6mm hose length 1.3m PVC with filter transparent |                 |                                    |

hoses



supply hoses

PVC supply hoses



1

|                    |  |                 |                     |
|--------------------|--|-----------------|---------------------|
| <b>GEV No.</b>     | 520010   | <b>Ref. No.</b> | 12024115<br>Z602121 |
| <b>description</b> | supply hose PVC straight-curved DN13 connections 3/4" L 1500mm operating p. 10bar burst p. 32bar t.max. 90°C blue approval VDE flat seal   |                 |                     |
| <b>For models:</b> | AD-120, AD-120B, AD-120BTDD-UK, AD-120C, AD-120CW, AD-120HY, AD-125, AD-125HRS, AD-125-SOFT, AD-15D, AD-21D, AD-45BBT, AD-48, AD-48B, AD-48BDD, AD-48C, AD-48D, AD-48DD, AD-48HY, AD-48W, AD-505, AD-64, AD-64B, AD-64BBT, AD-64BDD, AD-64BTDD, AD-64C, AD-64CW, AD-64D, AD-64DD, AD-64HY, AD-72, AD-72W, AD-90, AD-90BA, AD-90BBT, AD-90BDD, AD-90DD, ADE-120, ADE-120B, CO-110, CO-110B, CO-110BDD, CO-110DD, CO-112, CO-112B, CO-112BDD, CO-112DD, CO-142W, CO-142WDD...(Other models you can see in the webshop) |                 |                     |

|   |  |        |                 |                     |
|---|--|--------|-----------------|---------------------|
| <b>accessories for</b>  | 520010   |        |                 |                     |
|  | <b>GEV No.</b>   | 520053 | <b>Ref. No.</b> | 12025278<br>Z701132 |
|   | screen connection 3/4" D1 ø 26mm D2 ø 15mm Qty 10 pcs rubber thickness 8mm |        |                 |                     |
|  | <b>GEV No.</b>   | 520054 | <b>Ref. No.</b> | —                   |
|   | flat gasket rubber ED ø 23.5mm ID ø 14mm thickness 2.3mm Qty 10 pcs        |        |                 |                     |



Зип Общепит

vsezip.ru

+7(812)987-08-81

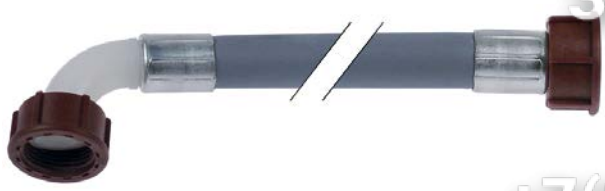

|                    |   |                 |                     |
|--------------------|---|-----------------|---------------------|
| <b>GEV No.</b>     | 520012  | <b>Ref. No.</b> | 12025198<br>Z601114 |
| <b>description</b> | supply hose PVC straight-curved DN13 connections 3/4" L 2500mm operating p. 10bar burst p. 32bar t.max. 90°C approval VDE flat seal   |                 |                     |
| <b>For models:</b> | ACE-061, ACE-101, ACE-102, ACE-201, ACE-202, ACG-061, ACG-101, ACG-102, ACG-201, ACG-202, AD-15, AD-20C-UK, AD-21, AD-21B, AD-21BDD, AD-21C, AD-21DD, AE-061, AE-061W, AE-101, AE-101W, AE-102, AE-102W, AE-201, AE-202, AG-061, AG-061W, AG-101, AG-101W, AG-102, AG-102W, AG-201, AG-202, APE-061, APE-061W, APE-101, APE-101W, APE-102, APE-102W, APE-201, APE-202, APG-061, APG-061W, APG-101, APG-101W, APG-102, APG-102W, APG-201, APG-202, COG-061...(Other models you can see in the webshop) |                 |                     |



|                    |   |                 |                     |
|--------------------|---|-----------------|---------------------|
| <b>GEV No.</b>     | 505081  | <b>Ref. No.</b> | 12024114<br>Z400908 |
| <b>description</b> | drain hose DN25 L 1600mm elbow ø inside 31mm elbow ext. ø 40mm outer hose ø 30mm  |                 |                     |
| <b>For models:</b> | AD-15, AD-15D, AD-21, AD-21D, AD-21DD, ATM-051ECO, CO-350, CO-350-COLD, CO-350-COLD-DD, CO-350-DD, CO-352-COLD, CO-352-COLD-DD, CO-400, CO-400-COLD, CO-400-COLD-DD, CO-400-DD, CO-400-SOFT, CO-402-COLD, CO-402-COLD-DD, ECO-2700D, ECO-2700I, ECO-4000D, ECO-4000I, ECO-6000D, ECO-6000I, FI-2700D, FI-2700I, FI-4000D, FI-4000I, FI-6000D, FI-6000I, GA-20, GA-20D, GA-40, GA-40D, LVC-12, LVC-15, LVC-15D, LVC-21, LVC-21B, LVC-21C, LVC-21D, LVC-21W, LVR-10, LVR-14, LVR-14D, LVR-20, LVR-20D |                 |                     |

pre-rinse hoses

stainless steel flexi hoses



|                    |   |                 |                     |
|--------------------|---|-----------------|---------------------|
| <b>GEV No.</b>     | 691095  | <b>Ref. No.</b> | 12039111<br>R095006 |
| <b>description</b> | shower hose SS with flexible fabric   |                 |                     |
| <b>For models:</b> | HCG-10-11, HCG-10-21, HCG-20-11, HCG-20-21, HCG-2-10-11, HCG-2-20-11, HCG-6-11, HME-10-11, HME-10-21, HME-20-11, HME-20-21, HME-2-10-11, HME-2-20-11, HME-6-11, HMG-10-11, HMG-10-11UL, HMG-10-21, HMG-10-21UL, HMG-20-11, HMG-2-10-11, HMG-6-11, HMI-10-11, HMI-10-11UL, HMI-10-21, HMI-10-21UL, HMI-2-10-11, HMI-6-11, HMI-6-11UL, HMM-10-11, HMM-10-11UL, HMM-10-21, HMM-10-21UL, HMM-20-11, HMM-20-11UL, HMM-20-21, HMM-20-21UL, HMM-2-10-11, HMM-2-20-11, HMM-40-11-USMC, HMM-6-11, HMM-6-11UL, HMP-10-11, HMP-10-21, HMP-20-11, HMP-20-21, HMP-2-10-11, HMP-2-20-11, HMP-6-11, HVG-10-11, HVG-10-11UL...(Other models you can see in the webshop) |                 |                     |

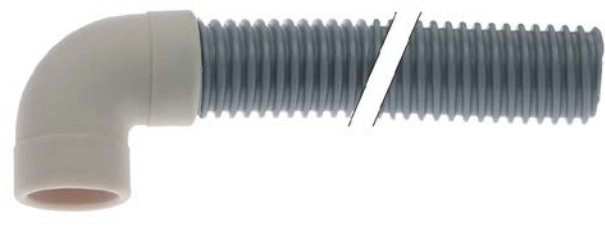

|                    |   |                 |          |
|--------------------|---|-----------------|----------|
| <b>GEV No.</b>     | 505402  | <b>Ref. No.</b> | 12115471 |
| <b>description</b> | drain hose DN25 L 2000mm elbow ø inside 27mm elbow ext. ø 35mm inner hose ø 25mm outer hose ø 30mm plastic      |                 |          |
| <b>For models:</b> | CO-500, CO-500DD, CO-501, CO-501DD, CO-501-SOFT, CO-502DD, COP-503, COP-503DD, COP-503-SOFT, COP-504, COP-504DD |                 |          |

drain hoses



|                    |  |                 |                     |
|--------------------|--|-----------------|---------------------|
| <b>GEV No.</b>     | 505082   | <b>Ref. No.</b> | 12024473<br>Z200910 |
| <b>description</b> | drain hose DN25 L 1500mm elbow ø inside 48mm elbow ext. ø 58mm outer hose ø 31mm   |                 |                     |
| <b>For models:</b> | AD-120, AD-120CW, AD-48, AD-48D, AD-48DD, AD-64, AD-64BTDD, AD-64D, AD-64DD, AD-72, AD-72W, AD-90, AD-90DD, ADE-120, APE-061, APE-101, APE-102, APE-201, APE-202, APG-061, APG-101, APG-102, APG-201, APG-202, CO-110, CO-110B, CO-110BDD, CO-110DD, CO-112DD, CO-142W, CO-142WDD, CO-170, CO-170B, CO-170BDD, CO-170DD, CO-170HRS, CO-170HRSDD, CO-170HRS-SOFT, CO-170-SOFT, CO-172DD, COP-173, COP-173B, COP-173BDD, COP-173DD, COP-173HRS, COP-173HRSDD, COP-173-SOFT, COP-174DD, COP-174W, COP-174WHR... (Other models you can see in the webshop) |                 |                     |



|                    |   |                 |                     |
|--------------------|---|-----------------|---------------------|
| <b>GEV No.</b>     | 505084  | <b>Ref. No.</b> | 12023666<br>Z220903 |
| <b>description</b> | drain hose DN19 L 2000mm straight ø inside 21mm straight ext. ø 26mm elbow ø inside 21mm elbow ext. ø 27mm outer hose ø 27mm  |                 |                     |
| <b>For models:</b> | AD-120B, AD-120BBTDD-UK, AD-120C, AD-120HY, AD-125, AD-125HRS, AD-125-SOFT, AD-20C-UK, AD-21B, AD-21BDD, AD-21C, AD-21W, AD-45BBT, AD-48B, AD-48BDD, AD-48C, AD-48HY, AD-48W, AD-64B, AD-64BBT, AD-64BDD, AD-64C, AD-64CW, AD-64HY, AD-90BA, AD-90BBT, AD-90BDD, ADE-120B, BME7-05, BME7-10, BMG7-10, CO-350-B, CO-350-B-DD, CO-350-COLD-B, CO-350-COLD-B-DD, CO-352-COLD-B, CO-352-COLD-B-DD, CO-400-B, CO-400-B-DD, CO-400-COLD-B, CO-400-COLD-B-DD, CO-402-COLD-B, CO-402-COLD-B-DD, CO-402W, CO-500B, CO-500BDD, CO-501B, CO-501BDD, CO-502B, CO-502BDD...(Other models you can see in the webshop) |                 |                     |



industrial hoses

Niplaflex hoses



|                    |   |                 |                        |
|--------------------|---|-----------------|------------------------|
| <b>GEV No.</b>     | 530561  | <b>Ref. No.</b> | 11000083<br>S102121000 |
| <b>description</b> | pressure hose ID $\varnothing$ 10mm ED $\varnothing$ 17mm L 5m thickness 3.5mm operating p. 10bar burst p. 30bar t.max. 110°C   |                 |                        |
| <b>For models:</b> | ACE-061, ACE-101, ACE-102, ACE-201, ACE-202, ACG-061, ACG-101, ACG-102, ACG-201, ACG-202, AD-120, AD-120B, AD-120BBTDD-UK, AD-120C, AD-120CW, AD-120HY, AD-125, AD-125HRS, AD-125-SOFT, AD-15, AD-15D, AD-20C-UK, AD-21, AD-21B, AD-21BDD, AD-21C, AD-21D, AD-21DD, AD-21W, AD-45BBT, AD-48, AD-48B, AD-48BDD, AD-48C, AD-48D, AD-48DD, AD-48HY, AD-48W, AD-505, AD-505-SOFT, AD-64, AD-64B, AD-64BBT, AD-64BDD, AD-64BTDD, AD-64C, AD-64CW, AD-64D, AD-64DD, AD-64HY...(Other models you can see in the webshop) |                 |                        |

pressure control hoses



|                    |  |                 |                     |
|--------------------|--|-----------------|---------------------|
| <b>GEV No.</b>     | 530560   | <b>Ref. No.</b> | 11000066<br>3702400 |
| <b>description</b> | pressure control hose ID $\varnothing$ 5mm ED $\varnothing$ 9mm L 5m operating p. 30bar burst p. 90bar temp.-resist. 60°C  |                 |                     |
| <b>For models:</b> | AD-120, AD-120B, AD-120BBTDD-UK, AD-120C, AD-120CW, AD-120HY, AD-125, AD-125HRS, AD-125-SOFT, AD-15, AD-15D, AD-20C-UK, AD-21, AD-21B, AD-21BDD, AD-21C, AD-21D, AD-21DD, AD-21W, AD-45BBT, AD-48, AD-48B, AD-48BDD, AD-48C, AD-48D, AD-48DD, AD-48HY, AD-48W, AD-505, AD-505-SOFT, AD-64, AD-64B, AD-64BBT, AD-64BDD, AD-64BTDD, AD-64C, AD-64CW, AD-64D, AD-64DD, AD-64HY, AD-72, AD-72W, AD-90, AD-90BA, AD-90BBT, AD-90BDD, AD-90DD, ADE-120, ADE-120B, CO-110...(Other models you can see in the webshop) |                 |                     |

silicone hoses

without fabric



|                    |   |                 |                                 |
|--------------------|---|-----------------|---------------------------------|
| <b>GEV No.</b>     | 520399  | <b>Ref. No.</b> | 11000157<br>11000158<br>3715600 |
| <b>description</b> | silicone hose ID $\varnothing$ 18mm ED $\varnothing$ 26mm thickness 4mm t.max. 200°C red  |                 |                                 |
| <b>For models:</b> | ACE-061, ACE-102, AE-061, AE-061W, AE-101, AE-101W, AE-102, AE-102W, AE-201, AE-202, AG-061, AG-061W, AG-101, AG-101W, AG-102, AG-102W, AG-201, AG-202, APE-061, APE-061W, APE-101, APE-101W, APE-102, APE-102W, APE-201, APE-202, APG-061, APG-061W, APG-101, APG-101W, APG-102, APG-102W, APG-201, APG-202, HCG-10-11, HCG-10-21, HCG-20-11, HCG-2-10-11, HCG-6-11, HEI-10-11, HEI-10-21, HEI-6-11, HEM-10-11, HEM-10-21, HEM-20-11, HEM-20-21, HEM-6-11, HEP-10-11, HEP-10-21, HEP-20-11...(Other models you can see in the webshop) |                 |                                 |

Зип Общепит

vsezip.ru

+7(812)987-08-81



|                    |  |                 |  |
|--------------------|--|-----------------|--|
| <b>GEV No.</b>     | 530052   | <b>Ref. No.</b> | 11000154<br>11000171<br>3710900<br>3715800<br>R345021<br>R345024 |
| <b>description</b> | silicone hose ID $\varnothing$ 43mm ED $\varnothing$ 51mm L 0.8m thickness 4mm t.max. 200°C red  |                 |  |
| <b>For models:</b> | COE-102, COG-061, COG-101, COG-102, COG-201, COG-202, HCV-10-11, HCV-10-21, HCV-2-10-21, HCV-5-11, HCV-6-11, HEI-10-11, HEI-10-21, HEI-20-11, HEI-20-21, HEI-6-11, HEM-10-11, HEM-10-21, HEM-20-11, HEM-20-21, HEM-6-11, HEP-10-11, HEP-10-21, HEP-20-11, HEP-20-21, HEP-6-11, HGP-10-21, HGV-20-21, HME-10-11, HME-10-21, HME-20-11, HME-20-21, HME-2-10-11, HME-2-20-11, HME-6-11, HMI-10-11, HMI-10-11UL, HMI-10-21, HMI-10-21UL, HMI-2-10-11, HMI-6-11, HMI-6-11UL, HMM-10-11, HMM-10-11UL, HMM-10-21, HMM-10-21UL, HMM-20-11, HMM-20-11UL, HMM-20-21, HMM-20-21UL...(Other models you can see in the webshop) |                 |  |



|                    |  |                 |                        |
|--------------------|--|-----------------|------------------------|
| <b>GEV No.</b>     | 530067   | <b>Ref. No.</b> | 12034862<br>RT21121301 |
| <b>description</b> | silicone hose ID $\varnothing$ 50mm ED $\varnothing$ 56mm L 0.13m thickness 3mm t.max. 200°C |                 |                        |



|                    |   |                 |                        |
|--------------------|---|-----------------|------------------------|
| <b>GEV No.</b>     | 530798  | <b>Ref. No.</b> | 12034250<br>RT21101030 |
| <b>description</b> | silicone hose ID $\varnothing$ 6mm ED $\varnothing$ 10mm L 1120mm for combi-steamer CPC-Linie CM 61-202/G |                 |                        |



|                    |   |                 |                        |
|--------------------|---|-----------------|------------------------|
| <b>GEV No.</b>     | 530550  | <b>Ref. No.</b> | 12034590<br>RT21101008 |
| <b>description</b> | silicone hose ID $\varnothing$ 6mm ED $\varnothing$ 10mm L 5m thickness 2mm operating pressure without pressure burst pressure non defined t.max. 200°C transparent Shore 55° |                 |                        |

water and beverage technology



Зип Общепит

vsezip.ru

+7(812)987-08-81

with fabric

with monofilament braid

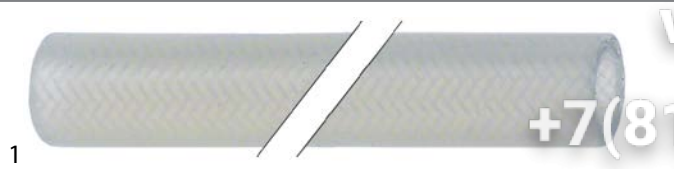

|                    |  |                 |                        |
|--------------------|--|-----------------|------------------------|
| <b>GEV No.</b>     | 530693   | <b>Ref. No.</b> | 12033361<br>RT20670050 |
| <b>description</b> | silicone hose with monofilament braid ID ø 10mm ED ø 17mm L 1m thickness 3.5mm operating p. 4bar t.max. 200°C Qty 1m |                 |                        |

pressure hoses (other)

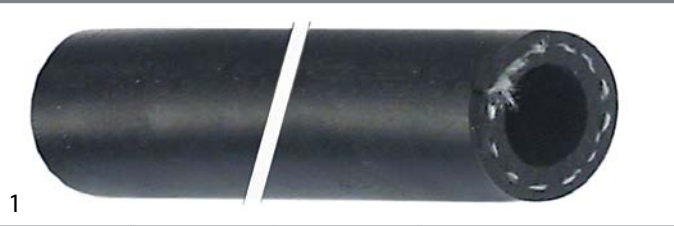

|                    |  |                 |                   |
|--------------------|--|-----------------|-------------------|
| <b>GEV No.</b>     | 530567   | <b>Ref. No.</b> | 36769<br>36769000 |
| <b>description</b> | universal hose ID ø 10mm ED ø 17mm Qty supplied by meter |                 |                   |

formed hoses

straight

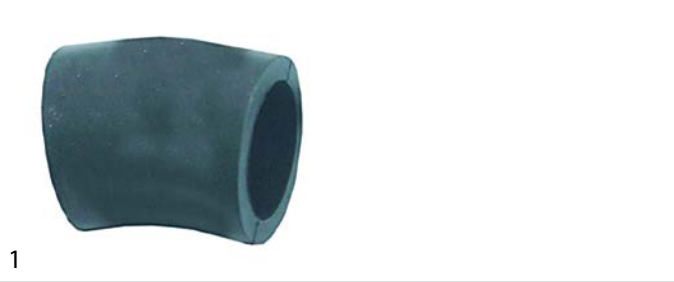

|                    |  |                 |                     |
|--------------------|--|-----------------|---------------------|
| <b>GEV No.</b>     | 505026   | <b>Ref. No.</b> | 12023607<br>Z400906 |
| <b>description</b> | formed hose dishwasher straight  |                 |                     |
| <b>For models:</b> | AD-15, AD-15D, AD-20C-UK, AD-21, AD-21B, AD-21BDD, AD-21C, AD-21D, AD-21DD, AD-21W, CO-350, CO-350-B, CO-350-B-DD, CO-350-COLD, CO-350-COLD-B, CO-350-COLD-B-DD, CO-350-COLD-DD, CO-350-DD, CO-352-COLD, CO-352-COLD-B, CO-352-COLD-B-DD, CO-352-COLD-DD, CO-400, CO-400-B, CO-400-B-DD, CO-400-COLD, CO-400-COLD-B, CO-400-COLD-B-DD, CO-400-COLD-DD, CO-400-DD, CO-400-SOFT, CO-402-COLD, CO-402-COLD-B, CO-402-COLD-B-DD, CO-402-COLD-DD, CO-402W, LVC-12, LVC-15, LVC-15D, LVC-21, LVC-21B, LVC-21C, LVC-21D, LVC-21W, LVR-10, LVR-14, LVR-14D, LVR-20, LVR-20B, LVR-20D...(Other models you can see in the webshop) |                 |                     |

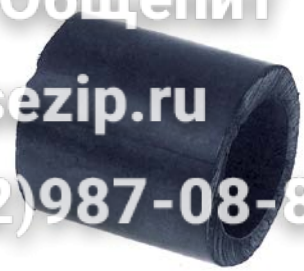

|                    |   |                 |  |
|--------------------|---|-----------------|--|
| <b>GEV No.</b>     | 503150  | <b>Ref. No.</b> | 12000050<br>12023567<br>Z162301<br>Z740902 |
| <b>description</b> | formed hose hose ext. ø 54mm hose int. ø 38mm L 55mm  |                 |  |
| <b>For models:</b> | AD-120BBTDD-UK, AD-120HY, AD-90, AD-90BA, AD-90BBT, AD-90BDD, AD-90DD, ADE-120, ADE-120B, ECO-120, ECO-120B, ECO-160, ECO-1600, ECO-160D, ECO-160I, ECO-200, ECO-200D, ECO-200H, ECO-200HD, ECO-200HI, ECO-200I, ECO-2300, ECO-2700D, ECO-2700I, ECO-280D, ECO-280I, ECO-3000, ECO-370D, ECO-370I, ECO-4000D, ECO-4000I, ECO-460D, ECO-460I, ECO-550D, ECO-550I, ECO-6000D, ECO-6000I, FI-100, FI-100AR, FI-100B, FI-100BBT-UK, FI-120HY-CLINIC, FI-2700D, FI-2700I, FI-280D, FI-280I, FI-370D, FI-370I, FI-4000D, FI-4000I...(Other models you can see in the webshop) |                 |  |



|                    |   |                 |          |
|--------------------|---|-----------------|----------|
| <b>GEV No.</b>     | 530880  | <b>Ref. No.</b> | 12024437 |
| <b>description</b> | formed hose hose int. ø 30.5mm D1 ø 39mm D2 ø 44.5mm L 45mm Qty 1 |                 |          |
| <b>For models:</b> | AD-64BTDD, EASY-500HPWBDD   |                 |          |



|                    |  |                 |                     |
|--------------------|--|-----------------|---------------------|
| <b>GEV No.</b>     | 530025   | <b>Ref. No.</b> | 12019517<br>R345020 |
| <b>description</b> | formed hose ID ø 51mm ED ø 62mm L 101mm straight steam   |                 |                     |
| <b>For models:</b> | HCV-10-11, HCV-10-21, HCV-2-10-21, HCV-5-11, HCV-6-11, HEI-10-11, HEI-10-21, HEI-20-11, HEI-6-11, HEM-10-11, HEM-10-21, HEM-20-11, HEM-6-11, HEP-10-11, HEP-10-21, HEP-20-11, HEP-6-11, HGP-20-21, HGV-20-21, HME-10-11, HME-10-21, HME-20-11, HME-20-21, HME-2-10-11, HME-2-20-11, HME-6-11, HMM-10-11, HMM-10-11UL, HMM-10-21, HMM-10-21UL, HMM-20-11, HMM-20-11UL, HMM-20-21, HMM-20-21UL, HMM-2-10-11, HMM-2-20-11, HMM-40-11-USMC, HMM-6-11, HMM-6-11UL, HMP-10-11, HMP-10-21, HMP-20-11, HMP-20-21, HMP-2-10-11, HMP-2-20-11, HMP-6-11, HVG-20-21, HVG-2-20-21 |                 |                     |

Зип Общепит

form 2

vsezip.ru

+7(812)987-08-81



1

|                    |   |                 |                     |
|--------------------|---|-----------------|---------------------|
| <b>GEV No.</b>     | 694706  | <b>Ref. No.</b> | 12024122<br>T722600 |
| <b>description</b> | hose ID ø 52mm ext. ø 57 L 363mm silicone discharge air steam generator red Qty 1   |                 |                     |
| <b>For models:</b> | ACE-061, ACE-101, ACE-102, ACE-201, ACE-202, ACG-061, ACG-101, ACG-102, ACG-201, ACG-202, AE-061, AE-061W, AE-101, AE-101W, AE-102, AE-102W, AE-201, AE-202, AG-061, AG-061W, AG-101, AG-101W, AG-102, AG-102W, AG-201, AG-202, APE-061, APE-061W, APE-101, APE-101W, APE-102, APE-102W, APE-201, APE-202, APG-061, APG-061W, APG-101, APG-101W, APG-102, APG-102W, APG-201, APG-202, COE-061, COE-101, COE-102, COE-201, COE-202, VE-061, VE-101, VE-102...(Other models you can see in the webshop) |                 |                     |



1

|                    |  |                 |                     |
|--------------------|--|-----------------|---------------------|
| <b>GEV No.</b>     | 505336   | <b>Ref. No.</b> | 12024143<br>Z310904 |
| <b>description</b> | extraction hose ED ø 76mm L 220mm L-shape ID ø 60mm for FAGOR  |                 |                     |
| <b>For models:</b> | ECO-2700D, ECO-2700I, ECO-280D, ECO-280I, ECO-370D, ECO-370I, ECO-4000D, ECO-4000I, ECO-460D, ECO-460I, ECO-550D, ECO-550I, ECO-6000D, ECO-6000I, FI-2700D, FI-2700I, FI-280D, FI-280I, FI-370D, FI-370I, FI-4000D, FI-4000I, FI-460D, FI-460I, FI-550D, FI-550I, FI-6000D, FI-6000I |                 |                     |



2

|                    |   |                 |                        |
|--------------------|---|-----------------|------------------------|
| <b>GEV No.</b>     | 694321  | <b>Ref. No.</b> | 12037987<br>RT21121307 |
| <b>description</b> | hose ID ø 70mm ext. ø 80 L 80mm for combi-steamer |                 |                        |



1

|                    |  |                 |                        |
|--------------------|--|-----------------|------------------------|
| <b>GEV No.</b>     | 524028   | <b>Ref. No.</b> | 12023698<br>12Z7409010 |
| <b>description</b> | formed hose 90° L2 120mm L1 190mm ID ø 38mm ED ø 54mm  |                 |                        |
| <b>For models:</b> | AD-120C, AD-120HY, AD-90, AD-90BA, AD-90BDD, AD-90DD, ECO-160D, ECO-160I, ECO-200D, ECO-200HD, ECO-200HI, ECO-200I, FI-160AR, FI-160D, FI-160I, FI-200AR, FI-200D, FI-200HD, FI-200HI, FI-200I, FI-200WL, FI-200WR, FI-80, FI-80AR, FI-80W, FI-E-100, LABP-800 |                 |                        |



1

|                    |  |                 |                        |
|--------------------|--|-----------------|------------------------|
| <b>GEV No.</b>     | 530067   | <b>Ref. No.</b> | 12034862<br>RT21121301 |
| <b>description</b> | silicone hose ID ø 50mm ED ø 56mm L 0.13m thickness 3mm t.max. 200°C |                 |                        |

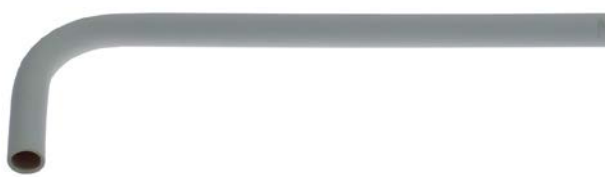

1

|                    |  |                 |                        |
|--------------------|--|-----------------|------------------------|
| <b>GEV No.</b>     | 530794   | <b>Ref. No.</b> | 12031663<br>RT21121304 |
| <b>description</b> | formed hose ED ø 29mm ID ø 23mm L 485mm for combi-steamer CPC-Linie 102/201E |                 |                        |



1

|                    |  |                 |                       |
|--------------------|--|-----------------|-----------------------|
| <b>GEV No.</b>     | 530875   | <b>Ref. No.</b> | 12031550<br>RT4400362 |
| <b>description</b> | steam hose ext. ø 78 ID ø 70mm L 54mm silicone red/black |                 |                       |



1

|                    |   |                 |                       |
|--------------------|---|-----------------|-----------------------|
| <b>GEV No.</b>     | 530791  | <b>Ref. No.</b> | 12031730<br>RT4400242 |
| <b>description</b> | formed hose ED ø 29mm ID ø 23mm L 730mm for combi-steamer SCC Linie 202 |                 |                       |



Зип Общепит

vsezip.ru

+7(812)987-08-81

|                    |  |                 |                     |
|--------------------|--|-----------------|---------------------|
|                    |  |                 |                     |
| <b>GEV No.</b>     | 505028   | <b>Ref. No.</b> | 12023639<br>Z200905 |
| <b>description</b> | formed hose end piece A int. ø 50mm ø end piece B 38mm L 250mm warewashing L-shape equiv. no. Z200905  |                 |                     |
| <b>For models:</b> | AD-45BBT, AD-48, AD-48B, AD-48BDD, AD-48C, AD-48D, AD-48DD, AD-48HY, AD-48W, AD-64, AD-64B, AD-64BBT, AD-64BDD, AD-64BTDD, AD-64C, AD-64CW, AD-64D, AD-64DD, AD-64HY, AD-72, AD-72W, EASY-500, EASY-500B, EASY-500DD, EASY-500HP, EASY-500HPWBDD, FI-30, FI-30AR, FI-30AR+DD, FI-30B, FI-30B-BT-UK, FI-30-UK, FI-48, FI-48AR, FI-48B, FI-48B-BT-UK, FI-48C, FI-48D, FI-48HY-CLINIC, FI-48W, FI-50, FI-60DD, FI-64, FI-64AR, FI-64B, FI-64B-BT-UK, FI-64C, FI-64D, FI-64HY-CLINIC, FI-64W...(Other models you can see in the webshop) |                 |                     |

|                    |  |                 |                     |
|--------------------|--|-----------------|---------------------|
|                    |  |                 |                     |
| <b>GEV No.</b>     | 505029   | <b>Ref. No.</b> | 12023741<br>Z710905 |
| <b>description</b> | formed hose warewashing L-shape equiv. no. Z710905 mounting pos. lower   |                 |                     |
| <b>For models:</b> | AD-120, AD-120B, AD-120BBTDD-UK, AD-120C, AD-120CW, AD-120HY, AD-90BBT, ADE-120, ADE-120B, ECO-120, ECO-120B, ECO-160, ECO-160D, ECO-160I, ECO-200, ECO-200D, ECO-200H, ECO-200HD, ECO-200HI, ECO-200I, ECO-2700D, ECO-2700I, ECO-370D, ECO-370I, ECO-4000D, ECO-4000I, ECO-550D, ECO-550I, ECO-6000D, ECO-6000I, FI-100, FI-100AR, FI-100B, FI-100BBT-UK, FI-120, FI-120AR+DD, FI-120B, FI-120C, FI-120HY-CLINIC, FI-120W, FI-160, FI-160AR, FI-160D, FI-160I, FI-200, FI-200AR, FI-200D, FI-200H, FI-200HD, FI-200HI...(Other models you can see in the webshop) |                 |                     |

|                    |   |                 |                        |
|--------------------|---|-----------------|------------------------|
|                    |   |                 |                        |
| <b>GEV No.</b>     | 530792  | <b>Ref. No.</b> | 12031089<br>RT21121305 |
| <b>description</b> | formed hose ID ø 22mm ED ø 29mm L 640mm for combi-steamer CPC 202 |                 |                        |

|                    |  |                 |                     |
|--------------------|--|-----------------|---------------------|
|                    |  |                 |                     |
| <b>GEV No.</b>     | 505030   | <b>Ref. No.</b> | 12023519<br>Z710906 |
| <b>description</b> | formed hose warewashing L-shape equiv. no. Z710906 mounting pos. upper   |                 |                     |
| <b>For models:</b> | AD-120, AD-120B, AD-120BBTDD-UK, AD-120C, AD-120CW, AD-120HY, AD-90BBT, ADE-120, ADE-120B, ECO-120, ECO-120B, ECO-160, ECO-160D, ECO-160I, ECO-200, ECO-200D, ECO-200H, ECO-200HD, ECO-200HI, ECO-200I, ECO-370D, ECO-370I, ECO-550D, ECO-550I, FI-100, FI-100AR, FI-100B, FI-100BBT-UK, FI-120, FI-120AR+DD, FI-120B, FI-120C, FI-120HY-CLINIC, FI-120W, FI-160, FI-160AR, FI-160D, FI-160I, FI-200, FI-200AR, FI-200D, FI-200H, FI-200HD, FI-200HI, FI-200I, FI-200W, FI-200WL, FI-200WR, FI-370D, FI-370I...(Other models you can see in the webshop) |                 |                     |

|                    |  |                 |                     |
|--------------------|--|-----------------|---------------------|
|                    |  |                 |                     |
| <b>GEV No.</b>     | 505024   | <b>Ref. No.</b> | 12023683<br>Z200904 |
| <b>description</b> | formed hose warewashing L-shape equiv. no. Z200904   |                 |                     |
| <b>For models:</b> | AD-45BBT, AD-48, AD-48B, AD-48BDD, AD-48C, AD-48D, AD-48DD, AD-48HY, AD-48W, AD-64, AD-64B, AD-64BBT, AD-64BDD, AD-64BTDD, AD-64C, AD-64CW, AD-64D, AD-64DD, AD-64HY, AD-72, AD-72W, EASY-500, EASY-500B, EASY-500DD, EASY-500HP, EASY-500HPWBDD, FI-30, FI-30AR, FI-30AR+DD, FI-30B, FI-30B-BT-UK, FI-30-UK, FI-48, FI-48AR, FI-48B, FI-48B-BT-UK, FI-48C, FI-48D, FI-48HY-CLINIC, FI-48W, FI-50, FI-60DD, FI-64, FI-64AR, FI-64B, FI-64B-BT-UK, FI-64C, FI-64D, FI-64HY-CLINIC, FI-64W...(Other models you can see in the webshop) |                 |                     |

|                    |   |                 |                     |
|--------------------|---|-----------------|---------------------|
|                    |   |                 |                     |
| <b>GEV No.</b>     | 505027  | <b>Ref. No.</b> | 12023625<br>Z710904 |
| <b>description</b> | formed hose warewashing L-shape equiv. no. Z740901  |                 |                     |
| <b>For models:</b> | AD-120, AD-120B, AD-120BBTDD-UK, AD-120C, AD-120CW, AD-120HY, AD-90, AD-90BA, AD-90BBT, AD-90BDD, AD-90DD, ADE-120, ADE-120B, ECO-120, ECO-120B, ECO-160, ECO-160D, ECO-160I, ECO-200, ECO-200D, ECO-200H, ECO-200HD, ECO-200HI, ECO-200I, ECO-370D, ECO-370I, ECO-550D, ECO-550I, FI-100, FI-100AR, FI-100B, FI-100BBT-UK, FI-120, FI-120AR+DD, FI-120B, FI-120C, FI-120HY-CLINIC, FI-120W, FI-160, FI-160AR, FI-160D, FI-160I, FI-200, FI-200AR, FI-200D, FI-200H, FI-200HD, FI-200HI, FI-200I, FI-200W...(Other models you can see in the webshop) |                 |                     |

|                    |  |                 |                     |
|--------------------|--|-----------------|---------------------|
|                    |  |                 |                     |
| <b>GEV No.</b>     | 505023   | <b>Ref. No.</b> | 12023670<br>Z400905 |
| <b>description</b> | formed hose warewashing L-shape equiv. no. Z400905   |                 |                     |
| <b>For models:</b> | AD-15, AD-15D, AD-20C-UK, AD-21, AD-21B, AD-21BDD, AD-21C, AD-21D, AD-21DD, AD-21W, CO-350, CO-350-B, CO-350-B-DD, CO-350-COLD, CO-350-COLD-B, CO-350-COLD-B-DD, CO-350-COLD-DD, CO-350-DD, CO-352-COLD, CO-352-COLD-B, CO-352-COLD-B-DD, CO-352-COLD-DD, CO-400, CO-400-B, CO-400-B-DD, CO-400-COLD, CO-400-COLD-B, CO-400-COLD-B-DD, CO-400-COLD-DD, CO-400-DD, CO-400-SOFT, CO-402-COLD, CO-402-COLD-B, CO-402-COLD-B-DD, CO-402-COLD-DD, CO-402W, LVC-12, LVC-15, LVC-15D, LVC-21, LVC-21B, LVC-21C, LVC-21D, LVC-21W, LVR-10, LVR-14, LVR-14D, LVR-20, LVR-20B, LVR-20D...(Other models you can see in the webshop) |                 |                     |

Зип.Общепит

maecanapcs

vsezip.ru

+7(812)987-08-81

|   |   |                 |                     |
|---|---|-----------------|---------------------|
|  |   |                 |                     |
| 1   |   |                 |                     |
| <b>GEV No.</b>  | 505032  | <b>Ref. No.</b> | 12023779<br>Z740903 |
| <b>description</b>  | formed hose warewashing L-shape equiv. no. Z740903 mounting pos. lower        |                 |                     |
| <b>For models:</b>  | AD-90, AD-90BA, AD-90BDD, AD-90DD, FI-80, FI-80AR, FI-80W, FI-E-100, LABP-800 |                 |                     |

|  |  |                 |                     |
|--|--|-----------------|---------------------|
|  |  |                 |                     |
| 1  |  |                 |                     |
| <b>GEV No.</b>   | 511557   | <b>Ref. No.</b> | 11000142<br>3715300 |
| <b>description</b>   | dosing hose ED ø 26mm ID ø 15mm L 1200mm burst p. 20bar  |                 |                     |
| <b>For models:</b>   | ECO-160, ECO-160D, ECO-160I, ECO-200, ECO-200D, ECO-200H, ECO-200HD, ECO-200HI, ECO-200I, ECO-2700D, ECO-2700I, ECO-280D, ECO-280I, ECO-370D, ECO-370I, ECO-4000D, ECO-4000I, ECO-460D, ECO-460I, ECO-550D, ECO-550I, ECO-6000D, ECO-6000I, FI-2700D, FI-2700I, FI-280D, FI-280I, FI-30B-BT-UK, FI-370D, FI-370I, FI-4000D, FI-4000I, FI-460D, FI-460I, FI-48B-BT-UK, FI-48HY-CLINIC, FI-550D, FI-550I, FI-6000D, FI-6000I, FI-64B-BT-UK, FI-64HY-CLINIC |                 |                     |

|   |   |                 |                        |
|---|---|-----------------|------------------------|
|  |   |                 |                        |
| 1   |   |                 |                        |
| <b>GEV No.</b>  | 530918  | <b>Ref. No.</b> | 12039649<br>T945056000 |
| <b>description</b>  | hose ID ø 30mm ED ø 40mm L 110mm for steam generator  |                 |                        |
| <b>For models:</b>  | ACE-102, AE-102, AE-102W, AE-201, AE-202, AG-061, AG-061W, AG-101, AG-101W, AG-102, AG-102W, AG-201, AG-202, APE-102, APE-102W, APE-201, APE-202, APG-061, APG-061W, APG-101, APG-101W, APG-102, APG-102W, APG-201, APG-202 |                 |                        |

|  |  |                 |                     |
|--|--|-----------------|---------------------|
|  |  |                 |                     |
| 1  |  |                 |                     |
| <b>GEV No.</b>   | 105503   | <b>Ref. No.</b> | 12023858<br>Z951101 |
| <b>description</b>   | extraction hose ED ø 35mm IT 1" L 970mm SS   |                 |                     |
| <b>For models:</b>   | ADE-120, ADE-120B, ECO-120, ECO-120B, ECO-160, ECO-1600, ECO-160D, ECO-160I, ECO-200, ECO-200D, ECO-200H, ECO-200HD, ECO-200HI, ECO-200I, ECO-2300, ECO-2700D, ECO-2700I, ECO-280D, ECO-280I, ECO-3000, ECO-370D, ECO-370I, ECO-4000D, ECO-4000I, ECO-460D, ECO-460I, ECO-550D, ECO-550I, ECO-6000D, ECO-6000I, GA-20, GA-20D, GA-40, GA-40D |                 |                     |

|  |  |                 |          |
|--|--|-----------------|----------|
|  |  |                 |          |
| 1  |  |                 |          |
| <b>GEV No.</b>   | 530919   | <b>Ref. No.</b> | 12044832 |
| <b>description</b>   | hose ID ø 73mm ED ø 85mm L 150mm for steam generator |                 |          |
| <b>For models:</b>   | AG-202, APG-202                                      |                 |          |

|   |  |                 |                     |
|---|--|-----------------|---------------------|
|  |  |                 |                     |
| 1   |  |                 |                     |
| <b>GEV No.</b>  | 505336   | <b>Ref. No.</b> | 12024143<br>Z310904 |
| <b>description</b>  | extraction hose ED ø 76mm L 220mm L-shape ID ø 60mm for FAGOR  |                 |                     |
| <b>For models:</b>  | ECO-2700D, ECO-2700I, ECO-280D, ECO-280I, ECO-370D, ECO-370I, ECO-4000D, ECO-4000I, ECO-460D, ECO-460I, ECO-550D, ECO-550I, ECO-6000D, ECO-6000I, FI-2700D, FI-2700I, FI-280D, FI-280I, FI-370D, FI-370I, FI-4000D, FI-4000I, FI-460D, FI-460I, FI-550D, FI-550I, FI-6000D, FI-6000I |                 |                     |

for dishwashers

pressure hoses

|   |  |                 |          |
|---|--|-----------------|----------|
|  |  |                 |          |
| 1   |  |                 |          |
| <b>GEV No.</b>  | 513136   | <b>Ref. No.</b> | 11000070 |
| <b>description</b>  | pressure hose ext. ø 10 ID ø 4.5mm L 1000mm dosage black Qty 1 rinse aid   |                 |          |
| <b>For models:</b>  | AD-120, AD-120B, AD-120BBTDD-UK, AD-120C, AD-120CW, AD-120HY, AD-15, AD-15D, AD-20C-UK, AD-21, AD-21B, AD-21BDD, AD-21C, AD-21D, AD-21DD, AD-21W, AD-48, AD-48B, AD-48BDD, AD-48C, AD-48D, AD-48DD, AD-48W, AD-64, AD-64B, AD-64BDD, AD-64C, AD-64CW, AD-64D, AD-64DD, AD-72, AD-72W, AD-90, AD-90BA, AD-90BBT, AD-90BDD, AD-90DD, ADE-120, ADE-120B, CO-110, CO-110B, CO-110BDD, CO-110DD, CO-112, CO-112B, CO-112BDD, CO-112DD, CO-142W, CO-142WDD, CO-170...(Other models you can see in the webshop) |                 |          |

accessories

|  |   |                 |                     |
|--|---|-----------------|---------------------|
|  |   |                 |                     |
| 1  |   |                 |                     |
| <b>GEV No.</b>   | 520053  | <b>Ref. No.</b> | 12025278<br>Z701132 |
| <b>description</b>   | screen connection 3/4" D1 ø 26mm D2 ø 15mm Qty 10 pcs rubber thickness 8mm  |                 |                     |
| <b>For models:</b>   | FI-100, FI-100AR, FI-100B, FI-120, FI-1200, FI-120B, FI-120W, FI-30, FI-300B, FI-300R, FI-48, FI-48B, FI-48W, FI-50, FI-64, FI-64B, FI-64W, FI-650R, FI-72, FI-80, FI-80W, FI-900, GA-20, GA-20D, GA-40, GA-40D, HCG-10-11, HCG-10-21, HCG-20-11, HCG-20-21, HCG-2-10-11, HCG-2-20-11, HCG-6-11, HCV-10-11, HCV-10-21, HCV-2-10-21, HCV-5-11, HCV-6-11, HEI-10-11, HEI-10-21, HEI-2-10-11, HEI-5-11, HEI-6-11, HEI-10-11, HEI-10-21, HEI-20-11, HEI-20-21, HEI-6-11, HEM-10-11, HEM-10-21...(Other models you can see in the webshop) |                 |                     |





fittings, hose and pipe connectors

hose connectors

without screw connection



|                    |   |                 |                     |
|--------------------|---|-----------------|---------------------|
| <b>GEV No.</b>     | 505088  | <b>Ref. No.</b> | 12023511<br>Z201106 |
| <b>description</b> | Y-piece plastic hose ø 12-12-12mm L 75mm  |                 |                     |
| <b>For models:</b> | AD-120, AD-120B, AD-120C, AD-120CW, AD-125, AD-125HRS, AD-125-SOFT, AD-45BBT, AD-48, AD-48B, AD-48BD, AD-48C, AD-48D, AD-48DD, AD-48HY, AD-48W, AD-64, AD-64B, AD-64BD, AD-64BDD, AD-64BTDD, AD-64C, AD-64CW, AD-64D, AD-64DD, AD-64HY, AD-72, AD-72W, AD-90, AD-90BA, AD-90BDD, AD-90DD, ADE-120, ADE-120B, CO-110, CO-110B, CO-110BDD, CO-110DD, CO-112, CO-112B, CO-112BDD, CO-112DD, CO-142W, CO-142WDD, CO-170, CO-170B, CO-170BDD, CO-170DD, CO-170HRS, CO-170HRSDD...(Other models you can see in the webshop) |                 |                     |



|                    |   |                 |                     |
|--------------------|---|-----------------|---------------------|
| <b>GEV No.</b>     | 541109  | <b>Ref. No.</b> | 12023510<br>Z103077 |
| <b>description</b> | Y-piece plastic hose ø 8-6-8mm for pressure switch  |                 |                     |
| <b>For models:</b> | AD-120B, AD-120BBTDD-UK, AD-120C, AD-120HY, AD-45BBT, AD-48B, AD-48BDD, AD-48C, AD-48HY, AD-48W, AD-64B, AD-64BBT, AD-64BDD, AD-64BTDD, AD-64C, AD-64CW, AD-64HY, AD-72W, AD-90BA, AD-90BBT, AD-90BDD, ADE-120B, CO-500, CO-500B, CO-500BDD, CO-500DD, CO-501, CO-501B, CO-501BDD, CO-501DD, CO-501-SOFT, CO-502B, CO-502BDD, CO-502DD, CO-502W, COP-503, COP-503B, COP-503BDD, COP-503DD, COP-503-SOFT, COP-504, COP-504B, COP-504BDD, COP-504DD, COP-504W, EASY-500B, EASY-500HPWBDD, ECO-120B, ECO-160, ECO-1600...(Other models you can see in the webshop) |                 |                     |

Зип Общепит  
vsezip.ru  
+7(812)987-08-81

|                    |  |                 |                     |
|--------------------|--|-----------------|---------------------|
| <b>GEV No.</b>     | 505086   | <b>Ref. No.</b> | 12025288<br>Z601157 |
| <b>description</b> | T-piece connection 1: 10mm connection 2: 4mm   |                 |                     |
| <b>For models:</b> | AD-120, AD-120B, AD-120C, AD-120CW, AD-125, AD-125HRS, AD-15, AD-15D, AD-20C-UK, AD-21, AD-21B, AD-21BDD, AD-21C, AD-21D, AD-21DD, AD-21W, AD-48, AD-48B, AD-48BDD, AD-48C, AD-48D, AD-48DD, AD-48W, AD-64, AD-64B, AD-64BDD, AD-64C, AD-64CW, AD-64D, AD-64DD, AD-72, AD-72W, AD-90, AD-90BA, AD-90BDD, AD-90DD, ADE-120, ADE-120B, CO-110, CO-110B, CO-110BDD, CO-110DD, CO-112, CO-112B, CO-112BDD, CO-112DD, CO-142W, CO-142WDD, CO-170, CO-170B...(Other models you can see in the webshop) |                 |                     |

|                    |   |                 |                     |
|--------------------|---|-----------------|---------------------|
| <b>GEV No.</b>     | 505087  | <b>Ref. No.</b> | 12024192<br>Z401108 |
| <b>description</b> | cross fitting   |                 |                     |
| <b>For models:</b> | AD-15, AD-15D, AD-20C-UK, AD-21, AD-21B, AD-21BDD, AD-21C, AD-21D, AD-21DD, AD-21W, CO-350-COLD, CO-350-COLD-B, CO-350-COLD-B-DD, CO-350-COLD-DD, CO-352-COLD, CO-352-COLD-B, CO-352-COLD-B-DD, CO-352-COLD-DD, CO-400-COLD, CO-400-COLD-B, CO-400-COLD-B-DD, CO-400-COLD-DD, CO-402-COLD, CO-402-COLD-B, CO-402-COLD-B-DD, CO-402-COLD-DD, LVC-15, LVC-15D, LVC-21, LVC-21B, LVC-21C, LVC-21D, LVC-21W, LVR-14, LVR-14D, LVR-20, LVR-20B, LVR-20D, MF-21 |                 |                     |

fittings

double nipples

|                    |   |                 |  |
|--------------------|---|-----------------|--|
| <b>GEV No.</b>     | 520169  | <b>Ref. No.</b> | 12023958<br>12024396<br>Z102301<br>Z209509 |
| <b>description</b> | double nipple brass thread 3/4" - 3/4" Qty 1 pcs  |                 |  |
| <b>For models:</b> | AD-120CW, BME7-05, BME7-10, BMG7-10, CO-142W, CO-142WDD, ECO-120, ECO-1200, ECO-120B, ECO-160, ECO-1600, ECO-200, ECO-200H, ECO-2300, ECO-3000, FI-100, FI-100AR, FI-100B, FI-120, FI-1200, FI-120B, FI-120W, FI-160, FI-1600, FI-160AR, FI-160D, FI-160I, FI-200, FI-200AR, FI-200D, FI-200H, FI-200HD, FI-200HI, FI-200I, FI-200W, FI-200WL, FI-200WR, FI-2300, FI-2700D, FI-2700I, FI-280D, FI-280I, FI-30, FI-3000, FI-30AR, FI-30AR+DD, FI-30-UK, FI-370D, FI-370I, FI-4000D...(Other models you can see in the webshop) |                 |  |

water and beverage technology



water and beverage technology

Зип.Общедит

product specific

vsezip.ru

+7(812)987-08-81

T-pieces

miscellaneous



|                    |  |                 |                     |
|--------------------|--|-----------------|---------------------|
| <b>GEV No.</b>     | 520456   | <b>Ref. No.</b> | 12009162<br>S205022 |
| <b>description</b> | T-piece  |                 |                     |
| <b>For models:</b> | ME7-10BM, ME9-10BM, ME9-10BMS, ME9-15BM, ME9-15BM316, ME9-15BMS, MG7-10, MG7-10BM, MG9-10, MG-9100, MG9-10BM, MG9-10BMS, MG9-10S, MG9-15, MG-9150, MG-9150BM, MG9-15BM, MG9-15BM316, MG9-15BMS, MG9-15S, MG9-20, MG-9200, MG9-20S, MPE9-10BM, MPE9-10BMS, MPE9-15BM, MPE9-15BMS, MPG9-10, MPG9-10BM, MPG9-10BMS, MPG9-10S, MPG9-15, MPG-9150, MPG9-15BM, MPG9-15BMS, MPG9-15S, MPG9-20, MPG-9200, MPG9-20S |                 |                     |

hose connectors

plastic



|                    |   |                 |                        |
|--------------------|---|-----------------|------------------------|
| <b>GEV No.</b>     | 361100  | <b>Ref. No.</b> | 12036489<br>RT20620351 |
| <b>description</b> | hose connector plastic straight thread M10x1 hose ø 6mm Qty 1 pcs connection M10x1 hose ø 6mm |                 |                        |



|                    |   |                 |                        |
|--------------------|---|-----------------|------------------------|
| <b>GEV No.</b>     | 361102  | <b>Ref. No.</b> | 12036243<br>RT20620339 |
| <b>description</b> | hose connector plastic angled thread M10x1 hose ø 6mm Qty 1 pcs connection M10x1 hose ø 6mm |                 |                        |

brass



|                    |  |                 |                     |
|--------------------|--|-----------------|---------------------|
| <b>GEV No.</b>     | 505323   | <b>Ref. No.</b> | 12023772<br>Z102309 |
| <b>description</b> | hose connector brass straight thread 3/4" hose ø 10mm Qty 1 pcs  |                 |                     |
| <b>For models:</b> | ECO-1600, ECO-2300, ECO-280D, ECO-280I, ECO-3000, ECO-370D, ECO-370I, ECO-460D, ECO-460I, ECO-550D, ECO-550I, FI-1600, FI-200W, FI-200WL, FI-200WR, FI-2300, FI-280D, FI-280I, FI-3000, FI-370D, FI-370I, FI-460D, FI-460I, FI-550D, FI-550I |                 |                     |



|                    |   |                 |   |
|--------------------|---|-----------------|---|
| <b>GEV No.</b>     | 505262  | <b>Ref. No.</b> | 12018650<br>12019642<br>12024428<br>Z208914<br>Z230902<br>Z230905 |
| <b>description</b> | duct thread M12x1.75 for hose ID 4mm SS   |                 |   |
| <b>For models:</b> | AD-120C, AD-120HY, AD-20C-UK, AD-21B, AD-21BDD, AD-21C, AD-21DD, AD-21W, AD-45BBT, AD-48B, AD-48BDD, AD-48C, AD-48DD, AD-48HY, AD-48W, AD-64B, AD-64BBT, AD-64BDD, AD-64C, AD-64CW, AD-64DD, AD-64HY, AD-90BBT, AD-90BDD, AD-90DD, ECO-120, ECO-1200, FI-100, FI-100AR, FI-100BBT-UK, FI-120, FI-1200, FI-120AR+DD, FI-120C, FI-120HY-CLINIC, FI-120W, FI-30, FI-30AR, FI-30AR+DD, FI-30B, FI-30B-BT-UK, FI-30-UK, FI-48, FI-48AR, FI-48B, FI-48B-BT-UK, FI-48C, FI-48D, FI-48HY-CLINIC, FI-48W...(Other models you can see in the webshop) |                 |   |



|                    |   |                 |                     |
|--------------------|---|-----------------|---------------------|
| <b>GEV No.</b>     | 505133  | <b>Ref. No.</b> | 12023967<br>Z701104 |
| <b>description</b> | hose connector for hose ID 38-11mm brass  |                 |                     |
| <b>For models:</b> | AD-120BBTDD-UK, AD-120HY, AD-90BBT, ADE-120, ADE-120B, ECO-120, ECO-1200, ECO-120B, ECO-1600, ECO-2300, ECO-3000, FI-100, FI-100AR, FI-100B, FI-100BBT-UK, FI-120HY-CLINIC, FI-80BBT-UK |                 |                     |



|                    |  |                 |                      |
|--------------------|--|-----------------|----------------------|
| <b>GEV No.</b>     | 505236   | <b>Ref. No.</b> | 12023983<br>Z2819010 |
| <b>description</b> | hose connector grommet ø 13mm ID ø 11mm grommet length 18mm WS 32 total length 51mm thread L 17mm  |                 |                      |
| <b>For models:</b> | ECO-160D, ECO-160I, ECO-200D, ECO-200HD, ECO-200HI, ECO-200I, ECO-2700D, ECO-2700I, ECO-280D, ECO-280I, ECO-370D, ECO-370I, ECO-4000D, ECO-4000I, ECO-460D, ECO-460I, ECO-550D, ECO-550I, ECO-6000D, ECO-6000I, FI-2700D, FI-2700I, FI-280D, FI-280I, FI-370D, FI-370I, FI-4000D, FI-4000I, FI-460D, FI-460I, FI-550D, FI-550I, FI-6000D, FI-6000I |                 |                      |



Зип Общепит  
valves and tank inlets

ball valves  
universal

ball valves with lever handle

|   |  |                 |                     |
|---|--|-----------------|---------------------|
|  |  |                 |                     |
| 1   |  |                 |                     |
| <b>GEV No.</b>  | 361840   | <b>Ref. No.</b> | 12024395<br>Z711904 |
| <b>description</b>  | hose connector thread M20x2.5 5/8" pipe (22.7mm) grommet ø 11.5mm ID ø chrome-plated brassmm grommet length 20mm total length 52mm thread L 31mm T2: 5/8" pipe (22.7mm)  |                 |                     |
| <b>For models:</b>  | AD-120, AD-120B, AD-120BBTDD-UK, AD-120C, AD-120CW, AD-120HY, AD-90, AD-90BA, AD-90BBT, AD-90BDD, AD-90DD, ADE-120, ADE-120B, ECO-120, ECO-120B, FI-100, FI-100AR, FI-100B, FI-100BBT-UK, FI-120, FI-120AR+DD, FI-120B, FI-120C, FI-120HY-CLINIC, FI-120W, FI-160AR, FI-200AR, FI-280D, FI-280I, FI-370D, FI-370I, FI-460D, FI-460I, FI-550D, FI-550I, FI-80, FI-80AR, FI-80BBT-UK, FI-80W, FI-E-100, LABP-1000, LABP-1200, LABP-800, MF-120 |                 |                     |
| <b>accessories for</b>  | 361840   |                 |                     |
|  |  |                 |                     |
| <b>GEV No.</b>  | 507534   | <b>Ref. No.</b> | 12009819<br>Q223107 |
| <b>description</b>  | nut thread M20x2.5 WS 24 SS Qty 1 pcs H 13mm for pipe ø 12mm   |                 |                     |

|  |  |                 |                     |
|--|--|-----------------|---------------------|
|  |  |                 |                     |
| 1  |  |                 |                     |
| <b>GEV No.</b>   | 514325   | <b>Ref. No.</b> | 12009231<br>X036107 |
| <b>description</b>   | ball valve connection 1" IT - 1" IT DN25 total length 83mm with lever handle |                 |                     |

producer-specific

TMM

|   |  |                 |                        |
|---|--|-----------------|------------------------|
|  |  |                 |                        |
| 1   |  |                 |                        |
| <b>GEV No.</b>  | 512517   | <b>Ref. No.</b> | 12018487<br>T325063000 |
| <b>description</b>  | manifold thread 3/4" IT - 3/4" ET - 3/4" ET 3-way plastic suitable for combi-steamer FAGOR |                 |                        |

|  |   |                 |                                   |
|--|---|-----------------|-----------------------------------|
|  |   |                 |                                   |
| 1  |   |                 |                                   |
| <b>GEV No.</b>   | 514532  | <b>Ref. No.</b> | 12009691<br>R015034<br>R015034000 |
| <b>description</b>   | ball valve inlet 3/8" IT outlet 3/8" IT L 54.5mm H 82mm |                 |                                   |

|   |  |                 |                     |
|---|--|-----------------|---------------------|
|  |  |                 |                     |
| 1   |  |                 |                     |
| <b>GEV No.</b>  | 507534   | <b>Ref. No.</b> | 12009819<br>Q223107 |
| <b>description</b>  | nut thread M20x2.5 WS 24 SS Qty 1 pcs H 13mm for pipe ø 12mm   |                 |                     |
| <b>For models:</b>  | AD-120, AD-120B, AD-120BBTDD-UK, AD-120C, AD-120CW, AD-120HY, AD-90, AD-90BA, AD-90BBT, AD-90BDD, AD-90DD, ADE-120, ADE-120B, ECO-120, ECO-120B, FI-100, FI-100AR, FI-100B, FI-100BBT-UK, FI-120, FI-120AR+DD, FI-120B, FI-120C, FI-120HY-CLINIC, FI-120W, FI-160AR, FI-200AR, FI-280D, FI-280I, FI-370D, FI-370I, FI-460D, FI-460I, FI-550D, FI-550I, FI-80, FI-80AR, FI-80BBT-UK, FI-80W, FI-E-100, LABP-1000, LABP-1200, LABP-800, MF-120 |                 |                     |

shut-off valves

universal

|   |  |                 |                        |
|---|--|-----------------|------------------------|
|  |  |                 |                        |
| 1   |  |                 |                        |
| <b>GEV No.</b>  | 698612   | <b>Ref. No.</b> | 12034095<br>RT86641300 |
| <b>description</b>  | T-piece thread 3/4" ET - 1/2" ET - 3/4" IT plastic |                 |                        |

|   |   |                 |                     |
|---|---|-----------------|---------------------|
|  |   |                 |                     |
| 1   |   |                 |                     |
| <b>GEV No.</b>  | 514085  | <b>Ref. No.</b> | 12009132<br>S012102 |
| <b>description</b>  | rosette connection 26x19G chrome-plated total lengthmm mounting pos.  |                 |                     |
| <b>For models:</b>  | BME9-05, BME9-05AD, BME9-05PLUS, BME9-05V-T, BME9-10, BME9-10AD, BME9-10PLUS, BME9-10V-T, BMG9-05, BMG9-05V-T, BMG9-10, BMG9-10V-T, CPE7-05, CPE7-05NC, CPE9-05, CPE9-05S, CPG7-05, CPG7-05NC, CPG9-05, CPG9-05S, EPC-350, GPC-350, ME9-10BM, ME9-10BMS, ME9-15BM, ME9-15BM316, ME9-15BMS, MG9-10, MG9-10BM, MG9-10BMS, MG9-10S, MG9-15, MG9-15BM, MG9-15BM316, MG9-15BMS, MG9-15S, MG9-20, MG9-20S, MPE9-10BM, MPE9-10BMS, MPE9-15BM, MPE9-15BMS, MPG9-10, MPG9-10BM, MPG9-10BMS, MPG9-10S, MPG9-15, MPG9-15BM, MPG9-15BMS, MPG9-15S...(Other models you can see in the webshop) |                 |                     |

Зип Общепит

vsezip.ru

+7(812)987-08-81



|                |        |                 |                     |
|----------------|--------|-----------------|---------------------|
| <b>GEV No.</b> | 693107 | <b>Ref. No.</b> | 12039149<br>S112151 |
|----------------|--------|-----------------|---------------------|

**description** shut-off valve connection 1/2" 1/2" cold total length 54mm L1 27mm L2 30mm marking blue rosette thread G2 26x19G connection ø M4x0.7 ITmm

**For models:** BME7-05, BME7-10, BME9-05, BME9-10, BMG7-10, BMG9-05, BMG9-10, CPG7-05, CPG9-05, CPG9-05NC, CPG9-05S, CPG9-05SNC, ME7-10BM, ME9-10BM, ME9-10BMS, ME9-15BM, ME9-15BMS, MG7-10, MG7-10BM, MG9-10, MG9-10BM, MG9-10BMS, MG9-10S, MG9-15, MG9-15BM, MG9-15BMS, MG9-15S, MG9-20, MG9-20S, MPE9-10BM, MPE9-10BMS, MPE9-15BM, MPE9-15BMS, MPG9-10, MPG9-10BM, MPG9-10BMS, MPG9-10S, MPG9-15, MPG9-15BM, MPG9-15BMS, MPG9-15S, MPG9-20, MPG9-20S, SBE7-10, SBE9-10, SBE9-10I, SBE9-10IM, SBE9-10IMS, SBE9-10IS, SBE9-10M...(Other models you can see in the webshop)

**spare parts for** 693107

|   |                |        |                 |                     |
|---|----------------|--------|-----------------|---------------------|
|  | <b>GEV No.</b> | 514085 | <b>Ref. No.</b> | 12009132<br>S012102 |
|---|----------------|--------|-----------------|---------------------|

rosette connection 26x19G chrome-plated total lengthmm mounting pos.

|   |                |        |                 |   |
|---|----------------|--------|-----------------|---|
|  | <b>GEV No.</b> | 514086 | <b>Ref. No.</b> | — |
|---|----------------|--------|-----------------|---|

hexagonal nut connection 26x19G brass total lengthmm mounting pos. H 6mm WS 34 Qty 1 pcs

|   |                |        |                 |   |
|---|----------------|--------|-----------------|---|
|  | <b>GEV No.</b> | 540672 | <b>Ref. No.</b> | — |
|---|----------------|--------|-----------------|---|

gasket suitable for tap head

|   |                |        |                 |   |
|---|----------------|--------|-----------------|---|
|  | <b>GEV No.</b> | 547711 | <b>Ref. No.</b> | — |
|---|----------------|--------|-----------------|---|

hood handle shaft intake ø 8mm marking blue metal H2 21mm D1 ø 33mm type D suitable for MONOLITH shaft length H1 8mm

|   |                |        |                 |   |
|---|----------------|--------|-----------------|---|
|  | <b>GEV No.</b> | 548168 | <b>Ref. No.</b> | — |
|---|----------------|--------|-----------------|---|

star handle connection hot total lengthmm mounting pos. ø 57mm marking red

|   |                |        |                 |                     |
|---|----------------|--------|-----------------|---------------------|
|  | <b>GEV No.</b> | 548169 | <b>Ref. No.</b> | 12019545<br>S012104 |
|---|----------------|--------|-----------------|---------------------|

star handle connection cold total lengthmm mounting pos. chrome-plated ø 57mm

|   |                |        |                 |   |
|---|----------------|--------|-----------------|---|
| <b>accessories for</b>  | 693107         |        |                 |   |
|  | <b>GEV No.</b> | 514086 | <b>Ref. No.</b> | — |

hexagonal nut connection 26x19G brass total lengthmm mounting pos. H 6mm WS 34 Qty 1 pcs



|                |        |                 |                     |
|----------------|--------|-----------------|---------------------|
| <b>GEV No.</b> | 548169 | <b>Ref. No.</b> | 12019545<br>S012104 |
|----------------|--------|-----------------|---------------------|

**description** star handle connection cold total lengthmm mounting pos. chrome-plated ø 57mm



|                |        |                 |                     |
|----------------|--------|-----------------|---------------------|
| <b>GEV No.</b> | 514085 | <b>Ref. No.</b> | 12009132<br>S012102 |
|----------------|--------|-----------------|---------------------|

**description** rosette connection 26x19G chrome-plated total lengthmm mounting pos.

**For models:** BME9-05, BME9-05AD, BME9-05PLUS, BME9-05V-T, BME9-10, BME9-10AD, BME9-10PLUS, BME9-10V-T, BMG9-05, BMG9-05V-T, BMG9-10, BMG9-10V-T, CPE7-05, CPE7-05NC, CPE9-05, CPE9-05S, CPG7-05, CPG7-05NC, CPG9-05, CPG9-05S, EPC-350, GPC-350, ME9-10BM, ME9-10BMS, ME9-15BM, ME9-15BM316, ME9-15BMS, MG9-10, MG9-10BM, MG9-10BMS, MG9-10S, MG9-15, MG9-15BM, MG9-15BM316, MG9-15BMS, MG9-15S, MG9-20, MG9-20S, MPE9-10BM, MPE9-10BMS, MPE9-15BM, MPE9-15BMS, MPG9-10, MPG9-10BM, MPG9-10BMS, MPG9-10S, MPG9-15, MPG9-15BM, MPG9-15BMS, MPG9-15S...(Other models you can see in the webshop)



|                |        |                 |                     |
|----------------|--------|-----------------|---------------------|
| <b>GEV No.</b> | 540415 | <b>Ref. No.</b> | 12009120<br>S102109 |
|----------------|--------|-----------------|---------------------|

**description** star handle connection cold total lengthmm mounting pos. shaft diameter 7x7mm ø 55mm 35 built-in depth 22mm

**For models:** BME9-05, BME9-05AD, BME9-05PLUS, BME9-05V-T, BME9-10, BME9-10AD, BME9-10PLUS, BME9-10V-T, BMG9-05, BMG9-05V-T, BMG9-10, BMG9-10V-T, CPE7-05, CPE7-05NC, CPE9-05, CPE9-05S, CPG7-05, CPG7-05NC, CPG9-05, CPG9-05S, EPC-350, GPC-350, ME9-10BM, ME9-10BMS, ME9-15BM, ME9-15BM316, ME9-15BMS, MG9-10, MG9-10BM, MG9-10BMS, MG9-10S, MG9-15, MG9-15BM, MG9-15BM316, MG9-15BMS, MG9-15S, MG9-20, MG9-20S, MPE9-10BM, MPE9-10BMS, MPE9-15BM, MPE9-15BMS, MPG9-10, MPG9-10BM, MPG9-10BMS, MPG9-10S, MPG9-15, MPG9-15BM, MPG9-15BMS, MPG9-15S...(Other models you can see in the webshop)



|                |        |                 |                     |
|----------------|--------|-----------------|---------------------|
| <b>GEV No.</b> | 514085 | <b>Ref. No.</b> | 12009132<br>S012102 |
|----------------|--------|-----------------|---------------------|

**description** rosette connection 26x19G chrome-plated total lengthmm mounting pos.

**For models:** BME9-05, BME9-05AD, BME9-05PLUS, BME9-05V-T, BME9-10, BME9-10AD, BME9-10PLUS, BME9-10V-T, BMG9-05, BMG9-05V-T, BMG9-10, BMG9-10V-T, CPE7-05, CPE7-05NC, CPE9-05, CPE9-05S, CPG7-05, CPG7-05NC, CPG9-05, CPG9-05S, EPC-350, GPC-350, ME9-10BM, ME9-10BMS, ME9-15BM, ME9-15BM316, ME9-15BMS, MG9-10, MG9-10BM, MG9-10BMS, MG9-10S, MG9-15, MG9-15BM, MG9-15BM316, MG9-15BMS, MG9-15S, MG9-20, MG9-20S, MPE9-10BM, MPE9-10BMS, MPE9-15BM, MPE9-15BMS, MPG9-10, MPG9-10BM, MPG9-10BMS, MPG9-10S, MPG9-15, MPG9-15BM, MPG9-15BMS, MPG9-15S...(Other models you can see in the webshop)



Зип Общепит

vsezip.ru

+7(812)987-08-81

producer-specific

FAGOR



1

|                    |   |                 |                     |
|--------------------|---|-----------------|---------------------|
| <b>GEV No.</b>     | 514085  | <b>Ref. No.</b> | 12009132<br>S012102 |
| <b>description</b> | rosette connection 26x19G chrome-plated total lengthmm mounting pos.  |                 |                     |
| <b>For models:</b> | BME9-05, BME9-05AD, BME9-05PLUS, BME9-05V-T, BME9-10, BME9-10AD, BME9-10PLUS, BME9-10V-T, BMG9-05, BMG9-05V-T, BMG9-10, BMG9-10V-T, CPE7-05, CPE7-05NC, CPE9-05, CPE9-05S, CPG7-05, CPG7-05NC, CPG9-05, CPG9-05S, EPC-350, GPC-350, ME9-10BM, ME9-10BMS, ME9-15BM, ME9-15BM316, ME9-15BMS, MG9-10, MG9-10BM, MG9-10BMS, MG9-10S, MG9-15, MG9-15BM, MG9-15BM316, MG9-15BMS, MG9-15S, MG9-20, MG9-20S, MPE9-10BM, MPE9-10BMS, MPE9-15BM, MPE9-15BMS, MPG9-10, MPG9-10BM, MPG9-10BMS, MPG9-10S, MPG9-15, MPG9-15BM, MPG9-15BMS, MPG9-15S...(Other models you can see in the webshop) |                 |                     |



1





|                    |   |                 |                     |
|--------------------|---|-----------------|---------------------|
| <b>GEV No.</b>     | 514000  | <b>Ref. No.</b> | 12009294<br>S102111 |
| <b>description</b> | shut-off valve connection 1/2" 1/2" straight total length 54mm square 7x7mm mounting thread 26x19G  |                 |                     |
| <b>For models:</b> | BME9-05, BME9-05AD, BME9-05PLUS, BME9-05V-T, BME9-10, BME9-10AD, BME9-10PLUS, BME9-10V-T, BMG9-05, BMG9-05V-T, BMG9-10, BMG9-10V-T, CPE7-05, CPE7-05NC, CPE9-05, CPE9-05S, CPG7-05, CPG7-05NC, CPG9-05, CPG9-05S, EPC-350, GPC-350, ME9-10BM, ME9-10BMS, ME9-15BM, ME9-15BM316, ME9-15BMS, MG9-10, MG9-10BM, MG9-10BMS, MG9-10S, MG9-15, MG9-15BM, MG9-15BM316, MG9-15BMS, MG9-15S, MG9-20, MG9-20S, MPE9-10BM, MPE9-10BMS, MPE9-15BM, MPE9-15BMS, MPG9-10, MPG9-10BM, MPG9-10BMS, MPG9-10S, MPG9-15, MPG9-15BM, MPG9-15BMS, MPG9-15S...(Other models you can see in the webshop) |                 |                     |



2

|   |  |                 |                     |                     |
|---|--|-----------------|---------------------|---------------------|
| <b>GEV No.</b>  | 514161   | <b>Ref. No.</b> | 12009309<br>S102113 |                     |
| <b>description</b>  | shut-off valve connection 1/2" 1/2" straight total length 28mm mounting pos. left angled shaft intake ø M5x0.8mm rosette thread G2 27x19G shaft 7x7  |                 |                     |                     |
| <b>For models:</b>  | ME9-10BM, ME9-10BMS, ME9-15BM, ME9-15BM316, ME9-15BMS, MG9-10, MG9-10BM, MG9-10BMS, MG9-10S, MG9-15, MG9-15BM, MG9-15BM316, MG9-15BMS, MG9-15S, MG9-20, MG9-20S, MPE9-10BM, MPE9-10BMS, MPE9-15BM, MPE9-15BMS, MPG9-10, MPG9-10BM, MPG9-10BMS, MPG9-10S, MPG9-15, MPG9-15BM, MPG9-15BMS, MPG9-15S, MPG9-20, MPG9-20S, SBE9-10, SBE9-10I, SBE9-10IM, SBE9-10IMS, SBE9-10IS, SBE9-10M, SBE9-10MS, SBE9-10S, SBE9-15IM, SBE9-15IMS, SBG9-10, SBG9-10I, SBG9-10IM, SBG9-10IMS, SBG9-10IS, SBG9-10M, SBG9-10MS, SBG9-10S, SBG9-15IM, SBG9-15IMS |                 |                     |                     |
| <b>spare parts for</b>  | 514161   |                 |                     |                     |
|  | <b>GEV No.</b>   | 514085          | <b>Ref. No.</b>     | 12009132<br>S012102 |
|   | rosette connection 26x19G chrome-plated total lengthmm mounting pos.   |                 |                     |                     |
|  | <b>GEV No.</b>   | 514086          | <b>Ref. No.</b>     | —                   |
|   | hexagonal nut connection 26x19G brass total lengthmm mounting pos. H 6mm WS 34 Qty 1 pcs   |                 |                     |                     |
|  | <b>GEV No.</b>   | 540414          | <b>Ref. No.</b>     | —                   |
|   | star handle connection hot total lengthmm mounting pos. shaft diameter 7x7mm ø 55mm 35 built-in depth 22mm   |                 |                     |                     |
|  | <b>GEV No.</b>   | 540415          | <b>Ref. No.</b>     | 12009120<br>S102109 |
|   | star handle connection cold total lengthmm mounting pos. shaft diameter 7x7mm ø 55mm 35 built-in depth 22mm  |                 |                     |                     |

**spare parts for** 514000

|   |   |        |                 |                     |
|---|---|--------|-----------------|---------------------|
|    | <b>GEV No.</b>  | 514085 | <b>Ref. No.</b> | 12009132<br>S012102 |
|   | rosette connection 26x19G chrome-plated total lengthmm mounting pos.  |        |                 |                     |
|   | <b>GEV No.</b>  | 514086 | <b>Ref. No.</b> | —                   |
|   | hexagonal nut connection 26x19G brass total lengthmm mounting pos. H 6mm WS 34 Qty 1 pcs                    |        |                 |                     |
|  | <b>GEV No.</b>  | 540414 | <b>Ref. No.</b> | —                   |
|   | star handle connection hot total lengthmm mounting pos. shaft diameter 7x7mm ø 55mm 35 built-in depth 22mm  |        |                 |                     |
|  | <b>GEV No.</b>  | 540415 | <b>Ref. No.</b> | 12009120<br>S102109 |
|   | star handle connection cold total lengthmm mounting pos. shaft diameter 7x7mm ø 55mm 35 built-in depth 22mm |        |                 |                     |



1

|                    |   |                 |                     |
|--------------------|---|-----------------|---------------------|
| <b>GEV No.</b>     | 540415  | <b>Ref. No.</b> | 12009120<br>S102109 |
| <b>description</b> | star handle connection cold total lengthmm mounting pos. shaft diameter 7x7mm ø 55mm 35 built-in depth 22mm   |                 |                     |
| <b>For models:</b> | BME9-05, BME9-05AD, BME9-05PLUS, BME9-05V-T, BME9-10, BME9-10AD, BME9-10PLUS, BME9-10V-T, BMG9-05, BMG9-05V-T, BMG9-10, BMG9-10V-T, CPE7-05, CPE7-05NC, CPE9-05, CPE9-05S, CPG7-05, CPG7-05NC, CPG9-05, CPG9-05S, EPC-350, GPC-350, ME9-10BM, ME9-10BMS, ME9-15BM, ME9-15BM316, ME9-15BMS, MG9-10, MG9-10BM, MG9-10BMS, MG9-10S, MG9-15, MG9-15BM, MG9-15BM316, MG9-15BMS, MG9-15S, MG9-20, MG9-20S, MPE9-10BM, MPE9-10BMS, MPE9-15BM, MPE9-15BMS, MPG9-10, MPG9-10BM, MPG9-10BMS, MPG9-10S, MPG9-15, MPG9-15BM, MPG9-15BMS, MPG9-15S...(Other models you can see in the webshop) |                 |                     |

Зип-Общепит  
inlet taps

vsezip.ru

77(812)987-08-81



1

|                    |   |                 |                     |
|--------------------|---|-----------------|---------------------|
| <b>GEV No.</b>     | 514085  | <b>Ref. No.</b> | 12009132<br>S012102 |
| <b>description</b> | rosette connection 26x19G chrome-plated total lengthmm mounting pos.  |                 |                     |
| <b>For models:</b> | BME9-05, BME9-05AD, BME9-05PLUS, BME9-05V-T, BME9-10, BME9-10AD, BME9-10PLUS, BME9-10V-T, BMG9-05, BMG9-05V-T, BMG9-10, BMG9-10V-T, CPE7-05, CPE7-05NC, CPE9-05, CPE9-05S, CPG7-05, CPG7-05NC, CPG9-05, CPG9-05S, EPC-350, GPC-350, ME9-10BM, ME9-10BMS, ME9-15BM, ME9-15BM316, ME9-15BMS, MG9-10, MG9-10BM, MG9-10BMS, MG9-10S, MG9-15, MG9-15BM, MG9-15BM316, MG9-15BMS, MG9-15S, MG9-20, MG9-20S, MPE9-10BM, MPE9-10BMS, MPE9-15BM, MPE9-15BMS, MPG9-10, MPG9-10BM, MPG9-10BMS, MPG9-10S, MPG9-15, MPG9-15BM, MPG9-15BMS, MPG9-15S...(Other models you can see in the webshop) |                 |                     |







1

|                    |  |                 |                     |
|--------------------|--|-----------------|---------------------|
| <b>GEV No.</b>     | 691015   | <b>Ref. No.</b> | 12009374<br>S052100 |
| <b>description</b> | inlet spout connection 1/2" ET   |                 |                     |
| <b>For models:</b> | CPE7-05, CPE7-05NC, CPG7-05, CPG7-05NC, EPC-350, GPC-350, ME7-10BM, ME9-10BM, ME9-10BMS, ME9-10PLUS-BM, ME9-10PLUS-BMS, ME9-15BM, ME9-15BM316, ME9-15BM-AD, ME9-15BMS, ME9-15PLUS-BM, ME9-15PLUS-BMS, MG7-10, MG7-10BM, MG9-10, MG9-10AD, MG9-10BM, MG9-10BMAD, MG9-10BMS, MG9-10BMSAD, MG9-10PLUS, MG9-10PLUS-BM, MG9-10PLUS-BMS, MG9-10PLUS-S, MG9-10S, MG9-10S-AD, MG9-15, MG9-15AD, MG9-15BM, MG9-15BM316, MG9-15BMAD, MG9-15BMS, MG9-15BMSAD, MG9-15PLUS, MG9-15PLUS-BM, MG9-15PLUS-BMS, MG9-15PLUS-S, MG9-15S, MG9-15S-AD, MG9-20, MG9-20AD, MG9-20PLUS, MG9-20PLUS-S, MG9-20S, MG9-20S-AD...(Other models you can see in the webshop) |                 |                     |



1

|   |   |                 |                     |                     |
|---|---|-----------------|---------------------|---------------------|
| <b>GEV No.</b>  | 514160  | <b>Ref. No.</b> | 12019085<br>S012101 |                     |
| <b>description</b>  | shut-off valve connection 1/2" 1/2" straight total length 54mm mounting pos. star-shaped mounting thread 26x19G |                 |                     |                     |
| <b>accessories for</b>  | 514160  |                 |                     |                     |
|  | <b>GEV No.</b>  | 514085          | <b>Ref. No.</b>     | 12009132<br>S012102 |
|  | <b>GEV No.</b>  | 514086          | <b>Ref. No.</b>     | —                   |
|  | <b>GEV No.</b>  | 548168          | <b>Ref. No.</b>     | —                   |
|  | <b>GEV No.</b>  | 548169          | <b>Ref. No.</b>     | 12019545<br>S012104 |



1

|                    |  |                 |  |
|--------------------|--|-----------------|--|
| <b>GEV No.</b>     | 691019   | <b>Ref. No.</b> | 12014163<br>12040128<br>X156104<br>X156140 |
| <b>description</b> | inlet spout connection 1/2" ET tube ø 14mm projection 110mm overall height 80mm spout height 60mm rotation°  |                 |  |
| <b>For models:</b> | SBE7-10, SBE9-10, SBE9-10I, SBE9-10IM, SBE9-10IMS, SBE9-10IS, SBE9-10M, SBE9-10MS, SBE9-10S, SBE9-15IM, SBE9-15IMS, SBG7-10, SBG9-10, SBG9-10I, SBG9-10IM, SBG9-10IMS, SBG9-10IS, SBG9-10M, SBG9-10MS, SBG9-10S, SBG9-15IM, SBG9-15IMS |                 |  |

## accessories

## diaphragms



1

|                    |  |                 |         |
|--------------------|--|-----------------|---------|
| <b>GEV No.</b>     | 542000   | <b>Ref. No.</b> | S206121 |
| <b>description</b> | plain washer ID ø 22mm ED ø 50mm thickness 8mm |                 |         |



1

|                    |   |                 |                     |
|--------------------|---|-----------------|---------------------|
| <b>GEV No.</b>     | 548169  | <b>Ref. No.</b> | 12019545<br>S012104 |
| <b>description</b> | star handle connection cold total lengthmm mounting pos. chrome-plated ø 57mm |                 |                     |



drain systems and wash basins **Зип Общепит**

drain fittings

universal



|                        |   |                 |                     |
|------------------------|---|-----------------|---------------------|
| <b>GEV No.</b>         | 515041  | <b>Ref. No.</b> | 12000168<br>R205019 |
| <b>description</b>     | drain fitting size 3/4" usable heightmm overall height 30mm ED ø 38mm chrome-plated brass             |                 |                     |
| <b>For models:</b>     | BME7-05, BME7-10, BME9-05, BME9-10, BMG7-10, BMG9-05, BMG9-10   |                 |                     |
| <b>accessories for</b> | 515041  |                 |                     |
|                        | <b>GEV No.</b>  | 515047          | <b>Ref. No.</b> —   |
|                        | standpipe size 3/4" usable height 28mm overall height 54mm ED ø 20mm chrome-plated brass with O-ring  |                 |                     |
|                        | <b>GEV No.</b>  | 515048          | <b>Ref. No.</b> —   |
|                        | standpipe size 3/4" usable height 48mm overall height 74mm ED ø 20mm chrome-plated brass with O-ring  |                 |                     |
|                        | <b>GEV No.</b>  | 515049          | <b>Ref. No.</b> —   |
|                        | standpipe size 3/4" usable height 68mm overall height 94mm ED ø 20mm chrome-plated brass with O-ring  |                 |                     |
|                        | <b>GEV No.</b>  | 515050          | <b>Ref. No.</b> —   |
|                        | standpipe size 3/4" usable height 98mm overall height 124mm ED ø 20mm chrome-plated brass with O-ring |                 |                     |

standpipes

3/4"



|                        |   |                 |                     |
|------------------------|---|-----------------|---------------------|
| <b>GEV No.</b>         | 515041  | <b>Ref. No.</b> | 12000168<br>R205019 |
| <b>description</b>     | drain fitting size 3/4" usable heightmm overall height 30mm ED ø 38mm chrome-plated brass             |                 |                     |
| <b>For models:</b>     | BME7-05, BME7-10, BME9-05, BME9-10, BMG7-10, BMG9-05, BMG9-10   |                 |                     |
| <b>accessories for</b> | 515041  |                 |                     |
|                        | <b>GEV No.</b>  | 515047          | <b>Ref. No.</b> —   |
|                        | standpipe size 3/4" usable height 28mm overall height 54mm ED ø 20mm chrome-plated brass with O-ring  |                 |                     |
|                        | <b>GEV No.</b>  | 515048          | <b>Ref. No.</b> —   |
|                        | standpipe size 3/4" usable height 48mm overall height 74mm ED ø 20mm chrome-plated brass with O-ring  |                 |                     |
|                        | <b>GEV No.</b>  | 515049          | <b>Ref. No.</b> —   |
|                        | standpipe size 3/4" usable height 68mm overall height 94mm ED ø 20mm chrome-plated brass with O-ring  |                 |                     |
|                        | <b>GEV No.</b>  | 515050          | <b>Ref. No.</b> —   |
|                        | standpipe size 3/4" usable height 98mm overall height 124mm ED ø 20mm chrome-plated brass with O-ring |                 |                     |

FAGOR

|                        |   |                 |                     |
|------------------------|---|-----------------|---------------------|
| <b>GEV No.</b>         | 515041  | <b>Ref. No.</b> | 12000168<br>R205019 |
| <b>description</b>     | drain fitting size 3/4" usable heightmm overall height 30mm ED ø 38mm chrome-plated brass             |                 |                     |
| <b>For models:</b>     | BME7-05, BME7-10, BME9-05, BME9-10, BMG7-10, BMG9-05, BMG9-10   |                 |                     |
| <b>accessories for</b> | 515041  |                 |                     |
|                        | <b>GEV No.</b>  | 515047          | <b>Ref. No.</b> —   |
|                        | standpipe size 3/4" usable height 28mm overall height 54mm ED ø 20mm chrome-plated brass with O-ring  |                 |                     |
|                        | <b>GEV No.</b>  | 515048          | <b>Ref. No.</b> —   |
|                        | standpipe size 3/4" usable height 48mm overall height 74mm ED ø 20mm chrome-plated brass with O-ring  |                 |                     |
|                        | <b>GEV No.</b>  | 515049          | <b>Ref. No.</b> —   |
|                        | standpipe size 3/4" usable height 68mm overall height 94mm ED ø 20mm chrome-plated brass with O-ring  |                 |                     |
|                        | <b>GEV No.</b>  | 515050          | <b>Ref. No.</b> —   |
|                        | standpipe size 3/4" usable height 98mm overall height 124mm ED ø 20mm chrome-plated brass with O-ring |                 |                     |



|                    |   |                 |                     |
|--------------------|---|-----------------|---------------------|
| <b>GEV No.</b>     | 691024  | <b>Ref. No.</b> | 12019791<br>R205018 |
| <b>description</b> | overflow pipe L 165mm ø 20mm                                  |                 |                     |
| <b>For models:</b> | BME7-05, BME7-10, BME9-05, BME9-10, BMG7-10, BMG9-05, BMG9-10 |                 |                     |

accessories

|  |                    |                            |                 |                     |
|--|--------------------|----------------------------|-----------------|---------------------|
|  | <b>GEV No.</b>     | 691004                     | <b>Ref. No.</b> | 12000169<br>R202617 |
|  | <b>description</b> | protective plate for drain |                 |                     |
|  | <b>For models:</b> | BMG9-05, BMG9-10           |                 |                     |

water and beverage technology

water cycle components

pressure reduction valves

pressure reduction valves

producer-specific



|                    |  |                 |                     |
|--------------------|--|-----------------|---------------------|
| 1                  |  |                 |                     |
| <b>GEV No.</b>     | 520558   | <b>Ref. No.</b> | 12024846<br>Z102307 |
| <b>description</b> | pressure reduction valve RBM series RINOXDUE connection 3/4" default setting 3bar setting range 0.5-4bar p max 25bar t.max. 80°C nickel-plated brass ACS   |                 |                     |
| <b>For models:</b> | AD-120CW, CO-142W, CO-142WDD, ECO-160, ECO-1600, ECO-200, ECO-200H, ECO-2300, ECO-3000, FI-120W, FI-160, FI-1600, FI-160AR, FI-160D, FI-160I, FI-200, FI-200AR, FI-200D, FI-200H, FI-200HD, FI-200HI, FI-200I, FI-200W, FI-200WL, FI-200WR, FI-2300, FI-2700D, FI-2700I, FI-280D, FI-280I, FI-3000, FI-370D, FI-370I, FI-4000D, FI-4000I, FI-460D, FI-460I, FI-550D, FI-550I, FI-6000D, FI-6000I, FI-80W |                 |                     |

ancillary products

silicone

food-grade silicones



|                    |   |                 |                        |
|--------------------|---|-----------------|------------------------|
| 1                  |   |                 |                        |
| <b>GEV No.</b>     | 890106  | <b>Ref. No.</b> | 12032727<br>RT50060200 |
| <b>description</b> | silicone TB40 transparent tube 90g -40 up to +160°C   |                 |                        |
| <b>description</b> | <p>Tomabond - TB40 - tube 90g - transparent</p> <p>For flexible sealing in drinking water, food, water and industrial kitchen areas. Securely joins glass, metal, wood-based materials, ceramic and plastics with high adhesion (1.1 N/mm<sup>2</sup>).</p> <p>Fungicide-, algicide- and solvent-free, ageing-resistant.</p> <p>Temperature-resistant from -40 °C to +160 °C</p> <p>Tested and approved by KTW / KSW.</p> |                 |                        |

Зип-Общепит

clamps

hose clamps

DIN 3017



|                    |  |                 |                        |
|--------------------|--|-----------------|------------------------|
| 1                  |  |                 |                        |
| <b>GEV No.</b>     | 520111   | <b>Ref. No.</b> | 12035874<br>RT20660205 |
| <b>description</b> | hose clamp ø 10-16mm width 9mm Qty 10 pcs DIN 3017 |                 |                        |



|                    |   |                 |   |
|--------------------|---|-----------------|---|
| 1                  |   |                 |   |
| <b>GEV No.</b>     | 520114  | <b>Ref. No.</b> | 12010023<br>12035505<br>Q881304<br>RT20660506 |
| <b>description</b> | hose clamp ø 20-32mm width 9mm Qty 10 pcs DIN 3017  |                 |   |
| <b>For models:</b> | AD-120B, AD-120BBTDD-UK, AD-120C, AD-120HY, AD-125, AD-125HRS, AD-125-SOFT, AD-505, AD-505-SOFT, AD-90BA, AD-90BBT, AD-90BDD, ADE-120B, APE-061, APE-061W, APE-101, APE-101W, APE-102, APE-102W, APE-201, APE-202, APG-061, APG-061W, APG-101, APG-101W, APG-102, APG-102W, APG-201, APG-202, BME9-05, BME9-10, BMG9-10, CO-110B, CO-110BDD, CO-112B, CO-112BDD, CO-170B, CO-170BDD, CO-172B, CO-172BDD, CO-500B, CO-500BDD, CO-501B, CO-501BDD, CO-502B, CO-502BDD, CO-502W, COP-173, COP-173B, COP-173BDD...(Other models you can see in the webshop) |                 |   |



|                    |  |                 |                     |
|--------------------|--|-----------------|---------------------|
| 1                  |  |                 |                     |
| <b>GEV No.</b>     | 520115   | <b>Ref. No.</b> | 12009997<br>Q881305 |
| <b>description</b> | hose clamp ø 25-40mm width 9mm Qty 10 pcs DIN 3017   |                 |                     |
| <b>For models:</b> | AD-45BBT, AD-48, AD-48B, AD-48BDD, AD-48C, AD-48D, AD-48DD, AD-48HY, AD-48W, AD-505, AD-64, AD-64B, AD-64BBT, AD-64BDD, AD-64BTDD, AD-64C, AD-64CW, AD-64D, AD-64DD, AD-64HY, AD-72, AD-72W, AE-201, AE-202, AG-061, AG-061W, AG-101, AG-101W, AG-102, AG-102W, AG-201, AG-202, APE-061, APE-061W, APE-101, APE-101W, APE-102, APE-102W, APE-201, APE-202, APG-061, APG-061W, APG-101, APG-101W, APG-102, APG-102W, APG-201, APG-202, BME7-05, BME7-10...(Other models you can see in the webshop) |                 |                     |





Зип Общепит  
vsezip.ru

|   |  |                 |   |
|---|--|-----------------|---|
|  |  |                 |   |
| 1   |  |                 |   |
| <b>GEV No.</b>  | 520118   | <b>Ref. No.</b> | 12009933<br>12036496<br>Q881324<br>RT20660300 |
| <b>description</b>  | hose clamp ø 50-70mm width 9mm Qty 5 pcs DIN 3017  |                 |   |
| <b>For models:</b>  | AD-45BBT, AD-48, AD-48B, AD-48BDD, AD-48C, AD-48D, AD-48DD, AD-48HY, AD-48W, AD-505, AD-505-SOFT, AD-64, AD-64B, AD-64BBT, AD-64BDD, AD-64BTDD, AD-64C, AD-64CW, AD-64D, AD-64DD, AD-64HY, AD-72, AD-72W, CO-500, CO-500B, CO-500BDD, CO-500DD, CO-501, CO-501B, CO-501BDD, CO-501DD, CO-501-SOFT, CO-502B, CO-502BDD, CO-502DD, CO-502W, COP-503, COP-503B, COP-503BDD, COP-503DD, COP-503-SOFT, COP-504, COP-504B, COP-504BDD, COP-504DD, COP-504W, EASY-500, EASY-500B, EASY-500DD, EASY-500HP... (Other models you can see in the webshop) |                 |   |

|  |  |                 |   |
|--|--|-----------------|---|
|  |  |                 |   |
| 1  |  |                 |   |
| <b>GEV No.</b>   | 520117   | <b>Ref. No.</b> | 12009962<br>12035446<br>Q881306000<br>Q881307<br>RT20660504 |
| <b>description</b>   | hose clamp stainless steel ø 40-60mm width 9mm Qty 5 pcs DIN 3017  |                 |   |
| <b>For models:</b>   | ACE-061, ACE-101, ACE-102, ACE-201, ACE-202, ACG-061, ACG-101, ACG-102, ACG-201, ACG-202, AD-120, AD-120B, AD-120BBTDD-UK, AD-120C, AD-120CW, AD-120HY, AD-125, AD-125HRS, AD-125-SOFT, AD-15, AD-15D, AD-20C-UK, AD-21, AD-21B, AD-21BDD, AD-21C, AD-21D, AD-21DD, AD-21W, AD-45BBT, AD-48, AD-48B, AD-48BDD, AD-48C, AD-48D, AD-48DD, AD-48HY, AD-48W, AD-505, AD-505-SOFT, AD-64, AD-64B, AD-64BBT, AD-64BDD, AD-64BTDD, AD-64C, AD-64CW, AD-64D, AD-64DD, AD-64HY... (Other models you can see in the webshop) |                 |   |

|   |   |                 |                        |
|---|---|-----------------|------------------------|
|  |   |                 |                        |
| 2   |   |                 |                        |
| <b>GEV No.</b>  | 520119  | <b>Ref. No.</b> | 12036081<br>RT20660516 |
| <b>description</b>  | hose clamp ø 60-80mm width 9mm Qty 5 pcs DIN 3017 |                 |                        |

|  |  |                 |                     |
|--|--|-----------------|---------------------|
| <b>DIN 3017 - W4</b>   |  |                 |                     |
|  |  |                 |                     |
| 1  |  |                 |                     |
| <b>GEV No.</b>   | 520120   | <b>Ref. No.</b> | 12010036<br>Q881302 |
| <b>description</b>   | hose clamp SS W4 ø 12-20mm width 9mm Qty 1 pcs DIN 3017  |                 |                     |
| <b>For models:</b>   | ACE-061, ACE-101, ACE-102, ACE-201, ACE-202, ACG-061, ACG-101, ACG-102, ACG-201, ACG-202, AD-120, AD-120B, AD-120BBTDD-UK, AD-120C, AD-120CW, AD-120HY, AD-125, AD-125HRS, AD-125-SOFT, AD-15, AD-15D, AD-20C-UK, AD-21, AD-21B, AD-21BDD, AD-21C, AD-21D, AD-21DD, AD-21W, AD-45BBT, AD-48, AD-48B, AD-48BDD, AD-48C, AD-48D, AD-48DD, AD-48HY, AD-48W, AD-505, AD-505-SOFT, AD-64, AD-64B, AD-64BBT, AD-64BDD, AD-64BTDD, AD-64C, AD-64CW, AD-64D, AD-64DD, AD-64HY... (Other models you can see in the webshop) |                 |                     |

|   |  |                 |   |
|---|--|-----------------|---|
|  |  |                 |   |
| 1   |  |                 |   |
| <b>GEV No.</b>  | 520454   | <b>Ref. No.</b> | 12009914<br>12036146<br>Q881326<br>RT20660505 |
| <b>description</b>  | hose clamp ø 70-90mm width 9mm Qty 5 pcs DIN 3017  |                 |   |
| <b>For models:</b>  | ACE-202, ACG-202, AE-202, AG-202, APE-202, APG-202, COE-202, ECO-2700D, ECO-2700I, ECO-280D, ECO-280I, ECO-370D, ECO-370I, ECO-4000D, ECO-4000I, ECO-460D, ECO-460I, ECO-550D, ECO-550I, ECO-6000D, ECO-6000I, FI-2700D, FI-2700I, FI-280D, FI-280I, FI-370D, FI-370I, FI-4000D, FI-4000I, FI-460D, FI-460I, FI-550D, FI-550I, FI-6000D, FI-6000I, HMG-10-21-STACKING, LA-13M, LA-18MP, LA-25M, LAC-25, LAC-25MP, LAC-25MPP, LAC-55, LAC-55MP, LAC-55MPP, LB-AC-10M, LB-E-10M, LB-V-10M, LC-10, LC-14... (Other models you can see in the webshop) |                 |   |

|  |  |                 |                        |
|--|--|-----------------|------------------------|
| <b>double wire clamps</b>  |  |                 |                        |
|  |  |                 |                        |
| 1  |  |                 |                        |
| <b>GEV No.</b>   | 511658   | <b>Ref. No.</b> | 12035823<br>RT20660533 |
| <b>description</b>   | hose clamp ø 10mm wire gauge ø 1.3mm steel Qty 5 pcs |                 |                        |

|   |   |                 |   |
|---|---|-----------------|---|
|  |   |                 |   |
| 1   |   |                 |   |
| <b>GEV No.</b>  | 520110  | <b>Ref. No.</b> | 12010047<br>12037543<br>GH51X003<br>Q881308 |
| <b>description</b>  | hose clamp ø 8-12mm width 9mm Qty 10 pcs DIN 3017   |                 |   |
| <b>For models:</b>  | AD-120, AD-120B, AD-120BBTDD-UK, AD-120C, AD-120CW, AD-120HY, AD-15, AD-15D, AD-20C-UK, AD-21, AD-21B, AD-21BDD, AD-21C, AD-21D, AD-21DD, AD-21W, AD-48, AD-48B, AD-48BDD, AD-48C, AD-48D, AD-48DD, AD-48W, AD-64, AD-64B, AD-64BDD, AD-64C, AD-64CW, AD-64D, AD-64DD, AD-72, AD-72W, AD-90, AD-90BA, AD-90BBT, AD-90BDD, AD-90DD, ADE-120, ADE-120B, CO-110, CO-110B, CO-110BDD, CO-110DD, CO-112, CO-112B, CO-112BDD, CO-112DD, CO-142W, CO-142WDD, CO-170... (Other models you can see in the webshop) |                 |   |

|  |  |                 |                        |
|--|--|-----------------|------------------------|
|  |  |                 |                        |
| 1  |  |                 |                        |
| <b>GEV No.</b>   | 520916   | <b>Ref. No.</b> | 12036614<br>RT20660518 |
| <b>description</b>   | hose clamp ø 30mm wire gauge ø 2.7mm chrome-plated steel Qty 1 pcs |                 |                        |

Зип-Общепит double wire clamps with screw

vsezip.ru

7(812)987-08-81

|   |  |                 |                        |
|---|--|-----------------|------------------------|
|  |  |                 |                        |
| 1   |  |                 |                        |
| <b>GEV No.</b>  | 560570   | <b>Ref. No.</b> | 12036450<br>RT20660519 |
| <b>description</b>  | hose clamp ø 35.6mm wire gauge ø 3mm Qty 1 pcs |                 |                        |

|   |   |                 |                     |
|---|---|-----------------|---------------------|
|  |   |                 |                     |
| 1   |   |                 |                     |
| <b>GEV No.</b>  | 505190  | <b>Ref. No.</b> | 12009972<br>Q901307 |
| <b>description</b>  | hose clamp ø 36-42mm wire gauge ø 3mm zinc-coated steel Qty 1 pcs   |                 |                     |
| <b>For models:</b>  | AD-15, AD-15D, AD-20C-UK, AD-21, AD-21B, AD-21BDD, AD-21C, AD-21D, AD-21DD, AD-21W, ECO-1200, FI-1200, FI-900, HEI-10-21, HEM-10-21, HGC-10-21, HGC-20-21, HGV-10-21, LVC-12, LVC-15, LVC-15D, LVC-21, LVC-21B, LVC-21C, LVC-21D, LVC-21W, LVR-10, LVR-14, LVR-14D, LVR-20, LVR-20B, LVR-20D, MF-21 |                 |                     |

|  |   |                 |                     |
|--|---|-----------------|---------------------|
|  |   |                 |                     |
| 1  |   |                 |                     |
| <b>GEV No.</b>   | 505191  | <b>Ref. No.</b> | 12007966<br>Q901308 |
| <b>description</b>   | hose clamp ø 52-59mm wire gauge ø 3.5mm Qty 1 pcs   |                 |                     |
| <b>For models:</b>   | AD-45BBT, AD-48, AD-48B, AD-48BDD, AD-48C, AD-48D, AD-48DD, AD-48HY, AD-48W, AD-64, AD-64B, AD-64BBT, AD-64BDD, AD-64BTDD, AD-64C, AD-64CW, AD-64D, AD-64DD, AD-64HY, AD-72, AD-72W, EASY-500, EASY-500B, EASY-500DD, EASY-500HP, FI-30, FI-30AR, FI-30AR+DD, FI-30B, FI-30B-BT-UK, FI-30-UK, FI-48, FI-48AR, FI-48B, FI-48B-BT-UK, FI-48C, FI-48D, FI-48HY-CLINIC, FI-48W, FI-50, FI-60DD, FI-64, FI-64AR, FI-64B, FI-64B-BT-UK, FI-64C, FI-64D, FI-64HY-CLINIC, FI-64W, FI-72...(Other models you can see in the webshop) |                 |                     |

|   |   |                 |                        |
|---|---|-----------------|------------------------|
|  |   |                 |                        |
| 1   |   |                 |                        |
| <b>GEV No.</b>  | 505351  | <b>Ref. No.</b> | 12036929<br>RT20660527 |
| <b>description</b>  | wire clamp ø 11.6-12.2mm wire gauge ø 1.5mm zinc-coated steel Qty 100 pcs |                 |                        |

|   |  |                 |                        |
|---|--|-----------------|------------------------|
|  |  |                 |                        |
| 1   |  |                 |                        |
| <b>GEV No.</b>  | 505358   | <b>Ref. No.</b> | 12036811<br>RT20660530 |
| <b>description</b>  | wire clamp ø 14.4-15.1mm wire gauge ø 1.8mm zinc-coated steel Qty 50 pcs |                 |                        |

|  |  |                 |                     |
|--|--|-----------------|---------------------|
|  |  |                 |                     |
| 1  |  |                 |                     |
| <b>GEV No.</b>   | 505079   | <b>Ref. No.</b> | 12025195<br>Z400903 |
| <b>description</b>   | hose clamp ø 186-172mm Qty 1 pcs   |                 |                     |
| <b>For models:</b>   | AD-15, AD-15D, AD-20C-UK, AD-21, AD-21B, AD-21BDD, AD-21C, AD-21D, AD-21DD, AD-21W, CO-350, CO-350-B, CO-350-B-DD, CO-350-COLD, CO-350-COLD-B, CO-350-COLD-B-DD, CO-350-COLD-DD, CO-350-DD, CO-352-COLD, CO-352-COLD-B, CO-352-COLD-B-DD, CO-352-COLD-DD, CO-400, CO-400-B, CO-400-B-DD, CO-400-COLD, CO-400-COLD-B, CO-400-COLD-B-DD, CO-400-COLD-DD, CO-400-DD, CO-400-SOFT, CO-402-COLD, CO-402-COLD-B, CO-402-COLD-B-DD, CO-402-COLD-DD, CO-402W, LVC-12, LVC-15, LVC-15D, LVC-21, LVC-21B, LVC-21C, LVC-21D, LVC-21W, LVR-10, LVR-14, LVR-14D, LVR-20, LVR-20B, LVR-20D...(Other models you can see in the webshop) |                 |                     |

|  |   |                 |                     |
|--|---|-----------------|---------------------|
|  |   |                 |                     |
| 1  |   |                 |                     |
| <b>GEV No.</b>   | 505080  | <b>Ref. No.</b> | 12023841<br>Z200908 |
| <b>description</b>   | hose clamp ø 235-215mm Qty 1 pcs  |                 |                     |
| <b>For models:</b>   | AD-45BBT, AD-48, AD-48B, AD-48BDD, AD-48C, AD-48D, AD-48DD, AD-48HY, AD-48W, AD-64, AD-64B, AD-64BBT, AD-64BDD, AD-64BTDD, AD-64C, AD-64CW, AD-64D, AD-64DD, AD-64HY, AD-72, AD-72W, EASY-500, EASY-500B, EASY-500DD, EASY-500HP, FI-30, FI-30AR, FI-30AR+DD, FI-30B, FI-30B-BT-UK, FI-30-UK, FI-48, FI-48AR, FI-48B, FI-48B-BT-UK, FI-48C, FI-48D, FI-48HY-CLINIC, FI-48W, FI-50, FI-60DD, FI-64, FI-64AR, FI-64B, FI-64B-BT-UK, FI-64C, FI-64D, FI-64HY-CLINIC, FI-64W, FI-72...(Other models you can see in the webshop) |                 |                     |

pipes

miscellaneous

|  |                              |                 |                     |
|--|------------------------------|-----------------|---------------------|
|  |                              |                 |                     |
| 1  |                              |                 |                     |
| <b>GEV No.</b>   | 691674                       | <b>Ref. No.</b> | 12018389<br>R725005 |
| <b>description</b>   | drain pipe ø 30mm L 440mm SS |                 |                     |



Зип Общепит  
vsezip.ru

+7(812)987-08-81

|   |   |                 |                     |
|---|---|-----------------|---------------------|
|  |   |                 |                     |
| 1   |   |                 |                     |
| <b>GEV No.</b>  | 691673  | <b>Ref. No.</b> | 12007494<br>R155010 |
| <b>description</b>  | drain pipe $\varnothing$ 38mm L 195mm   |                 |                     |
| <b>For models:</b>  | CG9-51L, CG9-51LC, CG9-51R, CG9-51RC, FTE9-05L, FTE9-05L-AD, FTE9-05PLUS-CL, FTE9-05PLUS-CR, FTE9-05PLUS-L, FTE9-05PLUS-R, FTE9-05R, FTE9-05R-AD, FTE9-10L, FTE9-10L+R, FTE9-10L+R-AD, FTE9-10L-AD, FTE9-10PLUS-CL, FTE9-10PLUS-CLR, FTE9-10PLUS-CR, FTE9-10PLUS-L, FTE9-10PLUS-LR, FTE9-10PLUS-R, FTE9-10R, FTE9-10R-AD, FTEC9-05L, FTEC9-05L-AD, FTEC9-05R, FTEC9-05R-AD, FTEC9-05USMC, FTEC9-10L, FTEC9-10L+R, FTEC9-10L+R-AD, FTEC9-10L-AD, FTEC9-10R, FTEC9-10R-AD, FTEC9-10USMC, FTG9-05L, FTG9-05L-AD, FTG9-05LV-AD, FTG9-05PLUS-CL, FTG9-05PLUS-CR, FTG9-05PLUS-L, FTG9-05PLUS-LV, FTG9-05PLUS-R, FTG9-05PLUS-RV, FTG9-05R, FTG9-05R-AD, FTG9-05RV-AD, FTG9-05VL, FTG9-05VR...(Other models you can see in the webshop) |                 |                     |

|  |   |                 |          |
|--|---|-----------------|----------|
|  |   |                 |          |
| <b>GEV No.</b>   | 539003  | <b>Ref. No.</b> | 12049669 |
| <b>description</b>   | thermometer mounting measurements 62x11mm 0 up to +120°C capillary pipe 1700mm probe $\varnothing$ 6mm probe L 25mm |                 |          |
| <b>For models:</b>   | COP-503, COP-503B, COP-503BDD, COP-503DD, COP-503-SOFT  |                 |          |

tools

cleaning tools

descaling pumps

descaling pumps

|  |  |                 |                        |
|--|--|-----------------|------------------------|
|  |  |                 |                        |
| 1  |  |                 |                        |
| <b>GEV No.</b>   | 890294   | <b>Ref. No.</b> | 12027850<br>RT60040203 |
| <b>description</b>   | descaling pump manual 12l/min connection stuff |                 |                        |

$\varnothing$ 52mm

|  |  |                 |          |
|--|--|-----------------|----------|
|  |  |                 |          |
| 1  |  |                 |          |
| <b>GEV No.</b>   | 542447   | <b>Ref. No.</b> | 12024717 |
| <b>description</b>   | thermometer mounting $\varnothing$ 52mm t.max. 105°C 20-105°C probe $\varnothing$ 8mm probe L 63mm capillary pipe 3400mm |                 |          |

measuring equipment

thermometers

built-in thermometers

|   |  |                 |                     |
|---|--|-----------------|---------------------|
|  |  |                 |                     |
| 1   |  |                 |                     |
| <b>GEV No.</b>  | 501492   | <b>Ref. No.</b> | 12023939<br>Z513023 |
| <b>description</b>  | thermometer mounting measurements 58x25.5mm +20 up to +120°C capillary pipe 3470mm probe $\varnothing$ 6mm probe L 35mm  |                 |                     |
| <b>For models:</b>  | ECO-160D, ECO-160I, ECO-200D, ECO-200HD, ECO-200HI, ECO-200I, ECO-2700D, ECO-2700I, ECO-280D, ECO-280I, ECO-370D, ECO-370I, ECO-4000D, ECO-4000I, ECO-460D, ECO-460I, ECO-550D, ECO-550I, ECO-6000D, ECO-6000I, FI-160AR, FI-160D, FI-160I, FI-200AR, FI-200D, FI-200HD, FI-200HI, FI-200I, FI-2700D, FI-2700I, FI-280D, FI-280I, FI-370D, FI-370I, FI-4000D, FI-4000I, FI-460D, FI-460I, FI-550D, FI-550I, FI-6000D, FI-6000I |                 |                     |

|   |  |                 |                        |
|---|--|-----------------|------------------------|
|  |  |                 |                        |
| 1   |  |                 |                        |
| <b>GEV No.</b>  | 541794   | <b>Ref. No.</b> | 12033869<br>6021350003 |
| <b>description</b>  | thermometer mounting $\varnothing$ 52mm t.max. 120°C 0 up to +120°C probe $\varnothing$ 6.5mm probe L 23mm capillary pipe 2000mm |                 |                        |
| <b>For models:</b>  | AC-120, AC-180   |                 |                        |

fastening material

rivets/rivet nuts

blind rivets DIN 7337 - aluminium

|  |  |                 |                     |
|--|--|-----------------|---------------------|
|  |  |                 |                     |
| 1  |  |                 |                     |
| <b>GEV No.</b>   | 560048   | <b>Ref. No.</b> | 12010266<br>Q419005 |
| <b>description</b>   | blind rivet aluminium $\varnothing$ 4mm L 8mm Qty 1 pcs  |                 |                     |
| <b>For models:</b>   | AD-120, AD-120B, AD-120BBTDD-UK, AD-120C, AD-120CW, AD-120HY, AD-15, AD-15D, AD-20C-UK, AD-21, AD-21B, AD-21BDD, AD-21C, AD-21D, AD-21DD, AD-21W, AD-64BTDD, AD-90, AD-90BA, AD-90BBT, AD-90BDD, AD-90DD, ADE-120, ADE-120B, BG6-05I, BG7-05, BG7-05I, BG7-10, BG7-10I, BG9-05, BG9-05AD, BG9-05I, BG9-05PF, BG9-05PI, BG9-05PLUS-I, BG9-10, BG9-10AD, BG9-10I, BG9-10PF, BG9-10PI, BG9-10PLUS-I, BME6-05, BME7-05, BME7-10, BME9-05, BME9-05AD, BME9-05PLUS, BME9-05V-T, BME9-10, BME9-10AD...(Other models you can see in the webshop) |                 |                     |

## Зип Общепит

## blind rivets DIN 7337 - stainless steel



1

|                    |  |                 |          |
|--------------------|--|-----------------|----------|
| <b>GEV No.</b>     | 560157   | <b>Ref. No.</b> | 12010065 |
| <b>description</b> | blind rivet SS $\phi$ 3.2mm L 6mm Qty 50 pcs DIN 1700  |                 |          |
| <b>For models:</b> | ACE-201, ACE-202, ACG-201, ACG-202, AE-201, AE-202, AG-201, AG-202, APE-201, APE-202, APG-201, APG-202, COE-202, COG-102, COG-202, EN9-05C, EN9-05C-AD, EN9-05PLUS-C, EN9-10C, EN9-10C-AD, EN9-10PLUS-C, HEI-20-21, HEM-20-21, HEP-10-21, HEP-20-21, HGC-20-21, HGP-10-21, HGP-20-21, HGV-20-21, VE-202, VG-102, VG-202, VPE-202, VPG-102, VPG-202 |                 |          |



1

|                    |   |                 |                     |
|--------------------|---|-----------------|---------------------|
| <b>GEV No.</b>     | 560049  | <b>Ref. No.</b> | 12010090<br>Q412002 |
| <b>description</b> | blind rivet SS $\phi$ 4mm L 7.5mm Qty 50 pcs  |                 |                     |
| <b>For models:</b> | ACE-061, ACE-101, ACE-102, ACE-201, ACE-202, ACG-061, ACG-101, ACG-102, ACG-201, ACG-202, AE-061, AE-061W, AE-101, AE-101W, AE-102, AE-102W, AE-201, AE-202, AG-061, AG-061W, AG-101, AG-101W, AG-102, AG-102W, AG-201, AG-202, APE-061, APE-061W, APE-101, APE-101W, APE-102, APE-102W, APE-201, APE-202, APG-061, APG-061W, APG-101, APG-101W, APG-102, APG-102W, APG-201, APG-202, BG6-05I, BG7-05, BG7-05I, BG7-10, BG7-10I, CE9-41, CGE9-41, COE-061...(Other models you can see in the webshop) |                 |                     |

## blind rivets DIN 7337 - zinc-coated steel



1

|                    |   |                 |                     |
|--------------------|---|-----------------|---------------------|
| <b>GEV No.</b>     | 560047  | <b>Ref. No.</b> | 12010117<br>Q411304 |
| <b>description</b> | blind rivet steel $\phi$ 4.8mm L 11.3mm Qty 1 pcs   |                 |                     |
| <b>For models:</b> | AD-120, AD-120B, AD-120BTTDD-UK, AD-120C, AD-120CW, AD-120HY, AD-48BDD, AD-48C, AD-48DD, AD-48W, AD-64BDD, AD-64C, AD-64CW, AD-64DD, AD-72, AD-72W, AD-90, AD-90BA, AD-90BBT, AD-90BDD, AD-90DD, ADE-120, ADE-120B, BG9-05, BG9-10, BME7-05, BME7-10, BME9-05, BME9-05AD, BME9-05PLUS, BME9-05V-T, BME9-10, BME9-10AD, BME9-10PLUS, BME9-10V-T, BMG7-10, BMG9-05, BMG9-05V-T, BMG9-10, BMG9-10V-T, CE6-41, CE7-41, CE7-41Q, CE9-41, CE9-41AD, CE9-41PLUS, CG-1002, CG-1502, CG-2002, CG-2002P...(Other models you can see in the webshop) |                 |                     |

## sealed blind rivets



1

|                    |   |                 |                        |
|--------------------|---|-----------------|------------------------|
| <b>GEV No.</b>     | 560180  | <b>Ref. No.</b> | 12037604<br>RT16030165 |
| <b>description</b> | sealed blank rivets SS $\phi$ 3.2mm L 10mm Qty 50 pcs |                 |                        |

## blind rivets hexagonal



1

|                    |  |                 |                     |
|--------------------|--|-----------------|---------------------|
| <b>GEV No.</b>     | 550777   | <b>Ref. No.</b> | 12010024<br>Q221345 |
| <b>description</b> | rivet nut thread M10 DN 13mm L 22mm Qty 1 pcs  |                 |                     |
| <b>For models:</b> | BG6-05I, BG7-05, BG7-05I, BG7-10, BG7-10I, BG9-05, BG9-05AD, BG9-05I, BG9-05PF, BG9-05PI, BG9-05PLUS-I, BG9-10, BG9-10AD, BG9-10I, BG9-10PF, BG9-10PI, BG9-10PLUS-I, BME7-05, BME7-10, BME9-05, BME9-05AD, BME9-05PLUS, BME9-05V-T, BME9-10, BME9-10AD, BME9-10PLUS, BME9-10V-T, BMG7-10, BMG9-05, BMG9-05V-T, BMG9-10, BMG9-10V-T, CE7-20, CE7-20Q, CE7-40, CE7-40Q, CE9-20, CE9-20AD, CE9-20PLUS, CE9-40, CE9-40AD, CE9-40PLUS, CG-2005, CG-210, CG-210G, CG-3005, CG-310, CG-310G, CG7-10, CG7-20...(Other models you can see in the webshop) |                 |                     |



1

|                    |  |                 |                     |
|--------------------|--|-----------------|---------------------|
| <b>GEV No.</b>     | 696427   | <b>Ref. No.</b> | 12009970<br>Q222011 |
| <b>description</b> | rivet nut thread M5 DN 4mm L 12mm SS Qty 1 pcs $\phi$ 7mm WS 6   |                 |                     |
| <b>For models:</b> | ACE-061, ACE-101, ACE-102, ACE-201, ACE-202, ACG-061, ACG-101, ACG-102, ACG-201, ACG-202, AD-45BBT, AD-48HY, AD-64BBT, AD-64BTDD, AD-64HY, AE-061, AE-061W, AE-101, AE-101W, AE-102, AE-102W, AE-201, AE-202, AG-061, AG-061W, AG-101, AG-101W, AG-102, AG-102W, AG-201, AG-202, APE-061, APE-061W, APE-101, APE-101W, APE-102, APE-102W, APE-201, APE-202, APG-061, APG-061W, APG-101, APG-101W, APG-102, APG-102W, APG-201, APG-202, CE9-40, CE9-41, CG-2000...(Other models you can see in the webshop) |                 |                     |



1

|                    |  |                 |                     |
|--------------------|--|-----------------|---------------------|
| <b>GEV No.</b>     | 551034   | <b>Ref. No.</b> | 12010163<br>Q221342 |
| <b>description</b> | rivet nut thread M5 DN 7mm L 12mm Qty 10 pcs   |                 |                     |
| <b>For models:</b> | ACE-061, ACE-101, ACE-102, ACE-201, ACE-202, ACG-061, ACG-101, ACG-102, ACG-201, ACG-202, AD-120, AD-120B, AD-120BTTDD-UK, AD-120C, AD-120CW, AD-120HY, AD-45BBT, AD-48HY, AD-64, AD-64B, AD-64BBT, AD-64BTDD, AD-64C, AD-64D, AD-64DD, AD-64HY, AD-72, AD-90, AD-90BA, AD-90BBT, AD-90BDD, AD-90DD, ADE-120, ADE-120B, AE-061, AE-061W, AE-101, AE-101W, AE-102, AE-102W, AE-201, AE-202, AG-061, AG-061W, AG-101, AG-101W, AG-102, AG-102W, AG-201, AG-202...(Other models you can see in the webshop) |                 |                     |



Зип Общепит

COUNTERSUNK SCREWS

vsezip.ru

+7(812)987-08-81

|   |  |                 |                     |
|---|--|-----------------|---------------------|
|  |  |                 |                     |
| 1   |  |                 |                     |
| <b>GEV No.</b>  | 550776   | <b>Ref. No.</b> | 12010126<br>Q221343 |
| <b>description</b>  | rivet nut thread M6 DN 10mm L 15mm SS Qty 1 pcs  |                 |                     |
| <b>For models:</b>  | ACE-061, ACE-101, ACE-102, ACE-201, ACE-202, ACG-061, ACG-101, ACG-102, ACG-201, ACG-202, ADE-120, ADE-120B, AE-061, AE-061W, AE-101, AE-101W, AE-102, AE-102W, AE-201, AE-202, AG-061, AG-061W, AG-101, AG-101W, AG-102, AG-102W, AG-201, AG-202, APE-061, APE-061W, APE-101, APE-101W, APE-102, APE-102W, APE-201, APE-202, APG-061, APG-061W, APG-101, APG-101W, APG-102, APG-102W, APG-201, APG-202, BG6-05I, BG7-05, BG7-05I, BG7-10, BG7-10I, BG9-05...(Other models you can see in the webshop) |                 |                     |

|   |  |                 |          |
|---|--|-----------------|----------|
|  |  |                 |          |
| 1   |  |                 |          |
| <b>GEV No.</b>  | 560041   | <b>Ref. No.</b> | 12010199 |
| <b>description</b>  | countersunk screw thread M5 L 16mm WS 3 SS DIN 7991/ISO 10642 Qty 20 pcs intake hexagonal  |                 |          |
| <b>For models:</b>  | ACE-061, ACE-101, ACE-102, ACG-061, ACG-101, ACG-102, AE-061, AE-061W, AE-101, AE-101W, AE-102, AE-102W, AG-061, AG-061W, AG-101, AG-101W, AG-102, AG-102W, APE-061, APE-061W, APE-101, APE-101W, APE-102, APE-102W, APG-061, APG-061W, APG-101, APG-101W, APG-102, APG-102W |                 |          |

SCREWS

sheet metal screws

|   |   |                 |                     |
|---|---|-----------------|---------------------|
|  |   |                 |                     |
| 1   |   |                 |                     |
| <b>GEV No.</b>  | 560098  | <b>Ref. No.</b> | 12010290<br>Q082032 |
| <b>description</b>  | sheet metal screws ø 3.5mm L 9.5mm SS Qty 20 pcs DIN 7981/ISO 7049 head ø 6.9mm oval head   |                 |                     |
| <b>For models:</b>  | AD-120, AD-120B, AD-120BBTDD-UK, AD-120C, AD-120CW, AD-120HY, AD-15, AD-15D, AD-20C-UK, AD-21, AD-21B, AD-21BDD, AD-21C, AD-21D, AD-21DD, AD-21W, AD-45BBT, AD-48, AD-48B, AD-48BDD, AD-48C, AD-48D, AD-48DD, AD-48HY, AD-48W, AD-64, AD-64B, AD-64BBT, AD-64BDD, AD-64BTDD, AD-64C, AD-64CW, AD-64D, AD-64DD, AD-64HY, AD-72, AD-72W, AD-90, AD-90BA, AD-90BBT, AD-90BDD, AD-90DD, ADE-120, ADE-120B, EASY-500, EASY-500B, EASY-500DD, EASY-500HP, EASY-500HPWBDD, ECO-120...(Other models you can see in the webshop) |                 |                     |

|   |   |                 |                                 |
|---|---|-----------------|---------------------------------|
|  |   |                 |                                 |
| 1   |   |                 |                                 |
| <b>GEV No.</b>  | 560076  | <b>Ref. No.</b> | 12009852<br>12010293<br>Q152024 |
| <b>description</b>  | countersunk screw thread M4 L 10mm SS DIN 963/ISO 2009 Qty 20 pcs intake slotted head ø 7.5mm   |                 |                                 |
| <b>For models:</b>  | AD-120, AD-120B, AD-120BBTDD-UK, AD-120C, AD-120CW, AD-120HY, AD-15, AD-15D, AD-20C-UK, AD-21, AD-21B, AD-21BDD, AD-21C, AD-21D, AD-21DD, AD-21W, AD-45BBT, AD-48, AD-48B, AD-48BDD, AD-48C, AD-48D, AD-48DD, AD-48HY, AD-48W, AD-64, AD-64B, AD-64BBT, AD-64BDD, AD-64BTDD, AD-64C, AD-64CW, AD-64D, AD-64DD, AD-64HY, AD-72, AD-72W, AD-90, AD-90BA, AD-90BBT, AD-90BDD, AD-90DD, ADE-120, ADE-120B, CGP9-11, EASY-500, EASY-500B, EASY-500DD, EASY-500HP, EASY-500HPWBDD...(Other models you can see in the webshop) |                 |                                 |

|   |   |                 |                     |
|---|---|-----------------|---------------------|
|  |   |                 |                     |
| 1   |   |                 |                     |
| <b>GEV No.</b>  | 560108  | <b>Ref. No.</b> | 12010257<br>Q082005 |
| <b>description</b>  | sheet metal screws ø 4.2mm L 13mm SS Qty 20 pcs DIN 7981/ISO 7049 head ø 8.2mm oval head  |                 |                     |
| <b>For models:</b>  | CPG9-05AD, CPG9-05AD-S, CPG9-05PLUS, CPG9-05PLUS-S, CV9-20AD, CV9-20PLUS, CV9-40AD, CV9-40PLUS, ECO-160D, ECO-160I, ECO-200D, ECO-200HD, ECO-200HI, ECO-200I, ECO-280D, ECO-280I, ECO-370D, ECO-370I, ECO-460D, ECO-460I, ECO-550D, ECO-550I, FG7-05-1C, FG7-05-2C, FG7-10-2C, FG7-104C, FG7-10-4C, FG9-05-1C, FG9-05-2C, FG9-05AD, FG9-05PLUS, FG9-05PLUS-S, FG9-05S-1C, FG9-05S-2C, FG9-05S-AD, FG9-10-2C, FG9-10-4C, FG9-10AD, FG9-10PLUS, FGCL9-05-1C, FGCL9-05-2C, FGCL9-05S-1C, FGCL9-05S-2C, FI-160AR, FI-160D, FI-160I, FI-200AR, FI-200D, FI-200HD, FI-200HI...(Other models you can see in the webshop) |                 |                     |

|   |  |                 |                     |
|---|--|-----------------|---------------------|
|  |  |                 |                     |
| 1   |  |                 |                     |
| <b>GEV No.</b>  | 560211   | <b>Ref. No.</b> | 12010262<br>Q042022 |
| <b>description</b>  | countersunk screw thread M4 L 14mm SS DIN 963/ISO 2009 Qty 20 pcs intake slotted head ø 7.5mm  |                 |                     |
| <b>For models:</b>  | ACE-061, ACE-101, ACE-102, ACE-201, ACE-202, ACG-061, ACG-101, ACG-102, ACG-201, ACG-202, AD-120, AD-120B, AD-120BBTDD-UK, AD-120C, AD-120CW, AD-120HY, AD-15, AD-15D, AD-20C-UK, AD-21, AD-21B, AD-21BDD, AD-21C, AD-21D, AD-21DD, AD-21W, AD-45BBT, AD-48, AD-48B, AD-48BDD, AD-48C, AD-48D, AD-48DD, AD-48HY, AD-64, AD-64B, AD-64BDD, AD-64BTDD, AD-64C, AD-64D, AD-64DD, AD-64HY, AD-72, AD-90, AD-90BA, AD-90BBT, AD-90BDD, AD-90DD, ADE-120, ADE-120B...(Other models you can see in the webshop) |                 |                     |

|   |  |                 |                     |
|---|--|-----------------|---------------------|
|  |  |                 |                     |
| 1   |  |                 |                     |
| <b>GEV No.</b>  | 560263   | <b>Ref. No.</b> | 12010287<br>Q041324 |
| <b>description</b>  | countersunk screw thread M4 L 25mm SS DIN 963/ISO 2009 Qty 20 pcs intake slotted head ø 7.5mm  |                 |                     |
| <b>For models:</b>  | AD-45BBT, AD-48, AD-48B, AD-48BDD, AD-48C, AD-48D, AD-48DD, AD-48HY, AD-48W, AD-64, AD-64B, AD-64BBT, AD-64BDD, AD-64BTDD, AD-64C, AD-64CW, AD-64D, AD-64DD, AD-64HY, AD-72, AD-72W, EASY-500, EASY-500B, EASY-500DD, EASY-500HP, EASY-500HPWBDD, ECO-120, ECO-120B, ECO-160, ECO-160D, ECO-160I, ECO-200, ECO-200D, ECO-200H, ECO-200HD, ECO-200HI, ECO-200I, ECO-2700D, ECO-2700I, ECO-280D, ECO-280I, ECO-370D, ECO-370I, ECO-4000D, ECO-4000I, ECO-460D, ECO-460I, ECO-550D, ECO-550I, ECO-6000D...(Other models you can see in the webshop) |                 |                     |

Зип Общепит  
vsezip.ru  
+7(812)987-08-81

|   |   |                 |                     |
|---|---|-----------------|---------------------|
|  |   |                 |                     |
| 1   |   |                 |                     |
| <b>GEV No.</b>  | 560077  | <b>Ref. No.</b> | 12010265<br>Q042031 |
| <b>description</b>  | countersunk screw thread M5 L 10mm SS DIN 963/ISO 2009 Qty 20 pcs intake slotted head ø 9.2mm   |                 |                     |
| <b>For models:</b>  | ECO-1200, FE-18, FE-25, FE-4, FE-6, FE-8, FE9-05, FE9-05S, FE9-10, FF-35, FG9-05, FG9-05S, FG9-10, FI-1200, FI-900, HCG-10-11, HCG-10-21, HCG-20-11, HCG-20-21, HCG-2-10-11, HCG-2-20-11, HCG-6-11, HEI-20-11, HEM-20-11, HEP-20-11, HGP-10-21, HGP-20-21, HGV-10-11, HGV-10-21, HGV-20-11, HGV-20-21, HME-10-11, HME-10-21, HME-20-11, HME-20-21, HME-2-10-11, HME-2-20-11, HME-6-11, HMG-10-11, HMG-10-11UL, HMG-10-21, HMG-10-21UL, HMG-20-11, HMG-2-10-11, HMG-6-11, HMI-10-11, HMI-10-21, HMI-10-21UL, HMI-2-10-11...(Other models you can see in the webshop) |                 |                     |

|   |   |                 |                                |
|---|---|-----------------|--------------------------------|
|  |   |                 |                                |
| 1   |   |                 |                                |
| <b>GEV No.</b>  | 560019  | <b>Ref. No.</b> | 12009838<br>Q152015<br>Q153112 |
| <b>description</b>  | flat-headed bolt thread M3 thread L 6mm SS DIN 7985/ISO 7045 Qty 20 pcs head ø 6mm head thickness 2mm Phillips  |                 |                                |
| <b>For models:</b>  | AD-45BBT, AD-48, AD-48B, AD-48BDD, AD-48C, AD-48D, AD-48DD, AD-48HY, AD-48W, AD-64, AD-64B, AD-64BBT, AD-64BDD, AD-64BTDD, AD-64C, AD-64CW, AD-64D, AD-64DD, AD-64HY, AD-72, AD-72W, EASY-500, EASY-500B, EASY-500DD, EASY-500HP, EASY-500HPWDD, FI-30, FI-300B, FI-300R, FI-30AR, FI-30AR+DD, FI-30B, FI-30B-BT-UK, FI-30-UK, FI-48, FI-48AR, FI-48B, FI-48B-BT-UK, FI-48C, FI-48D, FI-48HY-CLINIC, FI-48W, FI-50, FI-60DD, FI-64, FI-64AR, FI-64B, FI-64B-BT-UK, FI-64C, FI-64D...(Other models you can see in the webshop) |                 |                                |

|   |   |                 |                     |
|---|---|-----------------|---------------------|
|  |   |                 |                     |
| 1   |   |                 |                     |
| <b>GEV No.</b>  | 560220  | <b>Ref. No.</b> | 12010192<br>Q042043 |
| <b>description</b>  | countersunk screw thread M6 L 20mm SS DIN 963/ISO 2009 Qty 20 pcs intake slotted head ø 11mm  |                 |                     |
| <b>For models:</b>  | CE7-41, CE9-41, CG-1002, CG-1502, CG-2002, CG-210, CG-210G, CG-310, CG-310G, CG7-11, CG7-41, CG7-61, CG9-11, CG9-41, CG9-51L, CG9-51LC, CG9-51R, CG9-51RC, CG9-61, CG9-61OP, CG9-82, CGE7-41, CGE9-41, CGF9-121D, CGF9-121I, FTG9-11L, FTG9-11L+R, FTG9-11R, FTGC9-11L, FTGC9-11L+R, FTGC9-11R, HCG-10-11, HCG-10-21, HCG-20-11, HCG-20-21, HCG-2-10-11, HCG-2-20-11, HCG-6-11, HE9-10, HE9-20, HG9-10, HG9-20, HME-10-11, HME-10-21, HME-20-11, HME-20-21, HME-2-10-11, HME-2-20-11, HME-6-11, HMI-10-11...(Other models you can see in the webshop) |                 |                     |

|   |   |                 |                     |
|---|---|-----------------|---------------------|
|  |   |                 |                     |
| 1   |   |                 |                     |
| <b>GEV No.</b>  | 560062  | <b>Ref. No.</b> | 12010278<br>Q032021 |
| <b>description</b>  | flat-headed bolt thread M4 thread L 10mm SS DIN 7985/ISO 7045 Qty 20 pcs intake Phillips head ø 8mm head thickness 2mm  |                 |                     |
| <b>For models:</b>  | ACE-061, ACE-101, ACE-102, ACE-201, ACE-202, ACG-061, ACG-101, ACG-102, ACG-201, ACG-202, AD-15, AD-15D, AD-20C-UK, AD-21, AD-21B, AD-21BDD, AD-21C, AD-21D, AD-21DD, AD-21W, AE-061, AE-061W, AE-101, AE-101W, AE-102, AE-102W, AE-201, AE-202, AG-061, AG-101, AG-102, AG-201, AG-202, APE-061, APE-061W, APE-101, APE-101W, APE-102, APE-102W, APE-201, APE-202, APG-061, APG-101, APG-102, APG-201, APG-202, BMG7-10, CG-1002, CG-1502, CG-2002...(Other models you can see in the webshop) |                 |                     |

### flat-headed bolts

|   |  |                 |                     |
|---|--|-----------------|---------------------|
|  |  |                 |                     |
| 1   |  |                 |                     |
| <b>GEV No.</b>  | 560021   | <b>Ref. No.</b> | 12010286<br>Q032011 |
| <b>description</b>  | flat-headed bolt thread M3 thread L 10mm SS DIN 7985/ISO 7045 Qty 20 pcs head ø 6mm head thickness 2mm Phillips  |                 |                     |
| <b>For models:</b>  | AD-120, AD-120B, AD-120BBTDD-UK, AD-120C, AD-120CW, AD-120HY, AD-90, AD-90BA, AD-90BBT, AD-90BDD, AD-90DD, ADE-120, ADE-120B, ECO-120, ECO-120B, FI-100, FI-100AR, FI-100B, FI-100BBT-UK, FI-120, FI-120AR+DD, FI-120B, FI-120C, FI-120HY-CLINIC, FI-120W, FI-64, FI-64AR, FI-64B, FI-64B-BT-UK, FI-64C, FI-64D, FI-64HY-CLINIC, FI-64W, FI-E-100, HGC-10-21, HGV-10-21, LABP-1000, LABP-1200, LAC-10, LAC-10MP, LAC-10MPP, LAC-14, LAC-14MP, LAC-14MPP, LAC-7, LAC-7MP, LAC-7MPP, LC-AC-10, LC-AC-10A, LC-AC-14...(Other models you can see in the webshop) |                 |                     |

|   |  |                 |          |
|---|--|-----------------|----------|
|  |  |                 |          |
| 1   |  |                 |          |
| <b>GEV No.</b>  | 560063   | <b>Ref. No.</b> | 12009862 |
| <b>description</b>  | flat-headed bolt thread M4 thread L 16mm SS DIN 7985/ISO 7045 Qty 20 pcs intake Phillips head ø 8mm head thickness 2mm |                 |          |

|   |   |                 |                     |
|---|---|-----------------|---------------------|
|  |   |                 |                     |
| 1   |   |                 |                     |
| <b>GEV No.</b>  | 560061  | <b>Ref. No.</b> | 12009876<br>Q151320 |
| <b>description</b>  | flat-headed bolt thread M4 thread L 6mm SS DIN 7985/ISO 7045 Qty 20 pcs intake Phillips head ø 8mm head thickness 2mm   |                 |                     |
| <b>For models:</b>  | ACE-061, ACE-101, ACE-102, ACE-201, ACE-202, ACG-061, ACG-101, ACG-102, ACG-201, ACG-202, AE-061, AE-061W, AE-101, AE-101W, AE-102, AE-102W, AE-201, AE-202, AG-061, AG-061W, AG-101, AG-101W, AG-102, AG-102W, AG-201, AG-202, APE-061, APE-061W, APE-101, APE-101W, APE-102, APE-102W, APE-201, APE-202, APG-061, APG-061W, APG-101, APG-101W, APG-102, APG-102W, APG-201, APG-202, BME6-05, BME7-05, BME7-10, BME9-05, BME9-05AD, BME9-05PLUS, BME9-05V-T, BME9-10...(Other models you can see in the webshop) |                 |                     |





Зип Общежит

Oval Head Screws

vsezip.ru

+7(812)987-08-81

|   |  |                 |                     |
|---|--|-----------------|---------------------|
|  |  |                 |                     |
| 1   |  |                 |                     |
| <b>GEV No.</b>  | 560068   | <b>Ref. No.</b> | 12010213<br>Q032032 |
| <b>description</b>  | flat-headed bolt thread M5 thread L 16mm SS DIN 7985/ISO 7045 Qty 20 pcs intake Phillips head ø 10mm head thickness 2mm  |                 |                     |
| <b>For models:</b>  | ACE-201, ACE-202, ACG-201, ACG-202, AD-120B, AD-120BBTDD-UK, AD-120C, AD-120HY, AD-15, AD-15D, AD-20C-UK, AD-21, AD-21B, AD-21BD, AD-21C, AD-21D, AD-21DD, AD-21W, AD-90BA, AD-90BBT, AD-90BDD, ADE-120B, AE-201, AE-202, AG-201, AG-202, APE-201, APE-202, APG-201, APG-202, COE-201, COE-202, COG-201, COG-202, ECO-120B, FI-100B, FI-100BBT-UK, FI-120B, FI-120C, FI-120HY-CLINIC, FI-80BBT-UK, GA-20, GA-20D, GA-40, GA-40D, HCG-10-11, HCG-10-21, HCG-20-11, HCG-20-21, HCG-2-10-11...(Other models you can see in the webshop) |                 |                     |

|  |  |                 |                     |
|--|--|-----------------|---------------------|
|  |  |                 |                     |
| 1  |  |                 |                     |
| <b>GEV No.</b>   | 560057   | <b>Ref. No.</b> | 12010242<br>Q152004 |
| <b>description</b>   | oval head screw thread M5 L 13mm stainless steel intake Phillips Qty 10 pcs  |                 |                     |
| <b>For models:</b>   | ACE-061, ACE-101, ACE-102, ACE-201, ACE-202, ACG-061, ACG-101, ACG-102, ACG-201, ACG-202, AD-120, AD-120B, AD-120BBTDD-UK, AD-120C, AD-120CW, AD-120HY, AD-125, AD-125HRS, AD-125-SOFT, AD-15, AD-15D, AD-20C-UK, AD-21, AD-21B, AD-21BD, AD-21C, AD-21D, AD-21DD, AD-21W, AD-45BBT, AD-48, AD-48B, AD-48BDD, AD-48C, AD-48D, AD-48DD, AD-48HY, AD-48W, AD-64, AD-64B, AD-64BBT, AD-64BDD, AD-64BTDD, AD-64C, AD-64CW, AD-64D, AD-64DD, AD-64HY, AD-72, AD-72W...(Other models you can see in the webshop) |                 |                     |

|   |   |                 |                     |
|---|---|-----------------|---------------------|
|  |   |                 |                     |
| 1   |   |                 |                     |
| <b>GEV No.</b>  | 560071  | <b>Ref. No.</b> | 12010166<br>Q032035 |
| <b>description</b>  | flat-headed bolt thread M5 thread L 30mm SS DIN 7985/ISO 7045 Qty 20 pcs intake Phillips head ø 10mm head thickness 2mm   |                 |                     |
| <b>For models:</b>  | AD-45BBT, AD-48HY, AD-64BBT, AD-64HY, CG-1002, CG-1502, FE-18, FE-25, FE-4, FE-6, FE-8, FI-30B-BT-UK, FI-48B-BT-UK, FI-48HY-CLINIC, FI-64B-BT-UK, FI-64HY-CLINIC, HCV-10-11, HCV-10-21, HCV-2-10-21, HCV-5-11, HCV-6-11, HE-10-11, HE-10-21, HE-2-10-11, HE-5-11, HE-6-11, HG-10-11, HG-10-21, HG-2-10-11, LAC-10, LAC-10MP, LAC-10MPP, LAC-14, LAC-14MP, LAC-14MPP, LAC-25, LAC-25MP, LAC-25MPP, LAC-55, LAC-55MP, LAC-55MPP, LAC-7, LAC-7MP, LAC-7MPP, LC-10, LC-14, LC-25, LC-7, LC-7A |                 |                     |

|   |  |                 |                     |
|---|--|-----------------|---------------------|
| <b>hexagonal screws</b>   |  |                 |                     |
|  |  |                 |                     |
| 1   |  |                 |                     |
| <b>GEV No.</b>  | 560311   | <b>Ref. No.</b> | 12010030<br>Q012063 |
| <b>description</b>  | hexagonal screw thread M10 thread L 20mm SS WS 17 Qty 1 pcs DIN 933 / ISO 4017   |                 |                     |
| <b>For models:</b>  | ACE-061, ACE-101, ACE-102, ACE-201, ACE-202, ACG-061, ACG-101, ACG-102, ACG-201, ACG-202, AD-120, AD-120B, AD-120C, AD-120CW, AD-48, AD-48B, AD-48BDD, AD-48C, AD-48D, AD-48DD, AD-48W, AD-64, AD-64B, AD-64BDD, AD-64BTDD, AD-64C, AD-64CW, AD-64D, AD-64DD, AD-72, AD-72W, AD-90, AD-90BA, AD-90BDD, AD-90DD, AE-061, AE-061W, AE-101, AE-101W, AE-102, AE-102W, AE-201, AE-202, AG-061, AG-061W, AG-101, AG-101W, AG-102, AG-102W, AG-201...(Other models you can see in the webshop) |                 |                     |

|   |   |                 |                     |
|---|---|-----------------|---------------------|
|  |   |                 |                     |
| 1   |   |                 |                     |
| <b>GEV No.</b>  | 560018  | <b>Ref. No.</b> | 12010157<br>Q032041 |
| <b>description</b>  | flat-headed bolt thread M6 thread L 10mm SS DIN 7985/ISO 7045 Qty 20 pcs head ø 12mm head thickness 5mm Phillips  |                 |                     |
| <b>For models:</b>  | AD-120, AD-120B, AD-120BBTDD-UK, AD-120HY, AD-90, AD-90BA, AD-90BBT, AD-90BDD, AD-90DD, ADE-120, ADE-120B, EASY-500, EASY-500B, EASY-500DD, EASY-500HP, EASY-500HPWBDD, ECO-120, ECO-120B, FI-100, FI-100AR, FI-100B, FI-100BBT-UK, FI-120, FI-120AR+DD, FI-120B, FI-120C, FI-120HY-CLINIC, FI-120W, FI-30, FI-30AR, FI-30AR+DD, FI-30B, FI-30B-BT-UK, FI-30-UK, FI-48, FI-48AR, FI-48B, FI-48B-BT-UK, FI-48C, FI-48D, FI-48HY-CLINIC, FI-48W, FI-50, FI-60DD, FI-64, FI-64AR, FI-64B, FI-64B-BT-UK, FI-64C, FI-64D...(Other models you can see in the webshop) |                 |                     |

|   |   |                 |                     |
|---|---|-----------------|---------------------|
|  |   |                 |                     |
| 1   |   |                 |                     |
| <b>GEV No.</b>  | 560081  | <b>Ref. No.</b> | 12010249<br>Q012021 |
| <b>description</b>  | hexagonal screw thread M4 thread L 10mm SS WS 7 Qty 20 pcs DIN 933 / ISO 4017   |                 |                     |
| <b>For models:</b>  | ACE-061, ACE-101, ACE-102, ACE-201, ACE-202, ACG-061, ACG-101, ACG-102, ACG-201, ACG-202, AE-061, AE-061W, AE-101, AE-101W, AE-102, AE-102W, AE-201, AE-202, AG-061, AG-061W, AG-101, AG-101W, AG-102, AG-102W, AG-201, AG-202, APE-061, APE-061W, APE-101, APE-101W, APE-102, APE-102W, APE-201, APE-202, APG-061, APG-061W, APG-101, APG-101W, APG-102, APG-102W, APG-201, APG-202, CG-2000, CG-2000-2P, CG-2005, CG-210, CG-210G, CG-3005, CG-310, CG-310G...(Other models you can see in the webshop) |                 |                     |

|   |   |                 |         |
|---|---|-----------------|---------|
|  |   |                 |         |
| 1   |   |                 |         |
| <b>GEV No.</b>  | 560355  | <b>Ref. No.</b> | Q062031 |
| <b>description</b>  | flat-headed bolt thread M5 thread L 10mm SS DIN 84/ISO 1207 Qty 1 pcs intake slotted head ø 8.3mm head thickness 3.2mm  |                 |         |
| <b>For models:</b>  | FI-1200, FI-300B, FI-300R, FI-650R, FI-900, HCV-10-11, HCV-10-21, HCV-2-10-21, HCV-5-11, HCV-6-11, HE-10-11, HE-10-21, HE-2-10-11, HE-5-11, HE-6-11, HME-10-11, HME-10-21, HME-20-11, HME-2-10-11, HME-6-11, HMI-10-11, HMI-10-11UL, HMI-10-21, HMI-10-21UL, HMI-2-10-11, HMI-6-11, HMI-6-11UL, HMM-10-11, HMM-10-11UL, HMM-10-21, HMM-10-21UL, HMM-20-11, HMM-20-11UL, HMM-2-10-11, HMM-6-11, HMM-6-11UL, HMP-10-11, HMP-10-21, HMP-20-11, HMP-2-10-11, HMP-6-11, LC-10, LC-14, LC-7, LC-7A, LF-AC-25, LF-AC-25MP, LF-AC-25MPP, LF-AC-55, LF-AC-55MP...(Other models you can see in the webshop) |                 |         |

Зип Общепит

vsezip.ru

87(812)987-08-81

|   |   |                 |                     |
|---|---|-----------------|---------------------|
|  |   |                 |                     |
| 1   |   |                 |                     |
| <b>GEV No.</b>  | 560083  | <b>Ref. No.</b> | 12010238<br>Q012031 |
| <b>description</b>  | hexagonal screw thread M5 thread L 10mm SS WS 8 Qty 20 pcs DIN 933 / ISO 4017   |                 |                     |
| <b>For models:</b>  | ACE-061, ACE-101, ACE-102, ACE-201, ACE-202, ACG-061, ACG-101, ACG-102, ACG-201, ACG-202, AD-120, AD-120B, AD-120BBTDD-UK, AD-120C, AD-120CW, AD-120HY, AD-20C-UK, AD-21B, AD-21BDD, AD-21C, AD-21DD, AD-21W, AD-45BBT, AD-48, AD-48B, AD-48BDD, AD-48C, AD-48D, AD-48DD, AD-48HY, AD-48W, AD-64, AD-64B, AD-64BDD, AD-64BBT, AD-64BDD, AD-64BTDD, AD-64C, AD-64CW, AD-64D, AD-64DD, AD-64HY, AD-72, AD-72W, AD-90, AD-90BA, AD-90BBT, AD-90BDD, AD-90DD, ADE-120, ADE-120B...(Other models you can see in the webshop) |                 |                     |

|   |   |                 |                     |
|---|---|-----------------|---------------------|
|  |   |                 |                     |
| 1   |   |                 |                     |
| <b>GEV No.</b>  | 560086  | <b>Ref. No.</b> | 12010202<br>Q012041 |
| <b>description</b>  | hexagonal screw thread M6 thread L 10mm SS WS 10 Qty 20 pcs DIN 933 / ISO 4017  |                 |                     |
| <b>For models:</b>  | AD-120, AD-120B, AD-120BBTDD-UK, AD-120C, AD-120CW, AD-120HY, AD-45BBT, AD-48, AD-48B, AD-48BDD, AD-48C, AD-48D, AD-48DD, AD-48HY, AD-48W, AD-64, AD-64B, AD-64BBT, AD-64BDD, AD-64BTDD, AD-64C, AD-64CW, AD-64D, AD-64DD, AD-64HY, AD-72, AD-72W, AD-90, AD-90BA, AD-90BBT, AD-90BDD, AD-90DD, ADE-120, ADE-120B, BME9-05, BME9-10, BMG7-10, BMG9-05, BMG9-10, CE6-41, CE7-41, CE7-41Q, CE9-41, CE9-41AD, CE9-41PLUS, CG-1002, CG-1502, CG-2000, CG-2000-2P, CG-2002...(Other models you can see in the webshop) |                 |                     |

|   |  |                 |                     |
|---|--|-----------------|---------------------|
|  |  |                 |                     |
| 2   |  |                 |                     |
| <b>GEV No.</b>  | 560254   | <b>Ref. No.</b> | 12018360<br>R725057 |
| <b>description</b>  | hexagonal screw thread M5 thread L 30mm SS WS 8 Qty 20 pcs DIN 933 / ISO 4017                                      |                 |                     |
| <b>For models:</b>  | HCG-10-11, HCG-10-21, HCG-2-10-11, HCG-6-11, HMG-10-11, HMG-10-11UL, HMG-10-21, HMG-10-21UL, HMG-2-10-11, HMG-6-11 |                 |                     |

|   |  |                 |                        |
|---|--|-----------------|------------------------|
|  |  |                 |                        |
| 1   |  |                 |                        |
| <b>GEV No.</b>  | 560079   | <b>Ref. No.</b> | 12037772<br>RT10060761 |
| <b>description</b>  | hexagonal screw thread M6 thread L 12mm SS WS 10 Qty 20 pcs DIN 933 / ISO 4017 |                 |                        |

|  |   |                 |                     |
|--|---|-----------------|---------------------|
|  |   |                 |                     |
| 1  |   |                 |                     |
| <b>GEV No.</b>   | 560253  | <b>Ref. No.</b> | 12010083<br>Q011338 |
| <b>description</b>   | hexagonal screw thread M5 thread L 60mm SS WS 8 Qty 1 pcs DIN 933 / ISO 4017  |                 |                     |
| <b>For models:</b>   | FG6-05, FG6-10, FTG7-05L, FTG7-05R, FTG7-10L, FTG7-10L+R, FTG7-10R, FTG9-05L, FTG9-05L-AD, FTG9-05PLUS-CL, FTG9-05PLUS-CR, FTG9-05PLUS-L, FTG9-05PLUS-R, FTG9-05R, FTG9-05R-AD, FTG9-05VL, FTG9-05VR, FTG9-10L, FTG9-10L+R, FTG9-10L+R-AD, FTG9-10L-AD, FTG9-10PLUS-CL, FTG9-10PLUS-CLR, FTG9-10PLUS-CR, FTG9-10PLUS-L, FTG9-10PLUS-LR, FTG9-10PLUS-R, FTG9-10R, FTG9-10R-AD, FTG9-10VL, FTG9-10VL+R, FTG9-10VR, FTG9-11L, FTG9-11L+R, FTG9-11R, FTGC7-05L, FTGC7-10L, FTGC9-05L, FTGC9-05L-AD, FTGC9-05R, FTGC9-05R-AD, FTGC9-10L, FTGC9-10L+R, FTGC9-10L+R-AD, FTGC9-10L-AD, FTGC9-10R, FTGC9-10R-AD, FTGC9-11L, FTGC9-11L+R, FTGC9-11R |                 |                     |

|  |   |                 |                     |
|--|---|-----------------|---------------------|
|  |   |                 |                     |
| 1  |   |                 |                     |
| <b>GEV No.</b>   | 524118  | <b>Ref. No.</b> | 12010186<br>Q012042 |
| <b>description</b>   | hexagonal screw thread M6 thread L 16mm SS WS 10 Qty 1 pcs DIN 933 / ISO 4017   |                 |                     |
| <b>For models:</b>   | ACE-061, ACE-101, ACE-102, ACE-201, ACE-202, ACG-061, ACG-101, ACG-102, ACG-201, ACG-202, AD-120, AD-120B, AD-120BBTDD-UK, AD-120C, AD-120CW, AD-120HY, AD-15, AD-15D, AD-20C-UK, AD-21, AD-21B, AD-21BDD, AD-21C, AD-21D, AD-21DD, AD-21W, AD-45BBT, AD-48, AD-48B, AD-48BDD, AD-48C, AD-48D, AD-48DD, AD-48HY, AD-48W, AD-64, AD-64B, AD-64BBT, AD-64BDD, AD-64BTDD, AD-64C, AD-64CW, AD-64D, AD-64DD, AD-64HY, AD-72, AD-72W, AD-90, AD-90BA, AD-90BBT...(Other models you can see in the webshop) |                 |                     |

|   |  |                 |                        |
|---|--|-----------------|------------------------|
|  |  |                 |                        |
| 1   |  |                 |                        |
| <b>GEV No.</b>  | 560448   | <b>Ref. No.</b> | 12036376<br>RT10080753 |
| <b>description</b>  | hexagonal screw thread M5 thread L 8mm SS WS 8 Qty 1 pcs head thickness 4mm DIN 933 / ISO 4017 |                 |                        |

|   |   |                 |                     |
|---|---|-----------------|---------------------|
|  |   |                 |                     |
| 1   |   |                 |                     |
| <b>GEV No.</b>  | 560088  | <b>Ref. No.</b> | 12010180<br>Q012043 |
| <b>description</b>  | hexagonal screw thread M6 thread L 20mm SS WS 10 Qty 20 pcs DIN 933 / ISO 4017  |                 |                     |
| <b>For models:</b>  | ACE-061, ACE-101, ACE-102, ACG-061, ACG-101, ACG-102, AE-061, AE-061W, AE-101, AE-101W, AE-102, AE-102W, AG-061, AG-061W, AG-101, AG-101W, AG-102, AG-102W, APE-061, APE-061W, APE-101, APE-101W, APE-102, APE-102W, APG-061, APG-061W, APG-101, APG-101W, APG-102, APG-102W, BME9-05, BME9-10, BMG9-05, BMG9-10, CE7-41, CE7-41Q, CE9-41, CG-1002, CG-1502, CG7-11, CG7-31D, CG7-31I, CG7-41, CG7-41H, CG7-51, CG7-61, CG7-61H, CG9-10, CG9-11, CG9-11AD...(Other models you can see in the webshop) |                 |                     |







Зип Общепит

vsezip.ru

+7(812)987-08-81

|   |  |                 |                     |
|---|--|-----------------|---------------------|
|  |  |                 |                     |
| <b>GEV No.</b>  | 560089   | <b>Ref. No.</b> | 12010153<br>Q012044 |
| <b>description</b>  | hexagonal screw thread M6 thread L 25mm SS WS 10 Qty 20 pcs DIN 933 / ISO 4017   |                 |                     |
| <b>For models:</b>  | AD-120, AD-120B, AD-120BBTDD-UK, AD-120C, AD-120CW, AD-120HY, AD-90, AD-90BA, AD-90BBT, AD-90BDD, AD-90DD, ADE-120, ADE-120B, CE9-41, CG-1002, CG-1502, CG-2000, CG-2000-2P, CG-2002, CG-2005, CG-210, CG-210G, CG-3005, CG-310, CG-310G, CG7-20, CG-7200, CG7-40, CG-7400, CG7-41, CG-7415, CG7-61, CG-7615, CG9-20, CG9-40, CG9-41, CG9-51L, CG9-51LC, CG9-51R, CG9-51RC, CG9-60, CG9-61, CG9-82, CGB7-61, CGE7-41, CGE9-41, COG-061, COG-101, ECO-120, ECO-120B...(Other models you can see in the webshop) |                 |                     |

|   |  |                 |                     |
|---|--|-----------------|---------------------|
|  |  |                 |                     |
| <b>GEV No.</b>  | 560252   | <b>Ref. No.</b> | 12010115<br>Q012046 |
| <b>description</b>  | hexagonal screw thread M6 thread L 40mm SS WS 10 Qty 20 pcs DIN 933 / ISO 4017   |                 |                     |
| <b>For models:</b>  | AD-45BBT, AD-48, AD-48B, AD-48C, AD-48D, AD-48DD, AD-48HY, AD-48W, AD-64, AD-64B, AD-64BBT, AD-64BTDD, AD-64C, AD-64CW, AD-64D, AD-64DD, AD-64HY, AD-72, AD-72W, EASY-500, EASY-500B, EASY-500DD, EASY-500HP, EASY-500HPWBDD, ECO-160, ECO-1600, ECO-160D, ECO-160I, ECO-200, ECO-200D, ECO-200H, ECO-200HD, ECO-200HI, ECO-200I, ECO-2300, ECO-280D, ECO-280I, ECO-3000, ECO-370D, ECO-370I, ECO-460D, ECO-460I, ECO-550D, ECO-550I, FI-160, FI-1600, FI-160D, FI-160I, FI-200, FI-200D...(Other models you can see in the webshop) |                 |                     |

|   |   |                 |                                   |
|---|---|-----------------|-----------------------------------|
|  |   |                 |                                   |
| <b>GEV No.</b>  | 503122  | <b>Ref. No.</b> | 12010112<br>Q012051<br>Q012051000 |
| <b>description</b>  | hexagonal screw thread M8 thread L 10mm SS WS 13 Qty 1 pcs DIN 933 / ISO 4017 |                 |                                   |

|   |  |                 |                     |
|---|--|-----------------|---------------------|
|  |  |                 |                     |
| <b>GEV No.</b>  | 506175   | <b>Ref. No.</b> | 12008844<br>X152809 |
| <b>description</b>  | hexagonal screw thread M8 thread L 14mm SS WS 13 Qty 20 pcs head thickness 3mm DIN 933 / ISO 4017  |                 |                     |
| <b>For models:</b>  | SBE7-10, SBE9-10, SBE9-10I, SBE9-10IM, SBE9-10IMS, SBE9-10IS, SBE9-10M, SBE9-10MS, SBE9-10S, SBE9-10USMC, SBE9-15IM, SBE9-15IMS, SBE9-15M, SBE9-15MS, SBG7-10, SBG9-10, SBG9-10I, SBG9-10IM, SBG9-10IMS, SBG9-10IS, SBG9-10M, SBG9-10MS, SBG9-10S, SBG9-15IM, SBG9-15IMS |                 |                     |

|   |  |                 |                     |
|---|--|-----------------|---------------------|
|  |  |                 |                     |
| <b>GEV No.</b>  | 550682   | <b>Ref. No.</b> | 12010076<br>Q012053 |
| <b>description</b>  | hexagonal screw thread M8 thread L 20mm SS WS 13 Qty 1 pcs DIN 933 / ISO 4017  |                 |                     |
| <b>For models:</b>  | AD-120, AD-120B, AD-120BBTDD-UK, AD-120C, AD-120CW, AD-120HY, AD-90, AD-90BA, AD-90BBT, AD-90BDD, AD-90DD, ADE-120, ADE-120B, CE-410, CG-110, CG-9110, CGB7-61H, CGB7-61R, CGB7-61RH, ECO-120, ECO-120B, ECO-160, ECO-1600, ECO-160D, ECO-160I, ECO-200, ECO-200D, ECO-200H, ECO-200HD, ECO-200HI, ECO-200I, ECO-2300, ECO-2700D, ECO-2700I, ECO-280D, ECO-280I, ECO-3000, ECO-370D, ECO-370I, ECO-4000D, ECO-4000I, ECO-460D, ECO-460I, ECO-550D, ECO-550I, ECO-6000D, ECO-6000I, FI-100, FI-100AR, FI-100B...(Other models you can see in the webshop) |                 |                     |

|   |   |                 |                        |
|---|---|-----------------|------------------------|
|  |   |                 |                        |
| <b>GEV No.</b>  | 560205  | <b>Ref. No.</b> | 12036562<br>RT10080766 |
| <b>description</b>  | hexagonal screw thread M8 thread L 30mm SS WS 13 Qty 1 pcs DIN 933 / ISO 4017 |                 |                        |

|  |   |                 |                     |
|--|---|-----------------|---------------------|
|  |   |                 |                     |
| <b>GEV No.</b>   | 506446  | <b>Ref. No.</b> | 12010056<br>Q012056 |
| <b>description</b>   | hexagonal screw thread M8 thread L 40mm SS WS 13 Qty 1 pcs DIN 933 / ISO 4017   |                 |                     |
| <b>For models:</b>   | ACE-061, ACE-101, ACE-102, ACE-201, ACE-202, ACG-061, ACG-101, ACG-102, ACG-201, ACG-202, AE-061, AE-061W, AE-101, AE-101W, AE-102, AE-102W, AE-201, AE-202, AG-061, AG-061W, AG-101, AG-101W, AG-102, AG-102W, AG-201, AG-202, APE-061, APE-061W, APE-101, APE-101W, APE-102, APE-102W, APE-201, APE-202, APG-061, APG-061W, APG-101, APG-101W, APG-102, APG-102W, APG-201, APG-202, COE-102, COE-202, COG-102, COG-201, COG-202, ECO-1600, ECO-2300, ECO-3000...(Other models you can see in the webshop) |                 |                     |

|   |  |                 |                        |
|---|--|-----------------|------------------------|
|  |  |                 |                        |
| <b>GEV No.</b>  | 550528   | <b>Ref. No.</b> | 12040516<br>RT10052000 |
| <b>description</b>  | safety screw thread M5 WS 8 Qty 10 pcs L 8mm head ø 11mm |                 |                        |

cylinder head bolts  
DIN 912/ISO 4762

|   |  |                 |                        |
|---|--|-----------------|------------------------|
|  |  |                 |                        |
| <b>GEV No.</b>  | 530454   | <b>Ref. No.</b> | 12038252<br>RT10040665 |
| <b>description</b>  | cylinder head bolt thread M4 thread L 6mm L 9.5mm WS 3 SS Qty 1 pcs intake internal hexagon DIN 912/ISO 4762 |                 |                        |

Зип, Общепит

DIN 913/ISO 4026

vsezip.ru

+7(812)987-08-81



|                    |   |                 |                     |
|--------------------|---|-----------------|---------------------|
| <b>GEV No.</b>     | 520455  | <b>Ref. No.</b> | 12038360<br>Q052053 |
| <b>description</b> | screw thread M8 thread L 20mm WS 6 SS Qty 1 pcs DIN 913/ISO 4026  |                 |                     |
| <b>For models:</b> | CE-15, CE-9, SBE7-10, SBE9-10, SBE9-10I, SBE9-10IM, SBE9-10IMS, SBE9-10IS, SBE9-10M, SBE9-10MS, SBE9-10S, SBE9-15IM, SBE9-15IMS, SBG7-10, SBG9-10, SBG9-10I, SBG9-10IM, SBG9-10IMS, SBG9-10IS, SBG9-10M, SBG9-10MS, SBG9-10S, SBG9-15IM, SBG9-15IMS |                 |                     |



|                    |  |                 |  |
|--------------------|--|-----------------|--|
| <b>GEV No.</b>     | 560380   | <b>Ref. No.</b> | 12010084<br>12018750<br>Q052046<br>Q152033 |
| <b>description</b> | cylinder head bolt thread M6 L 40mm thread L 25mm WS 5 SS Qty 1 pcs DIN 912/ISO 4762   |                 |  |
| <b>For models:</b> | ACG-061, ACG-101, ACG-102, ACG-201, ACG-202, AG-061, AG-061W, AG-101, AG-101W, AG-102, AG-102W, AG-201, AG-202, APG-061, APG-061W, APG-101, APG-101W, APG-102, APG-102W, APG-201, APG-202, ECO-1200, FI-1200, FI-120W, FI-200W, FI-200WL, FI-200WR, FI-80W, FI-900, LAC-25, LAC-25MP, LAC-25MPP, LAC-55, LAC-55MP, LAC-55MPP, LC-25, LC-AC-25, LC-E-25, LC-V-25, LF-25MPP, LF-AC-25, LF-AC-25MP, LF-AC-25MPP, LF-AC-55, LF-AC-55MP, LF-AC-55MPP, LF-E-25, LF-E-25MP, LF-E-25MPP, LF-E-55...(Other models you can see in the webshop) |                 |  |

## side bolts



|                    |  |                 |                     |
|--------------------|--|-----------------|---------------------|
| <b>GEV No.</b>     | 560038   | <b>Ref. No.</b> | 12010148<br>Q152017 |
| <b>description</b> | side bolts thread M6 L 13mm Qty 20 pcs intake Phillips head ø 15mm   |                 |                     |
| <b>For models:</b> | BME9-05, BME9-10, BMG9-05, BMG9-10, CE7-41, CE9-41, CG-1002, CG-1502, CG-2000, CG-2000-2P, CG-2002, CG-2002P, CG-2005, CG-210, CG-210G, CG-300S, CG-310, CG-310G, CG7-11, CG7-41, CG7-61, CG9-11, CG9-20, CG9-40, CG9-41, CG9-51L, CG9-51LC, CG9-51R, CG9-51RC, CG9-60, CG9-61, CG9-82, CGE7-198, CGE7-202, CGE7-41, CGE9-41, CGF9-121D, CGF9-121I, CGP9-11, ECO-120, ECO-120B, ECO-160, ECO-160D, ECO-160I, ECO-200, ECO-200D, ECO-200H, ECO-200HD, ECO-200HI, ECO-200I...(Other models you can see in the webshop) |                 |                     |



|                    |  |                 |                     |
|--------------------|--|-----------------|---------------------|
| <b>GEV No.</b>     | 560037   | <b>Ref. No.</b> | 12010129<br>Q152022 |
| <b>description</b> | side bolts thread M6 L 10mm SS Qty 20 pcs intake Phillips head ø 15mm  |                 |                     |
| <b>For models:</b> | CE6-41, CE7-41, CE7-41Q, CE9-41, CE9-41AD, CE9-41PLUS, CG-1002, CG-1502, CG-2002, CG-2002P, CG-210, CG-210G, CG-310, CG-310G, CG6-41, CG7-11, CG7-31D, CG7-31I, CG7-41, CG7-41H, CG7-51, CG7-61, CG7-61H, CG9-11, CG9-11AD, CG9-11PLUS, CG9-31PLUS-D, CG9-31PLUS-I, CG9-41, CG9-41AD, CG9-41AD-H, CG9-41H, CG9-41PLUS, CG9-41PLUS-H, CG9-51L, CG9-51LC, CG9-51R, CG9-51RC, CG9-61, CG9-61AD, CG9-61AD-H, CG9-61H, CG9-61OP, CG9-61PLUS, CG9-61PLUS-H, CG9-82, CG9-82AD, CG9-82PLUS, CGE6-41, CGE7-41...(Other models you can see in the webshop) |                 |                     |



|                    |  |                 |                     |
|--------------------|--|-----------------|---------------------|
| <b>GEV No.</b>     | 560022   | <b>Ref. No.</b> | 12010279<br>Q132054 |
| <b>description</b> | grub screw thread M6 L 12mm DIN 913/ISO 4026 WS 3 Qty 20 pcs   |                 |                     |
| <b>For models:</b> | CG-2002, CG-2002P, CG7-20H, CG7-30D, CG7-30I, CG7-31D, CG7-31I, CG7-40, CG7-40H, CG7-41, CG7-41H, CG7-50, CG7-51, CG7-60, CG7-60H, CG7-61, CG7-61H, CG9-20, CG9-20AD, CG9-20AD-H, CG9-20H, CG9-20PLUS, CG9-20PLUS-H, CG9-31PLUS-D, CG9-31PLUS-I, CG9-40, CG9-40AD, CG9-40AD-H, CG9-40H, CG9-40PLUS, CG9-40PLUS-H, CG9-41, CG9-41AD, CG9-41AD-H, CG9-41H, CG9-41PLUS, CG9-41PLUS-H, CG9-51L, CG9-51LC, CG9-51R, CG9-51RC, CG9-60, CG9-60AD, CG9-60AD-H, CG9-60H, CG9-60PLUS, CG9-60PLUS-H, CG9-61, CG9-61AD, CG9-61AD-H...(Other models you can see in the webshop) |                 |                     |



|                    |   |                 |                     |
|--------------------|---|-----------------|---------------------|
| <b>GEV No.</b>     | 560024  | <b>Ref. No.</b> | 12010197<br>Q131542 |
| <b>description</b> | grub screw thread M6 L 16mm SS DIN 913/ISO 4026 intake internal hexagon WS 3 Qty 20 pcs   |                 |                     |
| <b>For models:</b> | CG-1002, CG-1502, CG-2002, CG-2005, CG-210, CG-210G, CG-300S, CG-310, CG-310G, CG7-20, CG7-30D, CG7-30I, CG7-31D, CG7-31I, CG7-40, CG7-41, CG7-50, CG7-51, CG7-60, CG7-61, CG9-05AD, CG9-05PLUS, CG9-20, CG9-20AD, CG9-20H, CG9-20PLUS, CG9-40, CG9-40AD, CG9-40H, CG9-40PLUS, CG9-41, CG9-41AD, CG9-41PLUS, CG9-51L, CG9-51LC, CG9-51R, CG9-51RC, CG9-60, CG9-60AD, CG9-60H, CG9-60PLUS, CG9-61, CG9-61AD, CG9-61OP, CG9-61PLUS, CG9-82, CG9-82AD, CG9-82PLUS, CGB7-61, CGB7-61R...(Other models you can see in the webshop) |                 |                     |

## DIN 914/ISO 4027



|                    |  |                 |                                |
|--------------------|--|-----------------|--------------------------------|
| <b>GEV No.</b>     | 560175   | <b>Ref. No.</b> | 12010091<br>Q131504<br>Q131552 |
| <b>description</b> | grub screw thread M8 L 16mm DIN 914/ISO 4027 intake internal hexagon WS 4 Qty 1 pcs  |                 |                                |
| <b>For models:</b> | SBE7-10, SBE9-10, SBE9-10I, SBE9-10I-AD, SBE9-10I-AD-S, SBE9-10IM, SBE9-10IMS, SBE9-10IS, SBE9-10PLUS-I, SBE9-10PLUS-SI, SBE9-10S, SBE9-10USMC, SBG7-10, SBG-9040, SBG9-10, SBG9-10I, SBG9-10I-AD, SBG9-10I-AD-S, SBG9-10IS, SBG9-10PLUS-I, SBG9-10PLUS-SI, SBG9-10S |                 |                                |



|                    |   |                 |                                   |
|--------------------|---|-----------------|-----------------------------------|
| <b>GEV No.</b>     | 696737  | <b>Ref. No.</b> | 12024023<br>Z105051<br>Z105051000 |
| <b>description</b> | grub screw thread M8 L 16mm DIN 914/ISO 4027 Qty 1 pcs  |                 |                                   |
| <b>For models:</b> | ECO-160, ECO-1600, ECO-160D, ECO-160I, ECO-200, ECO-200D, ECO-200H, ECO-200HD, ECO-200HI, ECO-200I, ECO-2300, ECO-280D, ECO-280I, ECO-3000, ECO-370D, ECO-370I, ECO-460D, ECO-460I, ECO-550D, ECO-550I, FI-160, FI-1600, FI-160AR, FI-160D, FI-160I, FI-200, FI-200AR, FI-200D, FI-200H, FI-200HD, FI-200HI, FI-200I, FI-200W, FI-200WL, FI-200WR, FI-2300, FI-280D, FI-280I, FI-3000, FI-370D, FI-370I, FI-460D, FI-460I, FI-550D, FI-550I |                 |                                   |





Зип Общепит

plate nuts  
vsezip.ru

+7(812)987-08-81

DIN 916/ISO 4029

|   |  |                 |          |
|---|--|-----------------|----------|
|  |  |                 |          |
| 1   |  |                 |          |
| <b>GEV No.</b>  | 560549   | <b>Ref. No.</b> | 12010236 |
| <b>description</b>  | grub screw thread M6 L 15mm SS DIN 916/ISO 4029 intake internal hexagon WS 3 Qty 1 pcs   |                 |          |
| <b>For models:</b>  | ACE-201, ACE-202, ACG-201, ACG-202, AE-201, AE-202, AG-201, AG-202, APE-201, APE-202, APG-201, APG-202, CG9-20, CG9-20AD, CG9-20H, CG9-20PLUS, CG9-40, CG9-40AD, CG9-40H, CG9-40PLUS, CG9-41, CG9-41H, CG9-51L, CG9-51LC, CG9-51R, CG9-51RC, CG9-60, CG9-60AD, CG9-60H, CG9-60PLUS, CG9-61, CG9-61H, CG9-61OP, CG9-82, CGE9-41, CGE9-41AD, CGE9-41PLUS, CGF9-120D, CGF9-120I, CGF9-121D, CGF9-121I, COE-201, COE-202, COG-201, COG-202, HEI-10-11, HEI-20-11, HEI-20-21, HEI-6-11, HEM-10-11...(Other models you can see in the webshop) |                 |          |

|  |   |                 |                     |
|--|---|-----------------|---------------------|
|  |   |                 |                     |
| 1  |   |                 |                     |
| <b>GEV No.</b>   | 560046  | <b>Ref. No.</b> | 12010134<br>Q221012 |
| <b>description</b>   | plate nut hole ø M5mm L 16mm W 10mm   |                 |                     |
| <b>For models:</b>   | AD-15, AD-15D, AD-21, AD-21B, AD-21BDD, AD-21D, AD-21DD, AD-21W, AD-45BBT, AD-48, AD-48B, AD-48BDD, AD-48C, AD-48D, AD-48DD, AD-48HY, AD-48W, AD-64, AD-64B, AD-64BBT, AD-64BDD, AD-64C, AD-64CW, AD-64D, AD-64DD, AD-64HY, AD-72, AD-72W, EASY-500, EASY-500B, EASY-500DD, EASY-500HP, EASY-500HPWBDD, ECO-1200, FI-1200, FI-30, FI-300B, FI-300R, FI-30AR, FI-30AR+DD, FI-30B, FI-30B-BT-UK, FI-30-UK, FI-48, FI-48AR, FI-48B, FI-48B-BT-UK, FI-48C, FI-48D, FI-48HY-CLINIC...(Other models you can see in the webshop) |                 |                     |

knurled screws

|   |  |                 |                     |
|---|--|-----------------|---------------------|
|  |  |                 |                     |
| 1   |  |                 |                     |
| <b>GEV No.</b>  | 505034   | <b>Ref. No.</b> | 12009829<br>Q152016 |
| <b>description</b>  | Thumb screw thread M5 thread L 7mm ø 20mm H 3mm SS   |                 |                     |
| <b>For models:</b>  | AD-120, AD-120B, AD-120BBTDD-UK, AD-120C, AD-120CW, AD-120HY, AD-15, AD-15D, AD-20C-UK, AD-21, AD-21B, AD-21BDD, AD-21C, AD-21D, AD-21DD, AD-21W, AD-45BBT, AD-48, AD-48B, AD-48BDD, AD-48C, AD-48D, AD-48DD, AD-48HY, AD-48W, AD-64, AD-64B, AD-64BBT, AD-64BDD, AD-64BTDD, AD-64C, AD-64CW, AD-64D, AD-64DD, AD-64HY, AD-72, AD-72W, AD-90, AD-90BA, AD-90BBT, AD-90BDD, AD-90DD, ADE-120, ADE-120B, CO-110, CO-110B, CO-110BDD, CO-110DD, CO-112, CO-112B...(Other models you can see in the webshop) |                 |                     |

cap nuts

|   |  |                 |                     |
|---|--|-----------------|---------------------|
|  |  |                 |                     |
| 1   |  |                 |                     |
| <b>GEV No.</b>  | 560136   | <b>Ref. No.</b> | 12010167<br>Q212031 |
| <b>description</b>  | cap nuts thread M5 WS 8 SS Qty 20 pcs DIN/ISO DIN 1587   |                 |                     |
| <b>For models:</b>  | ECO-160, ECO-160D, ECO-160I, ECO-200, ECO-200D, ECO-200H, ECO-200HD, ECO-200HI, ECO-200I, ECO-2700D, ECO-2700I, ECO-280D, ECO-280I, ECO-370D, ECO-370I, ECO-4000D, ECO-4000I, ECO-460D, ECO-460I, ECO-550D, ECO-550I, ECO-6000D, ECO-6000I, FE9-05, FE9-05S, FE9-05USMC, FE9-10, FG9-05, FG9-05S, FG9-10, FI-160, FI-160AR, FI-160D, FI-160I, FI-200, FI-200AR, FI-200D, FI-200H, FI-200HD, FI-200HI, FI-200I, FI-200W, FI-200WL, FI-200WR, FI-2700D, FI-2700I, FI-280D, FI-280I, FI-370D, FI-370I...(Other models you can see in the webshop) |                 |                     |

miscellaneous

|   |                           |                 |                     |
|---|---------------------------|-----------------|---------------------|
|  |                           |                 |                     |
| 1   |                           |                 |                     |
| <b>GEV No.</b>  | 505140                    | <b>Ref. No.</b> | 12016848<br>Z643015 |
| <b>description</b>  | screw SS                  |                 |                     |
| <b>For models:</b>  | FI-300B, FI-300R, FI-650R |                 |                     |

|   |   |                 |   |
|---|---|-----------------|---|
|  |   |                 |   |
| 1   |   |                 |   |
| <b>GEV No.</b>  | 560137  | <b>Ref. No.</b> | 12010143<br>12034573<br>Q212040<br>RT11060360 |
| <b>description</b>  | cap nuts thread M6 WS 10 SS Qty 20 pcs DIN/ISO DIN 1587   |                 |   |
| <b>For models:</b>  | ECO-160, ECO-160D, ECO-160I, ECO-200, ECO-200D, ECO-200H, ECO-200HD, ECO-200HI, ECO-200I, ECO-2700D, ECO-2700I, ECO-280D, ECO-280I, ECO-370D, ECO-370I, ECO-4000D, ECO-4000I, ECO-460D, ECO-460I, ECO-550D, ECO-550I, ECO-6000D, ECO-6000I, FE-710, FE-720, FE-920, FF-35, FG-710, FG-720, FG-920, FI-160, FI-160AR, FI-160D, FI-160I, FI-200, FI-200AR, FI-200D, FI-200H, FI-200HD, FI-200HI, FI-200I, FI-200W, FI-200WL, FI-200WR, FI-2700D, FI-2700I, FI-280D, FI-280I, FI-370D, FI-370I...(Other models you can see in the webshop) |                 |   |

|   |  |                 |                     |
|---|--|-----------------|---------------------|
|  |  |                 |                     |
| 1   |  |                 |                     |
| <b>GEV No.</b>  | 527391   | <b>Ref. No.</b> | 12010011<br>Q151336 |
| <b>description</b>  | thread bolt thread M6 L 25mm thread L 10mm ø 7mm   |                 |                     |
| <b>For models:</b>  | BG6-05I, BG7-05, BG7-05I, BG7-10, BG7-10I, BG9-05, BG9-05I, BG9-05PF, BG9-05PI, BG9-10, BG9-10I, BG9-10PF, BG9-10PI, BME7-05, BME7-10, BME9-05, BME9-05AD, BME9-05PLUS, BME9-05V-T, BME9-10, BME9-10AD, BME9-10PLUS, BME9-10V-T, BMG7-10, BMG9-05, BMG9-05V-T, BMG9-10, BMG9-10V-T, CE7-20, CE7-20Q, CE7-40, CE7-40Q, CE7-41, CE7-41Q, CE9-20, CE9-20AD, CE9-20PLUS, CE9-40, CE9-40AD, CE9-40PLUS, CE9-41, CE9-41AD, CE9-41PLUS, CG-2000, CG-2000-2P, CG-2002, CG-2005, CG-210, CG-210G, CG-300S...(Other models you can see in the webshop) |                 |                     |

## Зип Общежит

hexagonal nuts

DIN 934 / ISO 4032/8673

vsezip.ru

7(812)987-08-81



1

|                    |  |                 |                     |
|--------------------|--|-----------------|---------------------|
| <b>GEV No.</b>     | 560138   | <b>Ref. No.</b> | 12010094<br>Q212051 |
| <b>description</b> | cap nuts thread M8 WS 13 SS Qty 20 pcs DIN/ISO DIN 1587  |                 |                     |
| <b>For models:</b> | FF-35, HCG-10-11, HCG-10-21, HCG-20-11, HCG-20-21, HCG-2-10-11, HCG-2-20-11, HCG-6-11, HEI-10-11, HEI-20-11, HEI-6-11, HEM-10-11, HEM-20-11, HEM-6-11, HEP-10-11, HEP-20-11, HEP-6-11, HGC-10-11, HGC-20-11, HGC-6-11, HGV-10-11, HGV-20-11, HME-10-11, HME-20-11, HME-6-11, HMI-10-11, HMI-10-11UL, HMI-10-21, HMI-10-21UL, HMI-2-10-11, HMI-6-11, HMI-6-11UL, HMM-10-11, HMM-10-11UL, HMM-10-21, HMM-10-21UL, HMM-20-11, HMM-20-11UL, HMM-2-10-11, HMM-2-10-11UL, HMM-4-11-USMC, HMM-6-11, HMM-6-11UL, HMP-10-11...(Other models you can see in the webshop) |                 |                     |



1

|                    |  |                 |                        |
|--------------------|--|-----------------|------------------------|
| <b>GEV No.</b>     | 560199   | <b>Ref. No.</b> | 12036825<br>RT11120110 |
| <b>description</b> | hexagonal nut thread M10 H 8mm WS 17 SS DIN/ISO DIN 934 / ISO 4032/8673 Qty 10 pcs |                 |                        |



1

|                    |  |                 |                     |
|--------------------|--|-----------------|---------------------|
| <b>GEV No.</b>     | 560131   | <b>Ref. No.</b> | 12009839<br>Q162020 |
| <b>description</b> | hexagonal nut thread M4 H 3.2mm WS 7 SS DIN/ISO DIN 934 / ISO 4032/8673 Qty 20 pcs   |                 |                     |
| <b>For models:</b> | ACE-201, ACE-202, AD-120, AD-120B, AD-120BTTDD-UK, AD-120C, AD-120CW, AD-120HY, AD-15, AD-15D, AD-20C-UK, AD-21, AD-21B, AD-21BDD, AD-21C, AD-21D, AD-21DD, AD-21W, AD-45BBT, AD-48, AD-48B, AD-48BDD, AD-48C, AD-48D, AD-48DD, AD-48HY, AD-48W, AD-64, AD-64B, AD-64BBT, AD-64BDD, AD-64C, AD-64CW, AD-64D, AD-64DD, AD-64HY, AD-72, AD-72W, AD-90, AD-90BA, AD-90BBT, AD-90BDD, AD-90DD, ADE-120, ADE-120B, AE-061, AE-061W, AE-101, AE-101W, AE-102...(Other models you can see in the webshop) |                 |                     |



1

|                    |  |                 |  |
|--------------------|--|-----------------|--|
| <b>GEV No.</b>     | 560132   | <b>Ref. No.</b> | 12010194<br>12010284<br>Q162030<br>Q163030 |
| <b>description</b> | hexagonal nut thread M5 H 4mm WS 8 SS DIN/ISO DIN 934 / ISO 4032/8673 Qty 20 pcs   |                 |  |
| <b>For models:</b> | ACE-061, ACE-101, ACE-102, ACE-201, ACE-202, ACG-061, ACG-101, ACG-102, ACG-201, ACG-202, AD-120, AD-120B, AD-120BTTDD-UK, AD-120C, AD-120CW, AD-120HY, AD-15, AD-15D, AD-20C-UK, AD-21, AD-21B, AD-21BDD, AD-21C, AD-21D, AD-21DD, AD-21W, AD-45BBT, AD-48, AD-48B, AD-48BDD, AD-48C, AD-48D, AD-48DD, AD-48HY, AD-48W, AD-64, AD-64B, AD-64BBT, AD-64BDD, AD-64BTTDD, AD-64C, AD-64CW, AD-64D, AD-64DD, AD-64HY, AD-72, AD-72W, AD-90, AD-90BA, AD-90BBT...(Other models you can see in the webshop) |                 |  |

## knurled nuts



1

|                    |  |                 |                     |
|--------------------|--|-----------------|---------------------|
| <b>GEV No.</b>     | 505173   | <b>Ref. No.</b> | 12023653<br>Z680738 |
| <b>description</b> | knurled nut  |                 |                     |
| <b>For models:</b> | AD-120, AD-120B, AD-120BTTDD-UK, AD-120C, AD-120CW, AD-120HY, ADE-120, ADE-120B, ECO-120, ECO-1200, ECO-120B, FI-100, FI-100AR, FI-100B, FI-100BBT-UK, FI-120, FI-1200, FI-120AR+DD, FI-120B, FI-120C, FI-120HY-CLINIC, FI-120W, FI-80BBT-UK, FI-900, FI-E-100, LABP-1000, LABP-1200, MF-120 |                 |                     |



1

|                    |   |                 |   |
|--------------------|---|-----------------|---|
| <b>GEV No.</b>     | 505171  | <b>Ref. No.</b> | 12017466<br>12020831<br>12024375<br>Z200705 |
| <b>description</b> | knurled nut thread M14x1 ø 35mm H 5mm SS  |                 |   |
| <b>For models:</b> | AD-45BBT, AD-48, AD-48B, AD-48BDD, AD-48C, AD-48D, AD-48DD, AD-48HY, AD-48W, AD-64, AD-64B, AD-64BBT, AD-64BDD, AD-64BTTDD, AD-64C, AD-64CW, AD-64D, AD-64DD, AD-64HY, AD-72, AD-72W, AD-90, AD-90BA, AD-90BBT, AD-90BDD, AD-90DD, EASY-500, EASY-500B, EASY-500DD, EASY-500HP, EASY-500HPBDD, FI-30, FI-30AR, FI-30AR+DD, FI-30B, FI-30B-BT-UK, FI-30-UK, FI-48, FI-48AR, FI-48B, FI-48B-BT-UK, FI-48C, FI-48D, FI-48HY-CLINIC, FI-48W, FI-50, FI-60DD, FI-64, FI-64AR, FI-64B...(Other models you can see in the webshop) |                 |   |





Зип Общепит

vsezip.ru

(812) 987-08-81

|  |   |                 |                                   |
|--|---|-----------------|-----------------------------------|
|  <p>1</p> |   |                 |                                   |
| <b>GEV No.</b>   | 511212  | <b>Ref. No.</b> | 12010255<br>Q162010<br>Q163140000 |
| <b>description</b>   | hexagonal nut thread M6 H 5mm WS 10 SS DIN/ISO DIN 934 / ISO 4032/8673 Qty 1 pcs  |                 |                                   |
| <b>For models:</b>   | ACE-061, ACE-101, ACE-102, ACE-201, ACE-202, ACG-061, ACG-101, ACG-102, ACG-201, ACG-202, AD-120, AD-120B, AD-120BBTDD-UK, AD-120C, AD-120CW, AD-120HY, AD-15, AD-15D, AD-20C-UK, AD-21, AD-21B, AD-21BDD, AD-21C, AD-21D, AD-21DD, AD-21W, AD-45BBT, AD-48, AD-48B, AD-48BDD, AD-48C, AD-48D, AD-48DD, AD-48HY, AD-48W, AD-64, AD-64B, AD-64BBT, AD-64BDD, AD-64BTDD, AD-64C, AD-64CW, AD-64D, AD-64DD, AD-64HY, AD-72, AD-72W, AD-90, AD-90BA, AD-90BBT...(Other models you can see in the webshop) |                 |                                   |

|  |   |                 |          |
|--|---|-----------------|----------|
|  <p>1</p> |   |                 |          |
| <b>GEV No.</b>   | 560140  | <b>Ref. No.</b> | 12009897 |
| <b>description</b>   | hexagonal nut thread M4 H 4.8mm SS WS 7 Qty 20 pcs DIN/ISO DIN 985 self-locking |                 |          |
| <b>For models:</b>   | AD-64BTDD   |                 |          |

|  |  |                 |   |
|--|--|-----------------|---|
|  <p>2</p> |  |                 |   |
| <b>GEV No.</b>   | 560134   | <b>Ref. No.</b> | 12010210<br>12037260<br>Q162050<br>RT11080260 |
| <b>description</b>   | hexagonal nut thread M8 H 6.5mm WS 13 SS DIN/ISO DIN 934 / ISO 4032/8673 Qty 20 pcs  |                 |   |
| <b>For models:</b>   | ACE-061, ACE-101, ACE-102, ACE-201, ACE-202, ACG-061, ACG-101, ACG-102, ACG-201, ACG-202, AD-120, AD-120B, AD-120BBTDD-UK, AD-120C, AD-120CW, AD-120HY, AD-45BBT, AD-48, AD-48B, AD-48BDD, AD-48C, AD-48D, AD-48DD, AD-48HY, AD-48W, AD-64, AD-64B, AD-64BBT, AD-64BDD, AD-64BTDD, AD-64C, AD-64CW, AD-64D, AD-64DD, AD-64HY, AD-72, AD-72W, AD-90, AD-90BA, AD-90BBT, AD-90BDD, AD-90DD, ADE-120, ADE-120B, AE-061, AE-061W, AE-101, AE-101W, AE-102, AE-102W...(Other models you can see in the webshop) |                 |   |

|  |   |                 |                     |
|--|---|-----------------|---------------------|
|  <p>1</p> |   |                 |                     |
| <b>GEV No.</b>   | 560142  | <b>Ref. No.</b> | 12010251<br>Q222012 |
| <b>description</b>   | hexagonal nut thread M6 H 6mm SS WS 10 Qty 20 pcs DIN/ISO DIN 985 self-locking  |                 |                     |
| <b>For models:</b>   | AD-120, AD-120B, AD-120BBTDD-UK, AD-15, AD-15D, AD-20C-UK, AD-21, AD-21B, AD-21BDD, AD-21C, AD-21D, AD-21DD, AD-21W, AD-45BBT, AD-48, AD-48B, AD-48BDD, AD-48C, AD-48D, AD-48DD, AD-48HY, AD-48W, AD-64, AD-64B, AD-64BBT, AD-64BDD, AD-64BTDD, AD-64C, AD-64CW, AD-64D, AD-64DD, AD-64HY, AD-72, AD-72W, AD-90, AD-90BA, AD-90BBT, AD-90BDD, AD-90DD, ADE-120, ADE-120B, EASY-500, EASY-500B, EASY-500DD, EASY-500HP, EASY-500HPWBDD, ECO-120, ECO-120B, ECO-160, ECO-160D...(Other models you can see in the webshop) |                 |                     |

|  |   |                 |                     |
|--|---|-----------------|---------------------|
|  <p>1</p> |   |                 |                     |
| <b>GEV No.</b>   | 505200  | <b>Ref. No.</b> | 12010027<br>Q162070 |
| <b>description</b>   | nut thread M12x1.75 H 10mm WS 19 SS DIN/ISO DIN 934 / ISO 4032/8673 Qty 1 pcs   |                 |                     |
| <b>For models:</b>   | AD-120, AD-120B, AD-120BBTDD-UK, AD-120C, AD-120CW, AD-120HY, AD-45BBT, AD-48, AD-48B, AD-48BDD, AD-48C, AD-48D, AD-48DD, AD-48HY, AD-48W, AD-64, AD-64B, AD-64BBT, AD-64BDD, AD-64BTDD, AD-64C, AD-64CW, AD-64D, AD-64DD, AD-64HY, AD-72, AD-72W, AD-90, AD-90BA, AD-90BBT, AD-90BDD, AD-90DD, ADE-120, ADE-120B, EASY-500, EASY-500B, EASY-500DD, EASY-500HP, EASY-500HPWBDD, ECO-120, ECO-1200, ECO-120B, ECO-160, ECO-160D, ECO-160I, ECO-200, ECO-200D, ECO-200H, ECO-200HD, ECO-200HI...(Other models you can see in the webshop) |                 |                     |

|  |  |                 |                        |
|--|--|-----------------|------------------------|
| <p>DIN 6923 / ISO 4161</p>  <p>1</p> |  |                 |                        |
| <b>GEV No.</b>   | 542383   | <b>Ref. No.</b> | 12103867<br>RT11050121 |
| <b>description</b>   | hexagonal nut thread M5 H 6mm zinc-coated steel WS 8 Qty 10 pcs for combi-steamer SCC WE |                 |                        |

|   |   |                 |                     |
|---|---|-----------------|---------------------|
| <p>DIN 439 / ISO 4035/8675</p>  <p>1</p> |   |                 |                     |
| <b>GEV No.</b>  | 507533  | <b>Ref. No.</b> | 12009948<br>Q222016 |
| <b>description</b>  | nut thread M20 H 9.5mm SS WS 29.5 Qty 1 pcs DIN/ISO DIN 439   |                 |                     |
| <b>For models:</b>  | AD-120, AD-120B, AD-120BBTDD-UK, AD-90, AD-90BA, AD-90BBT, AD-90BDD, AD-90DD, ADE-120, ADE-120B, ECO-120, ECO-120B, FI-100, FI-100AR, FI-100B, FI-100BBT-UK, FI-120, FI-120AR+DD, FI-120B, FI-120C, FI-120HY-CLINIC, FI-120W, FI-80, FI-80AR, FI-80BBT-UK, FI-80W, FI-E-100, LABP-1000, LABP-1200, LABP-800, MF-120 |                 |                     |

|  |   |                 |                        |
|--|---|-----------------|------------------------|
| <p>hexagonal nuts metric (without norm)</p>  <p>1</p> |   |                 |                        |
| <b>GEV No.</b>   | 530881  | <b>Ref. No.</b> | 12037870<br>RT11060220 |
| <b>description</b>   | hexagonal nut thread M6 H 3mm WS 10 SS Qty 25 pcs for combi-steamer CPC-Linie |                 |                        |

Зип Общепит

vsezip.ru

+7(812)987-08-81



1

|                    |  |                 |                      |
|--------------------|--|-----------------|----------------------|
| <b>GEV No.</b>     | 691860   | <b>Ref. No.</b> | 12037639<br>Z9530980 |
| <b>description</b> | nut thread M12x0.75 H 3.4mm WS 17 SS Qty 1 pcs |                 |                      |
| <b>For models:</b> | GA-20, GA-20D, GA-40, GA-40D                   |                 |                      |



1

|                    |  |                 |                                |
|--------------------|--|-----------------|--------------------------------|
| <b>GEV No.</b>     | 550261   | <b>Ref. No.</b> | 12016635<br>X163012<br>Z600603 |
| <b>description</b> | nut thread M14x1 H 4mm WS 19 SS Qty 1 pcs  |                 |                                |
| <b>For models:</b> | BG9-05, BG9-05I, BG9-10, BG9-10I, FE-710, FE-720, FE-920, FG-710, FG-720, FG-920, FI-300B, FI-300R, FI-650R, LVC-15, LVC-21, LVR-14, LVR-20, LVR-20B |                 |                                |



1

|                    |  |                 |                     |
|--------------------|--|-----------------|---------------------|
| <b>GEV No.</b>     | 101345   | <b>Ref. No.</b> | 12009877<br>Q223021 |
| <b>description</b> | nut thread M15x1 H 3mm WS 19 brass Qty 1 pcs   |                 |                     |
| <b>For models:</b> | BME7-05, BME7-10, BME9-05, BME9-05AD, BME9-05PLUS, BME9-05V-T, BME9-10, BME9-10AD, BME9-10PLUS, BME9-10V-T, FG-1-40, FG-2-80, FG7-05-1C, FG7-05-2C, FG-710, FG7-10-2C, FG7-104C, FG7-10-4C, FG-71-15, FG-720, FG-72-30, FG9-05, FG9-05-1C, FG9-05-2C, FG9-05AD, FG9-05PLUS, FG9-05PLUS-S, FG9-05S, FG9-05S-1C, FG9-05S-2C, FG9-05S-AD, FG9-10, FG9-10-2C, FG9-10-4C, FG9-10AD, FG9-10PLUS, FG-91-20, FG-920, FG-92-40, FG-940, FI-300B, FI-300R, FI-650R |                 |                     |



1

|                    |  |                 |                     |
|--------------------|--|-----------------|---------------------|
| <b>GEV No.</b>     | 691862   | <b>Ref. No.</b> | 12016713<br>Q223011 |
| <b>description</b> | nut thread M18x1.5 H 5mm WS 22 SS Qty 1 pcs                |                 |                     |
| <b>For models:</b> | FI-300B, FI-300R, FI-650R, LVR-10, LVR-14, LVR-20, LVR-20B |                 |                     |



1

|                    |  |                 |                     |
|--------------------|--|-----------------|---------------------|
| <b>GEV No.</b>     | 691861                                       | <b>Ref. No.</b> | 12016617<br>U060519 |
| <b>description</b> | nut thread M20x1 H 4mm WS 23 brass Qty 1 pcs |                 |                     |



1

|                    |  |                 |                     |
|--------------------|--|-----------------|---------------------|
| <b>GEV No.</b>     | 507536   | <b>Ref. No.</b> | 12018993<br>Q223022 |
| <b>description</b> | nut thread 1" H 3mm WS 11 brass Qty 1 pcs  |                 |                     |
| <b>For models:</b> | CG-210G, CG-310G, CG-7200, CG-7400, CG-7415, CG-7615, CG-HP-20, ECO-1600, ECO-2300, ECO-3000, FE-710, FE-720, FG-1-40, FG-2-80, FG7-05-1C, FG7-05-2C, FG-710, FG7-10-2C, FG7-104C, FG7-10-4C, FG-71-15, FG-720, FG-72-30, FG-91-20, FG-92-40, FI-100, FI-120, FI-120W, FI-1600, FI-160D, FI-160I, FI-200D, FI-200I, FI-2300, FI-280D, FI-280I, FI-3000, FI-370D, FI-370I, FI-460D, FI-460I, FI-48, FI-48B, FI-48W, FI-50, FI-5420, FI-550D, FI-550I, FI-64, FI-64B...(Other models you can see in the webshop) |                 |                     |

## hexagonal nuts inch thread



1

|                    |  |                 |                     |
|--------------------|--|-----------------|---------------------|
| <b>GEV No.</b>     | 507532   | <b>Ref. No.</b> | 12009831<br>Q223014 |
| <b>description</b> | nut thread 1" H 10mm WS 40 brass Qty 1 pcs   |                 |                     |
| <b>For models:</b> | AD-45BBT, AD-48HY, AD-64BBT, AD-64BTDD, AD-64HY, EA-SY-500HPWBDD, FE-18, FE-25, FE-710, FE-720, FE-91-20, FG-1-40, FG-2-80, FG-710, FG-720, FG-91-20, FG-920, FG-92-40, FG-940, FGCL9-05, FI-30B-BT-UK, FI-48B-BT-UK, FI-48HY-CLINIC, FI-64B-BT-UK, FI-64HY-CLINIC, HCG-10-11, HCG-10-21, HCG-20-11, HCG-20-21, HCG-2-10-11, HCG-2-20-11, HCG-6-11, HEI-10-11, HEI-20-11, HEI-6-11, HEM-10-11, HEM-20-11, HEM-6-11, HEP-10-11, HEP-20-11, HEP-6-11, HGC-10-11, HGC-20-11, HGC-6-11, HGV-10-11, HGV-20-11, HME-10-11, HME-10-21, HME-20-11, HME-20-21...(Other models you can see in the webshop) |                 |                     |



1

|                    |   |                 |  |
|--------------------|---|-----------------|--|
| <b>GEV No.</b>     | 521102  | <b>Ref. No.</b> | 12009843<br>12040388<br>Q221302<br>Q221401 |
| <b>description</b> | nut thread 1/2" H 8mm SS WS 32 Qty 1 pcs  |                 |  |
| <b>For models:</b> | BME7-05, BME7-10, BME9-05, BME9-05AD, BME9-05PLUS, BME9-05V-T, BME9-10, BME9-10AD, BME9-10PLUS, BME9-10V-T, BMG7-10, BMG9-05, BMG9-05V-T, BMG9-10, BMG9-10V-T, CE7-41, CE9-41, CGE7-173, CGE7-41, CGE9-41, CPE9-05, CPE9-05S, CPG7-05, CPG9-05, CPG9-05NC, CPG9-05S, CPG9-05SNC, ECO-1200, ECO-1600, ECO-2300, ECO-3000, FI-1200, FI-1600, FI-2300, FI-3000, FI-300B, FI-300R, FI-5420, FI-650R, FI-7630, FI-900, HE9-10, HE9-20, HPG-15, ME7-10BM, ME9-10BM, ME9-10BMS, ME9-15BM, ME9-15BM316, ME9-15BMS...(Other models you can see in the webshop) |                 |  |



1

|                    |   |                 |                     |
|--------------------|---|-----------------|---------------------|
| <b>GEV No.</b>     | 521003  | <b>Ref. No.</b> | 12039941<br>X012121 |
| <b>description</b> | nut thread 1/4" H 6.3mm chrome-plated brass WS 20 Qty 1 pcs |                 |                     |
| <b>For models:</b> | FG-71-15, FG-72-30, FG-91-20, FG-92-40                      |                 |                     |



Зип Общежит

WASHERS

spring rings

vsezip.ru

+7(812)987-08-81

|   |   |                 |                     |
|---|---|-----------------|---------------------|
|  |   |                 |                     |
| 1   |   |                 |                     |
| <b>GEV No.</b>  | 507535  | <b>Ref. No.</b> | 12009899<br>Q221324 |
| <b>description</b>  | nut thread 3/4" H 7mm WS 30 SS Qty 1 pcs  |                 |                     |
| <b>For models:</b>  | BG7-05, BG7-05I, BG7-10, BG7-10I, BG9-05, BG9-05I, BG9-05PF, BG9-05PI, BG9-10, BG9-10I, BG9-10PF, BG9-10PI, BMG7-10, BMG-9045, BMG9-05, BMG9-05V-T, BMG9-10, BMG9-10V-T, CE-410, CE9-41, CG-2000-2P, CG9-51L, CG9-51LC, CG9-51R, CG9-51RC, ECO-160, ECO-200, ECO-200H, ECO-2700D, ECO-2700I, ECO-280D, ECO-280I, ECO-370D, ECO-370I, ECO-4000D, ECO-4000I, ECO-460D, ECO-460I, ECO-550D, ECO-550I, ECO-6000D, ECO-6000I, FG-71-15, FG-72-30, FI-160, FI-160AR, FI-160D, FI-160I, FI-200, FI-200AR...(Other models you can see in the webshop) |                 |                     |

|   |   |                 |                     |
|---|---|-----------------|---------------------|
|  |   |                 |                     |
| 1   |   |                 |                     |
| <b>GEV No.</b>  | 503042  | <b>Ref. No.</b> | 12007923<br>Q223019 |
| <b>description</b>  | nut thread 3/8" H 6mm brass WS 22 Qty 1 pcs   |                 |                     |
| <b>For models:</b>  | BG6-05I, BG7-05, BG7-05I, BG7-10, BG7-10I, BG9-05, BG9-05AD, BG9-05I, BG9-05PF, BG9-05PI, BG9-05PLUS-I, BG9-10, BG9-10AD, BG9-10I, BG9-10PF, BG9-10PI, BG9-10PLUS-I, BMG7-10, BMG-9045, BMG9-05, BMG9-05V-T, BMG9-10, BMG9-10V-T, CG-1002, CG-1502, CG-2000, CG-2000-2P, CG-2002, CG-210, CG-210G, CG-310, CG-310G, CG6-41, CG7-10, CG7-11, CG-7115, CG-7200, CG7-31D, CG7-31I, CG-7400, CG7-41, CG-7415, CG7-41H, CG7-51, CG7-61, CG-7615, CG7-61H, CG9-10, CG9-10AD, CG9-10PLUS...(Other models you can see in the webshop) |                 |                     |

|   |   |                 |                     |
|---|---|-----------------|---------------------|
|  |   |                 |                     |
| 1   |   |                 |                     |
| <b>GEV No.</b>  | 514196  | <b>Ref. No.</b> | 12039127<br>Q222015 |
| <b>description</b>  | nut thread 3/8" H 8.5mm WS 22 SS Qty 1 pcs  |                 |                     |
| <b>For models:</b>  | SBE7-10, SBE9-10, SBE9-10I, SBE9-10IM, SBE9-10IMS, SBE9-10IS, SBE9-10M, SBE9-10MS, SBE9-10S, SBE9-10USMC, SBE9-15IM, SBE9-15IMS, SBG7-10, SBG9-10, SBG9-10I, SBG9-10IM, SBG9-10IMS, SBG9-10IS, SBG9-10M, SBG9-10MS, SBG9-10S, SBG9-15IM, SBG9-15IMS |                 |                     |

|   |   |                 |                     |
|---|---|-----------------|---------------------|
| <b>hexagonal nuts with PG thread</b>  |   |                 |                     |
|  |   |                 |                     |
| 1   |   |                 |                     |
| <b>GEV No.</b>  | 550578  | <b>Ref. No.</b> | 12009764<br>Q223016 |
| <b>description</b>  | nut thread PG21 H 4.6mm WS 32 nickel-plated brass Qty 1 pcs mounting ømm cable ømm  |                 |                     |
| <b>For models:</b>  | ECO-120, ECO-120B, FI-100, FI-100AR, FI-100B, FI-120, FI-120B, FI-120W, FI-30, FI-48, FI-48B, FI-48W, FI-50, FI-64, FI-64B, FI-64W, FI-72, FI-80, FI-80W, LA-13M, LA-18MP, LA-AC-10M, LA-AC-10MA, LA-AC-10MP, LA-AC-13M, LA-AC-13MA, LA-AC-13MP, LA-AC-18M, LA-AC-18MA, LA-AC-18MP, LA-AC-25M, LA-AC-25MA, LA-AC-25MP, LA-E-10M, LA-E-10MA, LA-E-10MP, LA-E-13M, LA-E-13MA, LA-E-13MP, LA-E-18M, LA-E-18MA, LA-E-18MP, LA-E-25M, LA-E-25MA, LA-E-25MP, LA-V-10M, LA-V-10MP, LA-V-13M, LA-V-13MP, LA-V-18M...(Other models you can see in the webshop) |                 |                     |

|   |  |                 |                     |
|---|--|-----------------|---------------------|
|  |  |                 |                     |
| 1   |  |                 |                     |
| <b>GEV No.</b>  | 560122   | <b>Ref. No.</b> | 12009924<br>Q262030 |
| <b>description</b>  | lock washer ID ø 5.2mm ED ø 9mm SS DIN127 Qty 20 pcs for thread M5   |                 |                     |
| <b>For models:</b>  | AD-15, AD-15D, AD-20C-UK, AD-21, AD-21B, AD-21BDD, AD-21C, AD-21D, AD-21DD, AD-21W, AD-45BBT, AD-48, AD-48B, AD-48BDD, AD-48C, AD-48D, AD-48DD, AD-48HY, AD-48W, AD-64, AD-64B, AD-64BBT, AD-64BDD, AD-64BTDD, AD-64C, AD-64CW, AD-64D, AD-64DD, AD-64HY, AD-72, AD-72W, AD-90, AD-90DD, ADE-120, ADE-120B, BG9-05AD, BG9-05PLUS-I, BG9-10AD, BG9-10PLUS-I, BME9-05, BME9-05AD, BME9-05PLUS, BME9-05V-T, BME9-10, BME9-10AD, BME9-10PLUS, BME9-10V-T, BMG7-10, BMG9-05, BMG9-05V-T...(Other models you can see in the webshop) |                 |                     |

|   |  |                 |                     |
|---|--|-----------------|---------------------|
|  |  |                 |                     |
| 1   |  |                 |                     |
| <b>GEV No.</b>  | 560123   | <b>Ref. No.</b> | 12009872<br>Q262040 |
| <b>description</b>  | lock washer ID ø 6.3mm ED ø 11mm SS DIN127 Qty 20 pcs for thread M6  |                 |                     |
| <b>For models:</b>  | ACE-061, ACE-101, ACE-102, ACE-201, ACE-202, AD-120, AD-120B, AD-120BBTDD-UK, AD-120C, AD-120CW, AD-120HY, AD-15, AD-15D, AD-20C-UK, AD-21, AD-21B, AD-21BDD, AD-21C, AD-21D, AD-21DD, AD-21W, AD-45BBT, AD-48, AD-48B, AD-48BDD, AD-48C, AD-48D, AD-48DD, AD-48HY, AD-48W, AD-64, AD-64B, AD-64BBT, AD-64BDD, AD-64BTDD, AD-64C, AD-64CW, AD-64D, AD-64DD, AD-64HY, AD-72, AD-72W, AD-90, AD-90BA, AD-90BBT, AD-90BDD, AD-90DD, ADE-120, ADE-120B, AE-061...(Other models you can see in the webshop) |                 |                     |

|   |   |                 |   |
|---|---|-----------------|---|
|  |   |                 |   |
| 1   |   |                 |   |
| <b>GEV No.</b>  | 560124  | <b>Ref. No.</b> | 12010272<br>12037421<br>Q262050<br>RT12080260 |
| <b>description</b>  | lock washer ID ø 8.3mm ED ø 15mm SS DIN127 Qty 20 pcs for thread M8   |                 |   |
| <b>For models:</b>  | AD-120, AD-120B, AD-120BBTDD-UK, AD-120C, AD-120CW, AD-120HY, AD-90, AD-90BA, AD-90BBT, AD-90BDD, AD-90DD, ADE-120, ADE-120B, CE7-20Q, CE7-40Q, CE7-41Q, CE9-20, CE9-20AD, CE9-20PLUS, CE9-40, CE9-40AD, CE9-40PLUS, CE9-41, CE9-41AD, CE9-41PLUS, CGB7-61H, CGB7-61R, CGB7-61RH, ECO-120, ECO-120B, ECO-160, ECO-1600, ECO-160D, ECO-160I, ECO-200, ECO-200D, ECO-200H, ECO-200HD, ECO-200HI, ECO-200I, ECO-2300, ECO-2700D, ECO-2700I, ECO-280D, ECO-280I, ECO-3000, ECO-370D, ECO-370I, ECO-4000D, ECO-4000I...(Other models you can see in the webshop) |                 |   |

## spring washers



|                    |   |                 |                     |
|--------------------|---|-----------------|---------------------|
| <b>GEV No.</b>     | 560056  | <b>Ref. No.</b> | 12010233<br>Q301035 |
| <b>description</b> | clamping washer nominal- $\phi$ 4mm ED $\phi$ 10mm spring steel   |                 |                     |
| <b>For models:</b> | HEI-10-11, HEI-6-11, HEM-10-11, HEM-6-11, HEP-10-11, HEP-6-11, HME-10-11, HME-10-21, HME-20-11, HME-20-21, HME-2-10-11, HME-2-20-11, HME-6-11, HMG-10-11, HMG-10-11UL, HMG-10-21, HMG-10-21UL, HMG-20-11, HMG-2-10-11, HMG-6-11, HMI-10-11, HMI-10-11UL, HMI-10-21, HMI-10-21UL, HMI-2-10-11, HMI-6-11, HMI-6-11UL, HMM-10-11, HMM-10-11UL, HMM-10-21, HMM-10-21UL, HMM-20-11, HMM-20-11UL, HMM-20-21, HMM-20-21UL, HMM-2-10-11, HMM-2-20-11, HMM-40-11-USMC, HMM-6-11, HMM-6-11UL, HMP-10-11, HMP-10-21, HMP-20-11, HMP-20-21, HMP-2-10-11, HMP-2-20-11, HMP-6-11, MFHMM-20-11 |                 |                     |



|                    |   |                 |                        |
|--------------------|---|-----------------|------------------------|
| <b>GEV No.</b>     | 560630  | <b>Ref. No.</b> | 12037727<br>RT11070100 |
| <b>description</b> | clamping washer nominal- $\phi$ 4mm ED $\phi$ 11.5mm SS thickness 0.2mm |                 |                        |

## washers

## DIN 125A



|                    |   |                 |                     |
|--------------------|---|-----------------|---------------------|
| <b>GEV No.</b>     | 560312  | <b>Ref. No.</b> | 12010235<br>Q232060 |
| <b>description</b> | plain washer ID $\phi$ 10.5mm ED $\phi$ 20mm thickness 2mm SS Qty 1 pcs DIN 125A for thread M10   |                 |                     |
| <b>For models:</b> | CG-1002, CG-1502, CG-2000, CG-2000-2P, CG-2002, CG-2002P, ECO-280D, ECO-280I, ECO-370D, ECO-370I, ECO-460D, ECO-460I, ECO-550D, ECO-550I, FI-280D, FI-280I, FI-300B, FI-300R, FI-370D, FI-370I, FI-460D, FI-460I, FI-550D, FI-550I, FI-650R, FTEC9-05USMC, FTEC9-10USMC, HCG-10-11, HCG-10-21, HCG-20-11, HCG-20-21, HCG-2-10-11, HCG-6-11, HCV-10-11, HCV-10-21, HCV-2-10-21, HCV-5-11, HCV-6-11, HE-10-11, HE-10-21, HE-2-10-11, HE-5-11, HE-6-11, HG-10-11, HG-10-21, HG-2-10-11, HME-10-11, HME-10-21, HME-20-11, HME-20-21...(Other models you can see in the webshop) |                 |                     |



|                    |   |                 |                     |
|--------------------|---|-----------------|---------------------|
| <b>GEV No.</b>     | 560111  | <b>Ref. No.</b> | 12009987<br>Q232020 |
| <b>description</b> | plain washer ID $\phi$ 4.3mm ED $\phi$ 9mm thickness 0.8mm SS Qty 20 pcs DIN 125A for thread M4   |                 |                     |
| <b>For models:</b> | ACE-061, ACE-101, ACE-102, ACE-201, ACE-202, ACG-061, ACG-101, ACG-102, ACG-201, ACG-202, AD-120, AD-120B, AD-120BTTDD-UK, AD-120C, AD-120CW, AD-120HY, AD-15, AD-15D, AD-21, AD-21B, AD-21BDD, AD-21C, AD-21D, AD-21DD, AD-21W, AD-48, AD-48B, AD-48C, AD-48D, AD-48DD, AD-64, AD-64B, AD-64BTTDD, AD-64C, AD-64D, AD-64DD, AD-72, AD-90, AD-90BA, AD-90BBT, AD-90BDD, AD-90DD, ADE-120, ADE-120B, AE-061, AE-061W, AE-101, AE-101W, AE-102, AE-102W...(Other models you can see in the webshop) |                 |                     |

Зип Общепит

vsezip.ru

7(812)987-08-81

|                    |  |                 |                     |
|--------------------|--|-----------------|---------------------|
| <b>GEV No.</b>     | 560112   | <b>Ref. No.</b> | 12009944<br>Q232030 |
| <b>description</b> | plain washer ID $\phi$ 5.3mm ED $\phi$ 10mm thickness 1mm SS Qty 20 pcs DIN 125A for thread M5   |                 |                     |
| <b>For models:</b> | ACE-061, ACE-101, ACE-102, ACE-201, ACE-202, ACG-061, ACG-101, ACG-102, ACG-201, ACG-202, AD-120, AD-120B, AD-120BTTDD-UK, AD-120C, AD-120CW, AD-120HY, AD-15, AD-15D, AD-20C-UK, AD-21, AD-21B, AD-21BDD, AD-21C, AD-21D, AD-21DD, AD-21W, AD-45BBT, AD-48, AD-48B, AD-48BDD, AD-48C, AD-48D, AD-48DD, AD-48HY, AD-48W, AD-64, AD-64B, AD-64BBT, AD-64BDD, AD-64BTTDD, AD-64C, AD-64CW, AD-64D, AD-64DD, AD-64HY, AD-72, AD-72W, AD-90, AD-90BA, AD-90BBT...(Other models you can see in the webshop) |                 |                     |



|                    |  |                 |   |
|--------------------|--|-----------------|---|
| <b>GEV No.</b>     | 560113   | <b>Ref. No.</b> | 12009868<br>12038251<br>Q232040<br>RT13060120 |
| <b>description</b> | plain washer ID $\phi$ 6.4mm ED $\phi$ 12mm thickness 1.6mm SS Qty 20 pcs DIN 125A for thread M6   |                 |   |
| <b>For models:</b> | ACE-061, ACE-101, ACE-102, ACE-201, ACE-202, ACG-061, ACG-101, ACG-102, ACG-201, ACG-202, AD-120, AD-120B, AD-120BTTDD-UK, AD-120C, AD-120CW, AD-120HY, AD-15, AD-15D, AD-20C-UK, AD-21, AD-21B, AD-21BDD, AD-21C, AD-21D, AD-21DD, AD-21W, AD-45BBT, AD-48, AD-48B, AD-48BDD, AD-48C, AD-48D, AD-48DD, AD-48HY, AD-48W, AD-64, AD-64B, AD-64BBT, AD-64BDD, AD-64BTTDD, AD-64C, AD-64CW, AD-64D, AD-64DD, AD-64HY, AD-72, AD-72W, AD-90, AD-90BA, AD-90BBT...(Other models you can see in the webshop) |                 |   |



|                    |  |                 |   |
|--------------------|--|-----------------|---|
| <b>GEV No.</b>     | 560114   | <b>Ref. No.</b> | 12010268<br>12037409<br>Q232050<br>RT13080160 |
| <b>description</b> | plain washer ID $\phi$ 8.4mm ED $\phi$ 16mm thickness 1.6mm SS Qty 20 pcs DIN 125A for thread M8   |                 |   |
| <b>For models:</b> | AD-120, AD-120B, AD-120BTTDD-UK, AD-120C, AD-120CW, AD-120HY, AD-90, AD-90BA, AD-90BBT, AD-90BDD, AD-90DD, ADE-120, ADE-120B, CE7-20Q, CE7-40Q, CE7-41Q, CE9-20, CE9-20AD, CE9-20PLUS, CE9-40, CE9-40AD, CE9-40PLUS, CE9-41, CE9-41AD, CE9-41PLUS, CG7-51, CG7-61, CG7-61H, CGB7-61, CGP9-11, CPE7-05, CPE7-05NC, CPE9-05, CPE9-05AD, CPE9-05AD-S, CPE9-05NC, CPE9-05PLUS, CPE9-05PLUS-S, CPE9-05S, CPE9-05SNC, CPG7-05, CPG7-05NC, CPG9-05, CPG9-05AD, CPG9-05AD-S, CPG9-05NC, CPG9-05PLUS, CPG9-05PLUS-S, CPG9-05S, CPG9-05SNC...(Other models you can see in the webshop) |                 |   |







Зип Общепит

vsezip.ru

81(2)987-08-81

| DIN 9021  |   |                 |                     |
|---|---|-----------------|---------------------|
|  |   |                 |                     |
| 1   |   |                 |                     |
| <b>GEV No.</b>  | 560117  | <b>Ref. No.</b> | 12010257<br>Q302022 |
| <b>description</b>  | plain washer ID ø 6.4mm ED ø 18mm thickness 1.5mm SS Qty 20 pcs<br>DIN 9021 for thread M6   |                 |                     |
| <b>For models:</b>  | ACE-061, ACE-101, ACE-102, ACE-201, ACE-202, ACG-061, ACG-101, ACG-102, ACG-201, ACG-202, AD-120, AD-120B, AD-120BTTDD-UK, AD-120C, AD-120CW, AD-120HY, AD-15, AD-15D, AD-20C-UK, AD-21, AD-21B, AD-21BDD, AD-21C, AD-21D, AD-21DD, AD-21W, AD-45BBT, AD-48, AD-48B, AD-48BDD, AD-48C, AD-48D, AD-48DD, AD-48HY, AD-48W, AD-64, AD-64B, AD-64BBT, AD-64BDD, AD-64BTDD, AD-64C, AD-64CW, AD-64D, AD-64DD, AD-64HY, AD-72, AD-72W, AD-90, AD-90BA, AD-90BBT...(Other models you can see in the webshop) |                 |                     |

|                    |  |                 |                        |
|--------------------|--|-----------------|------------------------|
| <b>GEV No.</b>     | 560580   | <b>Ref. No.</b> | 12036873<br>RT13060222 |
| <b>description</b> | plain washer ID ø 6.4mm ED ø 15mm thickness 1.5mm Qty 10 pcs |                 |                        |

|   |  |                 |            |
|---|--|-----------------|------------|
|  |  |                 |            |
| 1   |  |                 |            |
| <b>GEV No.</b>  | 506160   | <b>Ref. No.</b> | Q231450000 |
| <b>description</b>  | plain washer ID ø 8.6mm ED ø 16mm thickness 1.5mm SS Qty 1 pcs |                 |            |

miscellaneous

|   |   |                 |                     |
|---|---|-----------------|---------------------|
|  |   |                 |                     |
| 1   |   |                 |                     |
| <b>GEV No.</b>  | 529239  | <b>Ref. No.</b> | 12016722<br>T075021 |
| <b>description</b>  | flat washer ID ø 11mm ED ø 32mm thickness 0.8mm brass Qty 1 pcs |                 |                     |
| <b>For models:</b>  | HCG-6-11, HMG-6-11  |                 |                     |

|   |   |                 |                        |
|---|---|-----------------|------------------------|
|  |   |                 |                        |
| 1   |   |                 |                        |
| <b>GEV No.</b>  | 560313  | <b>Ref. No.</b> | 12035156<br>RT13280102 |
| <b>description</b>  | serrated locking washer ID ø 10mm ED ø 22mm thickness 1.5mm SS Qty 1 pcs for thread M10 |                 |                        |

tooth lock washers

DIN 6798A

|  |   |                 |                     |
|--|---|-----------------|---------------------|
|  |   |                 |                     |
| 1  |   |                 |                     |
| <b>GEV No.</b>   | 529238  | <b>Ref. No.</b> | 12016739<br>R725065 |
| <b>description</b>   | flat washer ID ø 18mm ED ø 32mm thickness 1.2mm brass Qty 1 pcs |                 |                     |
| <b>For models:</b>   | HCG-10-11, HMG-10-11  |                 |                     |

|  |   |                 |                     |
|--|---|-----------------|---------------------|
|  |   |                 |                     |
| 1  |   |                 |                     |
| <b>GEV No.</b>   | 560036  | <b>Ref. No.</b> | 12009953<br>Q242010 |
| <b>description</b>   | tooth lock washer ID ø 3.1mm ED ø 5.7mm SS Qty 10 pcs   |                 |                     |
| <b>For models:</b>   | AD-120, AD-120B, AD-120BTTDD-UK, AD-120C, AD-120CW, AD-120HY, AD-15, AD-15D, AD-20C-UK, AD-21, AD-21B, AD-21BDD, AD-21C, AD-21D, AD-21DD, AD-21W, AD-45BBT, AD-48, AD-48B, AD-48BDD, AD-48C, AD-48D, AD-48DD, AD-48HY, AD-48W, AD-64, AD-64B, AD-64BBT, AD-64BDD, AD-64BTDD, AD-64C, AD-64CW, AD-64D, AD-64DD, AD-64HY, AD-72, AD-72W, AD-90, AD-90BA, AD-90BBT, AD-90BDD, AD-90DD, ADE-120, ADE-120B, CE-15, CE-9, EASY-500, EASY-500B, EASY-500DD, EASY-500HP...(Other models you can see in the webshop) |                 |                     |

|   |   |                 |                     |
|---|---|-----------------|---------------------|
|  |   |                 |                     |
| 1   |   |                 |                     |
| <b>GEV No.</b>  | 529242  | <b>Ref. No.</b> | 12039798<br>R725034 |
| <b>description</b>  | plain washer ID ø 10mm ED ø 16mm thickness 2mm brass Qty 1 pcs        |                 |                     |
| <b>For models:</b>  | HMG-10-11, HMG-10-11UL, HMG-10-21, HMG-10-21UL, HMG-2-10-11, HMG-6-11 |                 |                     |

|   |   |                 |                     |
|---|---|-----------------|---------------------|
|  |   |                 |                     |
| 1   |   |                 |                     |
| <b>GEV No.</b>  | 560125  | <b>Ref. No.</b> | 12009928<br>Q242020 |
| <b>description</b>  | tooth lock washer ID ø 4.2mm ED ø 8mm SS DIN/ISO DIN 6798A Qty 20 pcs for thread M4   |                 |                     |
| <b>For models:</b>  | ACE-061, ACE-101, ACE-102, ACE-201, ACE-202, ACG-061, ACG-101, ACG-102, ACG-201, ACG-202, AD-120, AD-120B, AD-120BTTDD-UK, AD-120C, AD-120CW, AD-120HY, AD-15, AD-15D, AD-20C-UK, AD-21, AD-21B, AD-21BDD, AD-21C, AD-21D, AD-21DD, AD-21W, AD-45BBT, AD-48, AD-48B, AD-48BDD, AD-48C, AD-48D, AD-48DD, AD-48HY, AD-48W, AD-64, AD-64B, AD-64BDD, AD-64BTDD, AD-64C, AD-64CW, AD-64D, AD-64DD, AD-64HY, AD-72, AD-72W, AD-90, AD-90BA, AD-90BBT, AD-90BDD...(Other models you can see in the webshop) |                 |                     |

|   |  |                 |                     |
|---|--|-----------------|---------------------|
|  |  |                 |                     |
| 1   |  |                 |                     |
| <b>GEV No.</b>  | 529237   | <b>Ref. No.</b> | 12016723<br>R735011 |
| <b>description</b>  | plain washer ID ø 21mm ED ø 32mm thickness 1.2mm brass Qty 1 pcs |                 |                     |
| <b>For models:</b>  | HCG-10-21, HCG-2-10-11, HMG-10-21, HMG-2-10-11                   |                 |                     |

Зип-Общепит

slot nuts

vsezip.ru

7(812)987 08 81



1

|                    |  |                 |                     |
|--------------------|--|-----------------|---------------------|
| <b>GEV No.</b>     | 560126   | <b>Ref. No.</b> | 12009890<br>Q242030 |
| <b>description</b> | tooth lock washer ID $\varnothing$ 5.2mm ED $\varnothing$ 10mm SS DIN/ISO DIN 6798 A Qty 20 pcs for thread M5  |                 |                     |
| <b>For models:</b> | ACE-061, ACE-101, ACE-102, ACE-201, ACE-202, ACG-061, ACG-101, ACG-102, ACG-201, ACG-202, AD-120, AD-120B, AD-120BTTDD-UK, AD-120C, AD-120CW, AD-120HY, AD-15, AD-15D, AD-20C-UK, AD-21, AD-21B, AD-21BDD, AD-21C, AD-21D, AD-21DD, AD-21W, AD-45BBT, AD-48, AD-48B, AD-48BDD, AD-48C, AD-48D, AD-48DD, AD-48HY, AD-48W, AD-64, AD-64B, AD-64BBT, AD-64BDD, AD-64C, AD-64CW, AD-64D, AD-64DD, AD-64HY, AD-72, AD-72W, AD-90, AD-90BA, AD-90BBT, AD-90BDD...(Other models you can see in the webshop) |                 |                     |



1

|                    |  |                 |                     |
|--------------------|--|-----------------|---------------------|
| <b>GEV No.</b>     | 560342   | <b>Ref. No.</b> | 12009882<br>Q242040 |
| <b>description</b> | tooth lock washer ID $\varnothing$ 6.5mm ED $\varnothing$ 11mm SS Qty 1 pcs for thread M6  |                 |                     |
| <b>For models:</b> | ACE-061, ACE-101, ACE-102, ACE-201, ACE-202, ACG-061, ACG-101, ACG-102, ACG-201, ACG-202, AD-120, AD-120B, AD-120BTTDD-UK, AD-120C, AD-120CW, AD-120HY, AD-64BTTDD, AD-90, AD-90BA, AD-90BBT, AD-90BDD, AD-90DD, ADE-120, ADE-120B, AE-061, AE-061W, AE-101, AE-101W, AE-102, AE-102W, AE-201, AE-202, AG-061, AG-061W, AG-101, AG-101W, AG-102, AG-102W, AG-201, AG-202, APE-061, APE-061W, APE-101, APE-101W, APE-102, APE-102W, APE-201, APE-202, APG-061, APG-061W...(Other models you can see in the webshop) |                 |                     |

## fasteners

## mounting spigots



1

|                    |   |                 |                     |
|--------------------|---|-----------------|---------------------|
| <b>GEV No.</b>     | 524031  | <b>Ref. No.</b> | 12008693<br>X012612 |
| <b>description</b> | spigot nominal- $\varnothing$ 7mm thread M5 L 38mm  |                 |                     |
| <b>For models:</b> | BME6-05, BMG7-10, CE6-20, CE6-40, CE6-41, CG-310, CG-310G, CG6-20, CG6-40, CG6-41, CG-7615, CGE6-41, CMF6-05, CPE6-05, CV6-20, CV6-40, EN6-05, EN6-10, FE6-05, FE6-10, FE-71-15, FE-91-20, FG6-05, FG6-10, FG-71-15, FG-72-30, FG-91-20, FG-92-40, HE9-10, HE9-20, HG9-10, HG9-15, HG9-20, LA-13M, LA-18MP, LA-25M, LA-AC-10M, LA-AC-10MA, LA-AC-10MP, LA-AC-13M, LA-AC-13MA, LA-AC-13MP, LA-AC-18M, LA-AC-18MA, LA-AC-18MP, LA-AC-25M, LA-AC-25MA, LA-AC-25MP, LA-E-10M, LA-E-10MA...(Other models you can see in the webshop) |                 |                     |

1

|                    |   |                 |                     |
|--------------------|---|-----------------|---------------------|
| <b>GEV No.</b>     | 560286  | <b>Ref. No.</b> | 12023513<br>Z105014 |
| <b>description</b> | slot nut W 6mm H 6mm L 25mm   |                 |                     |
| <b>For models:</b> | ECO-160, ECO-1600, ECO-160D, ECO-160I, ECO-200, ECO-200D, ECO-200H, ECO-200HD, ECO-200HI, ECO-200I, ECO-2300, ECO-2700D, ECO-2700I, ECO-280D, ECO-280I, ECO-3000, ECO-370D, ECO-370I, ECO-4000D, ECO-4000I, ECO-460D, ECO-460I, ECO-550D, ECO-550I, ECO-6000D, ECO-6000I, FI-160, FI-1600, FI-160AR, FI-160D, FI-160I, FI-200, FI-200AR, FI-200D, FI-200H, FI-200HD, FI-200HI, FI-200I, FI-200W, FI-200WL, FI-200WR, FI-2300, FI-2700D, FI-2700I, FI-280D, FI-280I, FI-3000, FI-370D, FI-370I, FI-4000D...(Other models you can see in the webshop) |                 |                     |

## clamps

## hose clamps

## DIN 3017 - W2



1

|                    |  |                 |                        |
|--------------------|--|-----------------|------------------------|
| <b>GEV No.</b>     | 520111   | <b>Ref. No.</b> | 12035874<br>RT20660205 |
| <b>description</b> | hose clamp $\varnothing$ 10-16mm width 9mm Qty 10 pcs DIN 3017 |                 |                        |



1

|                    |   |                 |   |
|--------------------|---|-----------------|---|
| <b>GEV No.</b>     | 520114  | <b>Ref. No.</b> | 12010023<br>12035505<br>Q881304<br>RT20660506 |
| <b>description</b> | hose clamp $\varnothing$ 20-32mm width 9mm Qty 10 pcs DIN 3017  |                 |   |
| <b>For models:</b> | AD-120B, AD-120BTTDD-UK, AD-120C, AD-120HY, AD-125, AD-125HRS, AD-125-SOFT, AD-505, AD-505-SOFT, AD-90BA, AD-90BBT, AD-90BDD, ADE-120B, APE-061, APE-061W, APE-101, APE-101W, APE-102, APE-102W, APE-201, APE-202, APG-061, APG-061W, APG-101, APG-101W, APG-102, APG-102W, APG-201, APG-202, BME9-05, BME9-10, BMG9-10, CO-110B, CO-110BDD, CO-112B, CO-112BDD, CO-170B, CO-170BDD, CO-172B, CO-172BDD, CO-500B, CO-500BDD, CO-501B, CO-501BDD, CO-502B, CO-502BDD, CO-502W, COP-173, COP-173B, COP-173BDD...(Other models you can see in the webshop) |                 |   |





Зип Общепит

vsezip.ru

(812)987-08-81

|  |  |                 |                    |
|--|--|-----------------|--------------------|
|  <p>1</p> |  |                 |                    |
| <b>GEV No.</b>   | 520115   | <b>Ref. No.</b> | 1200997<br>Q881305 |
| <b>description</b>   | hose clamp ø 25-40mm width 9mm Qty 10 pcs DIN 3017   |                 |                    |
| <b>For models:</b>   | AD-45BBT, AD-48, AD-48B, AD-48BDD, AD-48C, AD-48D, AD-48DD, AD-48HY, AD-48W, AD-505, AD-64, AD-64B, AD-64BBT, AD-64BDD, AD-64BTDD, AD-64C, AD-64CW, AD-64D, AD-64DD, AD-64HY, AD-72, AD-72W, AE-201, AE-202, AG-061, AG-061W, AG-101, AG-101W, AG-102, AG-102W, AG-201, AG-202, APE-061, APE-061W, APE-101, APE-101W, APE-102, APE-102W, APE-201, APE-202, APG-061, APG-061W, APG-101, APG-101W, APG-102, APG-102W, APG-201, APG-202, BME7-05, BME7-10...(Other models you can see in the webshop) |                 |                    |

|   |  |                 |   |
|---|--|-----------------|---|
|  <p>1</p> |  |                 |   |
| <b>GEV No.</b>  | 520110   | <b>Ref. No.</b> | 12010047<br>12037543<br>GH51X003<br>Q881308 |
| <b>description</b>  | hose clamp ø 8-12mm width 9mm Qty 10 pcs DIN 3017  |                 |   |
| <b>For models:</b>  | AD-120, AD-120B, AD-120BBTDD-UK, AD-120C, AD-120CW, AD-120HY, AD-15, AD-15D, AD-20C-UK, AD-21, AD-21B, AD-21BDD, AD-21C, AD-21D, AD-21DD, AD-21W, AD-48, AD-48B, AD-48BDD, AD-48C, AD-48D, AD-48DD, AD-48W, AD-64, AD-64B, AD-64BDD, AD-64C, AD-64CW, AD-64D, AD-64DD, AD-72, AD-72W, AD-90, AD-90BA, AD-90BBT, AD-90BDD, AD-90DD, ADE-120, ADE-120B, CO-110, CO-110B, CO-110BDD, CO-110DD, CO-112, CO-112B, CO-112BDD, CO-112DD, CO-142W, CO-142WDD, CO-170...(Other models you can see in the webshop) |                 |   |

|  |   |                 |   |
|--|---|-----------------|---|
|  <p>2</p> |   |                 |   |
| <b>GEV No.</b>   | 520118  | <b>Ref. No.</b> | 12009933<br>12036496<br>Q881324<br>RT20660300 |
| <b>description</b>   | hose clamp ø 50-70mm width 9mm Qty 5 pcs DIN 3017   |                 |   |
| <b>For models:</b>   | AD-45BBT, AD-48, AD-48B, AD-48BDD, AD-48C, AD-48D, AD-48DD, AD-48HY, AD-48W, AD-505, AD-505-SOFT, AD-64, AD-64B, AD-64BBT, AD-64BDD, AD-64BTDD, AD-64C, AD-64CW, AD-64D, AD-64DD, AD-64HY, AD-72, AD-72W, CO-500, CO-500B, CO-500BDD, CO-500DD, CO-501, CO-501B, CO-501BDD, CO-501DD, CO-501-SOFT, CO-502B, CO-502BDD, CO-502DD, CO-502W, COP-503, COP-503B, COP-503BDD, COP-503DD, COP-503-SOFT, COP-504, COP-504B, COP-504BDD, COP-504DD, COP-504W, EASY-500, EASY-500B, EASY-500DD, EASY-500HP...(Other models you can see in the webshop) |                 |   |

|   |   |                 |   |
|---|---|-----------------|---|
|  <p>1</p> |   |                 |   |
| <b>GEV No.</b>  | 520117  | <b>Ref. No.</b> | 12009962<br>12035446<br>Q881306000<br>Q881307<br>RT20660504 |
| <b>description</b>  | hose clamp stainless steel ø 40-60mm width 9mm Qty 5 pcs DIN 3017   |                 |   |
| <b>For models:</b>  | ACE-061, ACE-101, ACE-102, ACE-201, ACE-202, ACG-061, ACG-101, ACG-102, ACG-201, ACG-202, AD-120, AD-120B, AD-120BBTDD-UK, AD-120C, AD-120CW, AD-120HY, AD-125, AD-125HRS, AD-125-SOFT, AD-15, AD-15D, AD-20C-UK, AD-21, AD-21B, AD-21BDD, AD-21C, AD-21D, AD-21DD, AD-21W, AD-45BBT, AD-48, AD-48B, AD-48BDD, AD-48C, AD-48D, AD-48DD, AD-48HY, AD-48W, AD-505, AD-505-SOFT, AD-64, AD-64B, AD-64BBT, AD-64BDD, AD-64BTDD, AD-64C, AD-64CW, AD-64D, AD-64DD, AD-64HY...(Other models you can see in the webshop) |                 |   |

|  |   |                 |                        |
|--|---|-----------------|------------------------|
|  <p>1</p> |   |                 |                        |
| <b>GEV No.</b>   | 520119  | <b>Ref. No.</b> | 12036081<br>RT20660516 |
| <b>description</b>   | hose clamp ø 60-80mm width 9mm Qty 5 pcs DIN 3017 |                 |                        |

|  |   |                 |                     |
|--|---|-----------------|---------------------|
| <p>DIN 3017 - W4</p>  <p>1</p> |   |                 |                     |
| <b>GEV No.</b>   | 520120  | <b>Ref. No.</b> | 12010036<br>Q881302 |
| <b>description</b>   | hose clamp SS W4 ø 12-20mm width 9mm Qty 1 pcs DIN 3017   |                 |                     |
| <b>For models:</b>   | ACE-061, ACE-101, ACE-102, ACE-201, ACE-202, ACG-061, ACG-101, ACG-102, ACG-201, ACG-202, AD-120, AD-120B, AD-120BBTDD-UK, AD-120C, AD-120CW, AD-120HY, AD-125, AD-125HRS, AD-125-SOFT, AD-15, AD-15D, AD-20C-UK, AD-21, AD-21B, AD-21BDD, AD-21C, AD-21D, AD-21DD, AD-21W, AD-45BBT, AD-48, AD-48B, AD-48BDD, AD-48C, AD-48D, AD-48DD, AD-48HY, AD-48W, AD-505, AD-505-SOFT, AD-64, AD-64B, AD-64BBT, AD-64BDD, AD-64BTDD, AD-64C, AD-64CW, AD-64D, AD-64DD, AD-64HY...(Other models you can see in the webshop) |                 |                     |

|  |   |                 |   |
|--|---|-----------------|---|
|  <p>1</p> |   |                 |   |
| <b>GEV No.</b>   | 520454  | <b>Ref. No.</b> | 12009914<br>12036146<br>Q881326<br>RT20660505 |
| <b>description</b>   | hose clamp ø 70-90mm width 9mm Qty 5 pcs DIN 3017   |                 |   |
| <b>For models:</b>   | ACE-202, ACG-202, AE-202, AG-202, APE-202, APG-202, COE-202, ECO-2700D, ECO-2700I, ECO-280D, ECO-280I, ECO-370D, ECO-370I, ECO-4000D, ECO-4000I, ECO-460D, ECO-460I, ECO-550D, ECO-550I, ECO-6000D, ECO-6000I, FI-2700D, FI-2700I, FI-280D, FI-280I, FI-370D, FI-370I, FI-4000D, FI-4000I, FI-460D, FI-460I, FI-550D, FI-550I, FI-6000D, FI-6000I, HMG-10-21-STACKING, LA-13M, LA-18MP, LA-25M, LAC-25, LAC-25MP, LAC-25MPP, LAC-55, LAC-55MP, LAC-55MPP, LB-AC-10M, LB-E-10M, LB-V-10M, LC-10, LC-14...(Other models you can see in the webshop) |                 |   |

Зип Общепит

vsezip.ru

+7(812)987-08-81

## double wire clamps



1

|                    |  |                 |                        |
|--------------------|--|-----------------|------------------------|
| <b>GEV No.</b>     | 511658   | <b>Ref. No.</b> | 12035627<br>RT20660533 |
| <b>description</b> | hose clamp ø 10mm wire gauge ø 1.3mm steel Qty 5 pcs |                 |                        |



1

|                    |  |                 |                        |
|--------------------|--|-----------------|------------------------|
| <b>GEV No.</b>     | 520916   | <b>Ref. No.</b> | 12036614<br>RT20660518 |
| <b>description</b> | hose clamp ø 30mm wire gauge ø 2.7mm chrome-plated steel Qty 1 pcs |                 |                        |



1

|                    |  |                 |                        |
|--------------------|--|-----------------|------------------------|
| <b>GEV No.</b>     | 560570   | <b>Ref. No.</b> | 12036450<br>RT20660519 |
| <b>description</b> | hose clamp ø 35.6mm wire gauge ø 3mm Qty 1 pcs |                 |                        |



1

|                    |   |                 |                     |
|--------------------|---|-----------------|---------------------|
| <b>GEV No.</b>     | 505190  | <b>Ref. No.</b> | 12009972<br>Q901307 |
| <b>description</b> | hose clamp ø 36-42mm wire gauge ø 3mm zinc-coated steel Qty 1 pcs   |                 |                     |
| <b>For models:</b> | AD-15, AD-15D, AD-20C-UK, AD-21, AD-21B, AD-21BDD, AD-21C, AD-21D, AD-21DD, AD-21W, ECO-1200, FI-1200, FI-900, HEI-10-21, HEM-10-21, HGC-10-21, HGC-20-21, HGV-10-21, LVC-12, LVC-15, LVC-15D, LVC-21, LVC-21B, LVC-21C, LVC-21D, LVC-21W, LVR-10, LVR-14, LVR-14D, LVR-20, LVR-20B, LVR-20D, MF-21 |                 |                     |



1

|                    |   |                 |                     |
|--------------------|---|-----------------|---------------------|
| <b>GEV No.</b>     | 505191  | <b>Ref. No.</b> | 12007966<br>Q901308 |
| <b>description</b> | hose clamp ø 52-59mm wire gauge ø 3.5mm Qty 1 pcs   |                 |                     |
| <b>For models:</b> | AD-45BBT, AD-48, AD-48B, AD-48BDD, AD-48C, AD-48D, AD-48DD, AD-48HY, AD-48W, AD-64, AD-64B, AD-64BBT, AD-64BDD, AD-64BTDD, AD-64C, AD-64CW, AD-64D, AD-64DD, AD-64HY, AD-72, AD-72W, EASY-500, EASY-500B, EASY-500DD, EASY-500HP, FI-30, FI-30AR, FI-30AR+DD, FI-30B, FI-30B-BT-UK, FI-30-UK, FI-48, FI-48AR, FI-48B, FI-48B-BT-UK, FI-48C, FI-48D, FI-48HY-CLINIC, FI-48W, FI-50, FI-60DD, FI-64, FI-64AR, FI-64B, FI-64B-BT-UK, FI-64C, FI-64D, FI-64HY-CLINIC, FI-64W, FI-72...(Other models you can see in the webshop) |                 |                     |



1

|                    |   |                 |                        |
|--------------------|---|-----------------|------------------------|
| <b>GEV No.</b>     | 505351  | <b>Ref. No.</b> | 12036929<br>RT20660527 |
| <b>description</b> | wire clamp ø 11.6-12.2mm wire gauge ø 1.5mm zinc-coated steel Qty 100 pcs |                 |                        |



1

|                    |  |                 |                        |
|--------------------|--|-----------------|------------------------|
| <b>GEV No.</b>     | 505358   | <b>Ref. No.</b> | 12036811<br>RT20660530 |
| <b>description</b> | wire clamp ø 14.4-15.1mm wire gauge ø 1.8mm zinc-coated steel Qty 50 pcs |                 |                        |

## double wire clamps with screw



1

|                    |  |                 |                     |
|--------------------|--|-----------------|---------------------|
| <b>GEV No.</b>     | 505079   | <b>Ref. No.</b> | 12025195<br>Z400903 |
| <b>description</b> | hose clamp ø 186-172mm Qty 1 pcs   |                 |                     |
| <b>For models:</b> | AD-15, AD-15D, AD-20C-UK, AD-21, AD-21B, AD-21BDD, AD-21C, AD-21D, AD-21DD, AD-21W, CO-350, CO-350-B, CO-350-B-DD, CO-350-COLD, CO-350-COLD-B, CO-350-COLD-B-DD, CO-350-COLD-DD, CO-350-DD, CO-352-COLD, CO-352-COLD-B, CO-352-COLD-B-DD, CO-352-COLD-DD, CO-400, CO-400-B, CO-400-B-DD, CO-400-COLD, CO-400-COLD-B, CO-400-COLD-B-DD, CO-400-COLD-DD, CO-400-DD, CO-400-SOFT, CO-402-COLD, CO-402-COLD-B, CO-402-COLD-B-DD, CO-402-COLD-DD, CO-402W, LVC-12, LVC-15, LVC-15D, LVC-21, LVC-21B, LVC-21C, LVC-21D, LVC-21W, LVR-10, LVR-14, LVR-14D, LVR-20, LVR-20B, LVR-20D...(Other models you can see in the webshop) |                 |                     |



1

|                    |   |                 |                     |
|--------------------|---|-----------------|---------------------|
| <b>GEV No.</b>     | 505080  | <b>Ref. No.</b> | 12023841<br>Z200908 |
| <b>description</b> | hose clamp ø 235-215mm Qty 1 pcs  |                 |                     |
| <b>For models:</b> | AD-45BBT, AD-48, AD-48B, AD-48BDD, AD-48C, AD-48D, AD-48DD, AD-48HY, AD-48W, AD-64, AD-64B, AD-64BBT, AD-64BDD, AD-64BTDD, AD-64C, AD-64CW, AD-64D, AD-64DD, AD-64HY, AD-72, AD-72W, EASY-500, EASY-500B, EASY-500DD, EASY-500HP, FI-30, FI-30AR, FI-30AR+DD, FI-30B, FI-30B-BT-UK, FI-30-UK, FI-48, FI-48AR, FI-48B, FI-48B-BT-UK, FI-48C, FI-48D, FI-48HY-CLINIC, FI-48W, FI-50, FI-60DD, FI-64, FI-64AR, FI-64B, FI-64B-BT-UK, FI-64C, FI-64D, FI-64HY-CLINIC, FI-64W, FI-72...(Other models you can see in the webshop) |                 |                     |



Зип Общежит

cotter pins

vsezip.ru

+7(812)987-08-81

|   |  |                 |                     |
|---|--|-----------------|---------------------|
|  |  |                 |                     |
| 1   |  |                 |                     |
| <b>GEV No.</b>  | 691398   | <b>Ref. No.</b> | 12010283<br>Q371028 |
| <b>description</b>  | roll pin ø 3mm L 16mm  |                 |                     |
| <b>For models:</b>  | CG-1002, CG-1502, CG-2002, CG-2002P, CG9-20AD-H, CG9-20H, CG9-20PLUS-H, CG9-40, CG9-40AD, CG9-40AD-H, CG9-40H, CG9-40PLUS, CG9-40PLUS-H, CG9-41, CG9-41AD, CG9-41AD-H, CG9-41H, CG9-41PLUS, CG9-41PLUS-H, CG9-51L, CG9-51LC, CG9-51R, CG9-51RC, CG9-60, CG9-60AD, CG9-60AD-H, CG9-60H, CG9-60PLUS, CG9-60PLUS-H, CG9-61, CG9-61AD, CG9-61AD-H, CG9-61H, CG9-61OP, CG9-61PLUS, CG9-61PLUS-H, CG9-82, CG9-82AD, CG9-82PLUS, CGE9-41, CGE9-41AD, CGE9-41PLUS, LF-AC-55, LF-AC-55MP, LF-AC-55MPP, LF-E-55, LF-E-55MP, LF-E-55MPP, LF-V-55, LF-V-55MP...(Other models you can see in the webshop) |                 |                     |

|  |   |                 |                     |
|--|---|-----------------|---------------------|
|  |   |                 |                     |
| 1  |   |                 |                     |
| <b>GEV No.</b>   | 551305  | <b>Ref. No.</b> | 12010292<br>Q352001 |
| <b>description</b>   | cotter pin ø 2mm L 23mm SS Qty 20 pcs   |                 |                     |
| <b>For models:</b>   | ACE-201, ACE-202, ACG-201, ACG-202, AE-201, AE-202, AG-201, AG-202, APE-201, APE-202, APG-201, APG-202, COE-201, COE-202, COG-201, COG-202, ECO-120, ECO-120B, ECO-160, ECO-160D, ECO-160I, ECO-200, ECO-200D, ECO-200H, ECO-200HD, ECO-200HI, ECO-200I, ECO-2700D, ECO-2700I, ECO-280D, ECO-280I, ECO-370D, ECO-370I, ECO-4000D, ECO-4000I, ECO-460D, ECO-460I, ECO-550D, ECO-550I, ECO-6000D, ECO-6000I, FI-100, FI-100AR, FI-100B, FI-120, FI-120B, FI-120W, FI-160, FI-160AR, FI-160D...(Other models you can see in the webshop) |                 |                     |

|   |  |                 |                     |
|---|--|-----------------|---------------------|
|  |  |                 |                     |
| 2   |  |                 |                     |
| <b>GEV No.</b>  | 691725   | <b>Ref. No.</b> | 12010273<br>Q371026 |
| <b>description</b>  | roll pin ø 4.5mm L 15mm  |                 |                     |
| <b>For models:</b>  | AE-102W, APE-061, APE-061W, APE-101, APE-101W, APE-102, APE-102W, APE-201, APE-202, APG-061, APG-061W, APG-101, APG-101W, APG-102, APG-102W, APG-201, APG-202, CG-1002, CG-1502, CG-2000, CG-2000-2P, CG-2002, CG-2002P, CG-2005, CG-210, CG-210G, CG-3005, CG-310, CG-310G, CG7-20, CG-7200, CG7-20H, CG7-30D, CG7-30I, CG7-31D, CG7-31I, CG7-40, CG-7400, CG7-40H, CG7-41, CG-7415, CG7-41H, CG7-50, CG7-51, CG7-60, CG7-60H, CG7-61, CG-7615, CG7-61H, CG9-05AD...(Other models you can see in the webshop) |                 |                     |

|  |   |                 |                                   |
|--|---|-----------------|-----------------------------------|
|  |   |                 |                                   |
| 1  |   |                 |                                   |
| <b>GEV No.</b>   | 551461  | <b>Ref. No.</b> | 12010169<br>Q352024<br>Q352024000 |
| <b>description</b>   | cotter pin ø 4mm L 25mm stainless steel Qty 10 pcs DIN 94 |                 |                                   |

|   |   |                 |  |
|---|---|-----------------|--|
|  |   |                 |  |
| 1   |   |                 |  |
| <b>GEV No.</b>  | 504451  | <b>Ref. No.</b> | 12009828<br>12021015<br>Q362000<br>Z105026 |
| <b>description</b>  | roll pin ø 6.3mm L 50mm SS  |                 |  |
| <b>For models:</b>  | ECO-160, ECO-1600, ECO-160D, ECO-160I, ECO-200, ECO-200D, ECO-200H, ECO-200HD, ECO-200HI, ECO-200I, ECO-2300, ECO-280D, ECO-280I, ECO-3000, ECO-370D, ECO-370I, ECO-460D, ECO-460I, ECO-550D, ECO-550I, FI-160, FI-1600, FI-160AR, FI-160D, FI-160I, FI-200, FI-200AR, FI-200D, FI-200H, FI-200HD, FI-200HI, FI-200I, FI-200W, FI-200WL, FI-200WR, FI-2300, FI-280D, FI-280I, FI-3000, FI-370D, FI-370I, FI-460D, FI-460I, FI-550D, FI-550I |                 |  |

## consumables

### sealants and adhesives

#### food-grade silicones

|   |  |                 |                        |
|---|--|-----------------|------------------------|
|  |  |                 |                        |
| 1   |  |                 |                        |
| <b>GEV No.</b>  | 890106   | <b>Ref. No.</b> | 12032727<br>RT50060200 |
| <b>description</b>  | silicone TB40 transparent tube 90g -40 up to +160°C  |                 |                        |
| <b>description</b>  | Tomabond - TB40 - tube 90g - transparent<br>For flexible sealing in drinking water, food, water and industrial kitchen areas. Securely joins glass, metal, wood-based materials, ceramic and plastics with high adhesion (1.1 N/mm <sup>2</sup> ).<br>Fungicide-, algicide- and solvent-free, ageing-resistant.<br>Temperature-resistant from -40 °C to +160 °C<br>Tested and approved by KTW / KSW. |                 |                        |



Зип-Общепит

vsezip.ru

+7(812)987-08-81

screw fixings



|                    |   |                 |                        |
|--------------------|---|-----------------|------------------------|
| <b>GEV No.</b>     | 890137  | <b>Ref. No.</b> | 12030041<br>RT20010042 |
| <b>description</b> | screw fixing LOCTITE 243 medium-strength bottle 5ml   |                 |                        |
| <b>description</b> | LOCTITE® 243™ - bottle 5ml<br>Is a general purpose threadlocker of medium bond strength. This threadlocker secures and seal bolts, nuts and studs to prevent loosening due to vibration. The product works on all metals, including passive substrates such as stainless steel, aluminium and plated surfaces. It is proven to be tolerant of minor contamination due to industrial oils, e.g. engine oils, corrosion prevention oils and cutting fluids. |                 |                        |

cleaning agents

combi-steamer detergents/descalers

*Notice: Articles labelled 'DANGEROUS GOODS' are delivered by road through a forwarder for reasons of safety and are charged separately!*



|                    |                                       |                 |                        |
|--------------------|---------------------------------------|-----------------|------------------------|
| <b>GEV No.</b>     | 802186                                | <b>Ref. No.</b> | 12029940<br>RT90060136 |
| <b>description</b> | detergent for combi-steamer 10 litres |                 |                        |

descalers



|                    |                                      |                 |                        |
|--------------------|--------------------------------------|-----------------|------------------------|
| <b>GEV No.</b>     | 890045                               | <b>Ref. No.</b> | 12030129<br>RT60060110 |
| <b>description</b> | descaler RATIONAL descaler 10 litres |                 |                        |

fuses

fine fuses



|                    |   |                 |                     |
|--------------------|---|-----------------|---------------------|
| <b>GEV No.</b>     | 358671  | <b>Ref. No.</b> | 12039844<br>R663101 |
| <b>description</b> | fine fuse size ø5x20mm 1A fast-acting rated 250V Qty 10 pcs   |                 |                     |
| <b>For models:</b> | HME-10-11, HME-10-21, HME-20-11, HME-20-21, HME-2-10-11, HME-2-20-11, HME-6-11, HMP-10-11, HMP-10-21, HMP-20-11, HMP-20-21, HMP-2-10-11, HMP-6-11 |                 |                     |



|                    |   |                 |   |
|--------------------|---|-----------------|---|
| <b>GEV No.</b>     | 358677  | <b>Ref. No.</b> | 12024333<br>12035393<br>P184011<br>RT30190112 |
| <b>description</b> | fine fuse size ø5x20mm 4A fast-acting rated 250V Qty 10 pcs   |                 |   |
| <b>For models:</b> | CE-15, CE-9, ECO-160, ECO-1600, ECO-160D, ECO-160I, ECO-200, ECO-200D, ECO-200H, ECO-200HD, ECO-200HI, ECO-200I, ECO-2300, ECO-280D, ECO-280I, ECO-3000, ECO-370D, ECO-370I, ECO-460D, ECO-460I, ECO-550D, ECO-550I, FF-35, FI-160, FI-1600, FI-160AR, FI-160D, FI-160I, FI-200, FI-200AR, FI-200D, FI-200H, FI-200HD, FI-200HI, FI-200I, FI-200W, FI-2300, FI-280D, FI-280I, FI-3000, FI-370D, FI-370I, FI-460D, FI-460I, FI-550D, FI-550I, GA-20, GA-40, HCV-10-11, HCV-10-21...<br>(Other models you can see in the webshop) |                 |   |



|                    |   |                 |                        |
|--------------------|---|-----------------|------------------------|
| <b>GEV No.</b>     | 358603  | <b>Ref. No.</b> | 12034888<br>RT30190120 |
| <b>description</b> | fine fuse size ø5x20mm 2A slow-acting rated 250V Qty 10 pcs |                 |                        |

ø6.3x32mm 250V



|                    |  |                 |                        |
|--------------------|--|-----------------|------------------------|
| <b>GEV No.</b>     | 358792   | <b>Ref. No.</b> | 12035115<br>RT40010225 |
| <b>description</b> | fine fuse size ø6.3x32mm 10A slow-acting rated 250V Qty 10 pcs |                 |                        |



|                    |   |                 |                        |
|--------------------|---|-----------------|------------------------|
| <b>GEV No.</b>     | 358791  | <b>Ref. No.</b> | 12037374<br>RT40010224 |
| <b>description</b> | fine fuse size ø6.3x32mm 6.3A slow-acting rated 250V Qty 10 pcs |                 |                        |

Зип-Общепит

gauge pieces (NEOZED)

screw locks

D0-system (NEOZED)



1

|                    |   |                 |                        |
|--------------------|---|-----------------|------------------------|
| <b>GEV No.</b>     | 358043  | <b>Ref. No.</b> | 12033846<br>RT30190401 |
| <b>description</b> | fuse size D01 16A rated 250/400V E14 ø 11mm L 36mm Qty 10 pcs |                 |                        |



1

|                    |   |                 |                        |
|--------------------|---|-----------------|------------------------|
| <b>GEV No.</b>     | 358047  | <b>Ref. No.</b> | 12032709<br>RT30190405 |
| <b>description</b> | fuse size D02 63A rated 250/400V E18 ø 15mm L 36mm Qty 10 pcs |                 |                        |



1

|                    |                                       |                 |                        |
|--------------------|---------------------------------------|-----------------|------------------------|
| <b>GEV No.</b>     | 358064                                | <b>Ref. No.</b> | 12037278<br>RT40011238 |
| <b>description</b> | gauge piece size D02 suitable for 16A |                 |                        |

+7(812)987-08-81

vsezip.ru



Зип Общепит

vsezip.ru

+7(812)987-08-81

|   |          |                                |          |
|---|----------|--------------------------------|----------|
| <b>A</b>  |          |                                |          |
| alarm devices                                   | 45       | double wire clamps with screw  | 338, 356 |
| appliance hose reels                            | 319      | drain fittings                 | 335      |
| axial fans                                      | 85       | drain hoses                    | 323      |
|   |          | drain pumps                    | 102      |
|   |          | drain systems and wash basins  | 335      |
| <b>B</b>  |          | <b>E</b>                       |          |
| ball valves                                     | 331      | edgemount latches              | 254      |
| ballasts  | 39       | electric accessories           | 108      |
| bar burners                                     | 152      | electrodes                     | 81       |
| bi-metal thermostats                            | 17, 18   | electromagnetic closer         | 252      |
| boiling pan gaskets                             | 295      | electronic controllers         | 52       |
| booster pumps I                                 | 102      | electronic magnets             | 114      |
| booster pumps II                                | 103      | end caps and plugs             | 273      |
|   |          | energy regulators              | 17       |
|   |          | espagnolette locks             | 254      |
|   |          | evaporators                    | 309      |
| <b>C</b>  |          | <b>F</b>                       |          |
| cable glands                                    | 108, 108 | fans                           | 85       |
| cables  | 108      | fasteners                      | 354      |
| cam switches                                    | 30       | fastening material             | 339      |
| cap nuts  | 347      | female fastons                 | 110      |
| capillary pipes                                 | 308      | filter driers                  | 307      |
| castors and bumper angles                       | 273      | filter weights                 | 321      |
| clamps  | 336, 354 | filters                        | 106      |
| cleaning agents                                 | 359      | fine fuses                     | 359      |
| cleaning tools                                  | 339      | fittings                       | 329      |
| coffee grounds drawers                          | 317      | flat-headed bolts              | 342      |
| coil heating elements                           | 8        | flow sensors                   | 82       |
| cold air circulating fans (complete)            | 88       | fluorescent lamps              | 38, 38   |
| combi-steamer detergents/descalers              | 359      | foam rubber gaskets            | 303      |
| compressors                                     | 82       | food-grade silicones           | 336, 358 |
| condensators & interference suppression filters | 105      | forced air burners             | 157      |
| connection cables                               | 110      | formed hoses                   | 325      |
| consumables                                     | 358      | fuses                          | 107, 359 |
| contactors                                      | 45       |                                |          |
| container filters                               | 321      | <b>G</b>                       |          |
| control equipment                               | 35       | gas burners                    | 143      |
| control thermostats                             | 18       | gas control valves             | 126      |
| cooling aggregates                              | 82       | gas hoses                      | 173      |
| core probes                                     | 55       | gas lines                      | 170      |
| cotter pins                                     | 358      | gas nozzles                    | 160      |
| countersunk screws                              | 341      | gas taps                       | 114      |
| cross flow fans                                 | 88       | gas thermostats                | 122      |
| cylinder head bolts                             | 345      | gaskets for control panels     | 295      |
|   |          | gaskets for heated units       | 290      |
|   |          | gaskets for tray rack trolleys | 294      |
|   |          | gaskets for wash arm support   | 307      |
|   |          | gastronorm                     | 317      |
|   |          | grates                         | 279      |
|   |          | group 1                        | 308      |
|   |          | grub screws                    | 346      |
| <b>D</b>  |          |                                |          |
| descalers                                       | 359      |                                |          |
| DIN rails                                       | 113      |                                |          |
| door seals                                      | 291      |                                |          |
| door seals for dishwashers                      | 305      |                                |          |
| door seals with fixing hook                     | 294      |                                |          |
| dosing pumps                                    | 319      |                                |          |
| double nipples                                  | 329      |                                |          |
| double wire clamps                              | 337, 356 |                                |          |

Зип Общепит

vsezip.ru

+7(812)987-08-81

|  |          |                                  |          |
|--|----------|----------------------------------|----------|
| <b>H</b>                               |          | mechanical timers                | 44       |
| halogen lamp                           | 38       | microswitches                    | 28       |
| handle latches                         | 254      | miscellaneous                    | 108      |
| heating cables                         | 7        | motors                           | 97       |
| heating elements                       | 3, 7     | mounting spigots                 | 354      |
| heating elements for convection        | 13       | <b>N</b>                         |          |
| heating elements for defrosting        | 6        | Niplaflex hoses                  | 324      |
| heating elements for fryers            | 3        | nuts                             | 347      |
| heating elements for griddles          | 6        | <b>O</b>                         |          |
| heating elements for heated trolleys   | 7        | operating capacitors             | 105      |
| heating elements for ovens             | 3        | O-rings                          | 295      |
| heating elements for pasta cookers     | 7        | oval head screws                 | 343      |
| heating elements for refrigeration     | 6        | oven hinges                      | 260      |
| heating elements for tilting bratt pan | 7        | oven lamps                       | 39       |
| heating plates                         | 8        | <b>P</b>                         |          |
| hexagonal nuts                         | 348      | piezoelectric igniters           | 140      |
| hexagonal screws                       | 343      | pilot burners                    | 130      |
| hob burners                            | 143      | plate nuts                       | 347      |
| hose clamps                            | 336, 354 | plug-in gaskets                  | 285      |
| hose connectors                        | 329, 330 | plunger sockets                  | 25       |
| hose couplings                         | 322      | pre-rinse hoses                  | 323      |
| hose reels                             | 319      | pressure control hoses           | 324      |
| hoses                                  | 322      | pressure hoses                   | 328      |
| hot air fans                           | 95       | pressure reduction valves        | 336, 336 |
| hot air motors                         | 89       | pressure switches                | 77, 173  |
| hot plates                             | 16       | probe clips                      | 24       |
| <b>I</b>                               |          | probes                           | 55       |
| ignition boxes                         | 129      | programme timers                 | 41       |
| ignition bridges                       | 143      | protection hoses                 | 108      |
| ignition cables                        | 140      | pumps                            | 98       |
| ignition units                         | 141      | pumps for ice machines           | 104      |
| immersion heating elements             | 9        | push/momentary push switches     | 27       |
| indicator lights                       | 36       | PVC supply hoses                 | 322      |
| indicator lights (complete)            | 36       | <b>R</b>                         |          |
| industrial hoses                       | 324      | radial fans                      | 95       |
| inlet spouts                           | 334      | refrigeration cycle components   | 307      |
| inlet taps                             | 334      | refrigeration fans               | 87       |
| <b>K</b>                               |          | refrigeration gaskets            | 285      |
| knurled nuts                           | 348      | refrigeration motors universal   | 87       |
| knurled screws                         | 347      | refrigeration pipes              | 308      |
| <b>L</b>                               |          | refrigeration thermostats        | 24       |
| lamp accessories                       | 41       | relays                           | 49       |
| lamps                                  | 36       | retaining rings                  | 357      |
| light bulbs                            | 38       | ribbon cables                    | 109      |
| linear lamps                           | 38       | rivets/rivet nuts                | 339      |
| <b>M</b>                               |          | rocker/momentary rocker switches | 25       |
| magnetic switches                      | 33       | roll pins                        | 357      |
| measuring equipment                    | 339      | rotary switches                  | 33       |
|  |          | round burners                    | 157      |

Зип Общепит

V

vsezip.ru

+7(812)987-08-81

|                                 |          |                        |     |
|---------------------------------|----------|------------------------|-----|
| <b>S</b>                        |          |                        |     |
| safety bi-metal thermostats     | 17       | valves and tank inlets | 331 |
| safety thermostats              | 20       | vibration pumps        | 104 |
| Schrader valves                 | 307      |                        |     |
| screw fixings                   | 359      |                        |     |
| screw locks                     | 360      | wash and rinse pumps   | 98  |
| screw-in gaskets                | 289      | washers                | 352 |
| screws                          | 341      | water cycle components | 336 |
| sealants and adhesives          | 358      | window seals           | 290 |
| sealing discs                   | 305      |                        |     |
| sealing washers                 | 299      |                        |     |
| shaft gaskets                   | 303      |                        |     |
| sheet metal screws              | 341      |                        |     |
| shelves and shelf rails         | 279      |                        |     |
| shut-off valves                 | 331      |                        |     |
| side bolts                      | 346      |                        |     |
| silicone                        | 336, 358 |                        |     |
| silicone hoses                  | 324      |                        |     |
| slot nuts                       | 354      |                        |     |
| solenoid valves                 | 72       |                        |     |
| solid state relays              | 49       |                        |     |
| spray guns                      | 317      |                        |     |
| spray guns with external thread | 317      |                        |     |
| spring assisted hinges          | 258      |                        |     |
| spring rings                    | 351      |                        |     |
| spring washers                  | 352      |                        |     |
| stainless steel flexi hoses     | 323      |                        |     |
| standpipes                      | 335      |                        |     |
| starting capacitors             | 105      |                        |     |
| supply hoses                    | 322      |                        |     |
| switches and momentary switches | 25       |                        |     |
| system switches (ROLD)          | 30       |                        |     |
| <b>T</b>                        |          |                        |     |
| tank inlets                     | 322      |                        |     |
| temperature probes              | 55       |                        |     |
| terminals                       | 110      |                        |     |
| terminals and connectors        | 110      |                        |     |
| thermocouples                   | 141      |                        |     |
| thermostat gaskets              | 307      |                        |     |
| thermostats                     | 17       |                        |     |
| threaded cable glands           | 109      |                        |     |
| time relays                     | 51       |                        |     |
| timers                          | 41       |                        |     |
| tools                           | 339      |                        |     |
| tooth lock washers              | 353      |                        |     |
| transformers                    | 51       |                        |     |
| tube burners                    | 157      |                        |     |
| <b>U</b>                        |          |                        |     |
| universal probes                | 55       |                        |     |