

3ип Общежит
RICAMBI - SPARE PARTS - PIECES DETACHEES
vsezip.ru

LAVASTOVIGLIE A CAPOT +7(812)987-08-81

PASS THROUGH DISHWASHERS

LAVE VAISSELLES A CAPOT

VALIDO DA MATRICOLA NUMERO

VALID FROM SERIAL NUMBER

VALIDE A PARTIR DU NUMERO DE MATRICULE

205109066



LAVASTOVIGLIE - DISHWASHERS - LAVE VAISSELLE - GESCHIRRSPUELER - LAVAPLATOS

Зип Общепит

Note - Remarks - Remarques

vsezip.ru

+7(812)987-08-81

Зип-Общепит

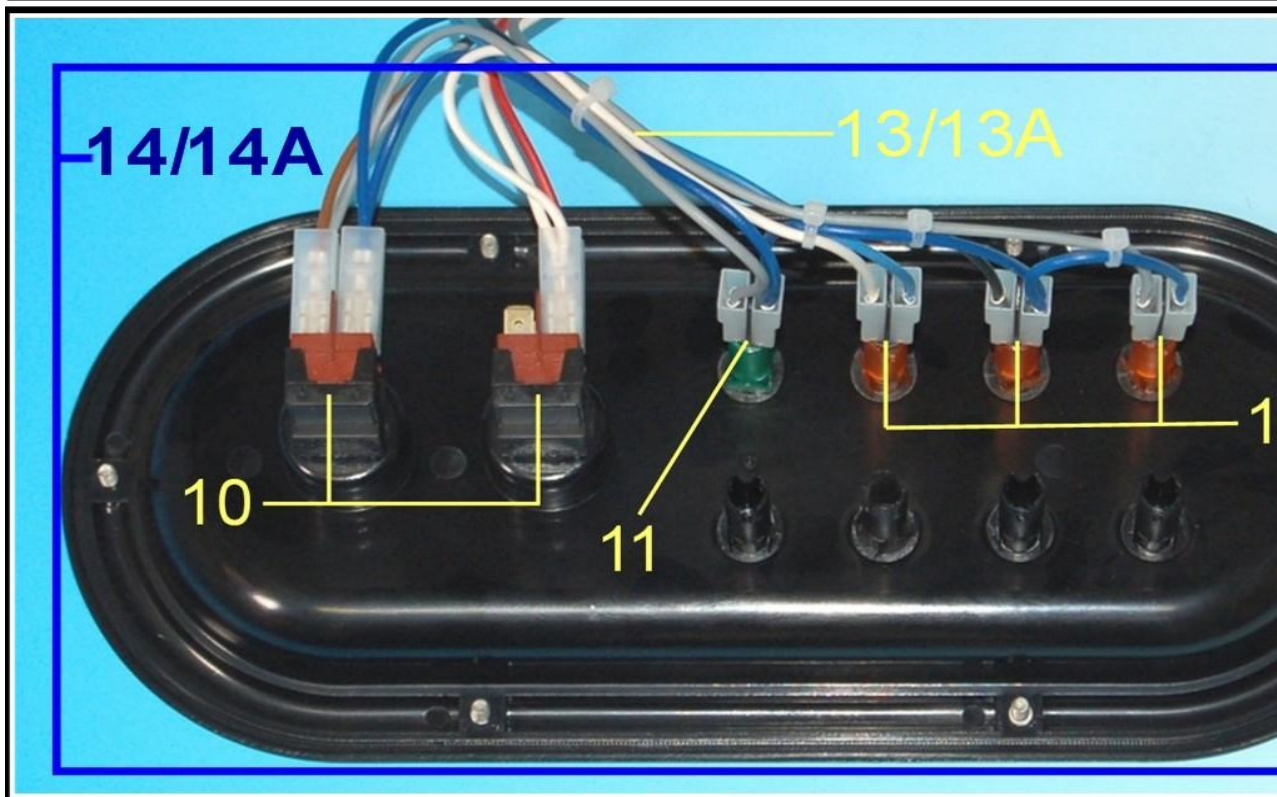

Pos.	Codice	Descrizione	Description	De
1	CEPC6214P105	Pannello comandi Abs nero	Control panel, Abs, plastic, black	Panneau de controle,
2	CETSTR01	Tasto tondo rosso "0-1"	"Cycle selection" button, round, red	Bouton rond rouge
3	CETSTGCL	Tasto tondo grigio "lento/veloce"	Button, round, grey "slow/speed"	Bouton rond gris "l
4	CEGA2328	Gemma nera tonda "0-1"	"0-1" lens, round, black	Voyant "0-1", rond
5	CEGV2329	Gemma nera tonda "ciclo"	"Cycle" lens , round, black	Voyant "cycle", ron
6	CEGV2320	Gemma nera tonda "resistenza boiler"	"Boiler element" lens, round, black	Voyant "resistance surc
7	CEGV2307	Gemma nera tonda "resistenza vasca"	"Tank element" lens, round, black	Voyant "resistance
8	CESPE31	Gemma verde diam. 14mm	Lens, green , diam.14 mm	Voyant vert, diam.
9	CESPE32	Gemma arancio, diam.14mm	Lens, orange, diam.14 mm	Voyant orange, dia
10	CEDP62PS	Deviatore bipolare	Inner switch body	Deviateur bipolaire
11	CESP27V	Lampada a siluro verde 220V	Warning light. green. 220V	Ampoule voyant

Зип ОбщеПИТ

vsezip.ru

+7(812)987-08-81

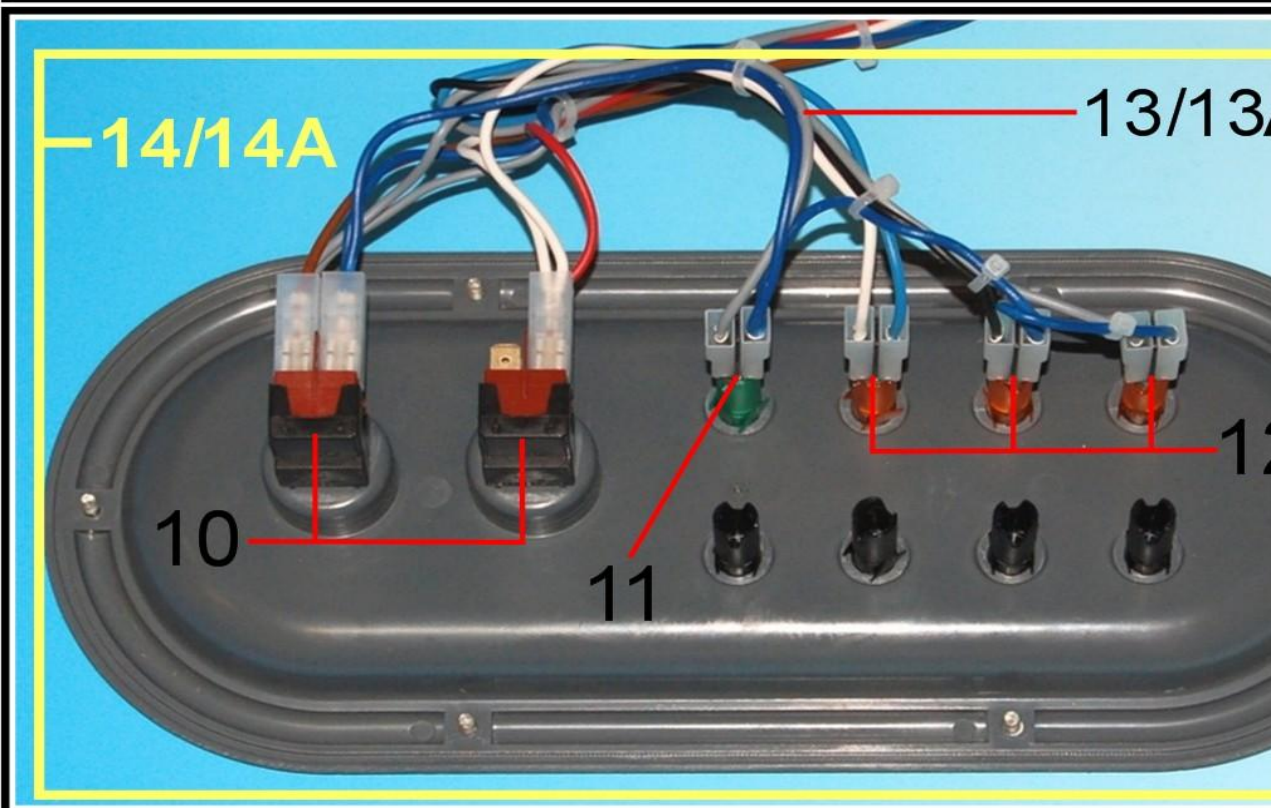

Pos.	Codice	Descrizione	Description	De
1	CEPC6214S05	Pannello comandi grigio	Control panel, ABS, plastic, grey	Panneau de contro
2	CETSTR01	Tasto tondo rosso "0-1"	Cycle selection button, round, red	Bouton rond rouge
3	CETSTBCL	Tasto tondo blu "lento/veloce"	Button, round, blue "slow/fast"	Bouton rond blue "
4	CEGA2328	Gemma nera tonda " 0-1"	"0-1" lens, round, black	Voyant "0-1", rond,
5	CEGV2329	Gemma nera tonda "ciclo"	"Cycle" lens , round, black	Voyant "cycle", ron
6	CEGV2320	Gemma nera tonda "resistenza boiler"	"Boiler element" lens, round, black	Voyant "resistance surc
7	CEGV2307	Gemma nera tonda "resistenza vasca"	"Tank element" lens, round, black	Voyant "resistance
8	CESPE31	Gemma verde diam. 14mm	Lens, green , diam.14 mm	Voyant vert, diam.
9	CESPE32	Gemma arancio, diam.14mm	Lens, orange, diam.14 mm	Voyant orange, dia
10	CEDP62PS	Deviatore bipolare	Inner switch body	Deviateur bipolaire

Зип Общепит

vsezip.ru

+7(812)98708-81

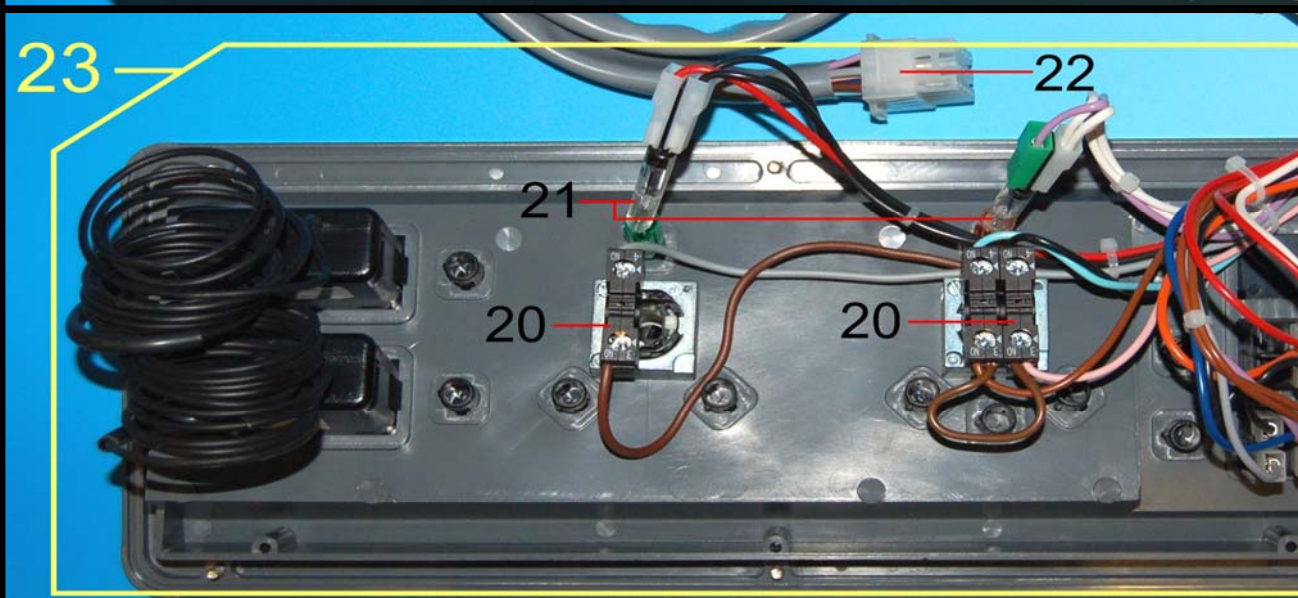

Pos.	Codice	Descrizione	Description	De
1	CEPC621405	Pannello comandi grigio, ABS	Control panel, ABS, grey	Panneau de contro
2	CETEM	Termometro rettangolare	Thermometer, rectangular display	Thermometre recta
3	CESB6194	Tappo simbolo "boiler"	"Boiler" symbol	Symbole "surchauf
4	CESB6204	Tappo simbolo "vasca"	"Tank" symbol	Symbole "cuve"
5	CESB6184	Tappo simbolo "0"	"0" symbol	Symbole "0"
6	CESB6264	Tappo simbolo "1"	"1" symbol	Symbole "1"
7	CEIN623A4NT	Selettore "0-1"	Selector switch, "0-1"	Bouton de selecteu
8	CESP6224	Gemma verde	"On/off" warning light, green	Voyant "On/off", ve
9	CESB6304	Tappo simbolo "ciclo corto"	"Short cycle" symbol	Symbole "cycle bre
10	CESB6314	Tappo simbolo "ciclo lungo"	"Long cycle" symbol	Symbole "cycle lon
11	CESB6324	Tappo simbolo "ciclo medio"	"Medium cycle" symbol	Symbole "cycle mo
12	CESC6284NT	Selettore "1-2-3"	Selector switch, "1-2-3"	Bouton de selector
13	CESP6274	Gemma arancio	Cycle warning light, orange	Voyant "cycle", ora
14	CESB6354	Tappo simbolo "lavaggio manuale"	"Manual wash" symbol	Symbole "lavage m
15	CEDV6364	Deviatore verde	Washing switch, green	Interrupteur lavage
16	CEPU6374	Pulsante arancio	Rinse push button, orange	Bouton "rinçage", c
17	CESB6344	Tappo simbolo "risciacquo manuale"	"Manual rinse" symbol	Symbole "rinçage r
18	CESB6334	Tappo piccolo	Blanking plug, small	Bouchon petit
19	CESB6384	Tappo grande	Blanking plug, large	Bouchon grand

Зип Общепит

vsezip.ru

+7(812)987-08-81

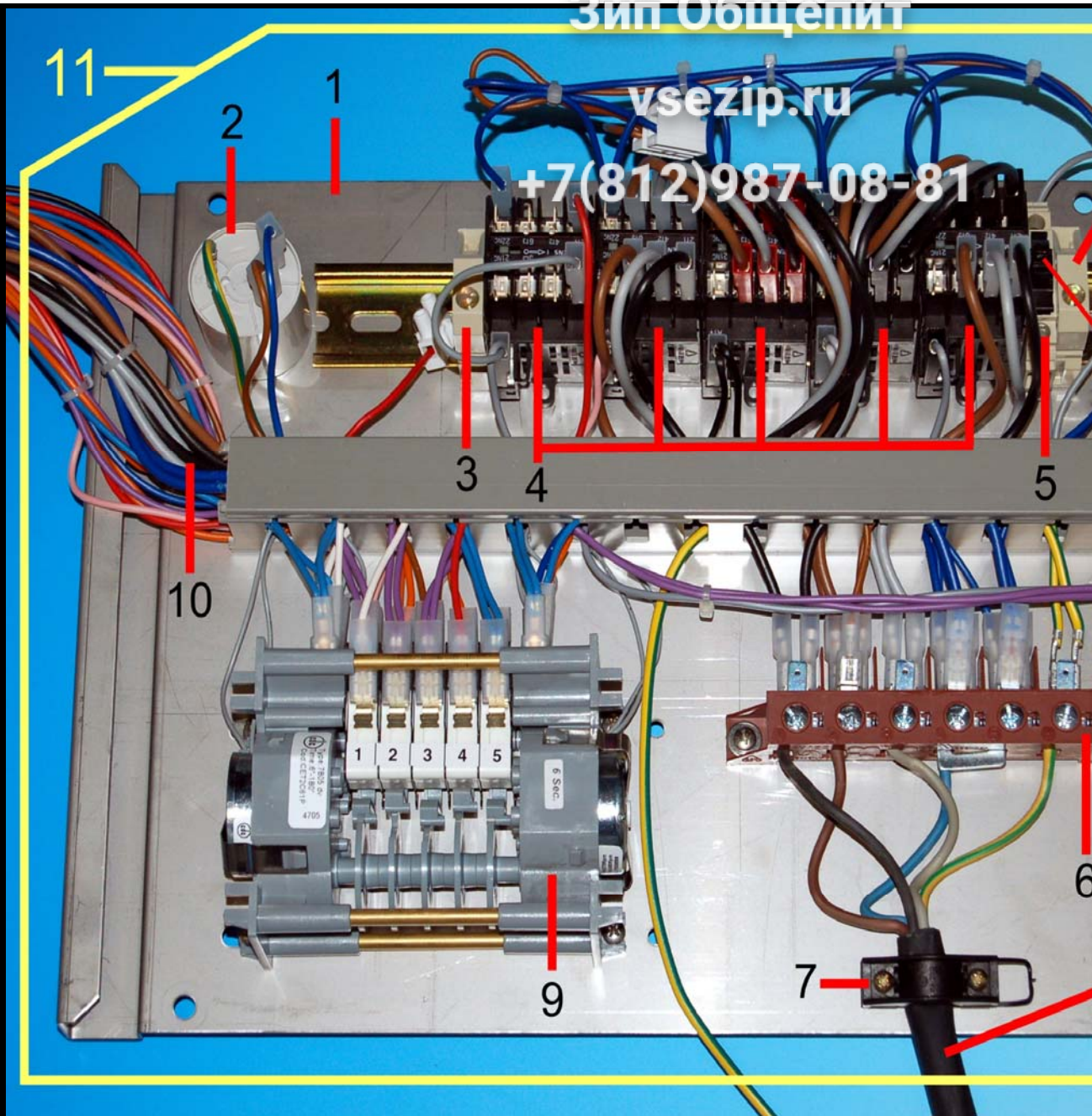

Pos.	Codice	Descrizione	Description	De
1	CEPCE6S05	Piastra cablaggio elettrico	Component tray, no components	Plaque composants
2	CEFA	Filtro antidisturbo	Suppressor	Filtre électrique
3	CEBC6175	Morsetto terminale	Terminal box	Bornier
4	CECTF	Contattore 220V	Contacteur 220V	Contacteur 220V
5	CEMFSTR	Morsetto con portafusibile	Fuse holder block	Borne porte-fusible
5A	CEFU52063A	Fusibile vetro rapido 6,3 A	Fuse 6,3A	Fusible 6,3A
6	CEM0S3F	Morsettiera fv 122/850 trifase	6-way terminal block	Bornier 122/850 3p
7	CEFI6	Fissacavo interno con viti	Supply cable securing block	Arret de cable inter
8	CECE353F	Cavo alimentazione trifase	Electric supply cable, 3ph	Cable d'alimentatio
9	CET2C61P	Timer 2 tempi 90-180" 230v 50hz	Cycle timer , 90-180 secs, 230V 50hz	Timer, 2 temps 90-
10	CECBPI6S	Cablaggio piastra inox	Component panel sub-loom	Cablage panneau c
11	CEPCE61P05C	Piastra inox componenti	Component tray complete assy	Plaque composants

Зип Общепит

vsezip.ru

+7(812)987-08-81

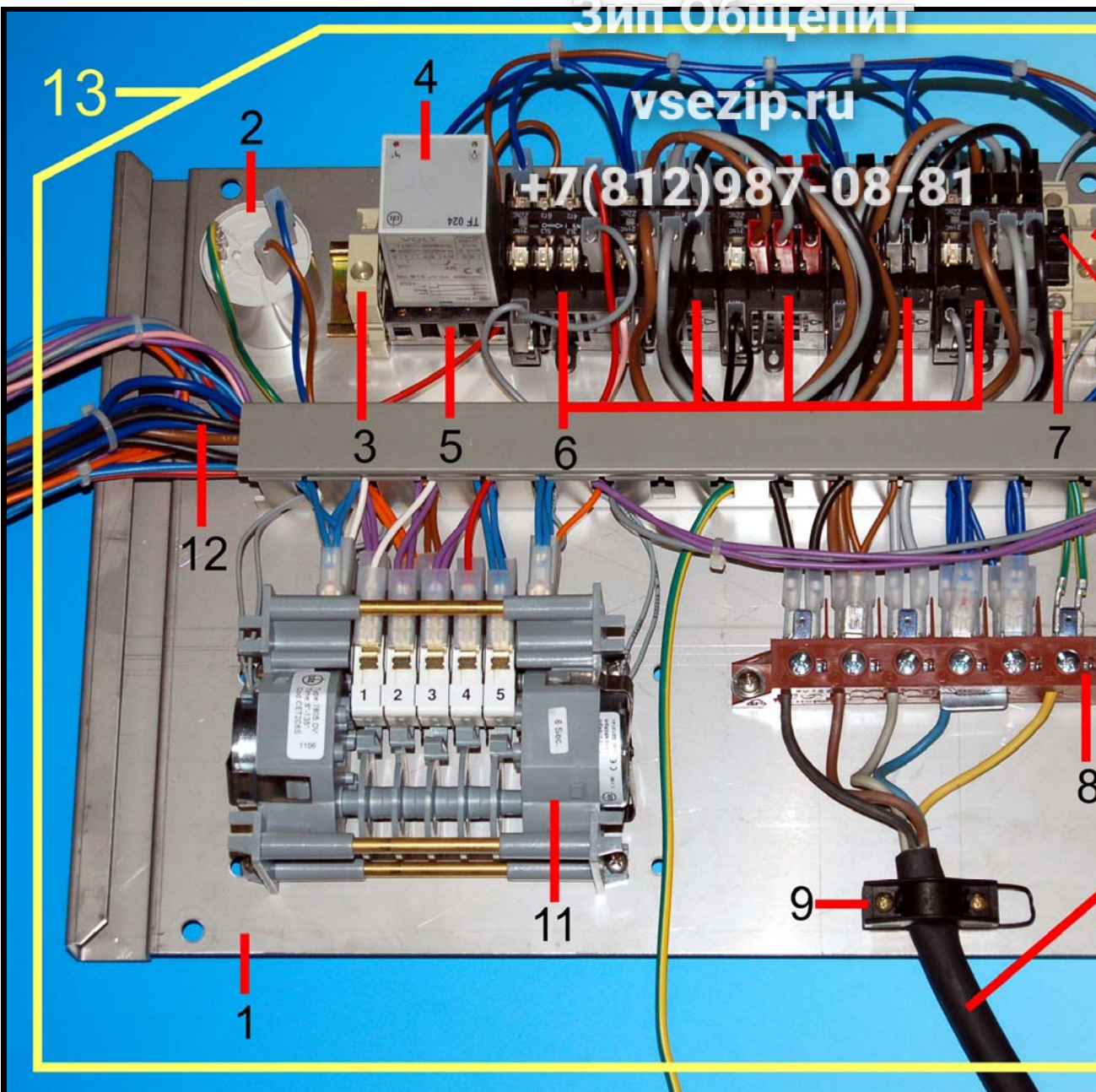

Pos.	Codice	Descrizione	Description	De
1	CEPCE6S05	Piastra cablaggio elettrico capot inox	Component tray, no components	Plaque composants
2	CEFA	Filtro antidisturbo	Suppressor	Filtre électrique
3	CEBC6175	Morsetto terminale	Main terminal block	Bornier
4	CETF604SA	Ritardatore 2a pompa 220V 50HZ	Delay timer, 2nd pump, 220V, 50HZ	Temporisateur 2me
5	CETF60A	Zoccolo octal a vite ritardatore	Base for delay timer	Socle temporisateu
6	CECTF	Contattore 220V	Contacteur 220V	Contacteur 220V
7	CEMFSTR	Morsetto con portafusibile	Fuse holder block	Borne porte-fusible
7A	CEFU52063A	Fusibile vetro rapido 6,3A,dim.5X20mm	Fuse 6,3A, dim 5x20mm	Fusible 6,3A, dim 5
8	CEM0S3F	Morsettiera trifase	6-way terminal block	Bornier, 122/850 3p
9	CEFI6	Fissacavo interno con viti	Supply cable securing block	Arret de cable inter
10	CECE353F	Cavo alimentazione trifase	Electric supply cable 3ph	Cable d'alimentatio
11	CET2C6S	Timer 2 tempi 60-120" 230v 50hz	Cycle timer, 60/120 secs. , 230V-50hz	Timer 2 temp, 60/1
12	CECBPI6S	Cablaggio piastra inox capot	Component panel sub-loom	Cable de connexion
13	CEPCE62S05C	Piastra inox completa assemblata	Component tray complete assv	Plaque composants

Зип Общепит

vsezip.ru

+7(812)987-08-81

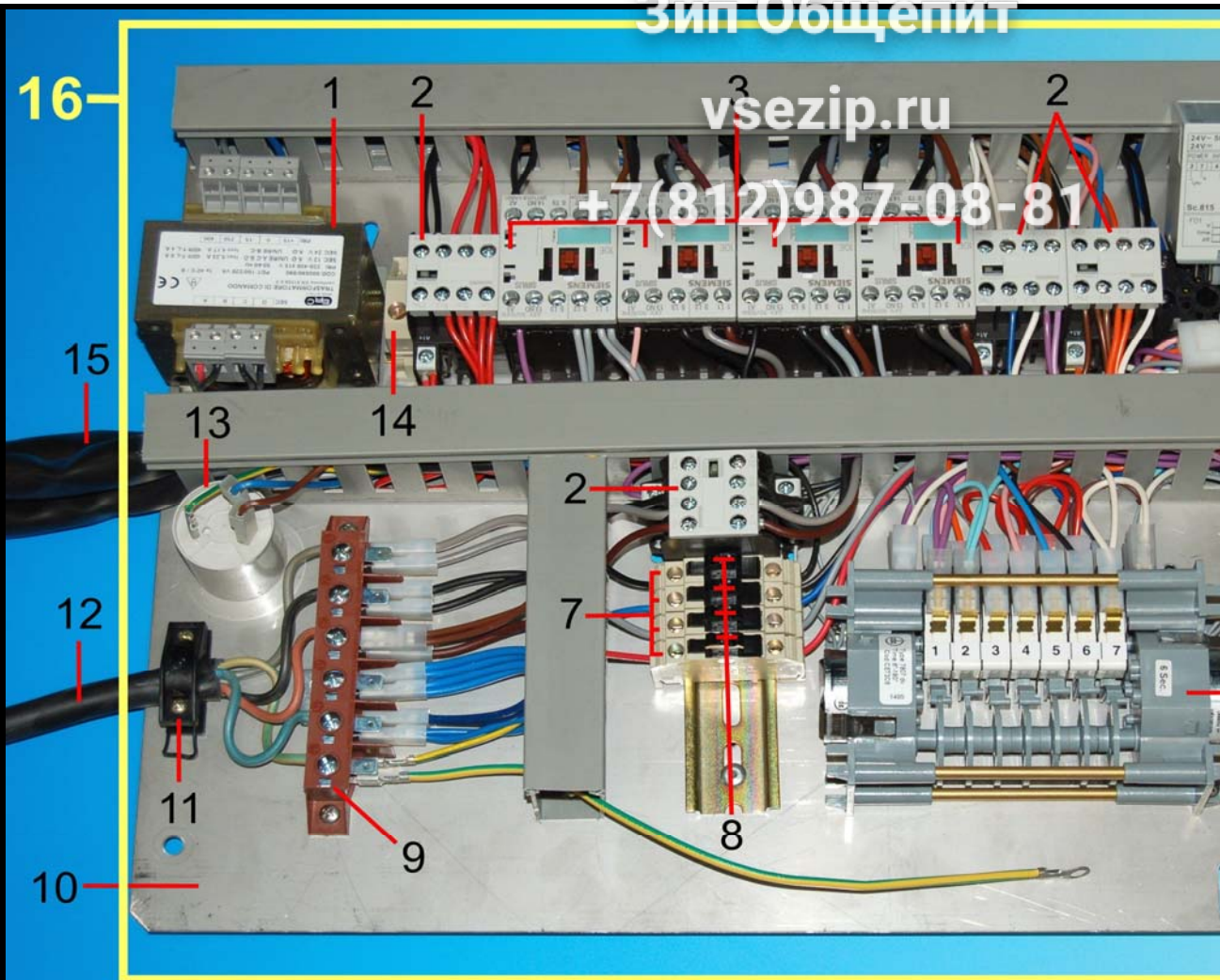

Pos.	Codice	Descrizione	Description	De
1	CETRS24E	Trasformatore	Transformer, 24V	Trasformatore, 24V
2	CECT24P	Teleruttore 3TG 24 volt	Contacteur , for transformer 24V	Contacteur général
3	CECT24G	Teleruttore 3RT 24 volt	Boiler element contactor, 24 V	Contacteur surcha
4	CETF60	Ritardatore 24 volt	Delay timer, 24V	Temporisaterur , 24
5	CETF60A	Zoccolo ritardatore	Base for delay timer	Socle temporisater
6	CET3C6	Timer 24 volt	Cycle timer,60/120/180 sec. 230v-50Hz	Temporisateur, 230
7	CEMFSTR	Portafusibile	Fuse holder block	Borne porte-fusible
8	CEFU52063A	Fusibile 6,3A	Fuse 6,3A	Fusibile 6,3A
9	CEM0S3F	Morsetti trifase	Main terminal block, 6-way	Bornier 3 ph
10	CEPCE605	Piastra inox	Component tray , steel	Plaque composant
11	CEFI6	Fissacavo	Supply cable securing block	Fixage cable
12	CECE353F	Cavo alimentazione trifase	Electric supply cable - 3ph	Cable d'alimentatio
13	CEFA	Filtro antidisturbo	Suppressor	Filtre électrique
14	CEBC6175	Morsetto terminale	Terminal block, 6-way	Bornier terminal
15	CECBPI62P05AS	Cablaggio piastra inox	Control panel wiring loom	Cablage panneau c
16	CEPCE62P05C	Piastra inox completa assemblata	Component tray, complete	Plaque composant

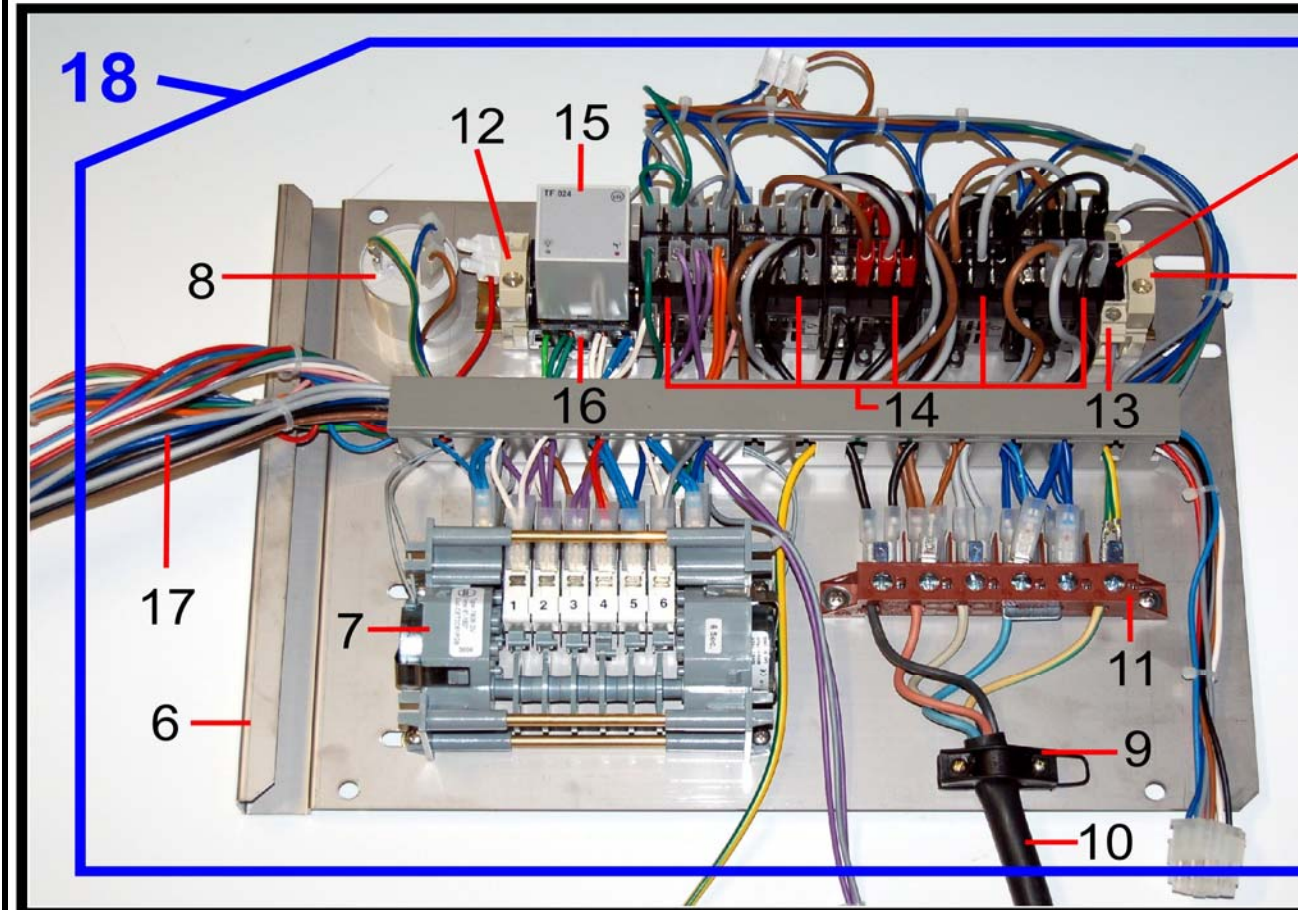
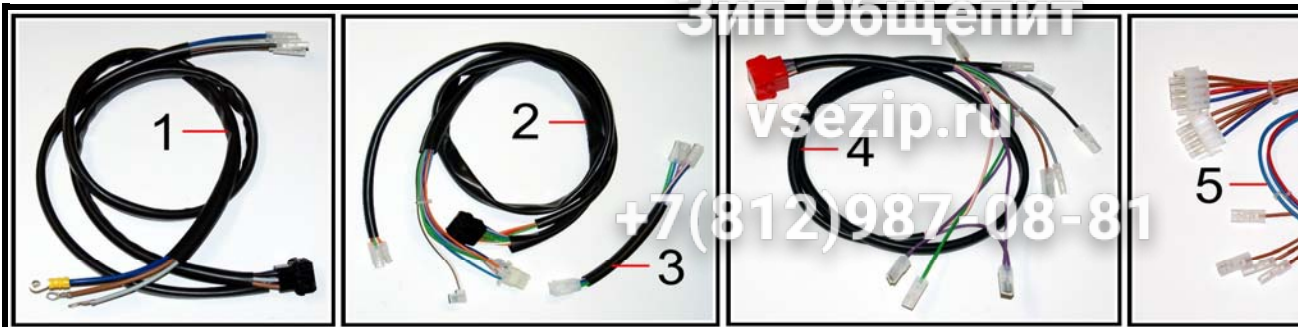

Pos.	Codice	Descrizione	Description	Des
1	CECBPVB61PS05	Cablaggio resistenza vasca, boiler	Element tank wiring loom, boiler	Cablage résistance
2	CECBPM61PS05AB	Cablaggio pressostato air break	ABS pressure switch wiring loom	Cablage pressostat
3	CECBM61PS05AB	Cablaggio micro air break	Micro ABS wiring loom	Cablage micro ABS
4	CECBTPE61PS05AB	Cablaggio termostati air break	ABS thermostat wiring loom	Cablage thermosta
5	CECBPE61PS05AB	Cablaggio pompe, elettrovalvola air break	Pumps wiring loom	Cablage pompes
6	CEPCE6S05	Piastra cablaggio elettrico capot inox	Component tray, no components	Plaque composants
7	CET2C61PGB	Timer 2 tempi 90-180" con interblocco	Cycle timer 90-120" , Interlock version	Timer 90"-180"
8	CEFA	Filtro antidisturbo	Suppressor	Filtre
9	CEFI6	Fissacavo interno con viti	Supply cable securing block	Arret de cable inter
10	CECE353F	Cavo alimentazione trifase	Electric supply cable - 3ph	Cable d'alimentatio
11	CEM0S3F	Morsettiera trifase	Main terminal block, 122/850 3ph	Bornier, 122/850 3p
12	CEBC6175	Morsetto terminale	Main terminal block, Interlock version	Bornier
13	CEMFSTR	Morsetto con portafusibile	Fuse holder	Borne porte-fusible
13A	CEFU52063A	Fusibile vetro rapido 6,3A,dim.5X20mm	Quick blow fuse, 6.3A, 5x20	Fusibile 6,3A, dim 5
14	CECTF	Contattore 220V	Contacteur 220V	Contacteur 220V

Зип-Общепит

vsezip.ru

+7(812)987-08-81

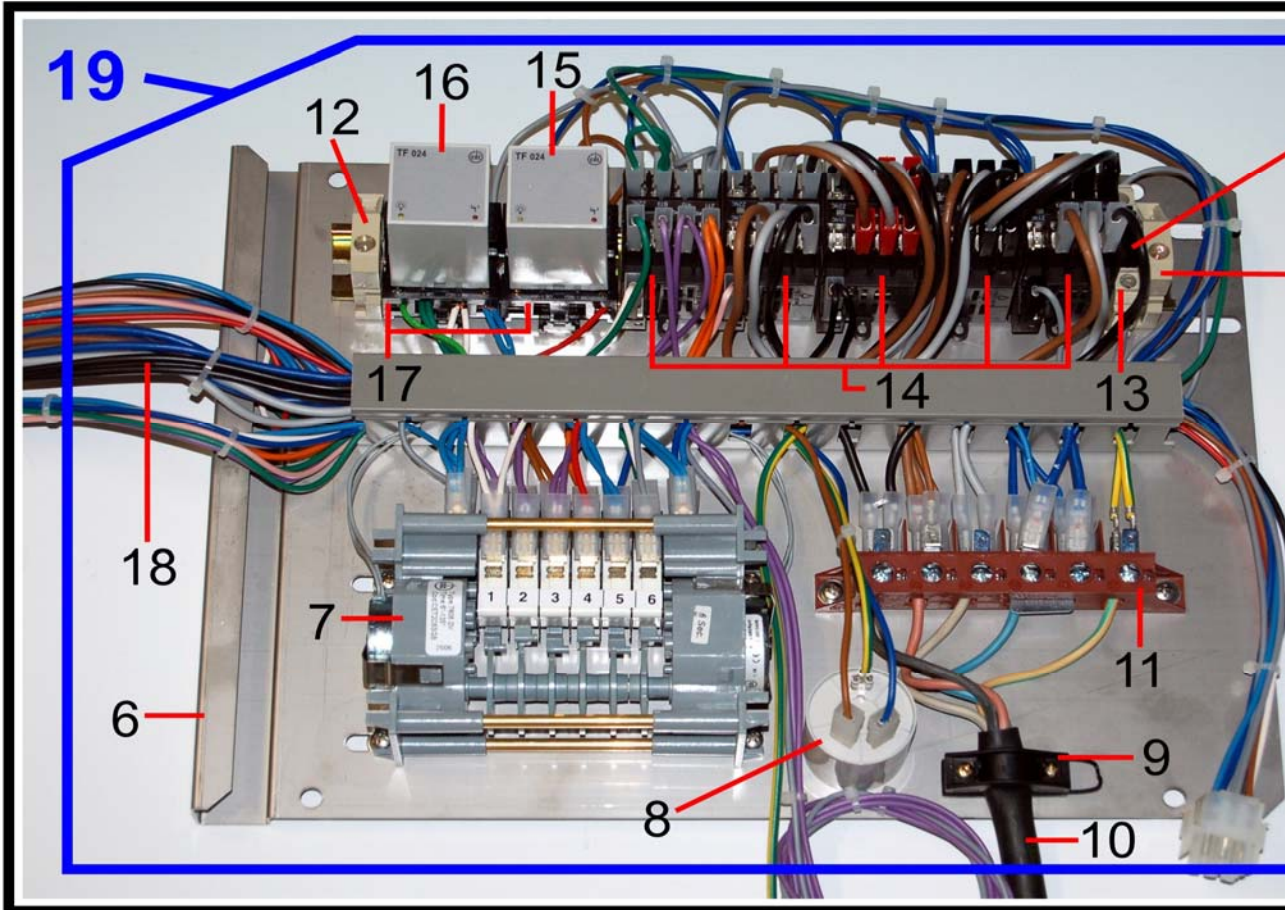
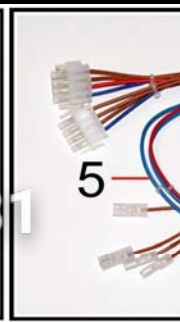
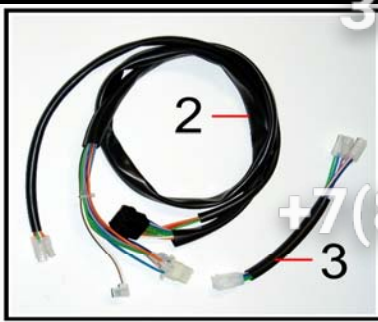

Pos.	Codice	Descrizione	Description	Des
1	CECBPV61PS05	Cablaggio resistenza vasca, boiler	Element tank wiring loom, boiler	Cablage résistance
2	CECBPM61PS05AB	Cablaggio pressostato air break	ABS pressure switch wiring loom	Cablage pressostat
3	CECBM61PS05AB	Cablaggio micro air break	Micro ABS wiring loom	Cablage micro ABS
4	CECBTPE61PS05AB	Cablaggio termostati air break	ABS thermostat wiring loom	Cablage thermosta
5	CECBPE61PS05AB	Cablaggio pompe, elettrovalvola air break	Pumps wiring loom	Cablage pompes
6	CEPCE6S05	Piastra cablaggio elettrico capot inox	Component tray, no components	Plaque composants
7	CET2C6SGB	Timer 2 tempi 60-135" con interblocco	Cycle timer, 60-135", Interlock version	Timer 60-135"
8	CEFA	Filtro antidisturbo	Suppressor	Filtre
9	CEFI6	Fissacavo interno con viti	Supply cable securing block	Arret de cable ente
10	CECE353F	Cavo alimentazione trifase	Electric supply cable - 3ph	Cable d'alimentatio
11	CEM0S3F	Morsettiera trifase	6-way terminal block	Bornier, 122/850 3p
12	CEBC6175	Morsetto terminale	6-way terminal block	Bornier
13	CEMFSTR	Morsetto con portafusibile	Fuse holder block	Borne porte-fusible
13A	CEFU52063A	Fusibile vetro rapido 6,3A,dim.5X20mm	Quick blow fuse, 6,3A, 5x20	Fusibile 6,3A, dim 5
14	CECTF	Contattore 220V	Contacteur 220V	Contacteur 220V

Зип Общепит

vsezip.ru

+7(812)987-08-81

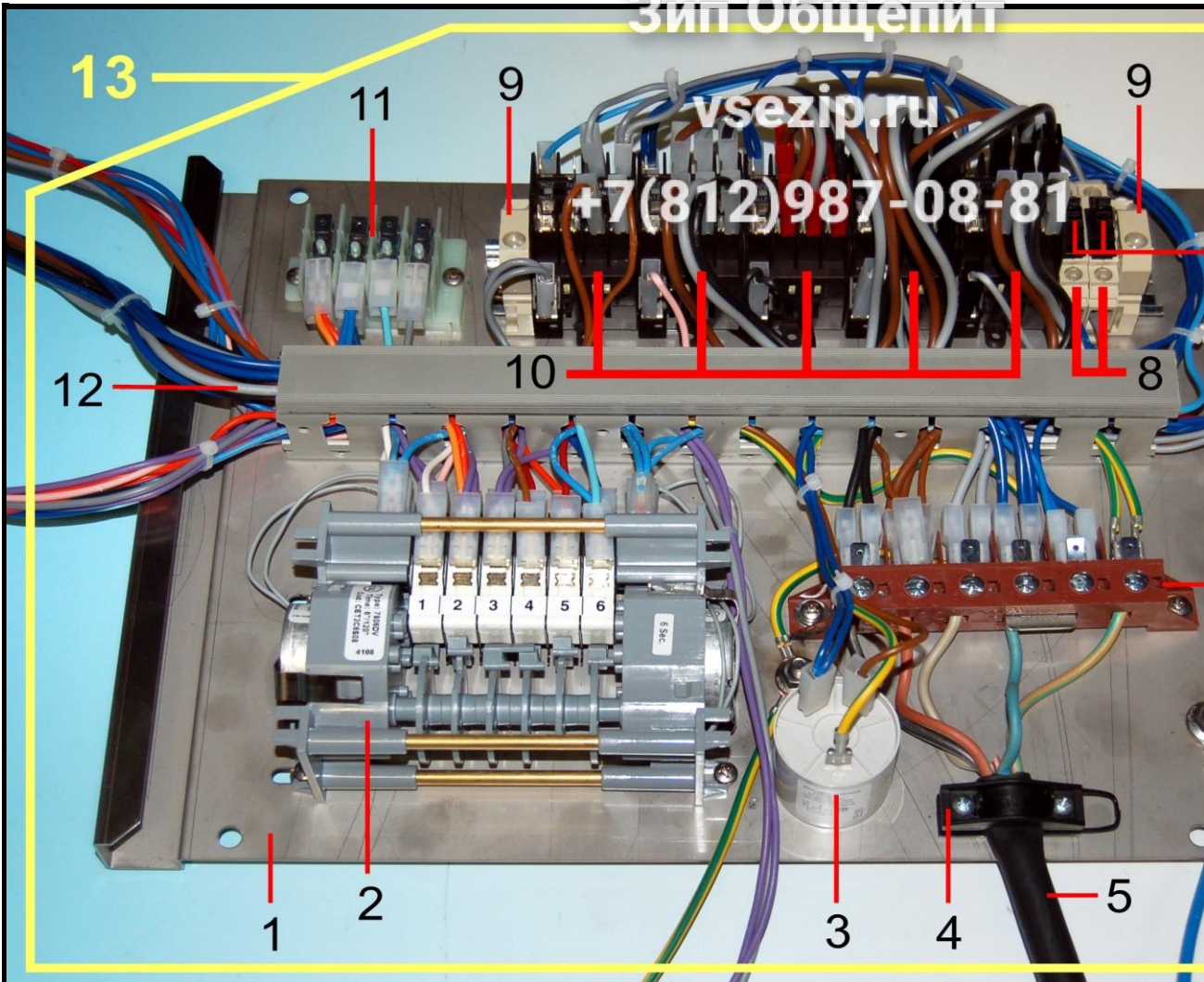

Pos.	Codice	Descrizione	Description	De
1	CEPCE6S09	Piastra cablaggio elettrico capot inox	Component tray, no components	Plaque composant
2	CET2C6S08	Timer 2 tempi 60-120" 230v 50hz	Cycle timer, 60/120 secs. , 230V-50hz	Timer 2 temp, 60/1
3	CEFA	Filtro antidisturbo	Suppressor	Filtre électrique
4	CEFI6	Fissacavo interno con viti	Supply cable securing block	Arret de cable inter
5	CECE353F	Cavo alimentazione trifase	Electric supply cable 3ph	Cable d'alimentatio
6	CETS62P	Tirante sicurezza antisfilamento piastra	Limit cable for component tray movement	Tirant de securite
7	CEM0S3F	Morsettiera trifase	6-way terminal block	Bornier, 122/850 3p
8	CEMFSTR	Morsetto con portafusibile	Fuse holder block	Borne porte-fusible
8A	CEFU52063A	Fusibile vetro rapido 6,3A,dim.5X20mm	Fuse 6,3A, dim 5x20mm	Fusible 6,3A, dim 5
9	CEBC6175	Morsetto terminale	Main terminal block	Bornier
10	CECTF	Contattore 220V	Contacteur 220V	Contacteur 220V
11	CEM0SDDB	Morsettiera 4 poli per dosatori peristaltici	4 Ways terminal block for detergent pumps	Bornier 4 sorties pour
12	CECBPI6S08	Cablaggio piastra inox 62P/S (2008)	Component panel sub-loom	Cable de connexion
13	CEPCE62S08C	Piastra inox completa assemblata	Component tray complete assy	Plaque composant

Зип Общепит

vsezip.ru

+7(812)987-08-81

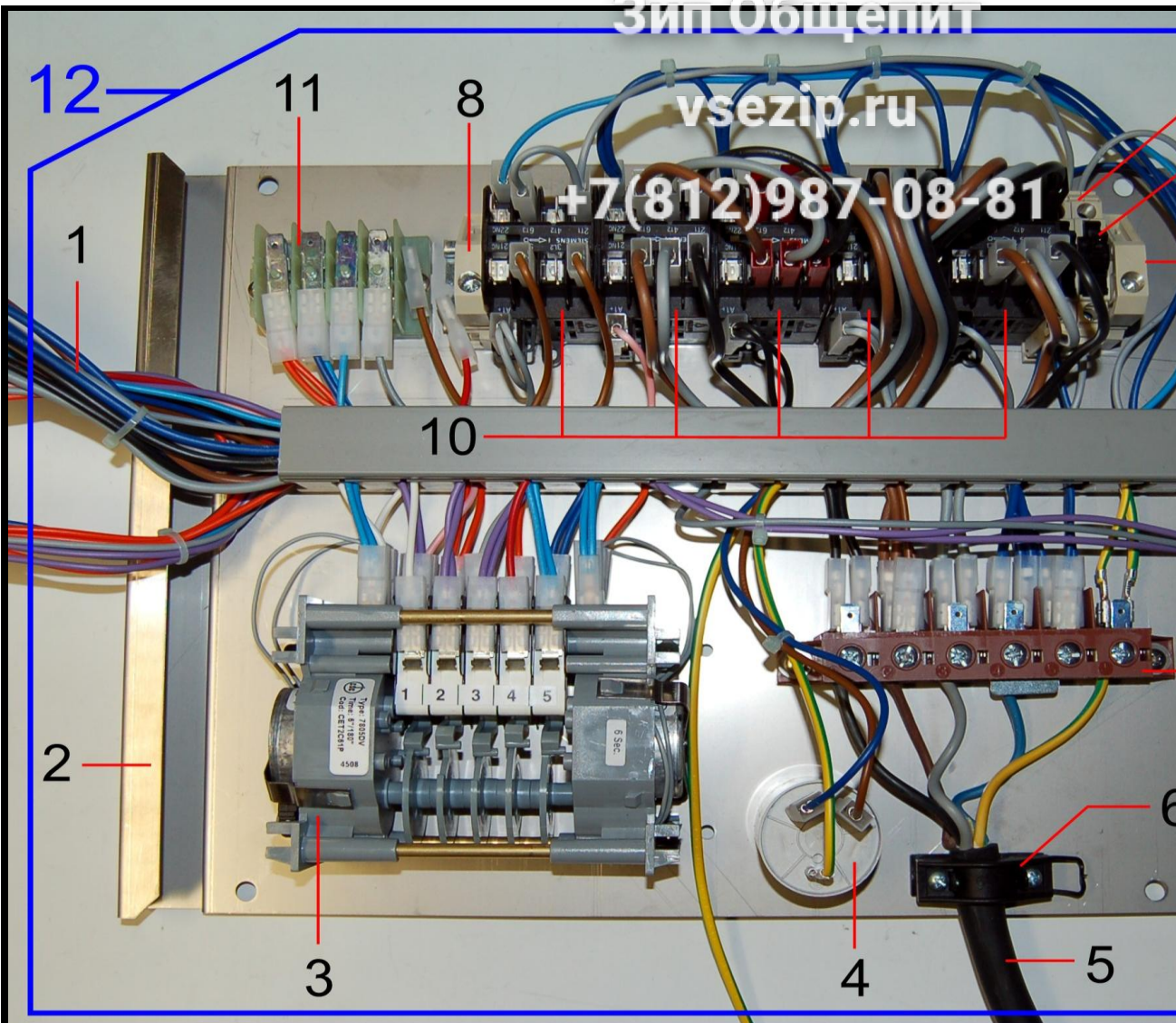

Pos.	Codice	Descrizione	Description	De
1	CECBPI6S08	Cablaggio piastra inox (2008)	Component panel sub-loom	Cable de connexion
2	CEPCE6S09	Piastra cablaggio elettrico capot inox	Component tray, no components	Plaque composant
3	CET2C61P	Timer 2 tempi 90-180° 61P 230V 50hz	Cycle timer, 90/180 secs. , 230V-50hz	Timer 2 temp, 90/1
4	CEFA	Filtro antidisturbo	Suppressor	Filtre électrique
5	CECE353F	Cavo alimentazione trifase	Electric supply cable 3ph	Cable d'alimentatio
6	CEFI6	Fissacavo interno con viti	Supply cable securing block	Arret de cable inter
7	CEM0S3F	Morsetti trifase	6-way terminal block	Bornier, 122/850 3p
8	CEBC6175	Morsetto terminale	Main terminal block	Bornier
9	CEMFSTR	Morsetto con portafusibile	Fuse holder block	Borne porte-fusible
9A	CEFU52063A	Fusibile vetro rapido 6,3A,dim.5X20mm	Fuse 6,3A, dim 5x20mm	Fusible 6,3A, dim 5
10	CECTF	Contattore 220V	Contacteur 220V	Contacteur 220V
11	CEM0SDDB	Morsetti 4 poli per dosatori peristaltici	4 Ways terminal block for detergent pumps	Bornier 4 sorties pour
12	CEPCE61P09C	Piastra inox completa assemblata	Component tray complete assy	Plaque composant

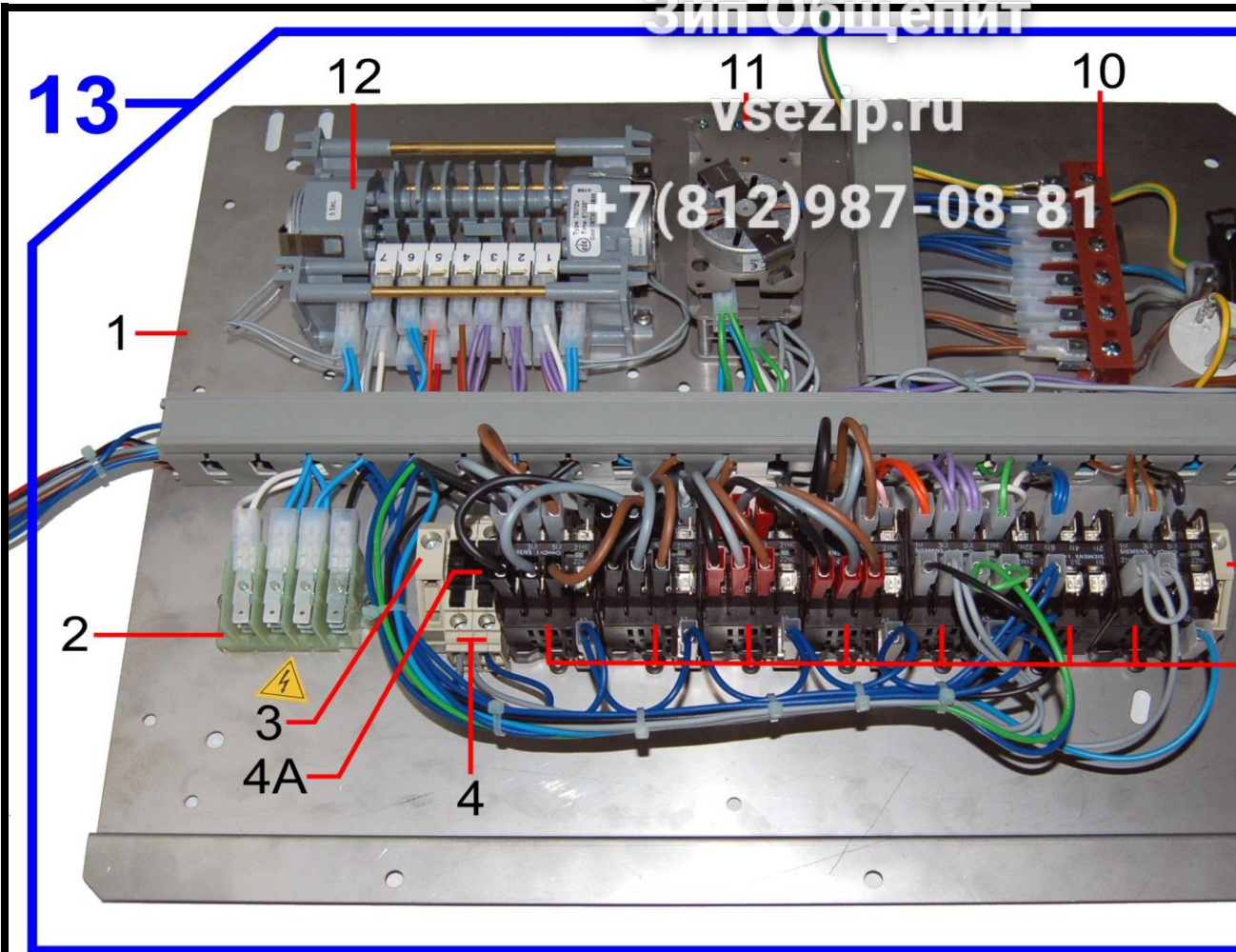

Pos.	Codice	Descrizione	Description	De
1	CEPCE605	Piastra cablaggio elettrico capot inox	Component tray, no components	Plaque composant
2	CEM0SDDDB	Morsettiera 4 poli per dosatori peristaltici	4 Ways terminal block for detergent pumps	Bornier 4 sorties pour
3	CEBC6175	Morsetto terminale	Main terminal block	Bornier
4	CEMFSTR	Morsetto con portafusibile	Fuse holder block	Borne porte-fusible
4A	CEFU52063A	Fusibile vetro rapido 6,3A,dim.5X20mm	Fuse 6,3A, dim 5x20mm	Fusible 6,3A, dim 5
5	CECTF	Contattore 220V	Contactore 220V	Contacteur 220V
6	CECBPI6S08AB	Cablaggio piastra inox capot	Component panel sub-loom	Cable de connexion
7	CEFA	Filtro antidisturbo	Suppressor	Filtre électrique
8	CECE353F	Cavo alimentazione trifase	Electric supply cable 3ph	Cable d'alimentatio
9	CEFI6	Fissacavo interno con viti	Supply cable securing block	Arret de cable inter
10	CEM0S3F	Morsettiera trifase	6-way terminal block	Bornier, 122/850 3p
11	CETF2CPABS	Timer 2 camme pompa risciacquo ABS	Cycle timer, 2-cam for rinse ABS	Timer, 2 cammes p
12	CET2C6SGB08	Timer 2 tempi 60-120" 62P/S (7 CAM) GB	Cycle timer, 60"-120" mod 62P/S, 7 Cam, GB	Timer, 2 temps, 60"-12
13	CEPCE62S08ABC	Piastra inox completa assemblata 62P/S ABS	Component tray complete assy	Plaque composant



Pos.	Codice	Descrizione	Description	Dé
1	GP02562PB	Trappola aria	Pressure vessel	Chambre de comp
2	OR3118	Or 3118	O-ring 3118	Joint 3118
3	D034	Dado 3/4	Brass nut, 3/4	Ecrou 3/4
4	TSIL48	Tubo silicone 4x8 mm	Silicone tube 4X8 mm	Tube silicone 4X8
5	CEPR62P	Pressostato 1 livello 30-90	Air pressure switch	Pressostat 1 nivea
6	AM0SQPR6	Squadretta fissaggio pressostato	Switch mounting bracket	Plaque support p
7	CECBPM62P05	Cablaggio pressostato micro, 24 volt	Mini loom for hood switch, 24 V	Cablage micro, 24V
8	CESMP61SC	Scatola micro completa assemblata	Micro switch assembly, complete	Boite du micro, cor
9	VD6FLI	Dado esagonale m6 flangiato	Flanget nut M6	Ecrou M6
10	CEPAMP6S	Perno azionamento micro, 6x40mm	Push rod, hood switch, 6X4 mm	Axes en inox, 6X4
11	CEMPPIB	Puntale perno azionamento micro	Push rod end cap	Couvercle pour tête
12	CESMP62PS	Scatola micro	Micro switch housing	Boite du micro
13	CECSM62PS	Coperchio scatola micro	Micro switch cover	Couvercle boite mi
14	CETAM62PS	Tasto azionamento micro	Mushroom head for plunger rod	Bouton pour micro
15	CEMMP6S	Molla micro	Stainless steel spring	Ressort inox
16	CEMP22	Seeger micro	Circlip	Circlips
17	CEMP6S	Perno azionamento micro , 6x60 mm	Plunger rod for hood switch, 6X6 mm	Axes en inox, 6X6
18	CEAZM62PS	Azionatore micro	Micro switch actuator block	Micro activateur
19	VDAB3BI	Dado autobloccante m3	Self - locking nut, M3	Ecrou M3
20	VVTCC350I	Vite 3x50mm	Screw 3X5 mm	Vis 3x5 mm



Pos.	Codice	Descrizione	Description	Des
1	LI18F	Perno inox lavaggio corto	Upper spindle	Axes en inox, lavag
2	LS6012B	Supporto mozzo superiore	Top boss	Support superieur
3	G15102F	Guarnizione 3/8" gas	Seal	Joint 3/8"
4	GR6223FLEX	Tubo risciacquo flex	Upper rinse flexible pipe	Tuyau rinçage sup
5	D038A	Dado 3/8"	Brass lock nut 3/8"	Écrou 3/8"
6	G15253G	Guarnizione raccordo dim. 15x25x3	Seal for connection elbow,dim.15x25x3	Joint pour raccord,
7	GR6193	Gomito asta risciacquo superiore	Rinse connection elbow	Raccord rinçage su
8	GR6183	Raccordo "y" 3 vie portagomma	3-way connector, 11mm	Raccord "Y"
9	GB645305	Supporto boiler	Boiler mounting bracket	Support surchauffe
10	GB413FNT05	Boiler trifase	Boiler 3ph	Surchauffeur 3ph
11	AM0SQFB06	Piastrina fissaggio boiler	Bracket	Plaque support bol
12	CERB603F	Resistenza boiler 6000/3W, 230V	Rinse element, 6.0 kW, 3-loop, 230V	Résistance surcha
13	CERB903F	Resistenza boiler 9000/3W, 230V	Rinse element, 9.0 kW, 3-loop, 230V	Résistance surcha
14	ORRB3F	Or resistenza boiler trifase	O ring for rinse element, large	Joint pour resistanc
15	CESB454	Termostato sicurezza boiler	Rinse safety thermal switch	Thermostat securit
16	GB083F	Protezione resistenza boiler trifase	Rinse element guard, large	Protection resistanc
17	GB093F	Nottolino protezione resistenza trifase	Retaining nut, rinse element, large	Ecrou fixation protec
18	CEPRV3F	Protezione resistenza vasca trifase	Wash element guard	Protection resistanc
19	D0114	Dado 1"1/4	Brass nut 1 1/4"	Écrou serrage 1 1/4
20	G50403GT	Guarnizione resistenza vasca trifase	Wash element seal	Joint resistance cu
21	AM0SQPRR6	Squadretta premiresistenza	Element retaining clip	Plaquette
22	TG1117	Tubo gomma 11x17	Standard rinse hose 11x17mm	Tuyau caoutchouc
23	TG1117FDA	Tubo gomma 11x18 blu	Rinse hose FDA spec 11x18mm blue	Tuyau caoutchouc

Зип Общепит

vsezip.ru

+7(812)987-08-81



Pos.	Codice	Descrizione	Description	De
1	GRMP6AB	Manicotto mandata risciacquo air break	Rinse pump outlet hose, ABS	Manchon refouleme
2	TG1117FDA	Tubo gomma 11x18 blu	Rinse hose FDA spec 11x18mm blue	Tuyau caoutchouc
3	ABRTRP	Raccordo "t" pompa risciacquo	Tee connector, ABS	Raccord "t" rinçage
4	TG1118WRC	Tubo diam. 11x18mm "wrc"	Rinse supply hose WCR spec 11x 18	Tuyau 11x18 mm "
5	ABCSB	Coperchio inox interno serbatoio air break	Top cover for ABS tank	Bouchon inox cuve
6	GSDETPI10COMP	Portagomma inox detergente completo	Connection elbow, steel, complete assy	Joint, inox, vidange
7	ABDFIV	Deflettore inox interno vasca air break	Protection plate for ABS wash tank	Deflecteur inox cuv
8	ABDFISB	Deflettore inox interno serbatoio air break	Deflector plate for ABS tank	Deflecteur inox cuv
9	GRS06B	Iniettore sfiato	Inlet elbow	Raccord
10	D038A	Dado 3/8"	Brass lock nut 3/8"	Ecrou 3/8"
11	OR128	Or 128	O ring 128	Joint 128
12	ABDFSB	Dado inox fissaggio serbatoio AB	Nut, steel	Ecrou
13	ABSB46	Serbatoio inox air break	ABS tank, Steel	Cuve inox air break
14	ABMSB6	Manicotto tra serbatoio e boiler air break	ABS tank exit hose	Manchon entre cuve e
15	GAMA6AB	Manicotto aspirazione pompa air break	Rinse pump inlet hose, ABS	Joint aspirateur por
16	ABPRF5213	Pompa aumento pressione	Rinse pump, ABS	Suppresseur
17	ABSTFP5213	Staffa fissaggio pompa air break	Mounting bracket for rinse pump, ABS	Equerre inox
18	GB413FNT05AB	Boiler trifase air break	Boiler, 3-ph, ABS version	Surchauffeur ABS V
19	TSIL48	Tubo silicone 4x8 mm	Silicone tube 4X8 mm	Tube silicone 4X8
20	CEPR62P	Pressostato 1 livello 30-90	Air pressure switch	Pressostat 1 nivea

Зип Общежит

vsezip.ru

+7(812)987-08-81

Dal 01/2007
Starting from
A partir du



Pos.	Codice	Descrizione	Description	De
1	GRMP6AB	Manicotto mandata risciacquo air break	Rinse pump outlet hose, ABS	Manchon refouleme
2	TG1117FDA	Tubo gomma 11x18 blu	Rinse hose FDA spec 11x18mm blue	Tuyau caoutchouc
3	ABRTRP	Raccordo "t" pompa risciacquo	Tee connector, ABS	Raccord "t" rinçage
4	TG1118WRC	Tubo diam. 11x18mm "wrc"	Rinse supply hose WCR spec 11x 18	Tuyau 11x18 mm "
5	ABCSB	Coperchio inox interno serbatoio air break	Top cover for ABS tank	Bouchon inox cuve
6	GSEDETP10COMP	Portagomma inox detergente completo	Connection elbow, steel, complete assy	Joint, inox, vidange
7	ABGCSAB34229	Guarnizione 34x229x3 serbatoio air break	Seal, air break tank	Joint pour cuve ino
8	ABCSAB46	Cornice serbatoio	Door handle, AB, 69 x140	Entourage cuve ino
9	ABDFSB	Dado inox fissaggio serbatoio AB	Nut, steel	Ecrou
10	ABGSB203015	Guarnizione 30x20x1,5 serbatoio air break	Seal, air break tank	Joint pour cuve ino
11	ABSB4607	Serbatoio inox air break (2007)	ABS tank, Steel (2007)	Cuve inox air break
12	OR128	Or 128	O ring 128	Joint 128
13	ABRISAB46	Raccordo interno serbatoio	Tube elbow adptor	Raccord int. cuve
14	ABRESAB46	Raccordo esterno serbatoio	Tube elbow adptor	Raccord est. cuve
15	ABDFIV07	Deflettore inox vasca air break (2007)	Protection plate for ABS wash tank (2007)	Deflecteur inox cuv
16	ABMSB6	Manicotto tra serbatoio e boiler air break	ABS tank exit hose	Manchon entre cuve e
17	GAMA6AB	Manicotto aspirazione pompa air break	Rinse pump inlet hose, ABS	Joint aspirateur por
18	ABPRF5213	Pompa aumento pressione	Rinse pump, ABS	Suppresseur
19	ABSTFP5213	Staffa fissaggio pompa air break	Mounting bracket for rinse pump, ABS	Equerre inox
20	GB413FNT05AB	Boiler trifase air break	Boiler, 3-ph, ABS version	Surchaffeur ABS V
21	TSIL48	Tubo silicone 4x8 mm	Silicone tube 4X8 mm	Tube silicone 4X8
22	CEPR62P	Pressostato 1 livello 30-90	Air pressure switch	Pressostat 1 nivea

Зип Общежит

1 vsezip.ru

+7(812)987-08-81



Pos.	Codice	Descrizione	Description	De
1	LS09PB	Nottolino fissaggio girante	Spindle retaining screw	Ecrou pour pivot
2	LSI46CSB	Asta risciacquo sinistra assemblata	Rinse arm, LH, complete	Rampe rinçage gau
3	LSI46CDB	Asta risciacquo destra assemblata	Rinse arm, RH, complete	Rampe rinçage dro
4	LSI66BSB	Asta lavaggio sinistra assemblata	Wash arm, LH, complete	Rampe lavage gau
5	LSI66BDB	Asta lavaggio destra assemblata	Wash arm, RH, complete	Rampe lavage droi
6	LSI0607AB	Mozzo girante	Centre boss c/w bushes	Moyeu central
7	LSI46CB	Asta risciacquo	Rinse arm only	Rampe rinçage
8	LSI66BB	Asta lavaggio	Wash arm only	Rampe lavage
9	LSI021B	Ghiera fissaggio getto risciacquo	Rinse jet retaining ring	Ecrou fixation gicle
10	LSI022B	Tappo getto risciacquo	Rinse arm blank	Bouchon gicleur rin
11	LSI020B	Getto risciacquo	Rinse jet	Gicleur rinçage
12	LSI017B	Ghiera fissaggio getto lavaggio	Wash jet ring nut	Ecrou gicleur lavag
13	LSI015B	Getto lavaggio destro	Wash jet, RH marked "d"	Ecrou gicleur lavag
14	LSI018B	Tappo getto lavaggio	Wash arm blank	Bouchon

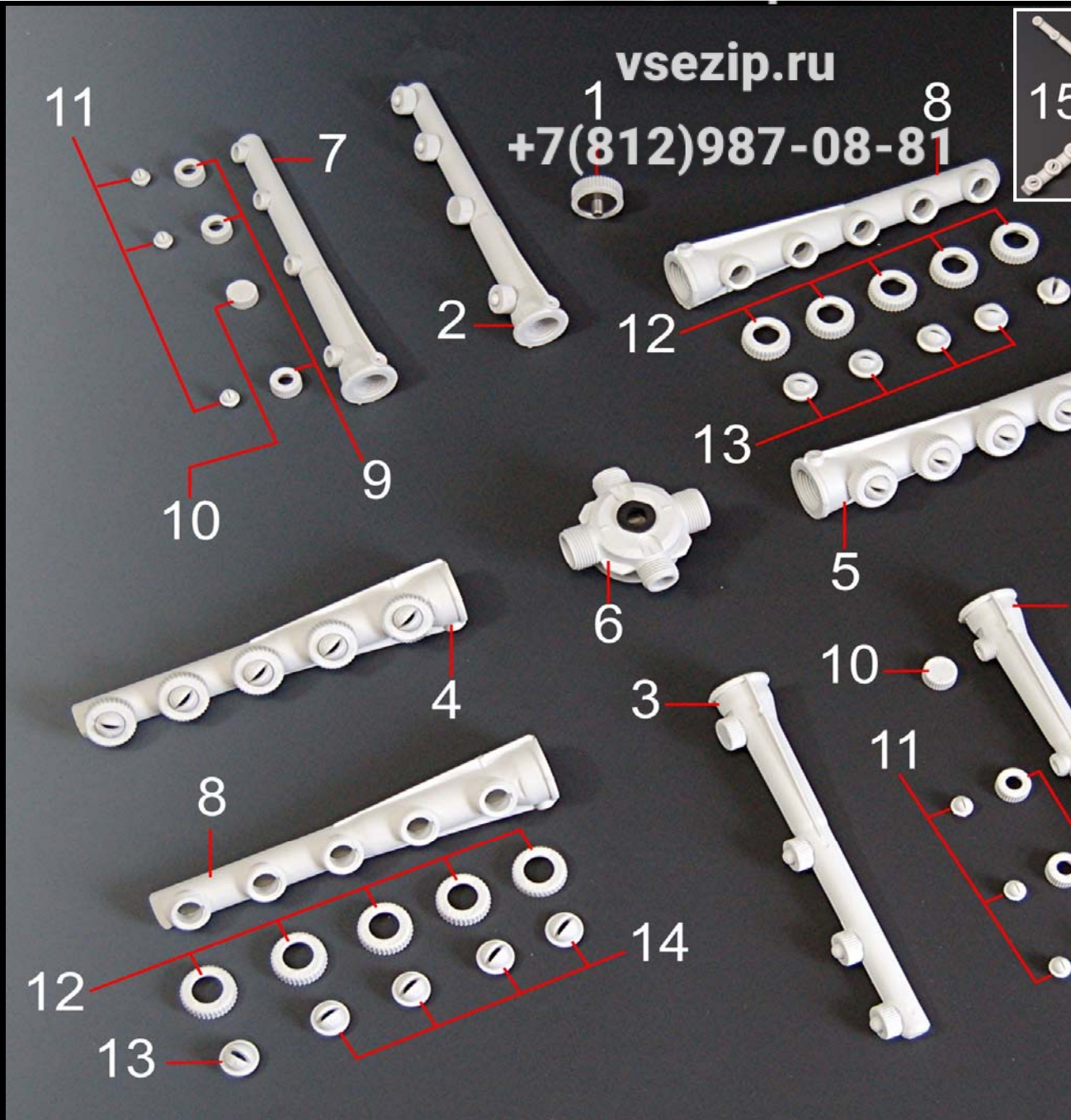

Pos.	Codice	Descrizione	Description	De
1	LS09PB	Nottolino fissaggio girante	Spindle retaining screw	Ecrou pour pivot
2	LSI46CSB	Asta risciacquo sinistra assemblata	Rinse arm, LH, complete	Rampe rinçage gau
3	LSI46CDB	Asta risciacquo destra assemblata	Rinse arm, RH, complete	Rampe rinçage dro
4	LSISA6BSB	Asta lavaggio sinistra assemblata	Wash arm, LH, complete	Rampe lavage gau
5	LSISA6BDB	Asta lavaggio destra assemblata	Wash arm, RH, complete	Rampe lavage droi
6	LSI0607AB	Mozzo girante	Centre boss with bushes	Moyeu central avec
7	LSI46CB	Asta risciacquo	Rinse arm, white	Rampe rinçage
8	LSI66BB	Asta lavaggio	Wash arm, white	Rampe lavage
9	LSI021B	Ghiera fissaggio getto risciacquo	Rinse jet retaining ring	Ecrou gicleur rinça
10	LSI022B	Tappo getto risciacquo	Rinse arm blank	Bouchon gicleur rin
11	LSI020B	Getto risciacquo	Rinse jet	Ecrou gicleur rinç



Pos.	Codice	Descrizione	Description	De
1	LISFL6	Supporto laterale filtri	Filter support, side	Support filtre latéra
2	LISFP6	Supporto posteriore filtro	Filter support, back	Support filtre postè
3	LISFC6	Supporto centrale filtri	Filter support, central	Support filtre centra
4	LISEA6	Supporto anteriore filtro	Filter support, front	Support filtre antèri

Зип Общепит

vsezip.ru

+7(812)987-08-81

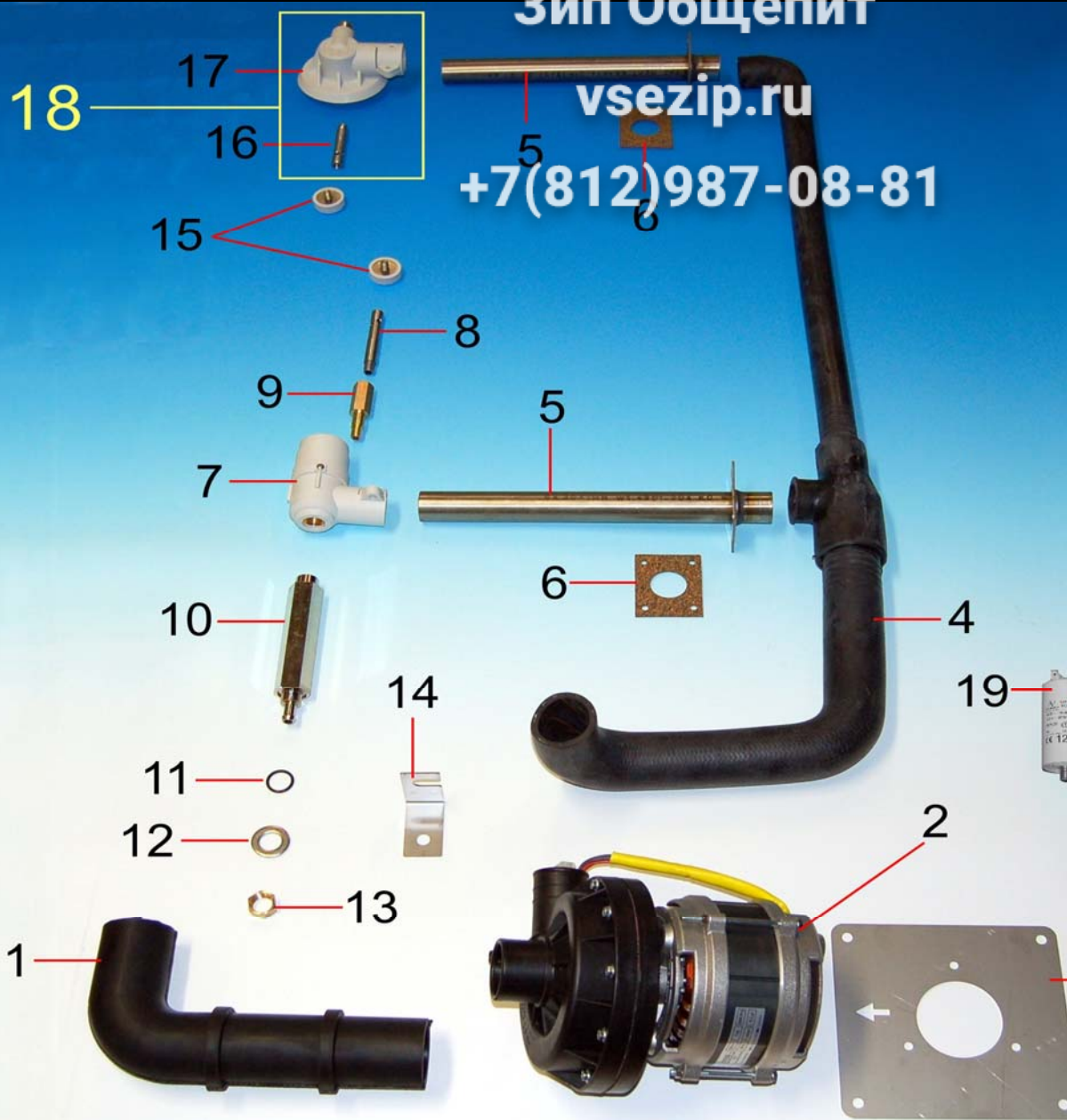

Pos.	Codice	Descrizione	Description	De
1	GA38	Manicotto aspirazione	Inlet hose	Manchon aspiration
2	EP100	Elettropompa 1 hp 230v 50hz aperta	Wash pump,1hp 230V 50hz, open	Elettropompe ouverte
3	AM0SQFP6	Piastra sostegno pompa	Washpump mounting plate	Plaque fixation pompe
4	GLMSI61P	Manicotto mandata superiore-inferiore	Wash outlet hose,double	Durite de refoulement
5	LSI6361P	Tubo inox mandata superiore-inferiore	Steel extension tube	Tuyau inox superie
6	LS026	Guarnizione sughero	Cork seal	Joint en liege
7	LI029CAB	Supporto mozzo inferiore	Bottom boss assy	Support interieur co
8	LS08	Perno inox lavaggio lungo 85mm	Lower spindle,85mm	Pivot inox lavage l
9	LI330	Prolunga ottone perno inox	Spindle extension	Extension pivot
10	LI6333	Supporto risciacquo	Lower support column	Support rinçage
11	OR122	Or 122	O ring 122	Joint 122
12	VRP18I	Rondella piana diametro 18mm	Washer, diam. 18mm	Rondelle, diam. 18
13	D038A	Dado 3/8"	3/8" brass nut	Ecrou serrage 3/8"
14	AM0SQFD6	Squadretta dosatore brillantante	Bracket for rinse aid injector	Support pour douse

Зип Общежит

vsezip.ru

+7(812)987-08-81

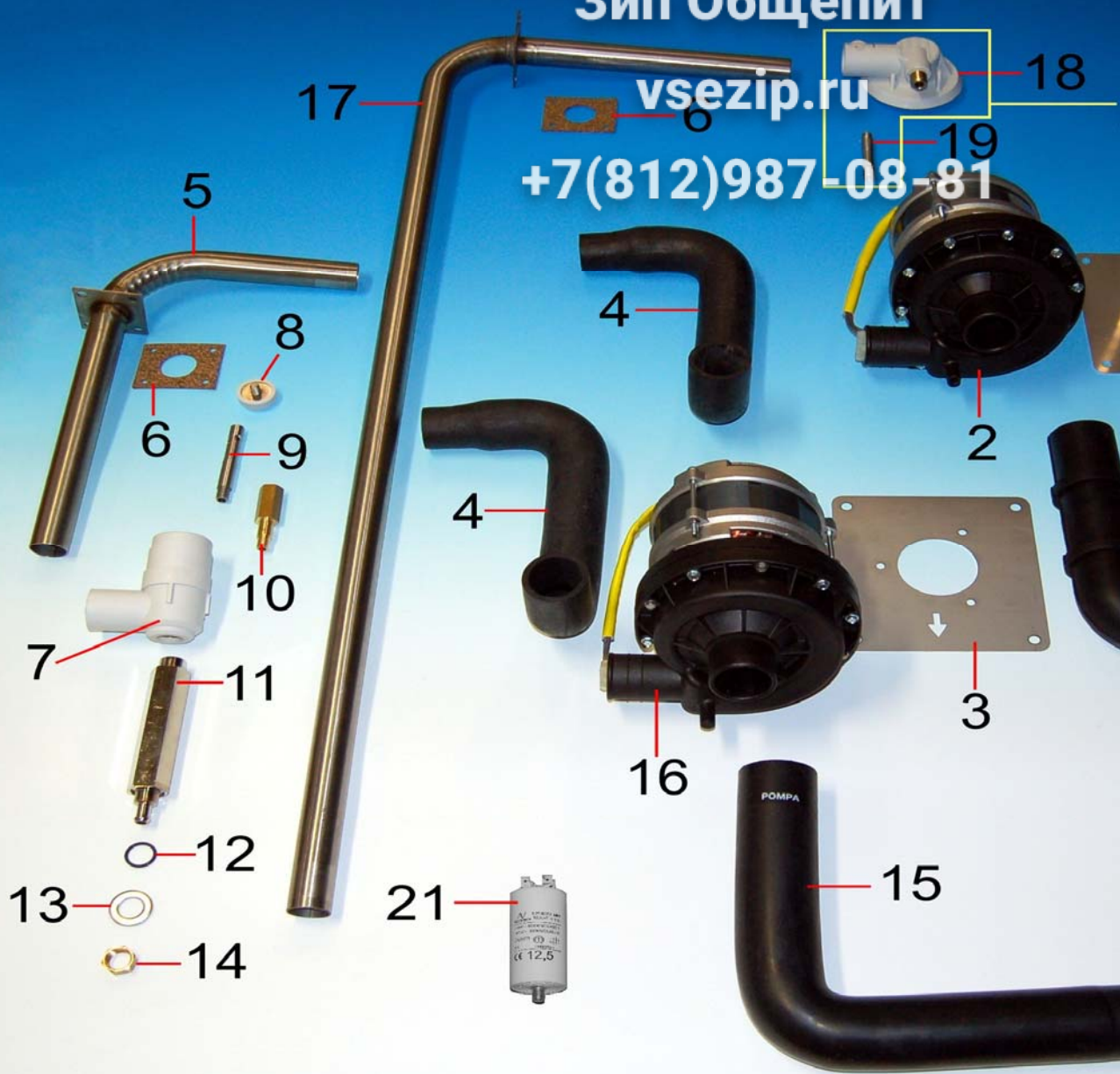

Pos.	Codice	Descrizione	Description	De
1	GA38	Manicotto aspirazione	Wash inlet hose, upper pump	Manchon aspiration
2	EP100	Elettropompa 1 hp 230v 50hz aperta	Wash pump, 1,0 hp, open nipple	Pompe de lavage, ouv
3	AM0SQFP6	Piastra sostegno pompa inox	Washpump mounting plate, steel	Plaque fixation pomp
4	LI6312	Manicotto mandata	Outlet hose, lower wash pump	Manchon refouleme
5	LI6382	Tubo inox mandata inferiore	External wash pipe, lower, steel	Tuyau inox exterieu
6	LS026	Guarnizione sughero	Cork seal	Joint en liege
7	LI029CAB	Supporto mozzo inferiore completo	Bottom boss assy	Support inferieur co
8	LS09PB	Nottolino fissaggio girante	Spindle retaining nut complete	Ecrou pour pivot
9	LS08	Perno inox lavaggio, l. 85mm	Lower spindle	Pivot inox inferieur,
10	LI330	Prolunga ottone perno inox	Spindle extension, brass	Extension pivot, lai
11	LI6333	Supporto risciacquo	Lower support column	Support rinçage
12	OR122	Or 122	O ring 122	Joint torique
13	VRP18I	Rondella piana diametro 18mm	Washer	Rondelle
14	D038A	Dado 3/8"	3/8" brass nut, brass	Ecrou serrage 3/8"
15	GASA8	Manicotto aspirazione	Wash inlet hose lower pump	manchon aspirati

Зип Общепит

vsezip.ru

+7(812)987-08-81

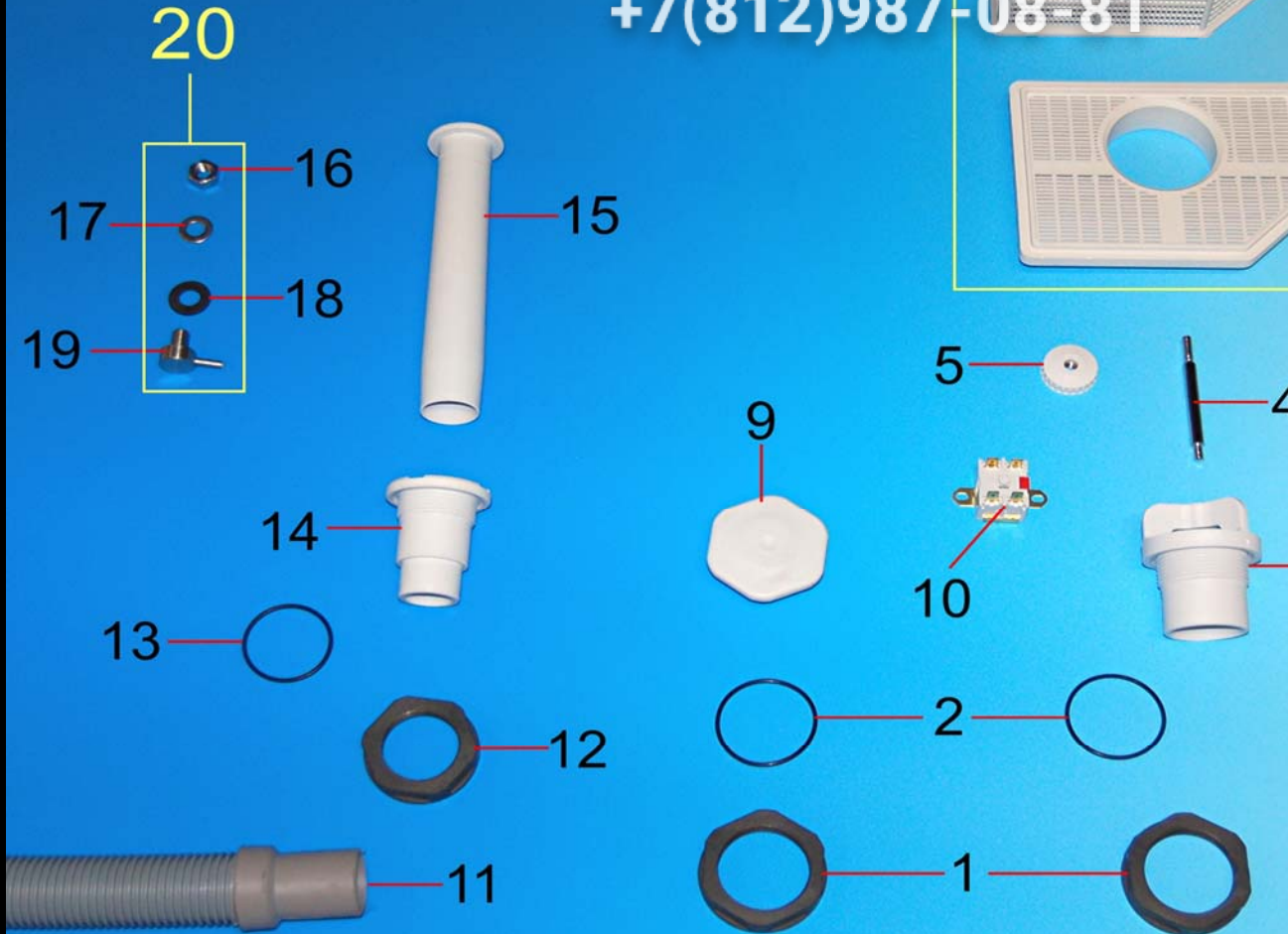
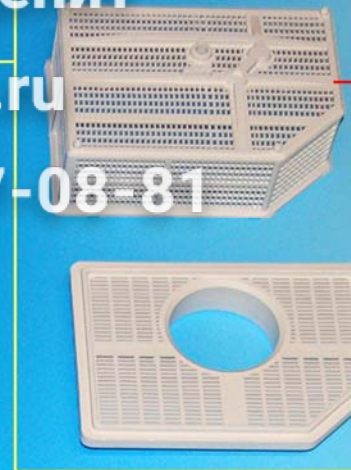

Pos.	Codice	Descrizione	Description	De
1	DP112	Dado 1"1/2 gas	Plastic nut 1"1/2	Écrou plastique po
2	OR3187	Or 3187	O ring 3187	Joint torique bonde
3	GA311B	Piletta aspirazione	Filter boss	Bonde d'aspiration
4	GA61220T	Tirante filtro	Filter retaining rod	Tige de filtre
5	GA013B	Ghiera fissaggio filtro aspirazione	Filter retaining nut	Écrou de filtre
6	GA315RAV0	Piastra inferiore filtro aspirazione "V0"	Wash filter base,VO	Plaque filtre d'aspir
7	GA315RV0	Filtro aspirazione "V0"	Wash filter body, VO	Filtre d'aspiration, "
8	GA315RCB	Filtro aspirazione "V0" completo	Wash filter complet, VO	Filtre d'aspiration c
9	AM0TA46B	Tappo foro 1"1/2 gas	Blanking cover 1"1/2	Bouchon 1" 1/2
10	CESV001	Termostato sicurezza vasca	Safety switch, wash tank	Thermostat, sécur
11	GS330	Tubo scarico, diametro 31,5mm	Waste outlet hose, diam.31,5mm	Tuyau de vidange,
12	DP114	Dado 1"1/4 gas	Plastic nut	Écrou plastique po
13	OR3168	Or 3168	O-ring 3168	Joint Or 3168
14	GS317B	Piletta scarico vasca	Drain boss	Bonde de vidange
15	GS6013B	Troppo pieno	Drain plug or standpipe	Trop-plein
16	VD10I	Dado esagonale, mm. 10	Tab nut, mm.10	Ecrou, 10mm
17	VRP10I	Rondella piana, diametro 10	Flat washer, diam.10mm	Rondelle, diam. 10

Зип Общепит

8

vsezip.ru

+7(812)987-08-81

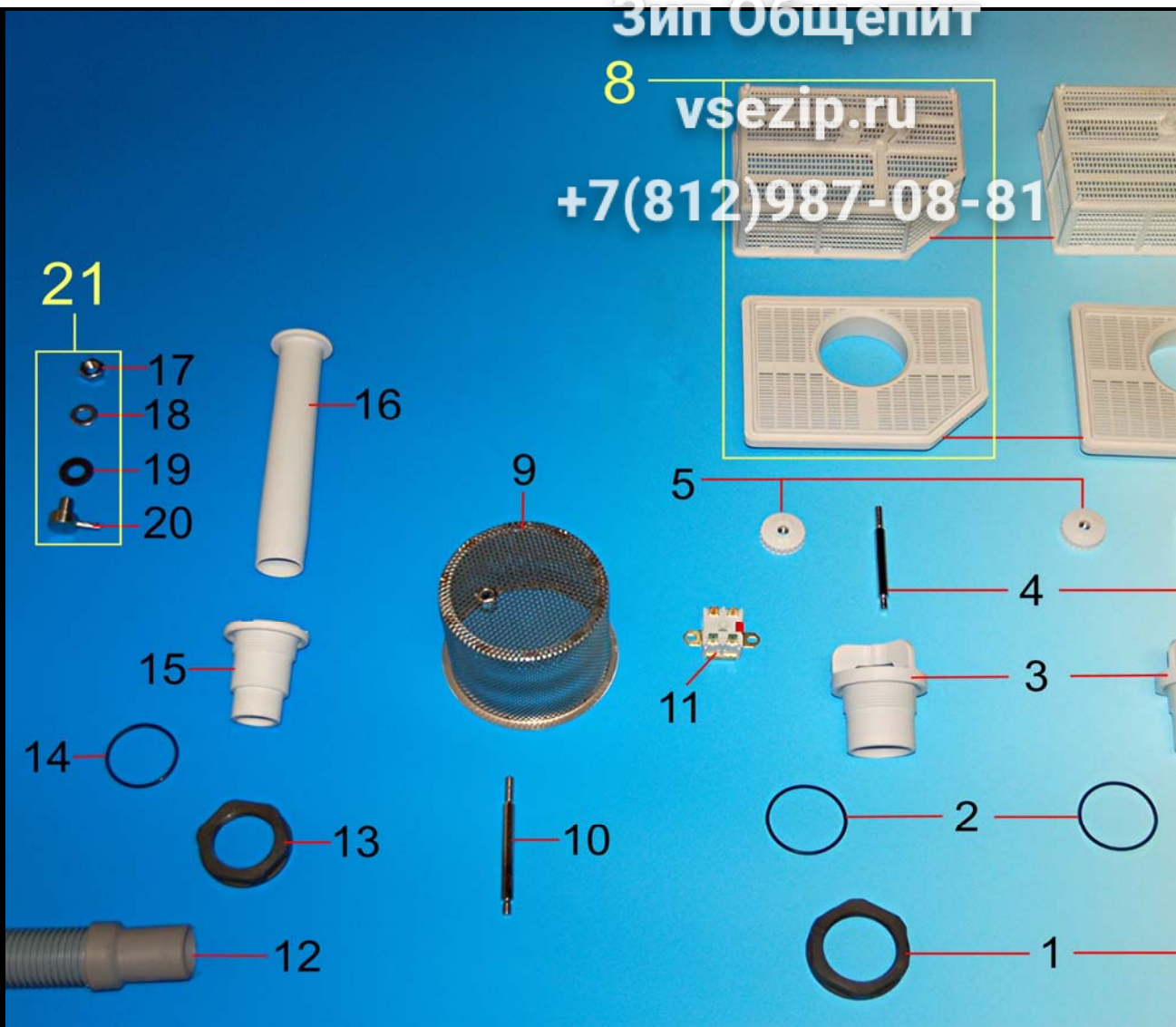

Pos.	Codice	Descrizione	Description	De
1	DP112	Dado 1"1/2 gas	Plastic nut 1"1/2	Écrou plastique po
2	OR3187	Or 3187	O ring 3187	Joint torique bonde
3	GA311B	Piletta aspirazione	Filter boss	Bonde d'aspiration
4	GA61220T	Tirante filtro	Filter retaining rod	Tige de filtre
5	GA013B	Ghiera fissaggio filtro aspirazione	Filter retaining nut	Écrou de filtre
6	GA315RAV0	Piastra inferiore filtro aspirazione "V0"	Wash filter lower body, "VO"	Plaque filtre d'aspira
7	GA315RV0	Filtro aspirazione "V0"	Wash filter upper body, "VO"	Filtre d'aspiration, "
8	GA315RCB	Filtro aspirazione "V0" completo	Wash filter lower body, "VO"	Filtre d'aspiration c
9	GA6142	Filtro aspirazione inox	Stainless steel round filter	Filtre d'aspiration
10	GA61220TA	Tirante filtro	Filter retaining rod	Tige de filtre
11	CESV001	Termostato sicurezza vasca	Safety switch, wash tank	Thermostat, sécur
12	GS330	Tubo scarico, diametro 31,5mm	Waste outlet hose, diam.31,5mm	Tuyau de vidange,
13	DP114	Dado 1"1/4 gas	Plastic nut	Écrou plastique po
14	OR3168	Or 3168	O-ring 3168	Joint OR 3168
15	GS317B	Piletta scarico vasca	Drain boss	Bonde de vidange
16	GS6013B	Troppo pieno	Drain plug or standpipe	Trop-plein
17	VD10I	Dado esagonale, mm. 10	Tab nut, mm.10	Ecrou , 10mm
18	VRP10I	Rondella piana, diametro 10mm	Flat washer, diam.10mm	Rondelle, diam. 10
19	G24112	Guarnizione portacomma, dim. 24x11x2	Seal, dim. 24x11x2	Joint, dim. 24x11

Зип ОбщениТ
vsezip.ru

+7(812)987-08-81



Pos.	Codice	Descrizione	Description	Des
1	VVTE580Z	Vite TE 5x80	Special screw for motor assy, 5x80	Vis 5x80
2	VR5I	Rondella dentata diam 5	Special tab washer	Rondelle éventailé
3	VD5I	Dado esagonale m 5	Special hexagon nut	Ecrou M5
4	VVTE570Z	Vite TE 5x70	Special screw for motor assy, 5x70	Vis 5x70
5	EP05M5	Calotta alluminio (filettata)	Motor endplate NDE	Calotte aluminium p
6	EP011	Anello compensazione pompe	Bearing ring	Boucle compensati
7	EP07	Cuscinetto per motore pompa	Motor bearing	Roulement pour mo
8	EP7589	Rotore con albero	Rotor	Rotor de compressi
9	EP7510	Statore avvolto	Stator	Stator pompe
10	EP05	Calotta alluminio	Motor endplate DE	Calotte aluminium p
11	VVTE512I	Vite 5x12	Special screw	Vis 5x12
12	EP755TP	Fondo pompa grande	Impellor back plate	Fond pompe
13	EP04	Anello tenuta	Rotating shaft seal	Presse étoupe
14	EP752NT	Guarnizione pompa	Cork gasket	Joint pompe
15	EP753	Girante pompa grande	Impellor	Turbine de pompe
16	EP751TP	Corpo pompa grande aperto	Impellor housing, open nipple	Corps pompe 1hp r
17	VATE4232Z	Vite autofilettante 4,2x32	Special screw	Vis 4,2x32
18	EP751TPC	Corpo pompa grande chiuso	Impellor housing, closed nipple	Corps pompe 1hp

8vsezip.ru

+7(812)987-08-81

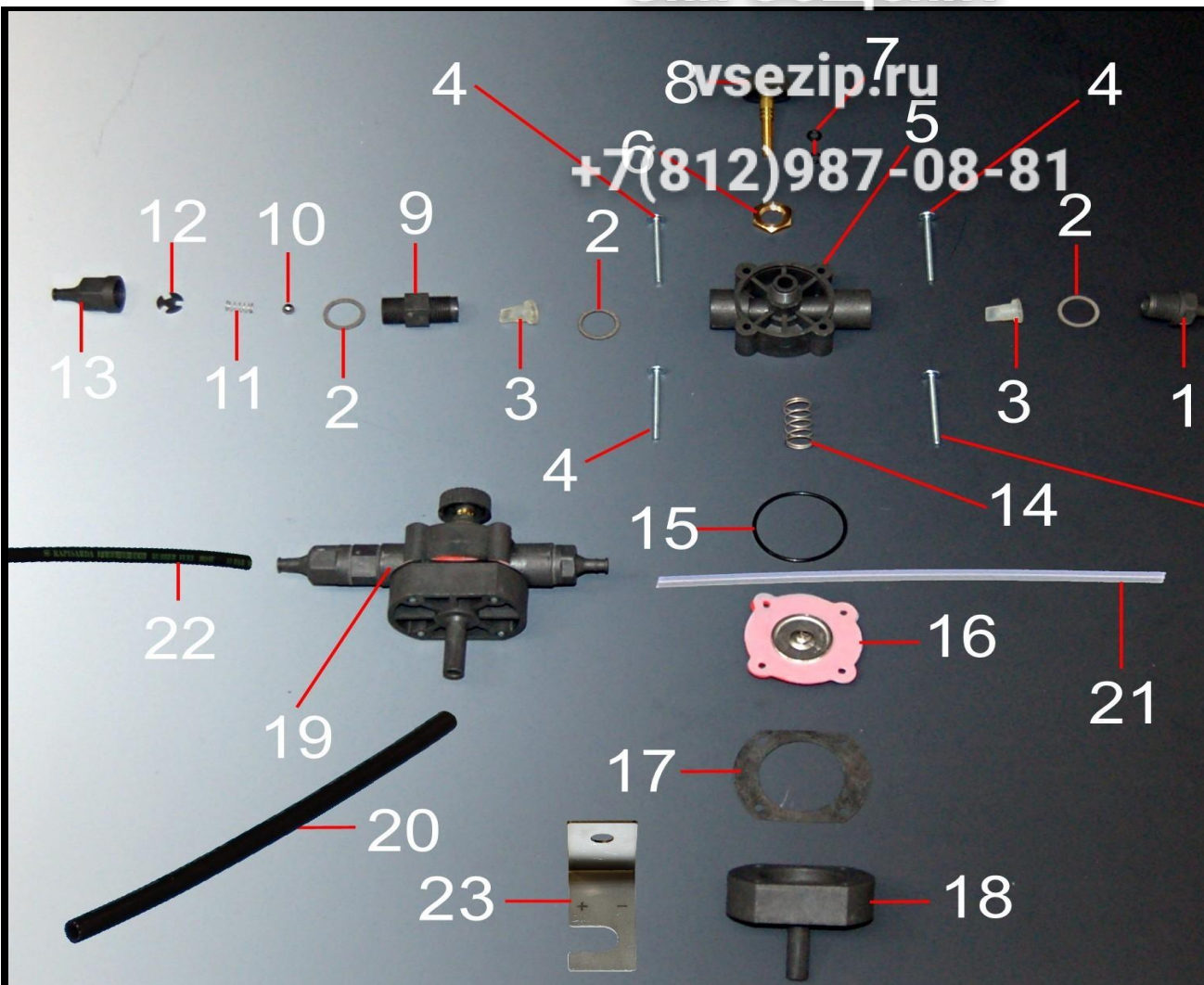

Pos.	Codice	Descrizione	Description	De
1	DS10NT	Raccordo stringitubo	Inlet nipple	Raccord
2	G16221F	Guarnizione fibra 17x22x1,5	Seal for injector	Joint pour injecteur
3	DS8S	Valvolina silicone	Non return valve, rubber	Soupape en silicone
4	VVTCC445Z	Vite fissaggio	Special screw	Vis serrage
5	DS3	Corpo dosatore	Injector front body	Corps doseur produit
6	DS24	Dado 20x4x14	Brass nut 20x4x14	Ecrou 20x4x14
7	OR103	Or 103	O ring 103	Or 103
8	DS1	Volantino dosatore	Adjusting screw	Manette pour doseur
9	DSVNR12	Raccordo valvola non ritorno	Housing for non return valve	Raccord soupape
10	DSVNR13	Sfera 1/4"	1/4" Ball for non return valve	Bille 1/4"
11	DSVNR14	Molla valvola non ritorno	Spring for non return valve	Ressort clapet anti
12	DSVNR16	Dischetto valvola non ritorno	Special disk for non return valve	Petit disque clapet
13	DSVNR17NT	Raccordo stringitubo valvola non ritorno	Outlet nipple	Raccord clapet anti
14	DS4	Molla membrana	Spring for diaphragm	Ressort pour men
15	OR422	Or 42x2	O ring 42x2	Or 42x2
16	DS06M3	Membrana completa	Diaphragm	Membrane
17	DS15	Guarnizione 64x50x1	Seal 64x50x1 for diaphragm	Joint 64x50x1
18	DS15A	Supporto posteriore	Injector rear body	Support postérieur
19	DSAM3NT	Dosatore brillantante completo assemblato	Rinse aid injector, complete	Doseur produit de
20	TG1117	Tubo gomma 11x17	Standard rinse hose 11mm bore	Tuyau caoutchou

Зип Общепит

2 vsezip.ru
 +7(812)987-08-81

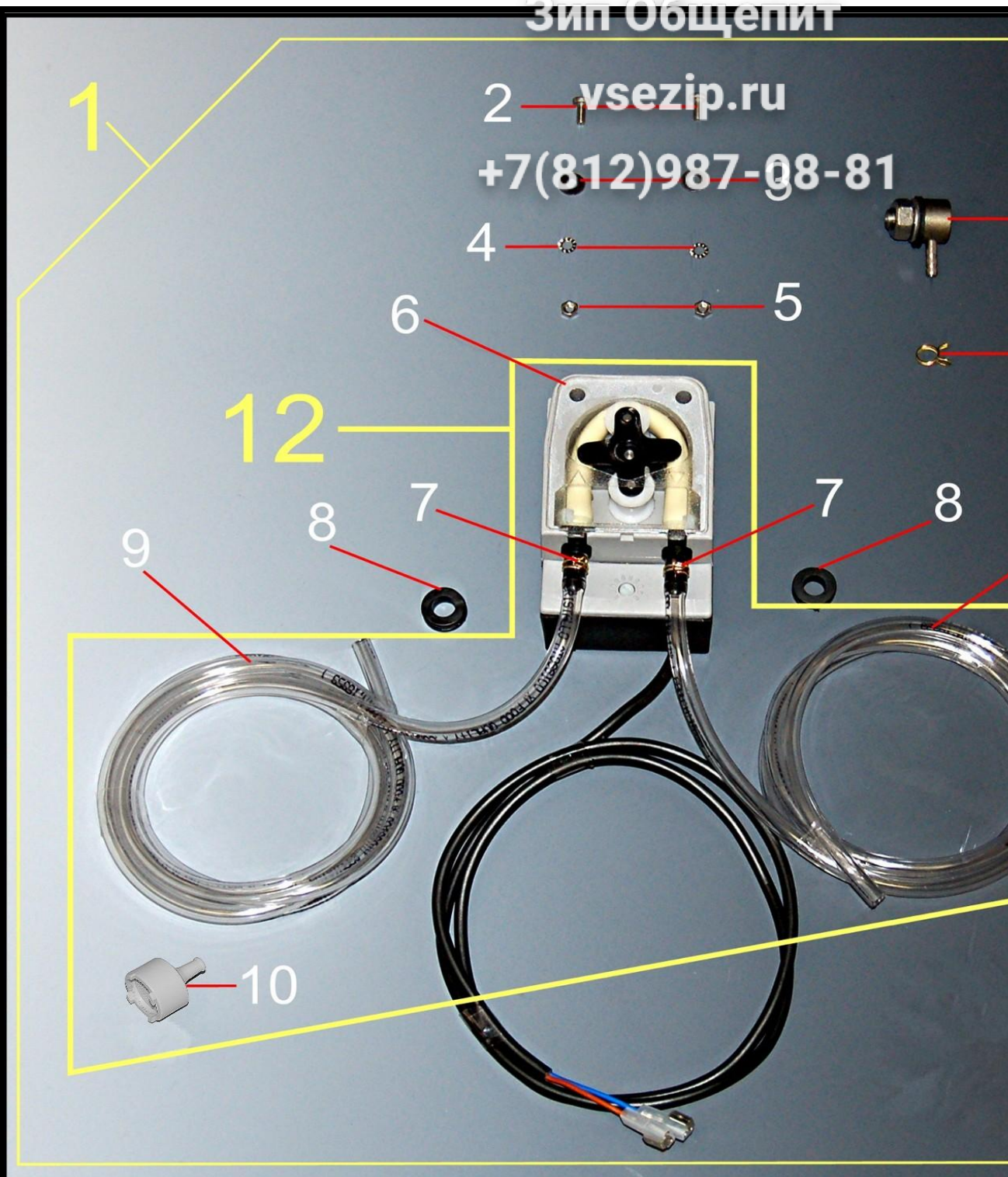

Pos.	Codice	Descrizione	Description	De
1	KD0SDETE61PS	Kit dosatore detergente	Detergent kit complete	Kit doseur produit c
2	VVTCC410I	Vite 4X10mm	Screw, 4xm10mm	Vis, 4x10mm
3	VRGB4I	Rondella grembialina 4x12mm	Washer , 4x12mm	Rondelle, 4x12mm
4	VR4I	Rondella dentata diam. 4mm	Tab washer , D 4	Rondelle à denture
5	VD4I	Dado esagonale M4	Nut, M4	Ecrou, M4
6	D0SDETE61PS	Dosatore detergente 50-60 HZ	Soap injector 50-60 HZ	Doseur produit de l
7	FAM710	Fascetta a molla dosatore	Spring clip for soap tube	Collier doseur pro

Зип Общепит

2 — vsezip.ru
+7(812)987-08-81

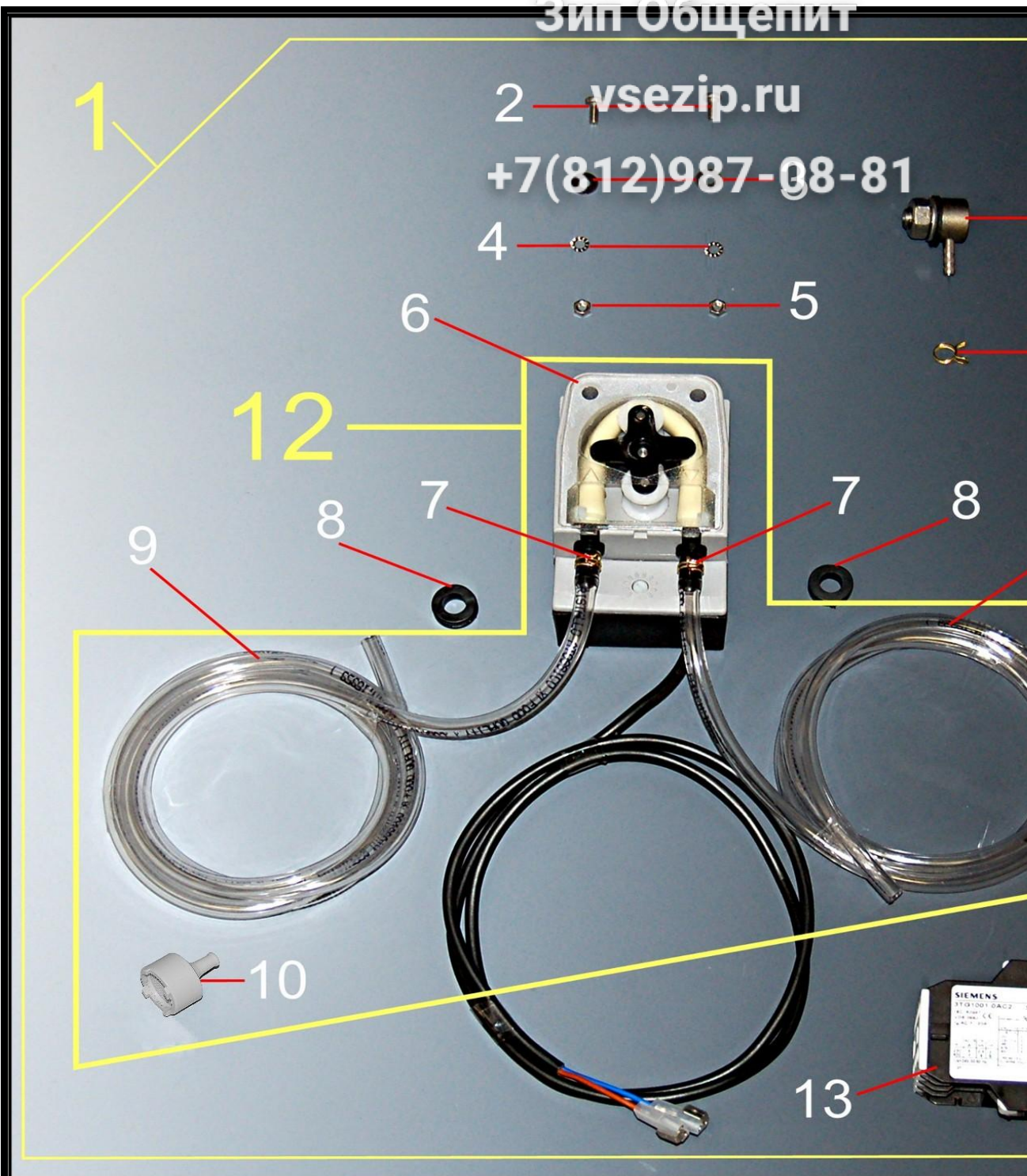

Pos.	Codice	Descrizione	Description	De
1	KD0SDETE62P	Kit dosatore detergente	Detergent kit complete	Kit doseur produit c
2	VVTCC410I	Vite 4x10 mm	Screw, 4 x 10 mm	Vis , 4x10mm
3	VRGB4I	Rondella grembialina 4x12mm	Washer, 4x12mm	Rondelle 4x12mm
4	VR4I	Rondella dentata diam. 4mm	Tab washer, D 4	Rondelle, diam. 4m
5	VD4I	Dado esagonale M4	Nut, M4	Ecrou, M4
6	D0SDETE62P	Dosatore detergente 50-60 hz	Soap pump hpusing 50-60HZ	Doseur produit de l
7	FAM710	Fascetta a molla dosatore	Spring clip for soap tube	Collier dosateur pro
8	AM0PF10	Passafilo diam. 10mm	Grommet for soap tube, diam. 10mm	Protection de cable

Зип Общепит

vsezip.ru

+7(812)987-08-81

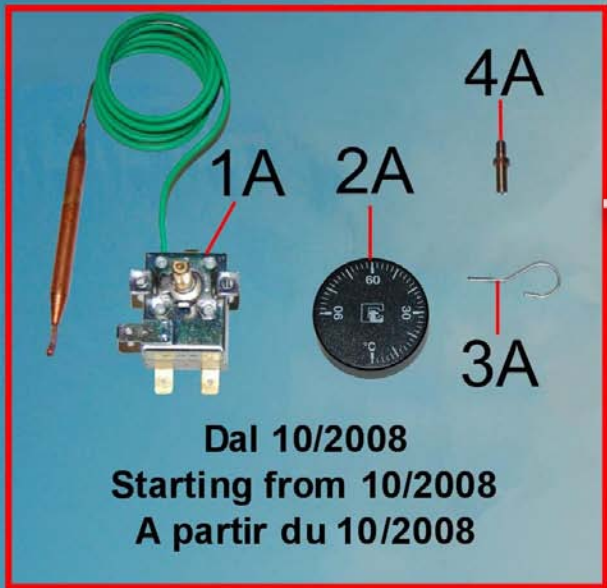

Dal 10/2008
Starting from 10/2008
A partir du 10/2008

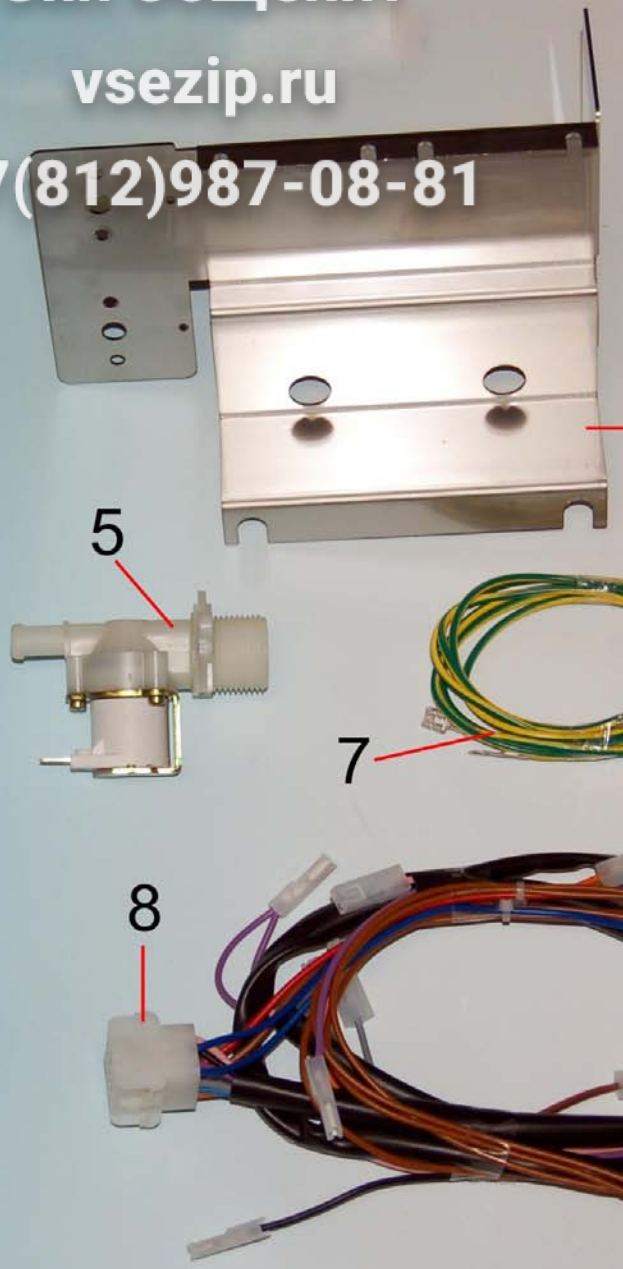
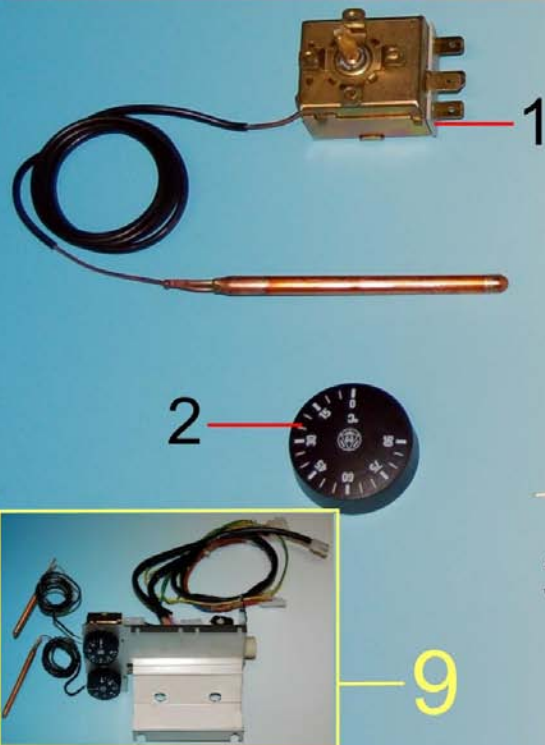

Pos.	Codice	Descrizione	Description	Dè
1	CETB85	Termostato boiler regolabile	Adjustable control thermostat	Termostat surchaff
1A	CETB85CAM	Termostato boiler regolabile (2008)	Adjustable boiler thermostat (2008)	Thermostat surcha
2	CEMTB	Manopola termostato	Thermostat knob	Manette thermostat
2A	CEMTBCAM	Manopola termostato (2008)	Thermostat knob (2008)	Manette thermosta
3	CETMM42	Molla manopola termostato	Locking spring for thermostat knob, diam42mm	Ressort poignée, diam
3A	CETMMCAM	Molla manopola (2008)	Locking spring for thermostat knob (2008)	Ressort poignée (2
4	CETFM42	Perno fermo manopola	Locking pin for thermostat knob	Goujon arrete poign
4A	CETFMCAM	Perno fermo manopola (2008)	Locking pin for thermostat knob (2008)	Goujon arrete poign
5	CEEV1	Elettrovalvola 1a via 220 volt	Solenoid valve, 1-way, 220V	Electrovanne 1 voi
6	AM0SQFTDE6	Squadretta fissaggio componenti	Bracket	Support thermostat
7	CECBCTTA	Catenaria terra tipo "TA"	Earth cable, type "TA"	Cable à la terre, m
8	CECBTPE61PS05	Cablaccio 220 volt	Loom. 220 V	Cablage. 220V

Зип Общепит

vsezip.ru

+7(812)987-08-81

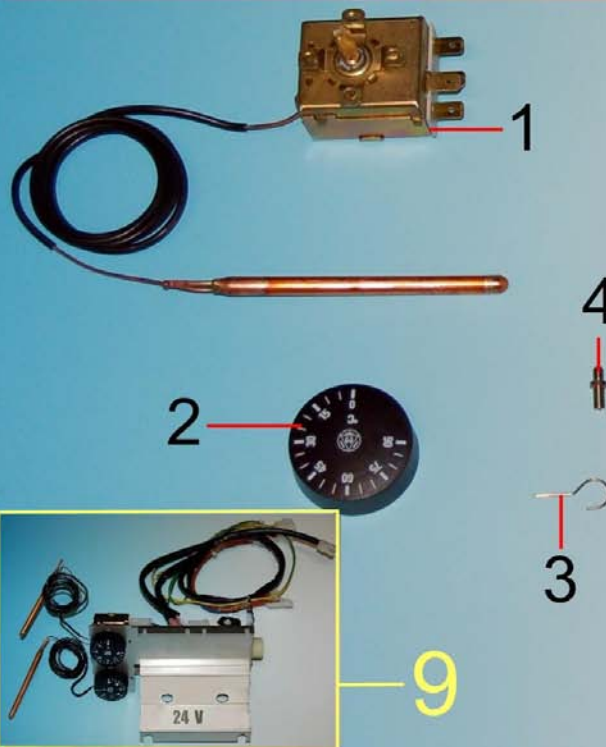
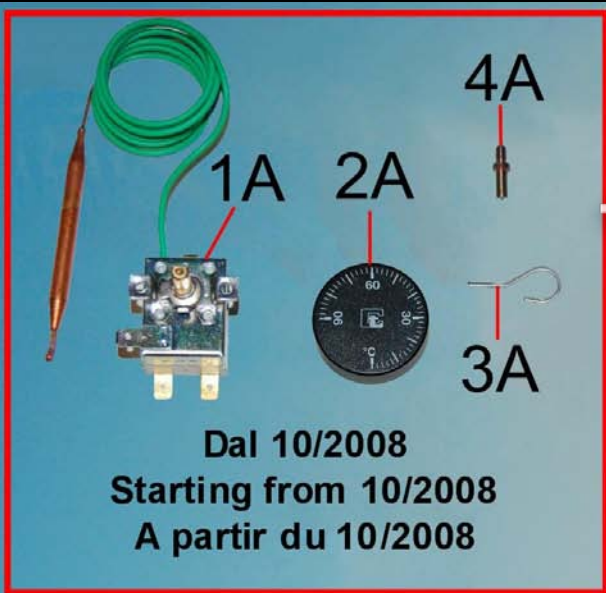

Pos.	Codice	Descrizione	Description	De
1	CETB85	Termostato boiler regolabile	Adjustable boiler thermostat	Thermostat surcha
1A	CETB85CAM	Termostato boiler regolabile (2008)	Adjustable boiler thermostat (2008)	Thermostat surcha
2	CEMTB	Manopola termostato	Thermostat knob	Manette thermosta
2A	CEMTBCAM	Manopola termostato (2008)	Thermostat knob (2008)	Manette thermosta
3	CETMM42	Molla manopola	Locking spring for thermostat knob	Ressort poignée
3A	CETMMCAM	Molla manopola (2008)	Locking spring for thermostat knob (2008)	Ressort poignée (2
4	CETFM42	Perno fermo manopola	Locking pin for thermostat knob	Goujon arrete poig
4A	CETFMCAM	Perno fermo manopola (2008)	Locking pin for thermostat knob (2008)	Goujon arrete poig
5	CEEV124	Elettrovalvola 1 via 24V	Single solenoid valve 24V	Electrovanne 1 voi
6	AM0SQFTDE6	Squadretta fissaggio componenti	Bracket	Support thermosta
7	CECBCTTA	Catenaria terra tipo "TA"	Earth cable	Cable à la terre
8	CECBTPE62P05	Cablaggio 24 volt	Loom, pump thermostat	Cablage, thermost

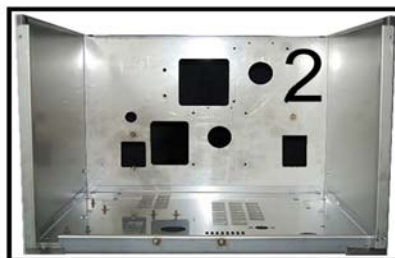
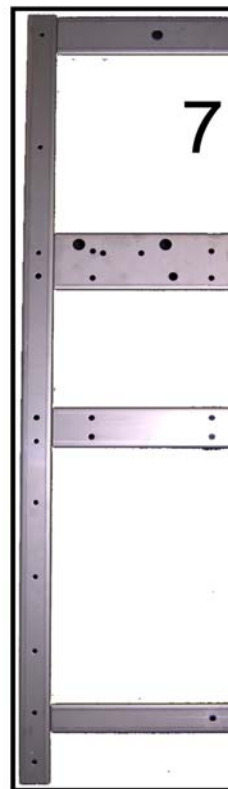
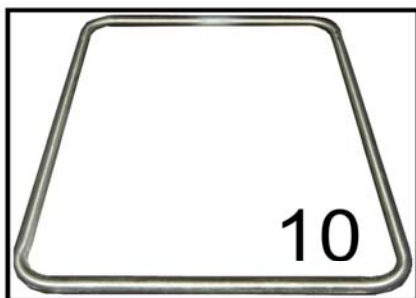
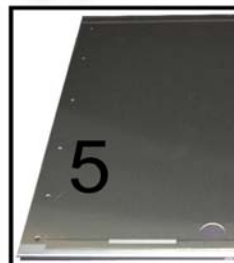
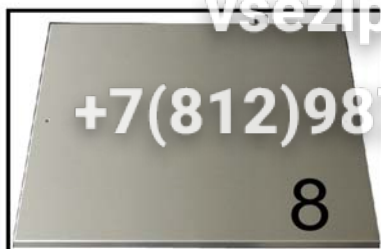
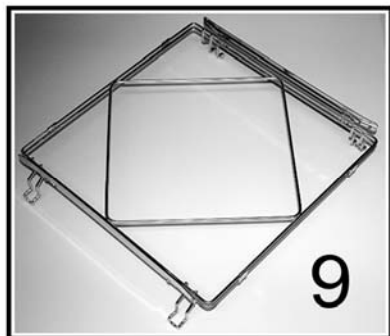

Pos.	Codice	Descrizione	Description	De
1	AM0165BC	Piedino inox con viti	Adjustable foot	Pied
2	GMBA605	Basamento carrozzeria capot	Base	Panneau socle inox
3	GMVA605	Vasca carrozzeria capot	Wash cabinet	Cuve
4	GMCP6	Capot (parte superiore)	Hood (without top cover)	Capote superieure
5	GMPS605	Pannello portaguida capot	Internal rear panel	Dosseret capot
6	GMGCP6	Guida scorrimento capot	Vertical guide for hood	Guide capot
7	GMTP605	Telaio posteriore capot	Rear machine frame	Chassis postérieur

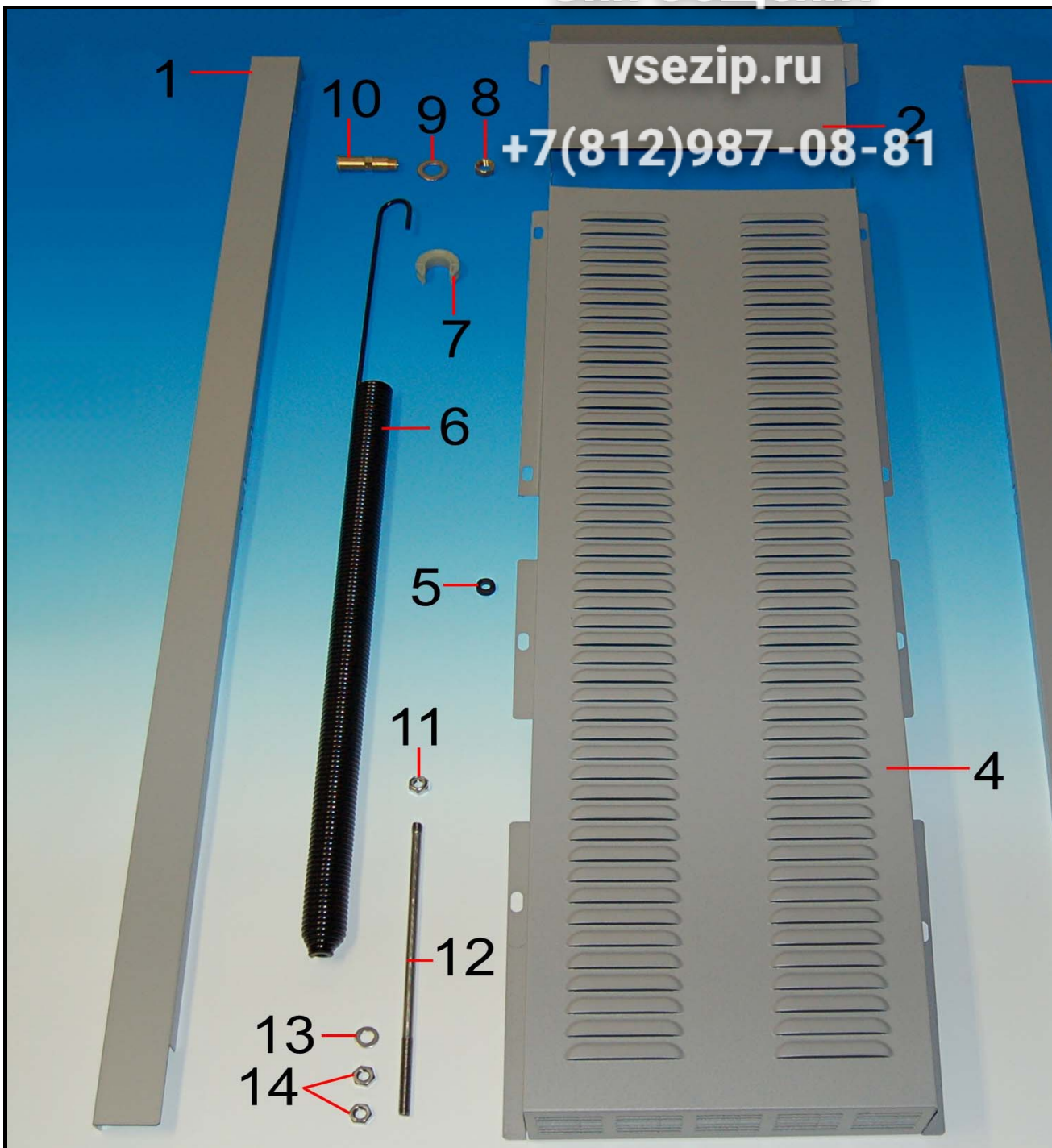

Pos.	Codice	Descrizione	Description	De
1	GMCTS605	Copertura telaio posteriore sinistra	Frame cover, rear left	Couverture chassis , p
2	GMCTC6S	Copertura telaio posteriore superiore	Rear cover, upper	Couverture chassis, p
3	GMCTD605	Copertura telaio posteriore destra	Frame cover, rear right	Couverture chassis , p
4	GMCTC6I05	Copertura telaio posteriore inferiore	Rear cover, lower	Couverture chassis , p
5	AM0PF10	Passafilo diam. 10 mm	Cable grommet, diam 10mm	Protection du cable
6	GMMML6261	Molla a trazione capot	Hood spring	Ressort inox de rap
7	GMMML6251	Puleggia aggancio molla capot	Spring seat	Support pour ress
8	D038A	Dado 3/8"	Brass lock nut 3/8"	Ecrou G 3/8"
9	VRP18I	Rondella piana diam. 18 mm	Washer, diam 18mm	Rondelle diam 18

Зип-Общепит

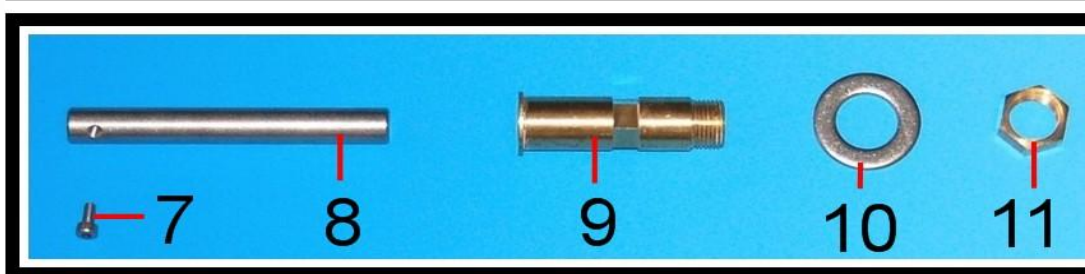
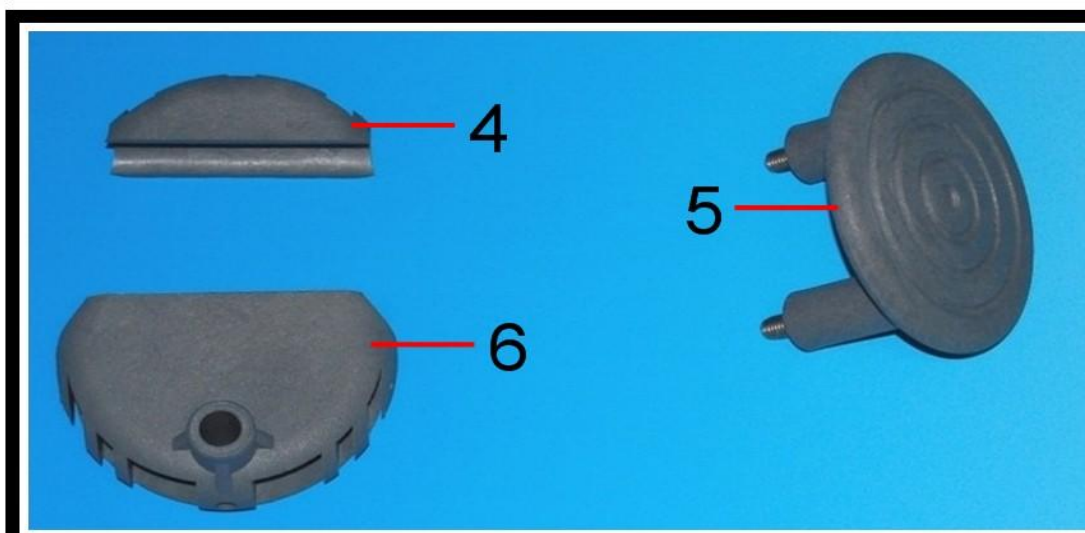
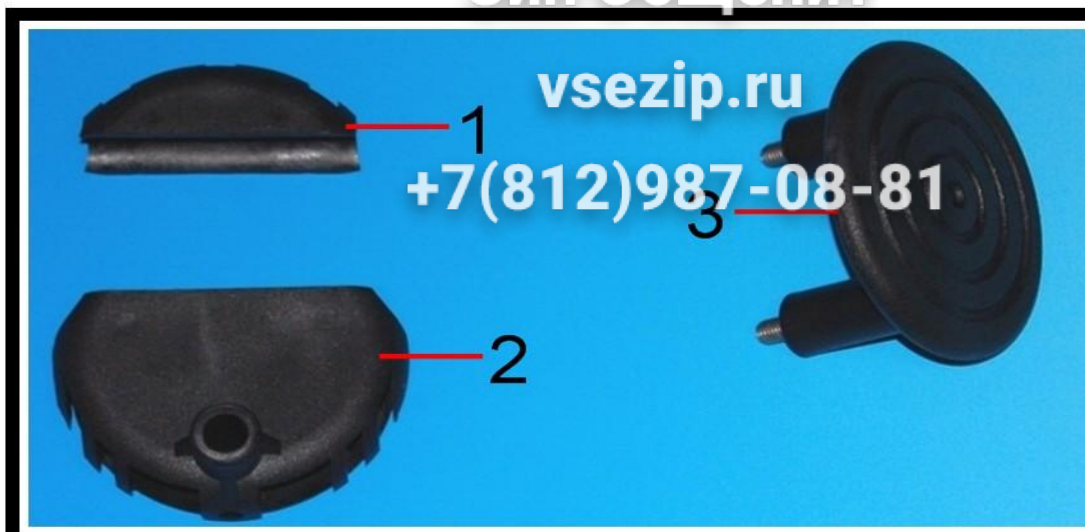

Pos.	Codice	Descrizione	Description	De
1	GMMN6161	Attacco maniglione superiore nero	Upper handle clamp, black	Attache pour poign
2	GMMN6171	Attacco maniglione inferiore nero	Handle locating block, black	Attache pour poign
3	GMMN6301	Attacco maniglione laterale nero	Lower handle clamp, black	Attache pour poign
4	GMMN6161GR	Attacco maniglione superiore grigio	Upper handle clamp, grey	Attache pour poign
5	GMMN6301GR	Attacco maniglione laterale grigio	Handle locating block, grey	Attache pour poign
6	GMMN6171GR	Attacco maniglione inferiore grigio	Lower handle clamp, grey	Attache pour poign
7	VVEI410I	Vite 4x10	Screw 4x10mm	Vis 4x10mm
8	GMMN6181	Perno snodo	Handle location pin	Axes tenue poigné
9	GMMN6191	Bussola perno snodo	Handle location bush	Douille pour axes
10	VRP18I	Rondella piana diam. 18mm	Washer flat. diam. 18mm	Rondelle plate. dia

Зип Общепит



Pos.	Codice	Descrizione	Description	Dé
1	LS013B	Manicotto aspirazione pompa scarico	Drain pump inlet hose	Durite d'aspiration p
2	FA3045	Fascetta tubo 30-45-13	Hose clip 30-45-13	Collier 30-45-13
3	CEPS5	Pompa scarico	Drain pump	Pompe de vidange
4	FA2532	Fascetta tubo 25-32-9	Hose clip 25-32-9	Collier 25-32-9
5	CEPS032	Tubo scarico pompa scarico	Drain pump waste outlet hose	Tuyau de vidange p
6	CEPU25A	Pulsante arancio	Drain switch, orange	Bouton orange pom
7	GS6013TB	Troppo pieno mod. 6 modificato	Drain plug or standpipe, special	Trop-plein
8	CECBKITPS6	Cablaggio kit pompa scarico mod. 6	Loom, drain pump system	Kit cablage pour po
9	CEPSTFB	Timer pompa scarico	Drain pump timer	Temporisateur pom
10	CECTF	Teleruttore	Contactore	Contacteur
11	AM0SQFTTPS	Squadretta fissaggio timer teleruttore	Bracket for timer contactore	Plaque fixation temp
12	VVA3913I	Vite autofilettante 3,9x13 mm	Self-tapping screw 3,9x13 mm	Vis 3,9x13 mm
13	VVTCC410I	Vite 4x10 mm	Screw 4x10 mm	Vis 4x10 mm
14	VR4I	Rondella dentellata, diam 4mm	Tab washer, diam 4 mm	Rondelle à denture
15	CEPS6KIT	Kit completo pompa scarico mod. 6	Assembly kit for drain pump	Kit assemblage pom



Зип-Общепит

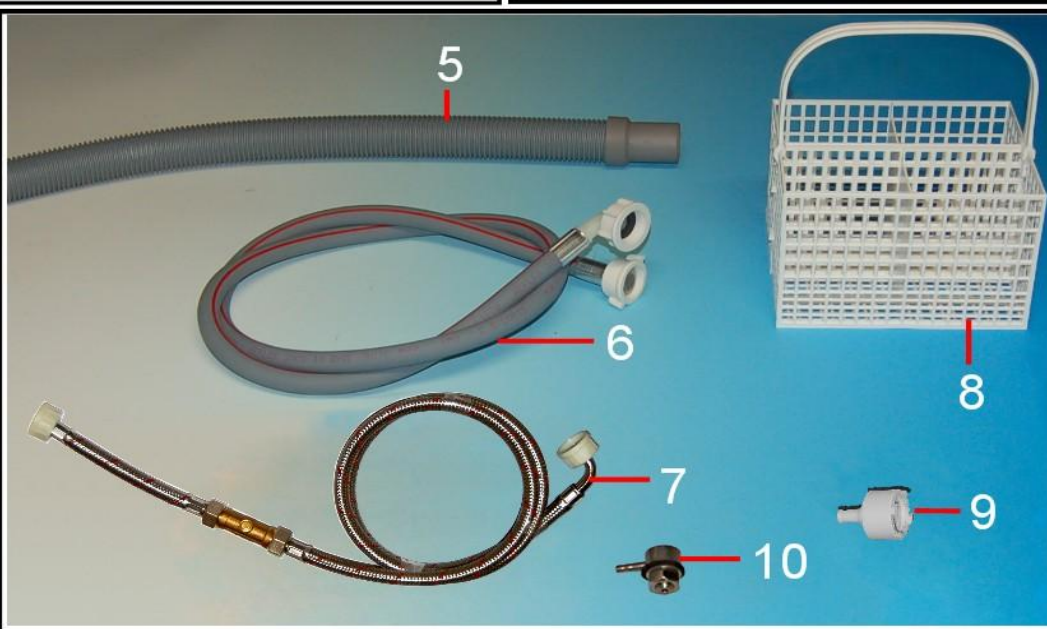

Pos.	Codice	Descrizione	Description	De
1	CQCV506PL	Cestello vassoi 50x50	Tray rack 50x50	Panier plateaux 50
2	CQIP5022P	Inserto 50x50 22 piatti	Dish insert 500 square 22 plates	Support 50x50 22 a
3	CQ5018PPL	Cestello 50x50 18 piatti	Plate rack 500 square	Panier 50x50 18 as
4	CQ50RPL	Cestello 50x50 bicchieri	Glass rack 500 square	Panier 50x50 pour
5	GS330	Tubo scarico Ø 31,5	Drain Pipe Diam 31,5	Flexible de vidange
6	TC34	Tubo carico "vde" mt. 2	Water Supply Hose, 3/4" BSP, 2 m	Tube entrée eau "v
7	VDCVGB	Doppia valvola con tubo carico	Water Supply Hose+Dbl Chk Valve,1,5m	Double valve avec
8	IP4PM	inserto porta posate 4 posti con maniglia	Cutlery basket with handle	Godet porte couver
9	D0SVFFC	Valvola di fondo con filtro	Foot valve with filter	Clapet avec filtre
10	GSDETPI10COMP	Iniettore inox completo	Soap Inlet Elbow Assembly	Injecteur inox com

Зип Общепит

vsezip.ru

+7(812)987-08-81



0309/101.02