

NP90-07

PENTOLE A GAS ED ELETTRICHE 50 LITRI
 GAS AND ELECTRIC HEATED BOILING PANS 50 LITERS
 MARMITES A GAZ ET ELECTRIQUES 50 LITRES
 GAS UND ELEKTROBEHEIZT KOCHKESSEL 50 LITERS

Зип Общени

vsezip.ru

+7(312)987-08-81

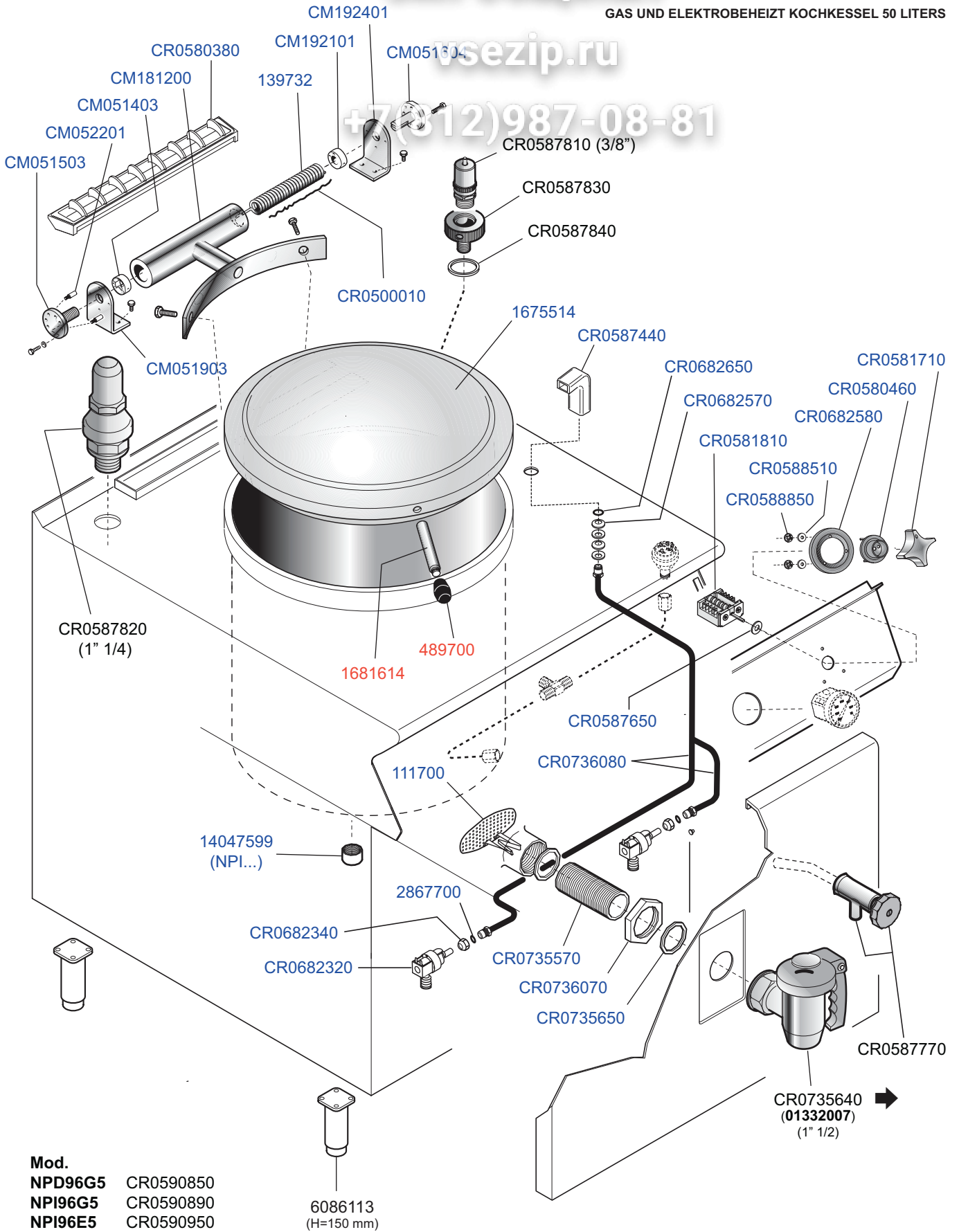

Mod.
NPD96G5 CR0590850
NPI96G5 CR0590890
NPI96E5 CR0590950

6086113
 (H=150 mm)

 MARENO INDUSTRIE ALI spa Mareno di Piave (TV)	ELABORATO:	APPROVATO:	GRUPPO:	DENOMINAZIONE:		
			Serie NP90	Impianto idraulico e mobile - Particolari comuni		
	DATA:	DATA:	PARTICOLARE:	REV. N.	DEL	DISEGNO N.
	21 Mag 2010	21 Mag 2010	Disegno esploso per ricambi	Z00	0510	3.P90.20
SOST. DIS.						

812)987-08-81

A

1" 1/2 CON - 50 Lit.
Cod. CR0735640 (01332007)
 (Serie N-Protagonista 70 e 90 - 2008)

- 1 Corpo cod. 22901077
- 2 Cilindro cod. 2100059
- 3 Calotta cod. 22901074
- 4 Vite fissaggio cilindro cod. 51007375
- 5 Vite di fermo rotazione cod. 31007370
- 6 Impugnatura atermica cod. 34003011
- 7 Pernone fissaggio impugnatura cod. 31004854
- 8 Anello tipo RA cod. 51000209
- 9 Dado cod. 22801231
- 10 Guarnizione cod. 34012778

Serial No.
 < MA020.....

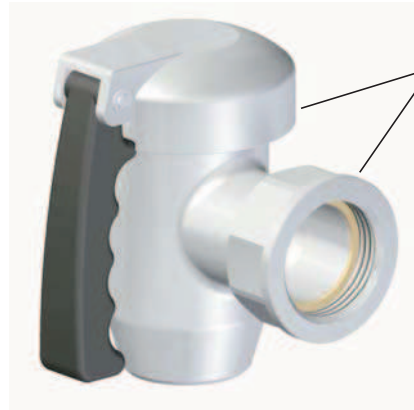

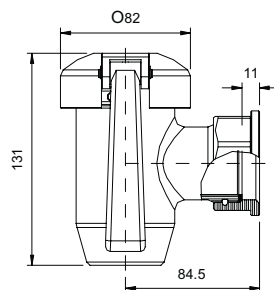

Cod. 77122400
 Grasso/Grease
 art. 36206760
 KLUBER Non Trop
 PLB DR
 (Cod. art. 572411)
 tubo da 100 g)

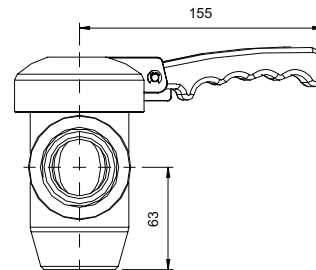

Dimens.
 mm



 MARENO INDUSTRIE ALI spa Mareno di Piave (TV)	ELABORATO:	APPROVATO:	GRUPPO:	DENOMINAZIONE:		
			Serie NP70 - 90	Rubinetti di scarico da 1" 1/2		
	DATA:	DATA:	PARTICOLARE:	REV. N.	DEL	DISEGNO N.
	16 Nov 2010	16 Nov 2010	Disegno esploso per ricambi 	Z00	1110	3.P90.20/2
	SOST. DIS.					

NP90-07

Зип Общепит
vsezip.ru

PENTOLE DA LITRI 50 - RISCALDAMENTO INDIRECTO ELETTRICHE

ELECTRIC HEATED (JACKETED) BOILING PANS

MARMITES ELECTRIQUES CHAUFFE INDIRECTE

DOPPELWANDIGE AUSF. - ELEKTROBEHEIZT KOCHKESSEL

+7(812)987-08-81

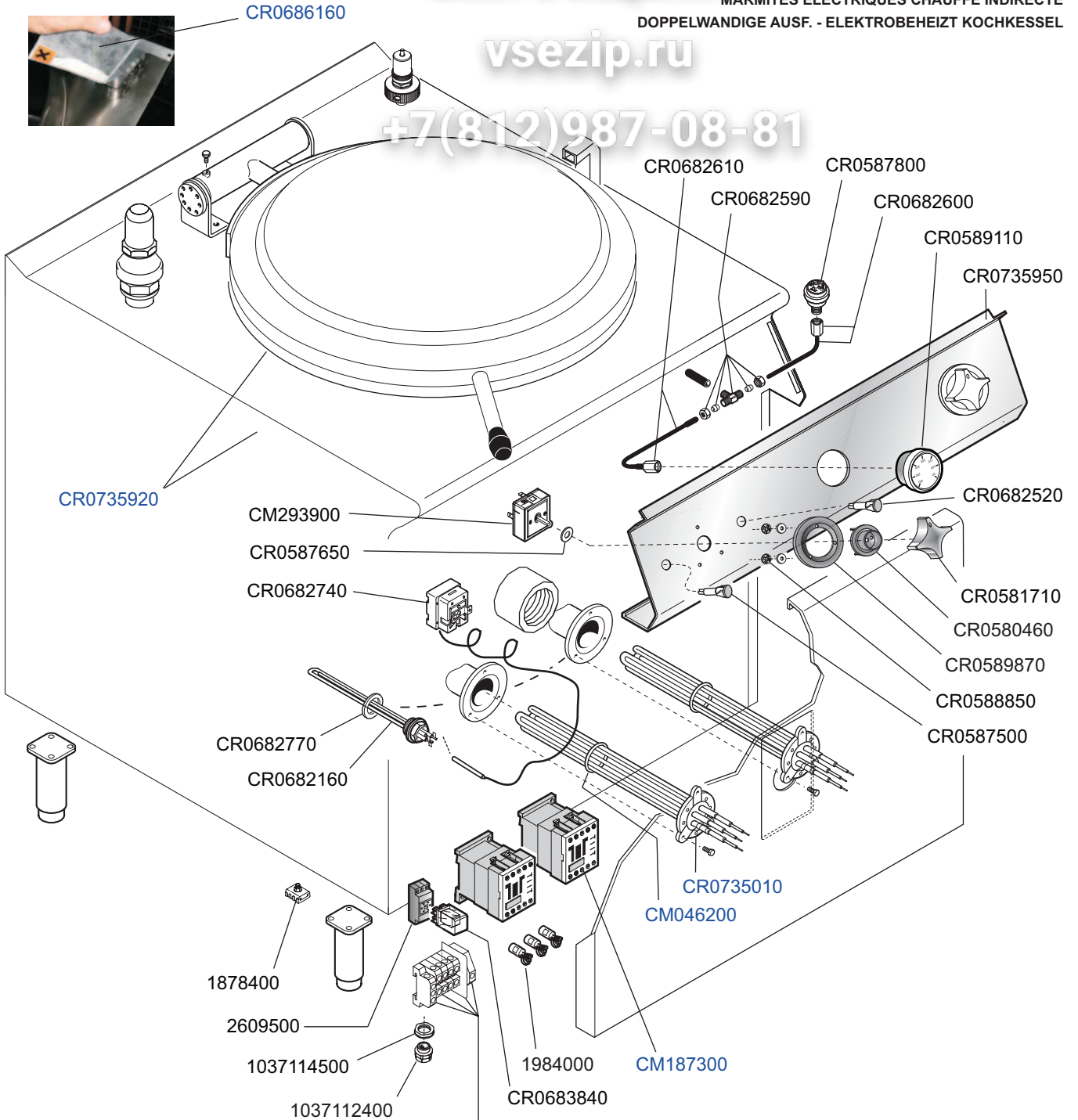

Mod.

NPI96E5 CR0590950

- MA20802799 1. MORSETTO TERRA 6 mm 8WA1 011-1PH00
- MA20802399 1. MORSETTO N.BLU 6 mm 8WA1 011-1BH23
- MA20802299 3. MORSETTO PASSANTE 6 mm 8WA1011-1DH11
- MA20802499 1. MORSETTO 16 mm 8WA1 204
- MA20806399 1. STAFFA TERMINALE 8WA1 808
- MA20806899 CARTELLINO TERRA 8WA8 848-2AA (10 mm)
- MA20806799 CARTELLINO N 8WA8 848-1AR (10 mm)
- MA20806499 CARTELLINO L 1 8WA8 848-2AC (10 mm)
- MA20806599 CARTELLINO L 2 8WA8 848-2AD (10 mm)
- MA20806699 CARTELLINO L 3 8WA8 848 2AE (10 mm)
- MA21499099 GUIDA OMEGA 35X7,5 AS (100 mm)

 MARENO INDUSTRIE ALI spa Mareno di Piave (TV)	ELABORATO:	APPROVATO:	GRUPPO:	DENOMINAZIONE:		
	LZ		Serie NP90	Impianto elettrico		
	DATA:	DATA:	PARTICOLARE:	REV. N.	DEL	DISEGNO N.
	23 Mag 2010	23 Mag 2010	Disegno esploso per ricambi	Z00	0510	3.P.90.25
SOST. DIS.						