

Зип Обществу  
vsezip.ru  
+7(912)987-08-81

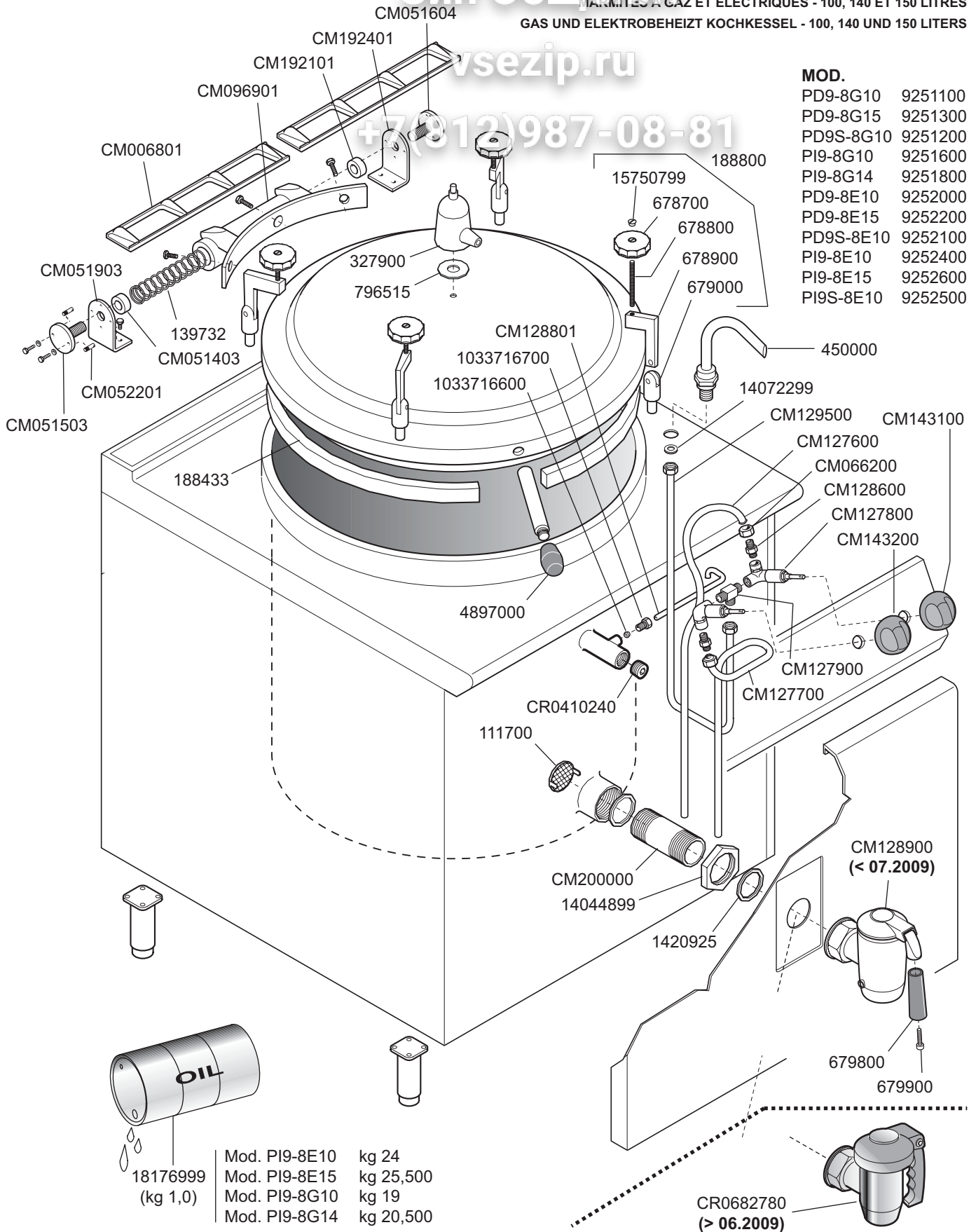

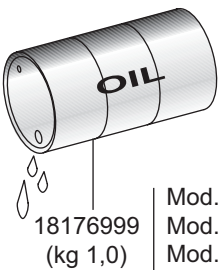

**MOD.**

PD9-8G10	9251100
PD9-8G15	9251300
PD9S-8G10	9251200
PI9-8G10	9251600
PI9-8G14	9251800
PD9-8E10	9252000
PD9-8E15	9252200
PD9S-8E10	9252100
PI9-8E10	9252400
PI9-8E15	9252600
PI9S-8E10	9252500



18176999	Mod. PI9-8E10	kg 24
(kg 1,0)	Mod. PI9-8E15	kg 25,500
	Mod. PI9-8G10	kg 19
	Mod. PI9-8G14	kg 20,500

CR0682780 (> 06.2009)

 <b>MARENO INDUSTRIE ALI spa</b> Mareno di Piave (TV)	ELABORATO:	APPROVATO:	GRUPPO:	DENOMINAZIONE:		
	DATA:	DATA:	PARTICOLARE:	REV. N.	DEL	DISEGNO N.
	10 Mar 1999	10 Mar 1999	Disegno esploso per ricambi	Z03	0309	3.P.14
	SOST. DIS.	Z02 0304 3.P.14				

**2" CON - 100, 140, 150 Lit.**  
**Cod. CM128900** (01301019)  
 (Serie Protagonista 90 - 1999/2008)  
 Serial No. < MA020167179

**A**

36204851  
 34003013  
 1420925  
 1420925

**Cod. 77122400** - Grasso/Grease 36206760  
 (KLUBER Non Trop PLB DR (Cod. art. 572411) tubo da 100g)

**2" OR - 100, 140, 150 Lit.**  
**Cod. CM128900** (01301019)  
 (Serie Protagonista 90 - 2009)  
 Serial No. < MA020167179

**B**

77122600 (34003012)  
 77122800 (31004866)  
 77121900 OR 34044795 (n. 3 pz.)

**Cod. 77122300** - Grasso/Grease 36206780  
 (LOXEAL 4 silicónico al PTFE (Cod. art. 804004) tubo da 100g)

**2" OR - 100, 140, 150 Lit.**  
**Cod. CR0682780** (01321009)  
 (Serie N-Protagonista 90 - 2008)  
 Serial No. < MA020167179

**C**

77122700 (31004855)  
 1420925  
 77122600 (34003012)  
 77121900 OR 34044795 (n. 3 pz.)



**Cod. 77122300** - Grasso/Grease 36206780  
 (LOXEAL 4 silicónico al PTFE (Cod. art. 804004) tubo da 100g)

**2" CON - 100, 140, 150 Lit.**  
**Cod. CR0682780** (01322009)  
 (Serie N-Protagonista 90 - 2009)  
 Serial No. > MA020167013

**D**

77122700 (31004855)  
 1420925  
 77122600 (34003012)

**Cod. 77122400** - Grasso/Grease 36206760  
 (KLUBER Non Trop PLB DR (Cod. art. 572411) tubo da 100g)

 MARENO INDUSTRIE ALI spa Mareno di Piave (TV)	ELABORATO:	APPROVATO:	GRUPPO:	DENOMINAZIONE:		
			Serie 90	Rubinetti di scarico da 2"		
	DATA:	DATA:	PARTICOLARE:	REV. N.	DEL	DISEGNO N.
	15 Ott 2009	15 Ott 2009	Disegno esplosivo per ricambi 	Z00	0110	3.P.14/2
	SOST. DIS.					

MOD.

PI9-8G10 9251600



PI9-8G14 9251800

vsezip.ru

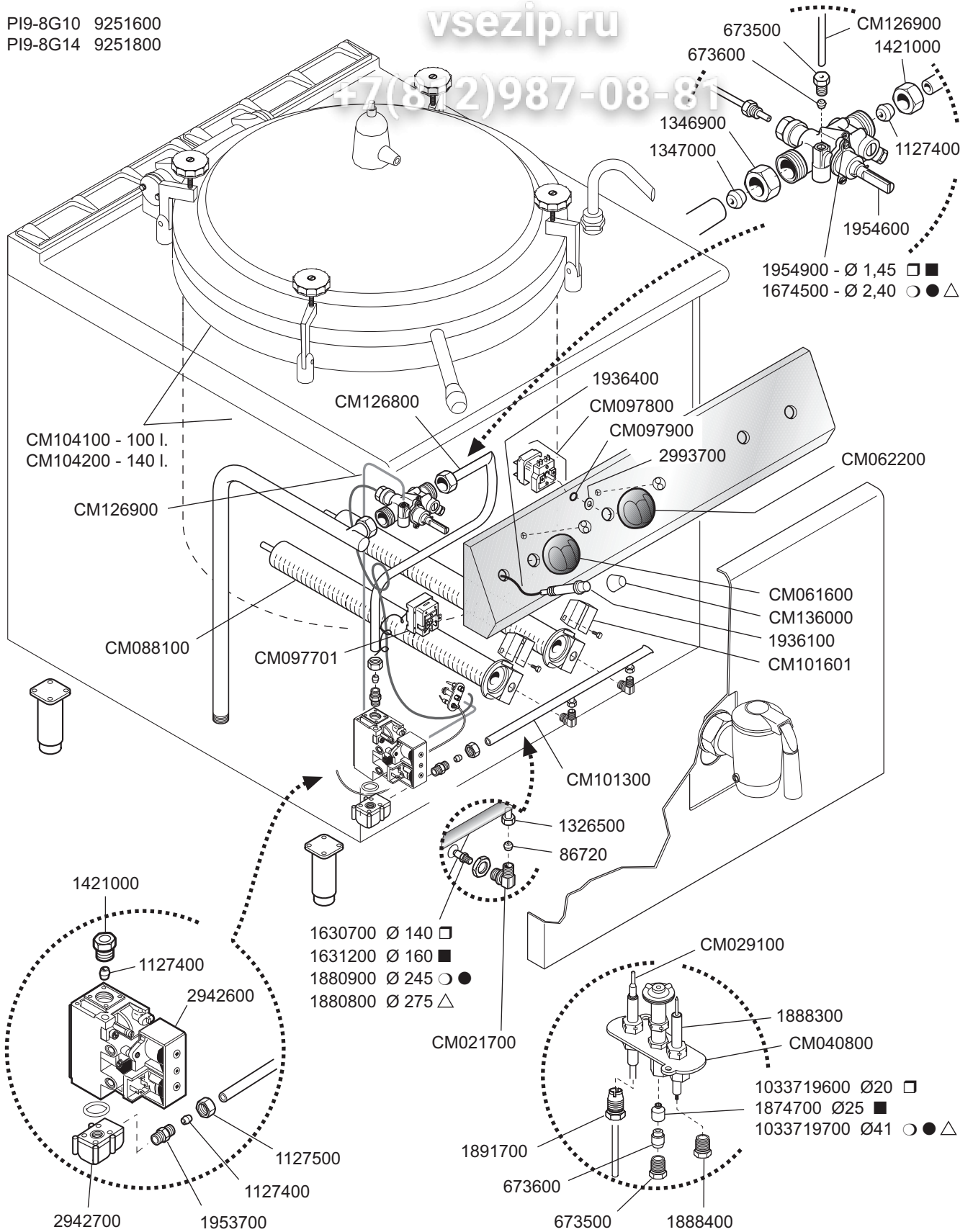
+7(812)987-08-81



□ G30/50 ■ G30/29 ○ G20/20 ● G25/25 △ G25/20 ▲ G110/8 ● G120/8 ● G140/8

 MARENO INDUSTRIE ALI spa Mareno di Piave (TV)	ELABORATO:	APPROVATO:	GRUPPO:	DENOMINAZIONE:		
			Serie 90	Impianto gas		
	DATA:	DATA:	PARTICOLARE:	REV. N.	DEL	DISEGNO N.
	10 Mar 1999	10 Mar 1999	Disegno esploso per ricambi	▼	▼	▼
SOST. DIS.	Z00.0806.3.P.26		CE	Z01	0909	3.P.26