



Зип Ощепит

vsezip.ru

Spare Parts for

+7(812)987-08781 **Combi Ovens**



Spare parts suitable for

**BOURGEOIS**

2017

Find the complete and up-to-date range of products in our GEV Webshop



## heating elements

## immersion heating elements

with compression flange 50 x 26mm

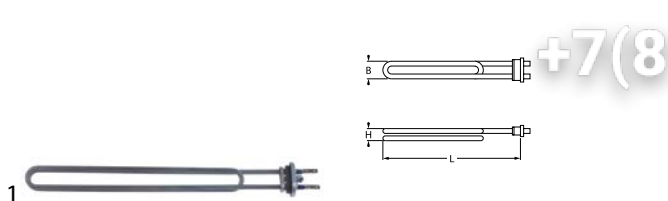

<b>GEV No.</b>	418932	<b>Ref. No.</b>	RC553
<b>description</b>	heating element 2000W 240V heating circuits 1 flange 50x26mm L 350mm W 30mm Hmm compression flange connection male faston 6.3mm tube ø 6.3mm immersion heater		

## miscellaneous



<b>GEV No.</b>	420200	<b>Ref. No.</b>	RC2035
<b>description</b>	heating element 12000W 240V heating circuits 6 L 155mm W 78mm H 83mm tube ø 8.4mm hole distance 61mm hole ø 7mm connection male faston 6.3mm immersion heater flange connection		



<b>GEV No.</b>	420203	<b>Ref. No.</b>	RC2029
<b>description</b>	heating element 12000W 240V heating circuits 6 L 165mm W 74mm H 83.5mm tube ø 8.4mm hole distance 61mm hole ø 7mm number of thermostat sleeves 1 thermostat sleeves ø 7.4mm length thermostat sleeves 73mm thermostat sleeve eccentric, clinging connection male faston 6.3mm immersion heater flange connection		

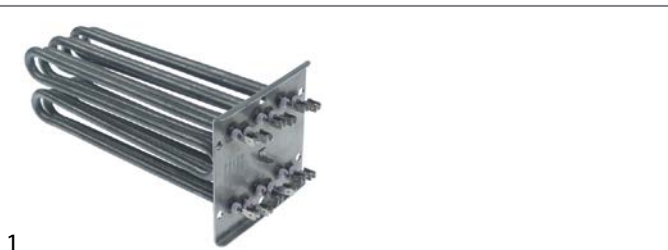

<b>GEV No.</b>	420202	<b>Ref. No.</b>	RC2034
<b>description</b>	heating element 18000W 240V heating circuits 6 L 229mm W 78mm H 83mm tube ø 8.4mm hole distance 61mm hole ø 7mm connection male faston 6.3mm immersion heater flange connection		

Зип Общепит

vsezip.ru

+7(812)987-08-81



<b>GEV No.</b>	420199	<b>Ref. No.</b>	RC2032
<b>description</b>	heating element 18000W 240V heating circuits 6 L 235mm W 78mm H 83mm tube ø 8.4mm hole distance 61mm hole ø 7mm connection male faston 6.3mm immersion heater flange connection		



<b>GEV No.</b>	416502	<b>Ref. No.</b>	RC231 RC802
<b>description</b>	heating element 8000W 240V heating circuits 3 L 305mm W 40mm Hmm number of thermostat sleeves thermostat sleeves ømm length thermostat sleevesmm tube ø 6.3mm hole distance 44.9mm hole ø 10mm connection length 23mm connection male faston 6.3mm 4 hole flange immersion heater flange width 63.5mm flange length 63.5mm ø 40mm		

<b>accessories for</b>	416502		
<b>GEV No.</b>	505180	<b>Ref. No.</b>	JOIN261
<b>description</b>	O-ring EPDM thickness 3.53mm ID ø 47.22mm Qty 1 pcs		



<b>GEV No.</b>	420201	<b>Ref. No.</b>	RC2033
<b>description</b>	heating element 9000W 240V heating circuits 6 L 135mm W 78mm H 83.5mm tube ø 8.4mm hole distance 61mm hole ø 7mm connection male faston 6.3mm immersion heater flange connection		

## heating elements for convection



<b>GEV No.</b>	418916	<b>Ref. No.</b>	RC018 RC048 RC17
<b>description</b>	heating element 12000W 240V heating circuits 3 ID ø 390mm ED ø 410mm L 410mm H 100mm H1 25mm H2 75mm thread M12x1 6 hole fixing connection male faston 6.3mm tube ø 8.5mm convection heating element		

<b>accessories for</b>	418916		
<b>GEV No.</b>	101566	<b>Ref. No.</b>	—
<b>description</b>	nut thread M12x1 H 10mm WS 19 SS Qty 1 pcs		



Table continues overleaf



Зип Общепит

vsezip.ru

+7(812)987-08-81

<b>accessories for</b>	418916		
	<b>GEV No.</b>	506046	<b>Ref. No.</b> —
	flat gasket FIBER ED ø 19.5mm ID ø 13mm thickness 2mm Qty 1 pcs		
	<b>GEV No.</b>	528622	<b>Ref. No.</b> —
	spring ø 15.3mm L 25mm wire gauge ø 1.25mm for water filling		

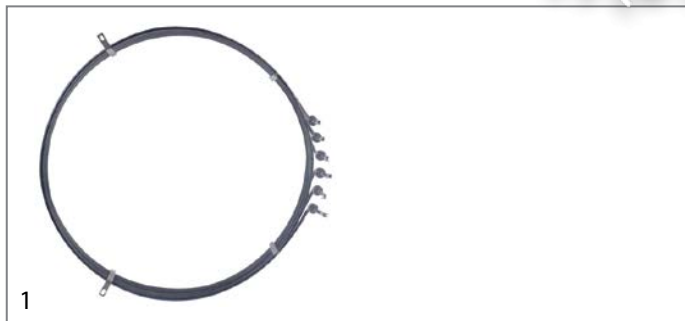



<b>GEV No.</b>	418927	<b>Ref. No.</b>	RC081
<b>description</b>	heating element 12000W 240V heating circuits 3 ID ø 440mm ED ø 458mm L 472mm H 80mm L1 15mm H1 8mm H2 72mm thread M12x1 6 hole fixing connection male faston 6.3mm tube ø 6.3mm convection oven convection heating element		

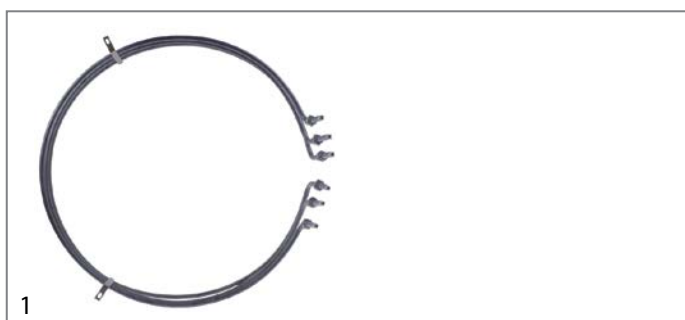

<b>GEV No.</b>	418926	<b>Ref. No.</b>	RC019
<b>description</b>	heating element 8000W 240V heating circuits 3 ID ø 301mm ED ø 317mm L 328mm H 95mm L1 11mm H1 12mm H2 83mm thread M12x1 6 hole fixing connection male faston 6.3mm tube ø 8.5mm convection oven convection heating element		



<b>GEV No.</b>	418928	<b>Ref. No.</b>	RC017 RC18
<b>description</b>	heating element 9000W 240V heating circuits 3 ID ø 458mm ED ø 475mm L 475mm H 114mm H1 31mm H2 73mm thread M12x1 6 hole fixing connection male faston 6.3mm tube ø 8.5mm convection oven convection heating element		

<b>accessories for</b>	418928		
	<b>GEV No.</b>	101566	<b>Ref. No.</b> —
	nut thread M12x1 H 10mm WS 19 SS Qty 1 pcs		
	<b>GEV No.</b>	506046	<b>Ref. No.</b> —
	flat gasket FIBER ED ø 19.5mm ID ø 13mm thickness 2mm Qty 1 pcs		
	<b>GEV No.</b>	528662	<b>Ref. No.</b> —
	flat gasket copper ED ø 16mm ID ø 12mm thickness 1.5mm		



<b>GEV No.</b>	418925	<b>Ref. No.</b>	RC611
<b>description</b>	heating element 1500W 230V heating circuits 1 L 293mm W 106mm L1 32mm L2 261mm W2 83mm flange length 50mm flange width 26mm connection length 63mm connection male faston 6.3mm tube ø 8.5mm hole ø 6.2mm W1 23mm convection heating element convection oven INCOLOY windings 2		

<b>accessories for</b>	418925		
	<b>GEV No.</b>	520588	<b>Ref. No.</b> JOIN071
	gasket L 46mm W 22mm hole distance 24.5mm silicone for heating element		



<b>GEV No.</b>	416500	<b>Ref. No.</b>	IR00612Y RC601
<b>description</b>	heating element 2000W 230V heating circuits 1 L 295mm W 110mm L1 35mm L2 260mm W2 88mm flange length 50mm flange width 26mm connection length 60mm connection male faston 6.3mm tube ø 8.5mm hole ø 6.2mm W1 15mm compression flange dry heating element		

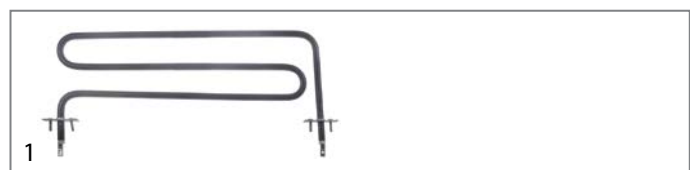

<b>GEV No.</b>	418933	<b>Ref. No.</b>	RC114 RC154
<b>description</b>	heating element 2000W 240V heating circuits 1 L 390mm W 134mm W2 100mm flange length 50mm flange width 20mm connection length 50mm connection M4 tube ø 10mm thread M4 W1 34mm rectangular flange convection heating element convection oven		

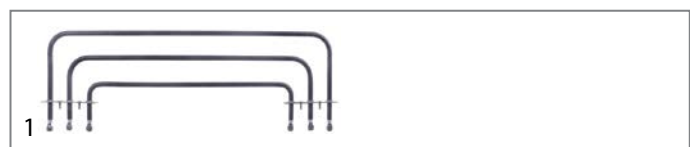

<b>GEV No.</b>	418917	<b>Ref. No.</b>	RC111 RC151
<b>description</b>	heating element 3000W 240V heating circuits 3 L 570mm W 140mm W2 110mm flange length 110mm flange width 20mm hole distance 40mm connection length 55mm connection M4 tube ø 10mm thread M4 W1 30mm rectangular flange convection heating element convection oven		



<b>GEV No.</b>	418918	<b>Ref. No.</b>	RC110 RC511
<b>description</b>	heating element 4000W 240V heating circuits 3 L 570mm W 140mm W2 110mm flange length 110mm flange width 20mm hole distance 40mm connection length 55mm connection M4 tube ø 10mm thread M4 W1 30mm rectangular flange convection heating element convection oven		



Зип.Общепит

thermostats

vsezip.ru

+7(812)987-08-81

## accessories

## sealing washers

## O-rings

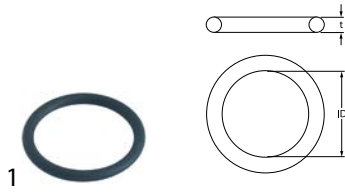

<b>GEV No.</b>	505092	<b>Ref. No.</b>	JOIN057
<b>description</b>	O-ring EPDM thickness 5.34mm ID ø 43.82mm Qty 1 pcs		

## flange gaskets



<b>GEV No.</b>	511688	<b>Ref. No.</b>	JOIN2033
<b>description</b>	gasket silicone L 115mm W 114mm thickness 4mm		



<b>GEV No.</b>	511687	<b>Ref. No.</b>	JOIN2029
<b>description</b>	gasket silicone L 138mm W 107mm thickness 4mm		



<b>GEV No.</b>	520588	<b>Ref. No.</b>	JOIN071
<b>description</b>	gasket L 46mm W 22mm hole distance 24.5mm silicone for heating element		

## control and safety thermostats

EGO

## control thermostats

55.10/19\_series

E·G·O



<b>GEV No.</b>	375002	<b>Ref. No.</b>	THER001
<b>description</b>	thermostat t.max. 320°C temperature range 55-320°C 1-pole 1NO 16A probe ø 3.1mm probe L 226mm capillary pipe 870mm capillary pipe isolated 850mm gland nut shaft L 23mm shaft position upper rotation 270°		

## 55.13\_series

E·G·O

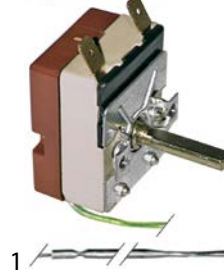

<b>GEV No.</b>	375154	<b>Ref. No.</b>	THER019
<b>description</b>	thermostat t.max. 250°C temperature range 50-250°C 1-pole 1NO 16A probe ø 3.1mm probe L 201mm capillary pipe 2970mm capillary pipe isolatedmm gland nut shaft L 23mm shaft position upper rotation 270° probe material SS		

## 55.34\_series

E·G·O



<b>GEV No.</b>	376051	<b>Ref. No.</b>	THER102
<b>description</b>	thermostat t.max. 200°C temperature range 70-145-200°C 3-pole 3NC probe ø 3.1mm probe L 263mm capillary pipe 880mm capillary pipe isolated 400mm		





3ип Общепит

vsezip.ru

+7(812)987-08-81

**IMIT / TEMPOMATIC / ARTHERMO**  
control thermostats

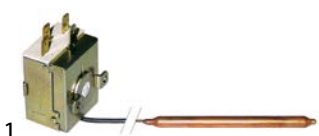

1

<b>GEV No.</b>	390186	<b>Ref. No.</b>	REGU010
<b>description</b>	thermostat t.max. 52°C temperature range fixed 52°C 1-pole 1CO 16A probe ø 6.5mm probe L 95mm capillary pipe 1000mm capillary pipe isolated 1000mm gland nut shaft Lmm contacts 1CO		

push/momentary push switches

ø12mm



1

<b>GEV No.</b>	347567	<b>Ref. No.</b>	INT003
<b>description</b>	momentary push switch mounting ø 12mm white 1NO 250V 4A connection male faston 6.3mm ambient temperature max. 85°C protection IP40		

**CAEM**  
safety thermostats



1

<b>GEV No.</b>	375996	<b>Ref. No.</b>	THER3004
<b>description</b>	safety thermostat switch-off temp. 225°C 1-pole 1NC 16A probe ø 5mm probe L 80mm capillary pipe 900mm capillary pipe isolated 410mm gland nut M10 probe SS 250V		

**microswitches**  
pin-plunger actuated

M12



1

<b>GEV No.</b>	345350	<b>Ref. No.</b>	INT008	
<b>description</b>	microswitch with plunger mounting distance 22mm thread M12x0.75 thread L 16mm 250V 16A 1CO connection male faston 6.3mm stroke 4mm ambient temperature max. 125°C type EF83161.3 actuating force: 66g			
<b>accessories for</b>	345350			
	<b>GEV No.</b>	345351	<b>Ref. No.</b>	—
	nut thread M12x0.75 H 1.6mm WS 14 chrome-plated brass Qty 1 pcs			

**switches and momentary switches**  
rocker/momentary rocker switches

30x22mm



1

<b>GEV No.</b>	301004	<b>Ref. No.</b>	INT006	
<b>description</b>	rocker switch mounting measurements 30x22mm black 2CO 250V 16A connection male faston 6.3mm ambient temperature max. 125/55°C protection IP40			
<b>accessories for</b>	301004			
	<b>GEV No.</b>	301036	<b>Ref. No.</b>	—
	protective cover internal size 30x22mm for rocker switch mounting measurementsmm			

**cam switches**  
4 operating positions



1

<b>GEV No.</b>	300077	<b>Ref. No.</b>	COMU004
<b>description</b>	cam switch 4 operating positions 5NO sequence 0-1-2-3 16A shaft ø 6x4.6mm shaft L 23mm connection male faston 6.3mm plastic		

**blank**



1

<b>GEV No.</b>	301165	<b>Ref. No.</b>	INT006	
<b>description</b>	rocker switch mounting measurements 30x22mm black 2CO 250V 16A connection male faston 6.3mm ambient temperature max. 125/55°C protection IP65 with cover cap			
<b>accessories for</b>	301165			
	<b>GEV No.</b>	301036	<b>Ref. No.</b>	—
	protective cover internal size 30x22mm for rocker switch mounting measurementsmm			



## magnetic switches

M12x1

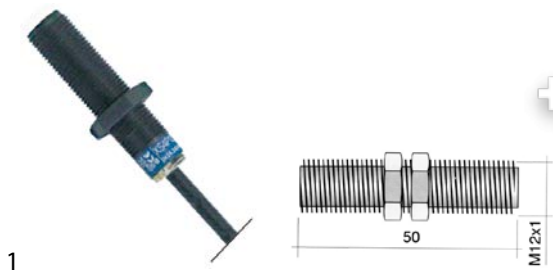

1

<b>GEV No.</b>	345900	<b>Ref. No.</b>	INT005
<b>description</b>	magnetic switch thread M12x1 1NO 24-240V AC/DCV 0.2A P max. 5-50W connection cable cable length 2000mm		

## control equipment

## SCHNEIDER ELECTRIC

## rotary switches



1

<b>GEV No.</b>	347951	<b>Ref. No.</b>	INT037
<b>description</b>	rotary selector mounting measurements $\varnothing$ 22mm green sequence 0-1 latching illuminated		

## TELEMECANIQUE (EFA)

## XB2 series

## signal element



1

<b>GEV No.</b>	345397	<b>Ref. No.</b>	VOY103
<b>description</b>	signal element mounting measurements $\varnothing$ 22mm red		

## rotary switches



1

<b>GEV No.</b>	345222	<b>Ref. No.</b>	INT202
<b>description</b>	rotary selector mounting measurements $\varnothing$ 22mm black latching sequence 0-1		

Зип Общепит

vsezip.ru

+7(812)987-08-81



1

<b>GEV No.</b>	345222	<b>Ref. No.</b>	INT205
<b>description</b>	rotary selector mounting measurements $\varnothing$ 22mm black latching sequence 1-0-2		

## ZB2 series

## switch blocks



1

<b>GEV No.</b>	347566	<b>Ref. No.</b>	INT036
<b>description</b>	contact block 2NO illuminated		

## ZB4 series

## rotary switches



1

<b>GEV No.</b>	347951	<b>Ref. No.</b>	INT037
<b>description</b>	rotary selector mounting measurements $\varnothing$ 22mm green sequence 0-1 latching illuminated		

## miscellaneous



1

<b>GEV No.</b>	345903	<b>Ref. No.</b>	INT204
<b>description</b>	push button black		

## lamps

## indicator lights

indicator lights 2-piece (lens and indicator lamp)

indicator light lenses

ø12mm (type SDY-3)



1

<b>GEV No.</b>	359261	<b>Ref. No.</b>	VOT060 VOY060
<b>description</b>	indicator light housings mounting measurements ø12mm red round Qty 1 pcs		

## indicator lights (complete)

ø13mm

with plug-in socket



1

<b>GEV No.</b>	359045	<b>Ref. No.</b>	VOY062
<b>description</b>	indicator light ø 13mm clear 230V connection male faston 6.3mm temp.-resist. 120°C Qty 1 pcs		



1

<b>GEV No.</b>	359141	<b>Ref. No.</b>	VOY060
<b>description</b>	indicator light ø 13mm red 230V connection male faston 6.3mm temp.-resist. 120°C Qty 1 pcs		

## screw-on/push-on fit

## halogen lamp

for socket G4 / G6.35 / G9



1

<b>GEV No.</b>	357193	<b>Ref. No.</b>	LAMP050
<b>description</b>	halogen lamp socket G4 12V 20W temp.-resist. 300°C OSRAM HALOSTAR OVEN		

## 3ип Общепит

oven lamps

## producer-specific oven lamps

BOURGEOIS



1

<b>GEV No.</b>	511690	<b>Ref. No.</b>	JOIN075 JOIN109
<b>description</b>	gasket L 78mm W 42mm silicone hole distance 66.5mm thickness 3mm for lamp		



1

<b>GEV No.</b>	360530	<b>Ref. No.</b>	HUBL009
<b>description</b>	lamp glass L 47.4mm W 32.8mm glas thickness 3.2mm		



1

<b>GEV No.</b>	359580	<b>Ref. No.</b>	LAMP011 Lamp012
<b>description</b>	lamp socket for halogen lamp		

## lamps

## halogen lamps

for socket G4 / G6.35 / G9



1

<b>GEV No.</b>	357193	<b>Ref. No.</b>	LAMP050
<b>description</b>	halogen lamp socket G4 12V 20W temp.-resist. 300°C OSRAM HALOSTAR OVEN		

## timers

## programme timers



1

<b>GEV No.</b>	360251	<b>Ref. No.</b>	05224C MOT010
<b>description</b>	gear motor CROUZET chambers 1 operation time 230V 50Hz shaft ømm shaft Lmm H 78mm L 116mm W 55mm type 88256462 shaft ø 5/6mm		



## mechanical timers

			
1			
<b>GEV No.</b>	350214	<b>Ref. No.</b>	MIN014
<b>description</b>	timer M2 2-pole operation time 120min impulse mechanical 1NO/1NC at 250V 16A permanent position no shaft ø 6x4.6mm shaft 6x4.6mm shaft L 23mm mounting distance 28mm connection lateral		

## power contactors

vsezip.ru

+7(812)987-08-81

			
1			
<b>GEV No.</b>	380479	<b>Ref. No.</b>	REL1607
<b>description</b>	power contactor resistive load 25A 230VAC (AC3/400V) 9A/4kW main contacts 3NO auxiliary contacts 1NO/1NC connection screw connection type LC1D09P7		

## alarm devices

## buzzers

			
1			
<b>GEV No.</b>	350050	<b>Ref. No.</b>	BRUI001
<b>description</b>	buzzer 230VAC connection male faston 6.3mm screw mounting thread M4 60dB		

			
1			
<b>GEV No.</b>	380976	<b>Ref. No.</b>	REL1600
<b>description</b>	power contactor resistive load 32A 230VAC (AC3/400V) 18A/7.5kW main contacts 3NO auxiliary contacts 1NO/1NC connection screw connection		

## contactors

## ISKRA (FANAL)

## power contactors

			
1			
<b>GEV No.</b>	380204	<b>Ref. No.</b>	REL610
<b>description</b>	power contactor resistive load 25A 230VAC (AC3/400V) 9A/4kW main contacts 3NO auxiliary contacts 1NO connection screw connection type Fanal DSL9 10 type ISKRA KNL9 10		

			
1			
<b>GEV No.</b>	380603	<b>Ref. No.</b>	REL611
<b>description</b>	power contactor resistive load 40A 230VAC (AC3/400V) 25A/11kW main contacts 4NO auxiliary contacts connection screw connection type LC1D25004		





Зип Общепит  
solid state relays

CROUZET  
vsezip.ru

+7(812)987-08-81



1

<b>GEV No.</b>	380982	<b>Ref. No.</b>	REL1603
<b>description</b>	power contactor resistive load 80A 230VAC (AC3/400V) 50A/22kW main contacts 3NO auxiliary contacts 1NO/1NC connection screw connection type LC1D50P7		



1

<b>GEV No.</b>	403090	<b>Ref. No.</b>	REL232
<b>description</b>	solid state relay CROUZET 1 phase 125A 48-660V 4-32VDC L 57mm W 44mm screw type 84134180		

auxiliary contactors



1

<b>GEV No.</b>	381139	<b>Ref. No.</b>	REL622
<b>description</b>	auxiliary contactor 230VAC AC1 10A type CA2KN407M7 connection male faston 2.8mm/6.3mm contacts 4NO		



1

<b>GEV No.</b>	403089	<b>Ref. No.</b>	REL231
<b>description</b>	solid state relay CROUZET 1 phase 50A 48-660V 4-32VDC L 57mm W 44mm screw type 84134120		

auxiliary contacts



1

<b>GEV No.</b>	381140	<b>Ref. No.</b>	REL464
<b>description</b>	auxiliary contact contacts 1NO/1NC AC15 6A connection screw type GVAN11		

electronics

PCBs



1

<b>GEV No.</b>	402984	<b>Ref. No.</b>	280901 ELEC2003 ELEC2017
<b>description</b>	control PCB combi-steamer UC0611/1011/2011 L 140mm W 100mm		

miscellaneous

installation contactors



1

<b>GEV No.</b>	380601	<b>Ref. No.</b>	REL153
<b>description</b>	contactor		



1

<b>GEV No.</b>	400802	<b>Ref. No.</b>	NIV010
<b>description</b>	level relay 240V type ATO 600722/A		

1 electric components



1

<b>GEV No.</b>	403685	<b>Ref. No.</b>	ELEC2001 ELEC2015
<b>description</b>	PCB L 200mm W 95mm		



1

<b>GEV No.</b>	361851	<b>Ref. No.</b>	ELEC014
<b>description</b>	PCB L 70mm W 20mm		



1

<b>GEV No.</b>	402982	<b>Ref. No.</b>	ELEC2004
<b>description</b>	relay PCB combi-steamer UC0611/1011/2011 cable length 220mm push-in		

## keypads

### keypad units



1

<b>GEV No.</b>	403122	<b>Ref. No.</b>	20467
<b>description</b>	keypad unit combi-steamer UC0611/1011/2011 buttons 9 L 350mm W 153mm		

Зип.Общепит

solenoid valves

vsezip.ru

### solenoid valves (water)

ROBERTS/FAW/INVENSYS



medium temperature: 90°C 90°C 60°C  
 ambient temperature: 60°C 25°C 60°C  
 duty cycle: 40% 100% 100%

### solenoid valves with reducers

#### 2-fold



1

<b>GEV No.</b>	370696	<b>Ref. No.</b>	ROB2000	
<b>description</b>	solenoid valve double straight 230VAC inlet 3/4" outlet 11.5mm t.max. 90°C Invensys plastic output A 1.2l/min flow regulating valve outlet A blue with non-return valve			
<b>spare parts for</b>	370696			
	<b>GEV No.</b>	371131	<b>Ref. No.</b>	—
	solenoid coil 230VAC			
	<b>GEV No.</b>	371174	<b>Ref. No.</b>	—
	solenoid coil 230VAC connection coded plug 6W			

### with coded terminal



1

<b>GEV No.</b>	370269	<b>Ref. No.</b>	06245
<b>description</b>	solenoid valve double straight 230VAC inlet 3/4" outlet 11.5mm DN10 EATON (INVENSYS)		

## electrodes



1

<b>GEV No.</b>	400807	<b>Ref. No.</b>	NIV007
<b>description</b>	level electrode 1/2" total length 112mm probe L 88mm insulated probe length uninsulatedmm connection bullet connector		



1

<b>GEV No.</b>	400804	<b>Ref. No.</b>	NIV602
<b>description</b>	level electrode 3/8" total length 75mm probe L 48mm insulated probe length 47mm conical connection M4		



Зип.Общепит

vsezip.ru

+7(812)987-08-81



fans

axial fans

import



1

<b>GEV No.</b>	601080 <sup>1</sup>	<b>Ref. No.</b>	MOT030
<b>description</b>	axial fan L 119mm W 119mm H 38mm 230VAC 50/60Hz 23/20W bearing ball bearing connection male faston 2.8mm metal ADDA fan wheel ø 110mm temp.-resist. 70°C		
<b>accessories for</b>	601080		
	<b>GEV No.</b>	550898	<b>Ref. No.</b> —
	connecting cable cable length 2000mm connection F 2.8 connection distance 7.9mm for axial flow fan		
	<b>GEV No.</b>	692519	<b>Ref. No.</b> —
	guard L 120mm W 120mm plastic		

<sup>1</sup>with ball bearings

hot air fans

ebm-papst



1

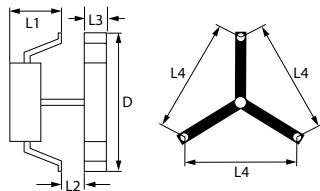

<b>GEV No.</b>	601808	<b>Ref. No.</b>	MOT2023
<b>description</b>	hot air fan 230/240V 50W L1 69mm L2mm L3mm L4 87mm fan wheel ø 150mm type RRL152/0020A92-3030LH-197 ebm-papst		

gear motors

for overalls



1

<b>GEV No.</b>	500811	<b>Ref. No.</b>	MOT018
<b>description</b>	gear motor AUTOM type ASR/30/FR 230V 50Hz shaft ø 8mm L 150mm W 65mm H 90mm		

pumps

drain pumps

HANNING



1

<b>GEV No.</b>	500573	<b>Ref. No.</b>	ROB013
<b>description</b>	drain pump 30W 4-piece 230V inlet ø 24/30mm outlet ø 24mm 50Hz HANNING type DPS25-032 1x pump, 3x pump cover		

service kits



1

<b>GEV No.</b>	500573	<b>Ref. No.</b>	ROB013
<b>description</b>	drain pump 30W 4-piece 230V inlet ø 24/30mm outlet ø 24mm 50Hz HANNING type DPS25-032 1x pump, 3x pump cover		

electric components



Зип.Общепит

fuses  
vsezip.ru

+7(812)987-08-81

booster pumps II

accessories



1	<b>GEV No.</b>	365017	<b>Ref. No.</b>	MOT2013
<b>description</b> operating capacitor capacity 5µF 450V tolerance 5% 50/60Hz ambient temperature max. -25 to +85°C ø 28mm L 54mm M8 plastic connection male faston 6.3mm 16.10.08 protection				

vibration pumps



1	<b>GEV No.</b>	500219	<b>Ref. No.</b>	POMP001
<b>description</b> vibration pump type CP.3A.958.1/ST 230V 65W 50Hz inlet ø 6 outlet ø 1/8" IT EATON (INVENSYS) L 123mm				

condensators & interference suppression filters

operating capacitors

plastic



1	<b>GEV No.</b>	365150	<b>Ref. No.</b>	MOT2008
<b>description</b> operating capacitor capacity 20µF 425V tolerance 5% 50Hz ambient temperature max. -25 to +85°C ø 40mm L 70mm M8 plastic connection male faston 6.3mm 416.10.25 protection				



1	<b>GEV No.</b>	365017	<b>Ref. No.</b>	MOT2013
<b>description</b> operating capacitor capacity 5µF 450V tolerance 5% 50/60Hz ambient temperature max. -25 to +85°C ø 28mm L 54mm M8 plastic connection male faston 6.3mm 16.10.08 protection				

fine fuses



1	<b>GEV No.</b>	358532	<b>Ref. No.</b>	FUSI003
<b>description</b> fine fuse size ø5x20mm 2A fast-acting rated 250V Qty 10 pcs				



1	<b>GEV No.</b>	358607	<b>Ref. No.</b>	Fusi004
<b>description</b> fine fuse size ø5x20mm 6.3A slow-acting rated 250V Qty 10 pcs				

electric accessories

terminals

terminal blocks



1	<b>GEV No.</b>	550232	<b>Ref. No.</b>	BAR001
<b>description</b> lustre terminal 12-pole cross section 2.5mm <sup>2</sup> max. 32A max 450V temp.-resist. 150°C				

rail-mounted terminals

WIELAND

rail-mounted terminals type 9700A



1	<b>GEV No.</b>	550374	<b>Ref. No.</b>	BORN101
<b>description</b> rail-mounted terminal WIELAND type 9700A/10 S35 1.5-16mm <sup>2</sup> top-hat rail 35mm blue W 10mm L 49mm				



Зип Общепит

vsezip.ru

+7(812)987-08-81



1

<b>GEV No.</b>	550375	<b>Ref. No.</b>	BORN102A
<b>description</b>	rail-mounted terminal WIELAND type 9700A/10 SL2 S35 1.5-16mm <sup>2</sup> top-hat rail 35mm yellow/green W 10mm L 53mm		



1

<b>GEV No.</b>	550377	<b>Ref. No.</b>	BORN105
<b>description</b>	rail-mounted terminal WIELAND type 9700A/16 S35 2.5-35mm <sup>2</sup> top-hat rail 35mm blue W 16mm L 59mm		



1

<b>GEV No.</b>	550378	<b>Ref. No.</b>	BORN108
<b>description</b>	rail-mounted terminal WIELAND type 9700A/16 SL2 S35 2.5-35mm <sup>2</sup> top-hat rail 35mm yellow/green W 16mm L 53mm		

accessories



1

<b>GEV No.</b>	550370	<b>Ref. No.</b>	BORN211
<b>description</b>	terminal block end bracket clampsmm <sup>2</sup>		

## ignition parts

### electrodes



1

<b>GEV No.</b>	106928	<b>Ref. No.</b>	ALLU009
<b>description</b>	ignition electrode flange length 22mm flange width 1 16mm D1 ø 7mm L1 4mm BL1 49mm BL2 20mm connection ø 6mm		

ignition units



1

<b>GEV No.</b>	106925	<b>Ref. No.</b>	ALLU030
<b>description</b>	ignition unit outputs 1 230VAC dimensions 85x63x38mm mounting distance 60mm inlet F2.8x0.8 outlet ø4mm type EBI4 1P S service kit 90VA 50-60Hz		

doors



1

<b>GEV No.</b>	694536	<b>Ref. No.</b>	DECO214
<b>description</b>	door bolt for combi-steamer thread M5 ø 8mm L 46mm		



1

<b>GEV No.</b>	696417	<b>Ref. No.</b>	DECO364
<b>description</b>	locking screw for door thread M5		



1

<b>GEV No.</b>	696418	<b>Ref. No.</b>	DECO043
<b>description</b>	locking screw for door thread M5		



1

<b>GEV No.</b>	696419	<b>Ref. No.</b>	JOIN655
<b>description</b>	rubber sleeve for door		



1

<b>GEV No.</b>	696421	<b>Ref. No.</b>	DECO414
<b>description</b>	threaded bush for door thread M5 IT ø 9.5mm L 24mm		

1 electric components





Зип.Общепит

LOCKS  
vsezip.ru

+7(812)987-08-81



<b>GEV No.</b>	696422	<b>Ref. No.</b>	DECO384
<b>description</b>	threaded bush for door thread M5 L 48mm		

door mechanics

accessories



<b>GEV No.</b>	694537	<b>Ref. No.</b>	CHAR203
<b>description</b>	base plate L 51mm W 22mm for catch plastic mounting distance 30mm thickness 2mm		

handle latches  
universal  
inside fixing  
locks



<b>GEV No.</b>	694054	<b>Ref. No.</b>	CHAR2006
<b>description</b>	door handle for headed units L 145mm W 40mm H 62mm spring length 33mm inner black		

<b>spare parts for</b>	694054			
	<b>GEV No.</b>	514390	<b>Ref. No.</b>	—
	spring for door handle ø 6mm L 54mm W 27.5mm			

	<b>GEV No.</b>	694675	<b>Ref. No.</b>	—
	door catch L 88mm W 40mm H 37mm spring length 33mm mounting distance 60mm			

	<b>GEV No.</b>	694734	<b>Ref. No.</b>	—
	door handle L 165mm W 40mm H 25mm black			

	<b>GEV No.</b>	694735	<b>Ref. No.</b>	—
	cap ø 32mm black			

<b>accessories for</b>	694054			
	<b>GEV No.</b>	691123	<b>Ref. No.</b>	—
	duct for door opener			

	<b>GEV No.</b>	694055	<b>Ref. No.</b>	—
	door catch L 25mm W 14mm total length 54mm thread M8 thread L 29mm			

	<b>GEV No.</b>	694066	<b>Ref. No.</b>	—
	door catch with spigot 2-stage L 28mm W 14mm H 15mm H1 16mm total length 51mm thread M8 thread L 23mm stainless steel			

	<b>GEV No.</b>	694067	<b>Ref. No.</b>	CHAR2007
	door catch with spigot 1-stage L 26mm total length 51mm thread M8			

knobs

universal knobs



<b>GEV No.</b>	110865	<b>Ref. No.</b>	MAN130
<b>description</b>	knob switch zero mark t.max.°C ø 50mm shaft ø 6x4.6mm shaft flat left black		



<b>GEV No.</b>	110253	<b>Ref. No.</b>	MAN003
<b>description</b>	knob switch zero mark t.max.°C ø 50mm shaft ø 6x4.6mm shaft flat upper black		

<b>accessories for</b>	110253			
	<b>GEV No.</b>	550965	<b>Ref. No.</b>	—
	knob spring ø 6x4.6mm Qty 1 pcs			

producer-specific knobs

BOURGEOIS



<b>GEV No.</b>	110865	<b>Ref. No.</b>	MAN130
<b>description</b>	knob switch zero mark t.max.°C ø 50mm shaft ø 6x4.6mm shaft flat left black		

mechanical components, equipment accessories





Зип Общепит  
edge mount latches

push button latches  
vsezip.ru

6186 PRESTO series  
+7(812)987-08-81

producer-specific

**BOURGOIS**

 <p>1</p>			
<b>GEV No.</b>	694054	<b>Ref. No.</b>	CHAR2006
<b>description</b>	door handle for headed units L 145mm W 40mm H 62mm spring length 33mm inner black		
<b>spare parts for</b>	694054		
	<b>GEV No.</b>	514390	<b>Ref. No.</b> —
	spring for door handle ø 6mm L 54mm W 27.5mm		
	<b>GEV No.</b>	694675	<b>Ref. No.</b> —
	door catch L 88mm W 40mm H 37mm spring length 33mm mounting distance 60mm		
	<b>GEV No.</b>	694734	<b>Ref. No.</b> —
	door handle L 165mm W 40mm H 25mm black		
	<b>GEV No.</b>	694735	<b>Ref. No.</b> —
	cap ø 32mm black		
<b>accessories for</b>	694054		
	<b>GEV No.</b>	691123	<b>Ref. No.</b> —
	duct for door opener		
	<b>GEV No.</b>	694055	<b>Ref. No.</b> —
	door catch L 25mm W 14mm total length 54mm thread M8 thread L 29mm		
	<b>GEV No.</b>	694066	<b>Ref. No.</b> —
	door catch with spigot 2-stage L 28mm W 14mm H 15mm H1 16mm total length 51mm thread M8 thread L 23mm stainless steel		
	<b>GEV No.</b>	694067	<b>Ref. No.</b> CHAR2007
	door catch with spigot 1-stage L 26mm total length 51mm thread M8		

push button latches

6186 PRESTO series

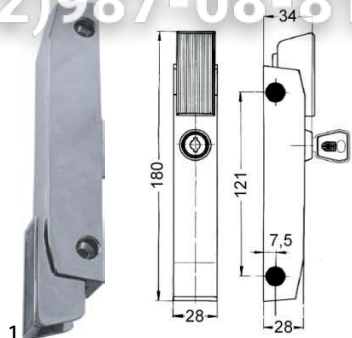

<b>GEV No.</b>	701042	<b>Ref. No.</b>	90000012 MB90000012
<b>description</b>	push button latch L 180mm mounting distance 121mm chrome-plated H 34mm W 28mm type PRESTO no. 6186		

snap locks

universal



<b>GEV No.</b>	700800	<b>Ref. No.</b>	CHAR150
<b>description</b>	snap lock L 59mm W 11.5mm H 15mm mounting distance 50mm complete with door catch nickel-plated brass thickness 2.7mm		

miscellaneous



<b>GEV No.</b>	511618	<b>Ref. No.</b>	00461A
<b>description</b>	door catch H 24.5mm L 31mm W 21mm mounting distance 21mm roller ø 14mm		



<b>GEV No.</b>	511619	<b>Ref. No.</b>	02668B
<b>description</b>	door catch with roller H 23mm adjustable L 90mm W 21mm mounting distance 52/76mm roller ø 14mm		

mechanical components, equipment accessories

Зип.Общепит

gaskets  
vsezip.ru

+7(812)987-08-81

hinges

door bearing



1

<b>GEV No.</b>	511603	<b>Ref. No.</b>	COUS002
<b>description</b>	bush H 7.5mm ID $\varnothing$ 8.2mm with layer		



1

<b>GEV No.</b>	690835	<b>Ref. No.</b>	CHAR202
<b>description</b>	hinge bearing without bolt		

miscellaneous



1

<b>GEV No.</b>	511602	<b>Ref. No.</b>	CHAR201
<b>description</b>	hinge		

accessories

bushes



1

<b>GEV No.</b>	694336	<b>Ref. No.</b>	DECO 071
<b>description</b>	bush ID $\varnothing$ 8mm ED $\varnothing$ 12mm L 15mm		

gaskets for heated units

Window seals

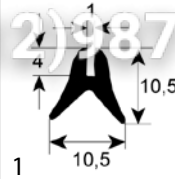

1

<b>GEV No.</b>	901512	<b>Ref. No.</b>	JOIN063
<b>description</b>	window gasket profile 1615 L 1350mm suitable for BOURGEOIS Qty 1		

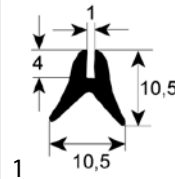

1

<b>GEV No.</b>	511610	<b>Ref. No.</b>	JOIN066
<b>description</b>	window gasket profile 1615 L 1950mm Qty 1		

door seals

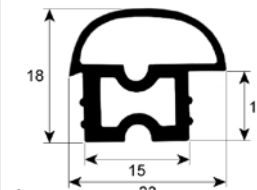

1

<b>GEV No.</b>	901411	<b>Ref. No.</b>	10683A MB10683A
<b>description</b>	door seal profile 2035 Qty supplied by meter		

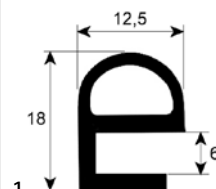

1

<b>GEV No.</b>	901516	<b>Ref. No.</b>	JOIN082 KITJOIN082
<b>description</b>	door seal profile 2225 perimeter 2030mm suitable for BOURGEOIS		

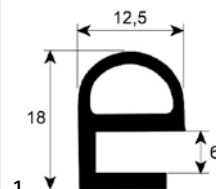

1

<b>GEV No.</b>	901409	<b>Ref. No.</b>	JOIN018
<b>description</b>	door seal profile 2225 perimeter 2530mm suitable for BOURGEOIS		

mechanical components, equipment accessories



Зип Общепит

vsezip.ru

+7(812)987-08-81

<b>GEV No.</b>	901427	<b>Ref. No.</b>	KITJOIN018
<b>description</b>	door seal profile 2225 perimeter 2530mm suitable for BOURGEOIS		

<b>GEV No.</b>	901424	<b>Ref. No.</b>	JOIN021 JOIN022 PROF777
<b>description</b>	door seal profile 2711 L 2600mm Qty 1		

<b>GEV No.</b>	901410	<b>Ref. No.</b>	JOIN019 KITJOIN019
<b>description</b>	door seal profile 2225 perimeter 3900mm suitable for BOURGEOIS Qty 1		

<b>GEV No.</b>	901655	<b>Ref. No.</b>	JOIN015
<b>description</b>	door seal profile 2980 L 2230mm		

<b>GEV No.</b>	901425	<b>Ref. No.</b>	JOIN1003
<b>description</b>	door seal profile 2226 L 3500mm Qty 1 W 700mm		

<b>GEV No.</b>	518126	<b>Ref. No.</b>	JOIN016 PROF1612
<b>description</b>	door seal profile 2980 L 2820mm		

<b>GEV No.</b>	901426	<b>Ref. No.</b>	JOIN155 JOIN180
<b>description</b>	door seal profile 2226 perimeter 2250mm Qty 1		

<b>GEV No.</b>	511620	<b>Ref. No.</b>	JOIN029
<b>description</b>	door seal profile 2985 L 4350mm Qty 1		

**gaskets for control panels**

<b>GEV No.</b>	901514	<b>Ref. No.</b>	JOIN1015
<b>description</b>	door seal profile 2227 perimeter 2650mm suitable for BOURGEOIS kit		

<b>GEV No.</b>	901510	<b>Ref. No.</b>	JOIN086
<b>description</b>	gasket for control panel W 13mm L 1500mm suitable for BOURGEOIS		

<b>GEV No.</b>	901508	<b>Ref. No.</b>	JOIN087
<b>description</b>	gasket for control panel W 13mm L 2050mm suitable for BOURGEOIS		

mechanical components, equipment accessories

Зип Общежит  
sealing washers

silicone gaskets  
vsezip.ru

+7(812)987-08-81

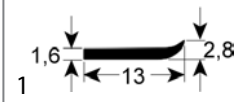

<b>GEV No.</b>	901509	<b>Ref. No.</b>	JOIN088
<b>description</b>	gasket for control panel W 13mm L 3500mm suitable for BOURGEOIS		

O-rings

EPDM

ø1.78mm

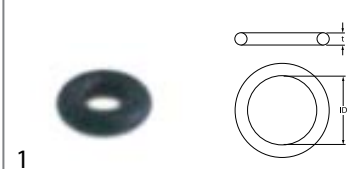

<b>GEV No.</b>	524421	<b>Ref. No.</b>	JOIN211
<b>description</b>	O-ring EPDM thickness 1.78mm ID ø 2.78mm Qty 1 pcs		

ø3.53mm

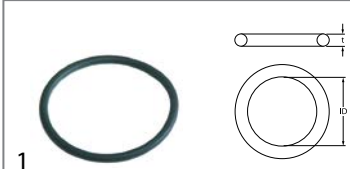

<b>GEV No.</b>	505180	<b>Ref. No.</b>	JOIN261
<b>description</b>	O-ring EPDM thickness 3.53mm ID ø 47.22mm Qty 1 pcs		

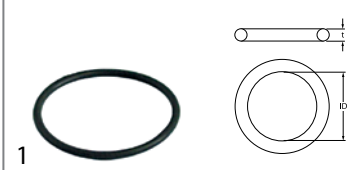

<b>GEV No.</b>	511331	<b>Ref. No.</b>	JOIN 261
<b>description</b>	O-ring EPDM thickness 3.53mm ID ø 53.57mm Qty 1 pcs		

ø5.34mm

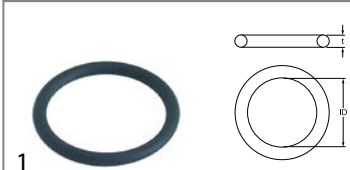

<b>GEV No.</b>	505092	<b>Ref. No.</b>	JOIN057
<b>description</b>	O-ring EPDM thickness 5.34mm ID ø 43.82mm Qty 1 pcs		

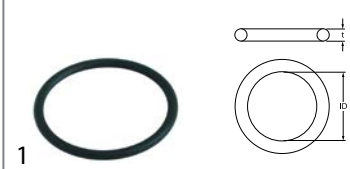

<b>GEV No.</b>	691033	<b>Ref. No.</b>	JOIN057
<b>description</b>	O-ring EPDM thickness 5.34mm ID ø 62.87mm Qty 1 pcs		

<b>GEV No.</b>	511691	<b>Ref. No.</b>	JOIN047
<b>description</b>	gasket silicone ED ø 51mm ID ø 4mm thickness 2mm Qty 1 pcs for combi-steamer		

special gaskets

miscellaneous



<b>GEV No.</b>	511615	<b>Ref. No.</b>	JOIN660
<b>description</b>	boiler gasket		



<b>GEV No.</b>	511600	<b>Ref. No.</b>	00288A JOIN084
<b>description</b>	gasket ED ø 80mm		



<b>GEV No.</b>	511689	<b>Ref. No.</b>	JOIN2026
<b>description</b>	gasket for lamp L 100mm W 24mm silicone thickness 2.8mm hole distance 22mm		





springs

compression springs



1

<b>GEV No.</b>	692202	<b>Ref. No.</b>	RES028
<b>description</b>	compression spring ø 4mm L 3mm wire gauge ø 0.5mm windings 2		

water cycle components

pressure reduction valves

pressure reduction valves

producer-specific



1

<b>GEV No.</b>	520589	<b>Ref. No.</b>	ROB028
<b>description</b>	pressure reduction valve Norgren series R91 connection 1/4" default settingbar setting range 0.1-3bar p max 10bar t.max. 50°C brass		



1

<b>GEV No.</b>	520553	<b>Ref. No.</b>	ROB2004
<b>description</b>	pressure reduction valve Norgren series R91 connection 3/4" default settingbar setting range 0.1-3bar p max 10bar t.max. 50°C with manometer and non-return valve brass		

fastening material

screws

grub screws

DIN 913/ISO 4026



1

<b>GEV No.</b>	504733	<b>Ref. No.</b>	VIS317
<b>description</b>	grub screw thread M4 L 5mm stainless steel DIN 913 intake internal hexagon WS 2 Qty 1 pcs		

miscellaneous



1

<b>GEV No.</b>	692200	<b>Ref. No.</b>	DECO366
<b>description</b>	grub screw thread M6 L 2.5mm SS intake slotted WS Qty 1 pcs		

washers

washers

miscellaneous



1

<b>GEV No.</b>	692198	<b>Ref. No.</b>	VIS276
<b>description</b>	plain washer ID ø 8.5mm ED ø 18mm thickness 1.4mm SS Qty 1 pcs		



consumables

sealants and adhesives

high temperature silicone



1	<b>GEV No.</b>	890059	<b>Ref. No.</b>	JOIN555
	<b>description</b>	high temperature silicone FERMITOPP 300 neutral curing -40 up to +265°C black cartridge 310ml		
	<b>description</b>	<p>Fermitopp HN 300 - cartridge 310ml - black                  Is used for sealing expansion joints on heating flues, ovens, reactors, chimneys, stacks, etc. The sealant is neutrally cross-linking, reacts with the moisture in the air and is characterised by extremely good hot air-resistance. The adhesive surfaces must be dry, clean and free of loose parts and in the case of porous substrates they should, if necessary, be given a first coat of primer. Post-smoothing e.g. with soap solution must take place before skinning.                  Highly refractory, odourless, UV/water/colour/hot-air resistant                  Temperature range -50°C to +250°C</p>		

Зип-Общепит

fine fuses



1	<b>GEV No.</b>	358532	<b>Ref. No.</b>	FUSi003
	<b>description</b>	fine fuse size ø5x20mm 2A fast-acting rated 250V Qty 10 pcs		



1	<b>GEV No.</b>	358607	<b>Ref. No.</b>	FUSi004
	<b>description</b>	fine fuse size ø5x20mm 6.3A slow-acting rated 250V Qty 10 pcs		

tools, fastening materials, consumables

Зип Общепит

vsezip.ru

+7(812)987-08-81

<b>A</b>		<b>M</b>	
alarm devices	8	magnetic switches	6
axial fans	11	mechanical timers	8
<b>B</b>		microswitches	5
booster pumps II	12	motors	11
<b>C</b>		<b>O</b>	
cam switches	5	operating capacitors	12
condensators & interference suppression filters	12	O-rings	18
consumables	20	oven lamps	7
contactors	8	<b>P</b>	
control equipment	6	pressure reduction valves	19, 19
control thermostats	4, 5	programme timers	7
<b>D</b>		pumps	11
door seals	16	push button latches	15
drain pumps	11	push/momentary push switches	5
<b>E</b>		<b>R</b>	
edgemount latches	15	rocker/momentary rocker switches	5
electric accessories	12	<b>S</b>	
electrodes	10	screws	19
<b>F</b>		sealants and adhesives	20
fans	11	sealing washers	18
fastening material	19	silicone	20
fine fuses	20	snap locks	15
fuses	12, 20	solenoid valves	10
<b>G</b>		solid state relays	9
gaskets for control panels	17	switches and momentary switches	5
gaskets for heated units	16	<b>T</b>	
grub screws	19	terminals	12
<b>H</b>		thermostats	4
halogen lamp	7	timers	7
heating elements	2	<b>V</b>	
heating elements for convection	2	vibration pumps	12
high temperature silicone	20	<b>W</b>	
hot air fans	11	washers	19
<b>I</b>		water cycle components	19
ignition units	13	window seals	16
immersion heating elements	2		
indicator lights	7		
indicator lights (complete)	7		
<b>L</b>			
lamps	7		