

3ип Общежит  
RICAMBI - SPARE PARTS - PIECES DETACHEES  
vsezip.ru

+7(812)987-08-81

LAVASTOVIGLIE

DISHWASHERS

LAVE VAISSELLES

4Q82 - 4Q82ECO

J50 - J500

N50 - N500

4 K50



LAVASTOVIGLIE - DISHWASHERS - LAVE VAISSELLE - GESCHIRRSPUELER - LAVAPLATOS



Зип Общепит

vsezip.ru

+7(812)987-08-81

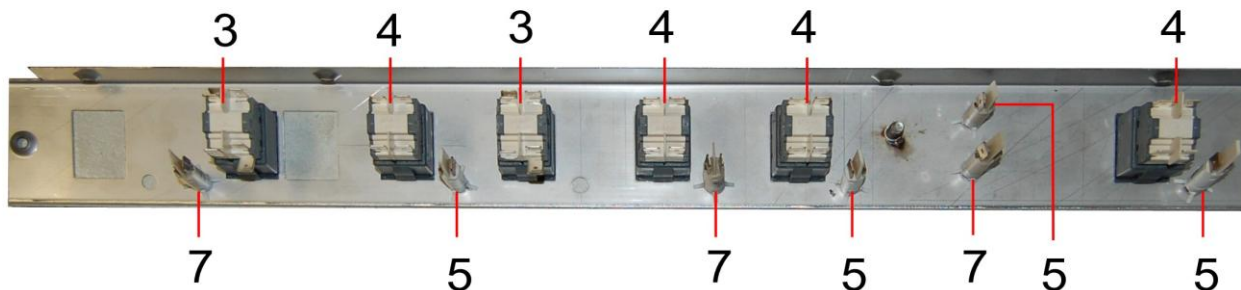
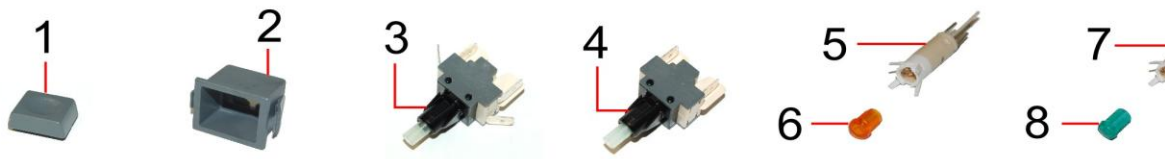

Pos.	Codice	Descrizione	Description	De
1	CETRP2230GR	Tasto grigio	Grey button	Button gris
2	CETP2230GR	Telaio porta tasto grigio	Mounting for grey button	Support button fix
3	CEDPPFD	Deviatore bipolare	Inner switch, latched	Selecteur bipolaire
4	CEPBPF	Pulsante bipolare	Inner push button momentary	Bouton bipolaire
5	CESPA6	Lampada arancio 6mm	Lamp assy, 6mm, orange	Ampoule orange, 6
6	CEGA6	Gemma arancio 6mm	Lens, orange, 6mm	Voyant orange, 6m
7	CESPV6	Lampada verde 6mm	Lamp assy, 6mm, green	Ampoule verte, 6m
8	CEGV6	Gemma verde 6mm	Lens, green, 6mm	Voyant vert, 6mm
9	GMPI5CF	Portainterruttori inox	Steel inner control panel	Porte-interrupteur i
9A	GMPI5CF08	Portainterruttori inox (2008)	Steel inner control panel (2008)	Porte-interrupteur i



Зип Общепит  
vsezip.ru

+7(812)987-08-81

Pos.	Codice	Descrizione	Description	Des
1	CETP25G01	Tasto tondo grigio "0-1"	On/off button, round, grey	Bouton rond gris "0
2	CEGV6	Gemma verde 6mm	Lens, green, 6mm	Voyant vert, 6mm
3	CETP25GPC	Tasto tondo grigio "partenza ciclo"	Cycle start button, round, grey	Bouton rond gris "d
4	CEGA6	Gemma arancio 6mm	Lens, orange, 6mm	Voyant orange, 6m
5	CETP25GLV	Tasto tondo grigio "lento veloce"	Cycle selector button, round, grey	Bouton rond gris "le
6	CETP6GR	Tappo spia grigio 6mm	Cap, warning light, grey	Bouchon gris, 6mm
7	CETP25GRF	Tasto tondo grigio "risciacquo freddo"	Cold rinse button, round, grey	Bouton rond gris "ri
8	CETP25GRR	Tasto tondo grigio "rigenerazione"	Re-set button, round, grey	Bouton rond gris "r
9	CETP25GPS	Tasto tondo grigio "pompa scarico"	Drain pump button, round, grey	Bouton rond gris "p
10	CETP25GRRS	Tasto tondo grigio "resistenze"	Heater indicator button, round, grey	Bouton rond gris "r
11	CETP25SF	Supporto tasto fisso	Support for indicator button	Support bouton fix
12	CETP25GR	Tasto tondo grigio "tappo"	Button, round, grey (cap)	Bouton rond gris "E
13	CEPC5D25RGR	Pannello comandi vasca raggiata	Control panel, plastic, grey	Panneau de contro
13A	CEPC5D25QGR	Pannello comandi vasca quadra	Control panel, plastic, grey	Panneau de contro
13B	CEPC5D25DPGR	Pannello comandi vasca doppia parete	Control panel, plastic, grey, double skin	Panneau de controle,

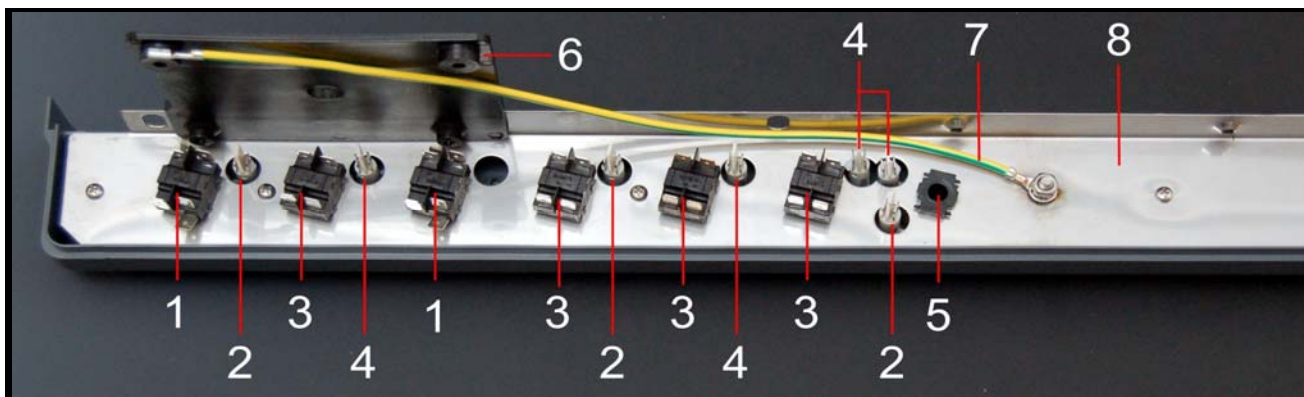

Pos.	Codice	Descrizione	Description	Des
1	CEDPPFD	Deviatore bipolare	Inner switch bipolar	Deviateur bipolaire
2	CESPV6	Lampada verde 6mm	Lamp assy, green, 6mm	Ampoule vert, 6mm
3	CEPBPFD	Pulsante bipolare	Inner push botton bipolar	Bouton bipolaire
4	CESPA6	Lampada arancio 6mm	Lamp assy, orange, 6mm	Ampoule orange, 6
5	CETP25SF	Supporto tasto fisso	Support for indicator button	Support bouton fix
6	CEPPPC	Piastra prolunga pannello comandi	Extension for component tray	Rallonge plaque co
7	CECBCTTC	Catenaria circuito terra "TC"	Catenary, loom, ground	Cable de circuit à la
8	CEPC5D25RGR	Parte interruttori inpu	Steel inner control panel	Parte interrupteur

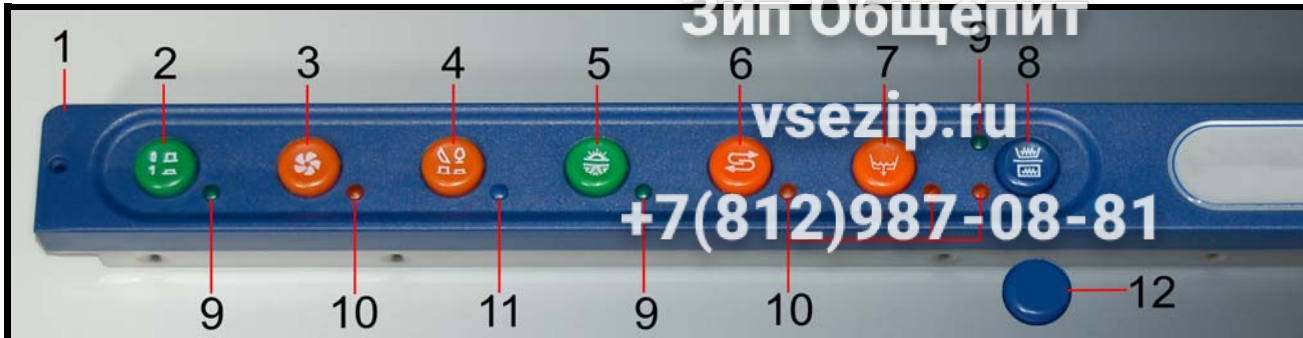

Pos.	Codice	Descrizione	Description	De
1	CEPC5D25	Pannello comandi blu	Control panel, plastic, blue	Panneau de contro
2	CETP25V01	Tasto tondo verde "0-1"	On/off button, round, green	Bouton rond vert "0
3	CETP25APC	Tasto tondo arancio "partenza ciclo"	Cycle start button, round, orange	Bouton rond orang
4	CETP25ALV	Tasto tondo arancio "lento-veloce"	Cycle selector button, round, orange	Bouton rond orang
5	CETP25VRF	Tasto tondo verde "risciacquo freddo"	Cold rinse button, round, green	Bouton rond vert rin
6	CETP25AR	Tasto tondo arancio "rigenerazione"	Re-set button, round, orange	Bouton rond orang
7	CETP25APS	Tasto tondo arancio "pompa scarico"	Drain button, round, orange	Bouton orange pom
8	CETP25BR	Tasto tondo blu "resistenze"	Heater indicator button, round, blue	Bouton rond bleu re
9	CEGV6	Gemma verde dm. 6mm	Lens, green, dm. 6mm	Voyant vert, dm. 6
10	CEGA6	Gemma arancio dm. 6mm	Lens, orange, dm. 6mm	Voyant jaune, dm.
11	CETP6B	Tappo foro spia blu dm. 6mm	Cap, warning light, blue, dm. 6mm	Bouchon bleu, dm.
12	CETP25B	Tasto tondo blu "tappo"	Button, round, blue (cap)	Bouton rond bleu "

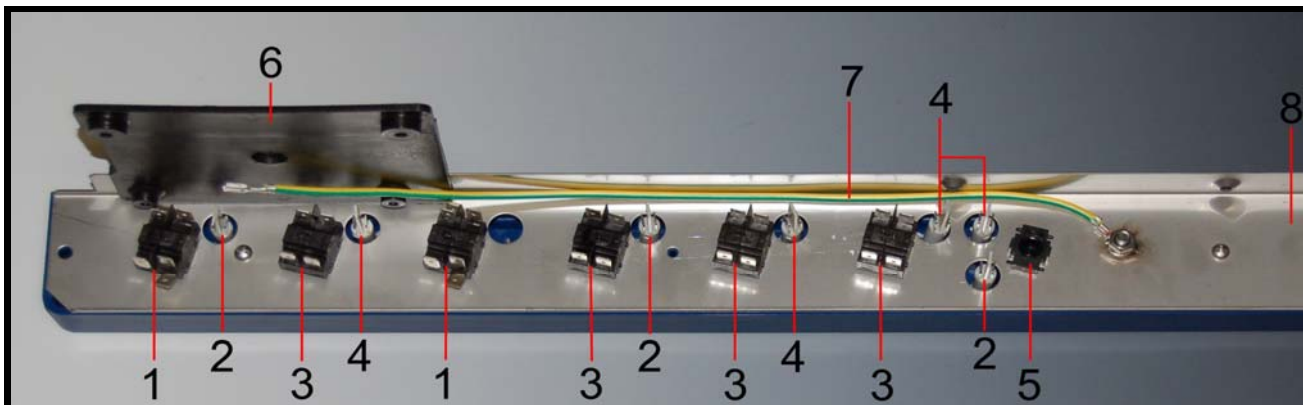

Pos.	Codice	Descrizione	Description	De
1	CEDPPFD	Deviatore bipolare	Latched push switch	Deviateur bipolaire
2	CESPV6	Lampada verde dm. 6mm	Lamp, green, dm. 6mm	Ampoule vert, dm.
3	CEPBPF	Pulsante bipolare	Momentary push switch	Bouton bipolaire
4	CESPA6	Lampada arancio dm. 6mm	Lamp, orange, dm. 6mm	Ampoule orange, d
5	CETP25SF	Supporto tasto fisso	Support for blanking button	Support bouton fix
6	CEPPPC	Piastra prolunga pannello comandi	Extension plate	Rallonge plaque co
7	CECBCTTC	Catenaria circuito terra	Earth cable	Cable de circuit à l
8	GMPI5NOS	Portainterruttori inox	Steel control panel	Porte-interrupteur i

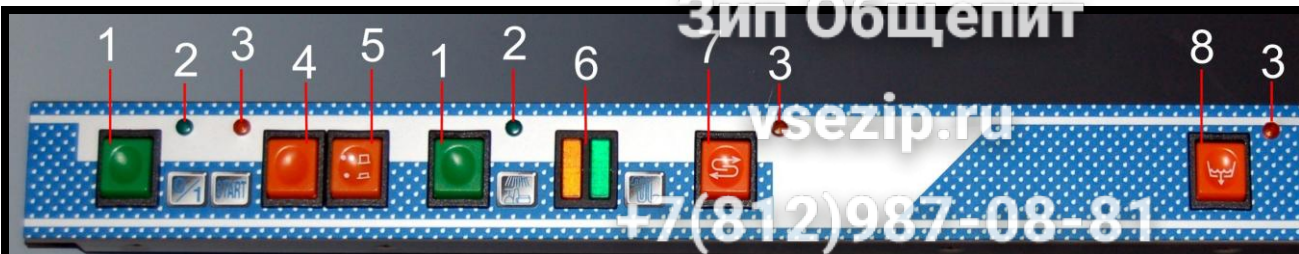

Pos.	Codice	Descrizione	Description	De
1	CETRP2230V	Tasto verde	Push botton green	Bouton poussoir ve
2	CEGV6	Gemma verde 6mm	Lens green, 6mm	Voyant vert, 6mm
3	CEGA6	Gemma arancio 6mm	Lens orange, 6mm	Voyant jaune, 6mm
4	CETRP2230A	Tasto arancio	Push botton orange	Bouton poussoir , c
5	CETRP2230ALV	Tasto arancio ciclo "lento veloce"	Speed selector orange button	Bouton poussoir , c
6	CESDAV	Spia doppia arancio verde	Double warning light, orange/green	Double voyant, ora
7	CETRP2230AR	Tasto arancio "rigenerazione"	Push botton orange "water softner"	Bouton poussoir , c
8	CETRP2230APS	Tasto arancio "pompa scarico"	Push button orange "drain pump"	Bouton poussoir , oran

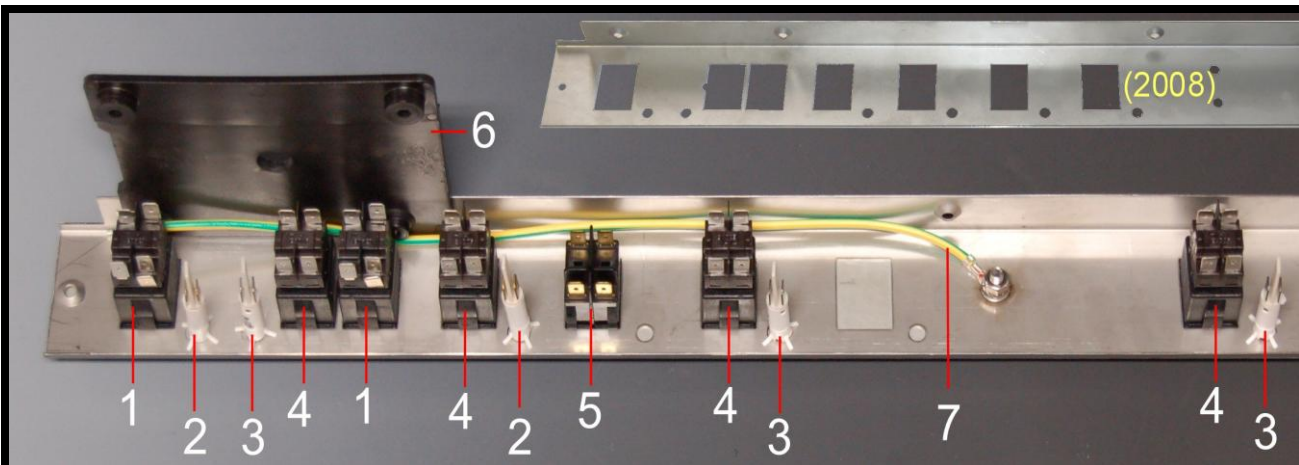

Pos.	Codice	Descrizione	Description	De
1	CEDPPFDCOMP	Deviatore + telaio completo	Inner switch body complete	Selecteur bipolaire
2	CESPV6	Lampada verde 6mm	Lamp assy, green, 6mm	Ampoule verte, dia
3	CESPA6	Lampada arancio 6mm	Lamp assy, orange, 6mm	Ampoule orange, d
4	CEBPFDCOMP	Pulsante + telaio completo	Inner push button body complete	Bouton bipolaire cc
5	CESDAV	Spia doppia arancio verde	Double warning light	Double voyant, ora
6	CEPPPC	Piastra prolunga pannello comandi	Extension for component tray	Rallonge plaque co
7	CECBCTTC	Catenaria circuito terra "TC"	Catenary loom ground	Cable de circuit à la
8	GMPI5CF	Portainterruttori inox	Steel inner control panel	Porte-interrupteur i
8A	GMPI5CF08	Portainterruttori inox (2008)	Steel inner control panel (2008)	Porte-interrupteur i



Pos.	Codice	Descrizione	Description	De
1	CETRP2230V	Tasto verde	Push botton, green	Bouton vert
2	CEGV6	Gemma verde 6mm	Lens green, 6mm	Voyant vert, 6mm
3	CEGA6	Gemma arancio 6mm	Lens orange, 6mm	Voyant jaune, 6mm
4	CETRP2230A	Tasto arancio	Push botton, orange	Bouton orange
5	CETRP2230ALV	Tasto arancio ciclo "lento veloce"	Speed selector button	Bouton orange "len
6	CESDAV	Spia doppia arancio verde	Double warning light, orange/green	Double voyant, ora
7	CETRP2230APS	Tasto arancio "pompa scarico"	Push button "drain pump", orange	Bouton orange, "po

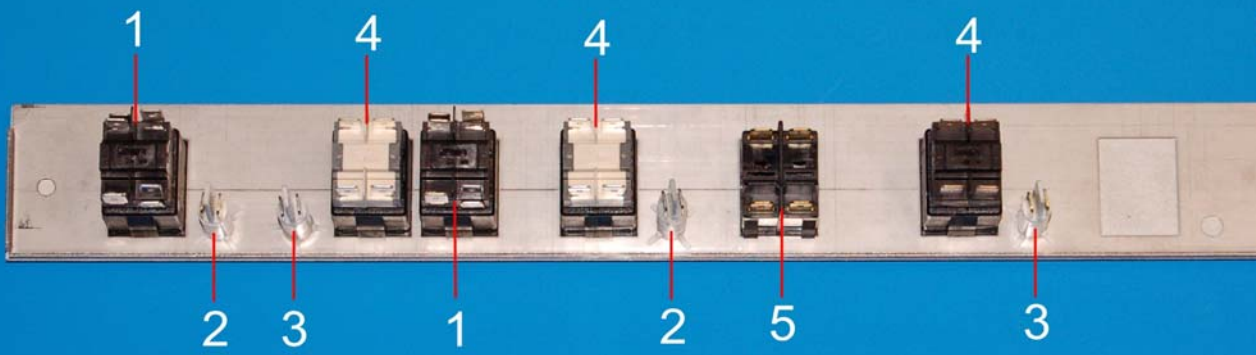

Pos.	Codice	Descrizione	Description	De
1	CEDPPFDCOMP	Deviatore + telaio completo	Inner switch body, latched	Selecteur bipolaire
2	CESPV6	Lampada verde 6mm	Lamp assy 6mm, green	Ampoule verte, 6m
3	CESPA6	Lampada arancio 6mm	Lamp assy 6mm, orange	Ampoule orange, 6
4	CEBPFDCOMP	Pulsante + telaio completo	Inner switch body, momentary	Bouton bipolaire cc
5	CESDAV	Spia doppia arancio verde	Double warning light, orange/green	Double voyant, ora
6	GMPI4QC	Portainterruttori inox	Steel inner control panel	Porte-interrupteur i

Зип Общепит

vsezip.ru

+7(812)987-08-81

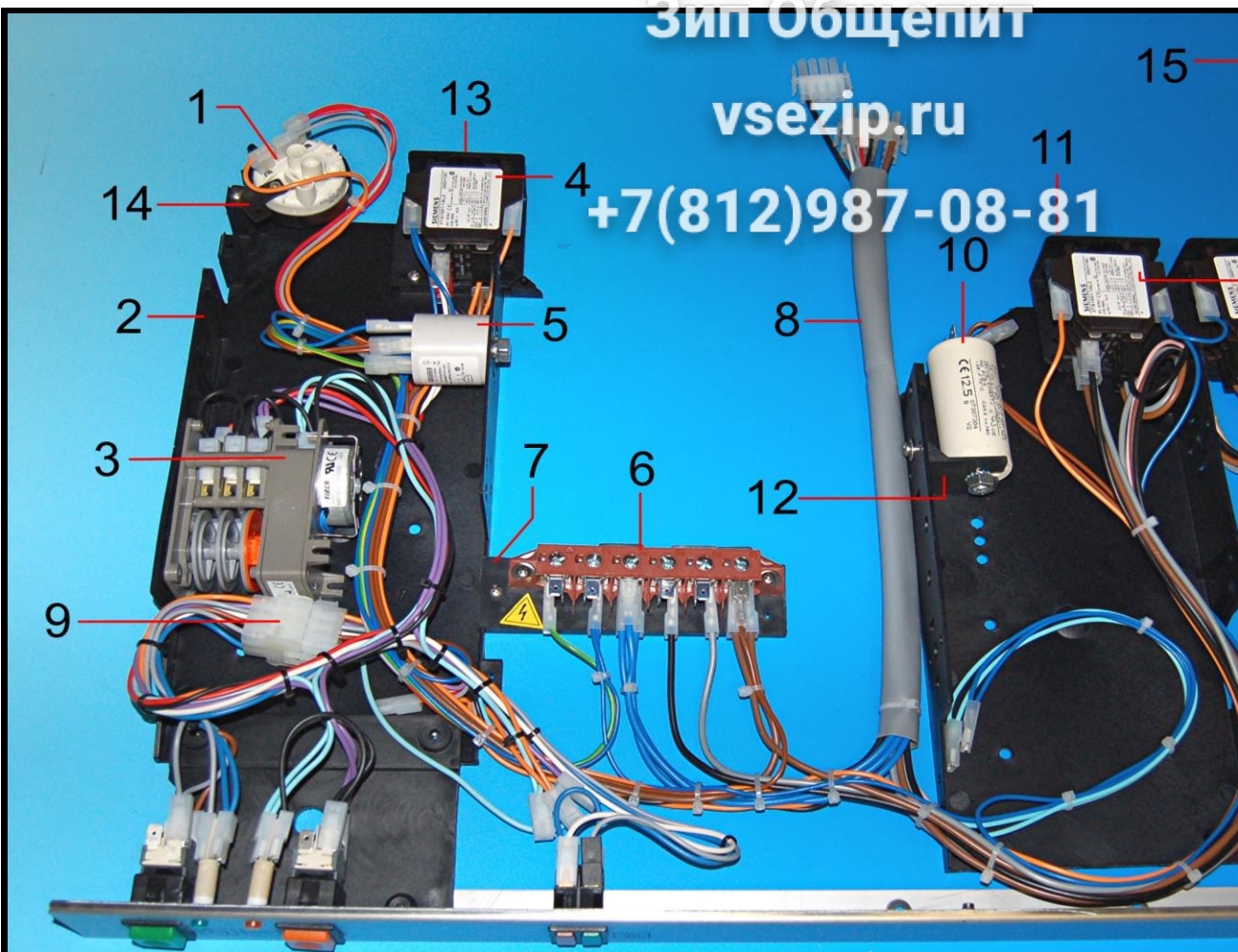

Pos.	Codice	Descrizione	Description	De
1	CEPRE	Pressostato 1 livello	Pressure switch	Pressostat, 1 nivea
2	CEPCE	Piastra cablaggio	Component tray	Plaque composant
3	CETF12B	Timer	Timer	Timer
4	CECTF	Teleruttore	4-p contactor	Contacteur
5	CEFA	Filtro antidisturbo	Suppressor	Filtre antiparasites
6	CEM0S3F	Morsettiera trifase	Main terminal block, 6-way	Bornier 3 phase
7	CEPFM	Piastrina fissaggio morsettiera	Mounting plate for terminal block	Plaquette fixage bo
8	CECBSR482AS	Cablaggio superiore	Upper loom	Cablage superieur
9	CECBPC1V4	Cablaggio pannello comandi	Control panel wiring loom	Cablage panneau c
10	CECN12	Condensatore 12,5 mf	Capacitor 12,5 mf	Condensateur 12,5
11	AM05SQTL2	Piastrina fissaggio 2 teleruttori	Double contactor bracket	Plaquette contacte
12	AM05SQFC	Piastrina fissaggio condensatore	Capacitor bracket	Plaquette condens
13	AM05SQTL1	Piastrina fissaggio 1 teleruttore	Contacteur bracket	Plaquette contacte
14	AM0SQPR	Piastra pressostato	Bracket for pressure switch	Plaque support pre
15	CECBI482	Cablaggio inferiore	Lower loom	Cablage inférieur



Зип Общепит

vsezip.ru

+7(812)987-08-81

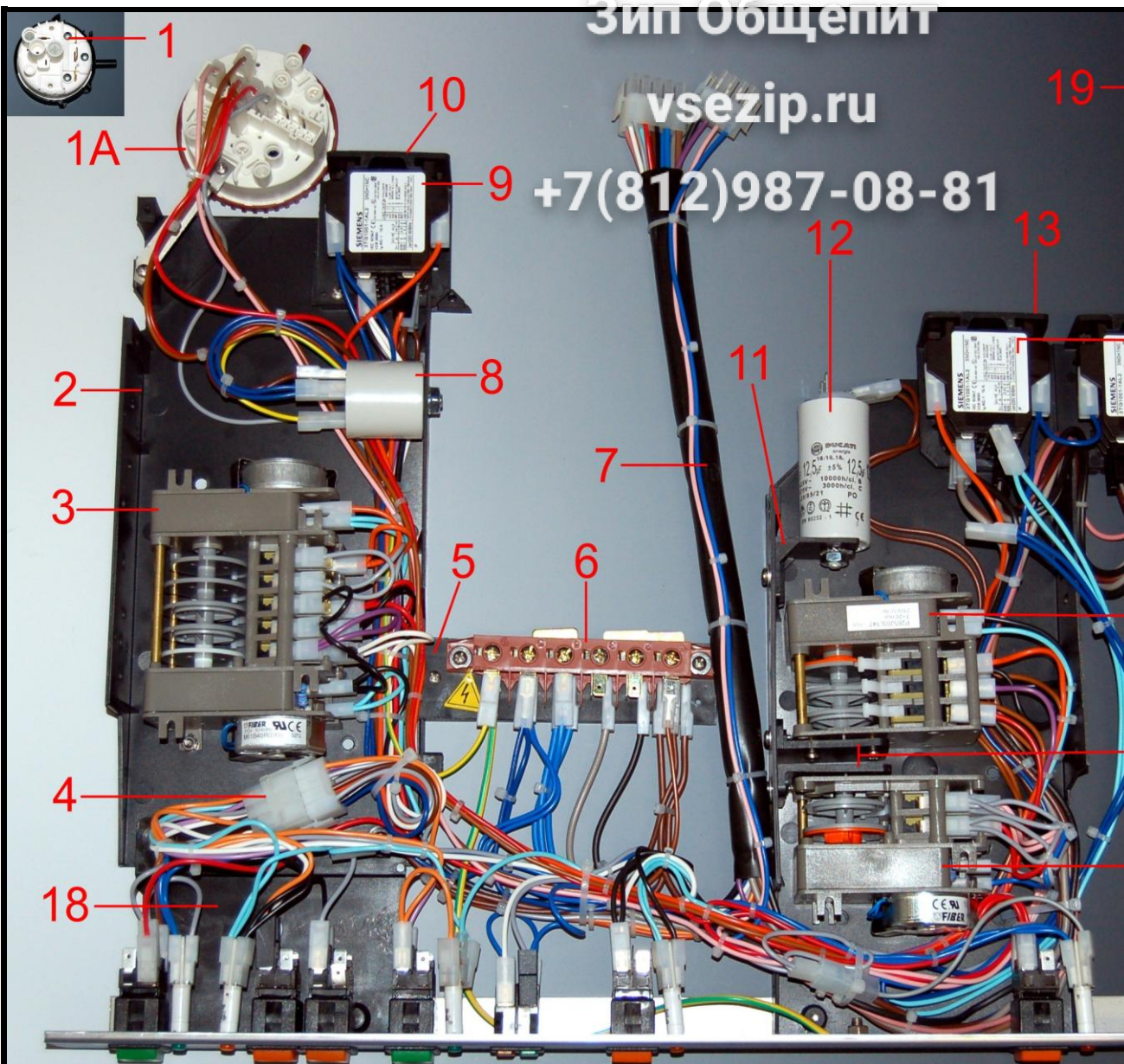

Pos.	Codice	Descrizione	Description	De
1	CEPRE	Pressostato 1 livello	Pressure switch	Pressostat, 1 nivea
1A	CEPRE2LUL	Pressostato 2 livelli	Double air pressure switch	Pressostat, 2 nivea
2	CEPCE	Piastra cablaggio	Component tray	Plaque composants
3	CETD1224BGB	Timer ciclo doppio	Timer, two cycles	Timer, double cycle
4	CECBCP2V4	Cablaggio pannello comandi	Control panel wiring loom	Cablage panneau c
5	CEPFM	Piastrina fissaggio morsetti	Mounting plate for terminal block	Plaquette fixation bo
6	CEMOS3F	Morsetti trifase	Main terminal block, 6-way	Bornier 3 phase
7	CECBS2T482	Cablaggio superiore	Upper loom	Cablage superieur
8	CEFA	Filtro antidisturbo	Suppressor	Filtre antiparasites
9	CECTF	Teleruttore	4-p contactor	Contacteur
10	AM05SQT1	Piastrina fissaggio 1 teleruttore	Contacteur bracket	Plaquette contacteur
11	AM05SQFC	Piastrina fissaggio condensatore	Capacitor bracket	Plaquette condens
12	CECN12	Condensatore 12,5 mf	Capacitor 12,5 mf	Condensateur 12,5
13	AM05SQT2	Piastrina fissaggio 2 teleruttori	Double contactor bracket	Plaquette contacteur
14	CETR20B	Timer rigenerazione	Salt re-generation timer	Timer régénération
15	CEPFTSIM	Piastrina fissaggio timer	Timer mounting bracket	Plaquette fixation tim

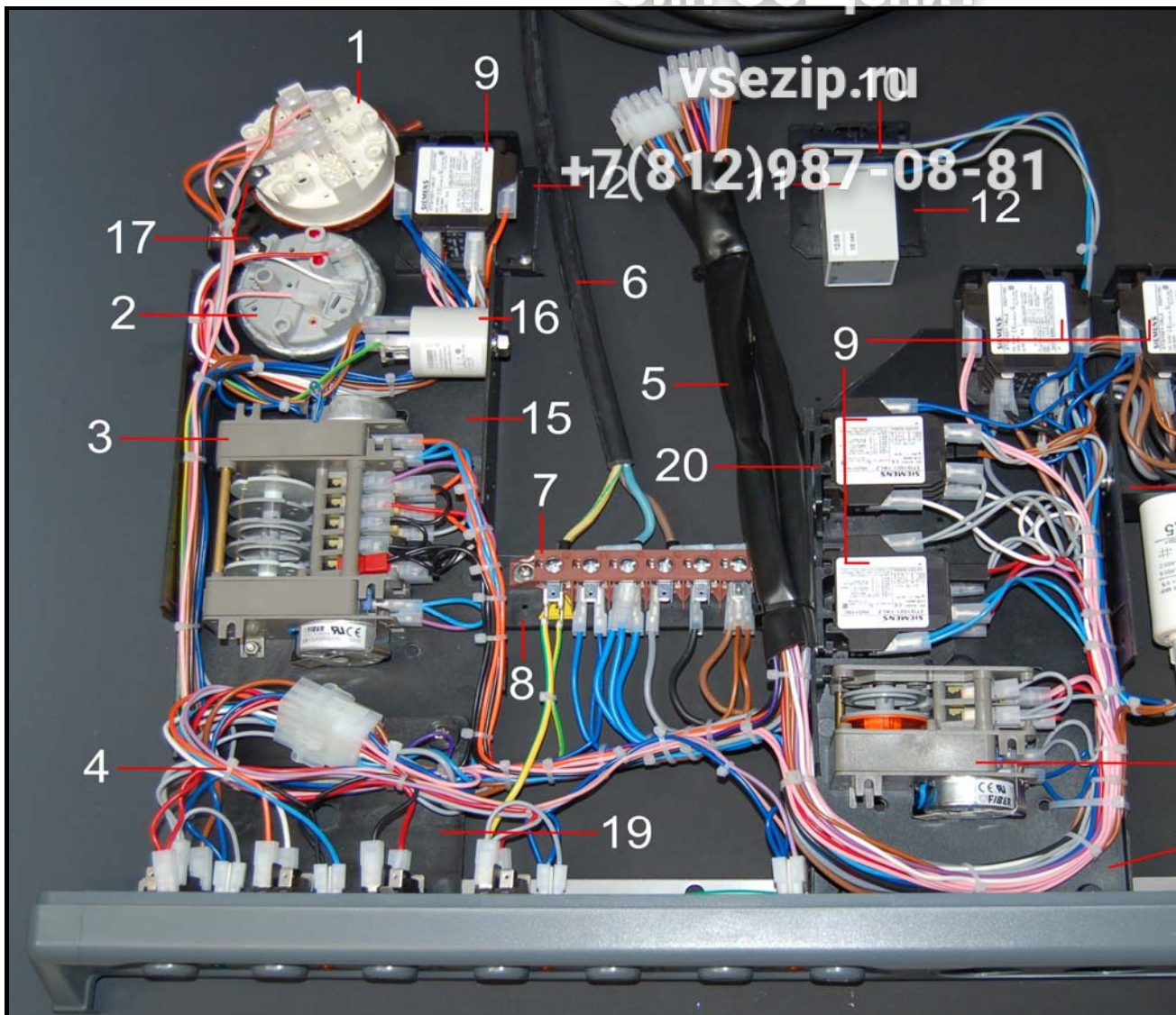

Pos.	Codice	Descrizione	Description	De
1	CEPRE2LUL	Pressostato 2 livelli "ETL"	Double pressure switch	Pressostat 2 niveau
2	CEPR62P	Pressostato 1 livello	Pressure switch, 30/90	Pressostat 1 niveau
3	CETD1224BGB	Timer ciclo doppio	Timer, 2-min & 4-min, ABS version	Timer double cycle
4	CECBPC2V4GBABPS	Cablaggio pannello comandi	Control panel wiring loom, ABS version	Cablage panneau c
5	CECBS2T482GBABPS	Cablaggio piastra	Upper loom, ABS version	Cable 2 timer-2V
6	CECE3536	Cavo alimentazione monofase	Main supply cable 3x6mm	Cable alimentation
7	CEM0S3F	Morsetiera trifase	Main terminal block, 6-way	Bornier
8	CEPFM	Piastra fissaggio morsetiera	Extension plate for terminal block	Plaquette fixation b
9	CECTF	Contattore 220v	4-pole contactor	Contacteur
10	CETF60A	Zoccolo octal a vite ritardatore	Base for Delay timer	Socle temporisateu
11	CETF024	Ritardatore air break	Delay timer	Temporisateur ABS
12	AM05SQTL1	Piastrina per 1 teleruttore	Bracket for delay timer	Plaquette contacteur
13	CECN12	Condensatore 12,5 mf	Capacitor 12.5 mi-F	Condensateur 12,5
14	CEPSTFB	Timer pompa scarico timer 180" 220V	Drain timer, 180" 220V	Timer cycle de vi
15	CEPCE	Piastra cablaggio elettrico	Component tray, no components	Plaque composants
16	CEFA	Filtro antidisturbo	Suppressor	Filtre électrique
17	AM0SQPR	Piastra pressostato	Bracket for pressure switch	Plaque support pre
18	AM05SQFC	Piastrina condensatore	Bracket for capacitor	Plaquette condens

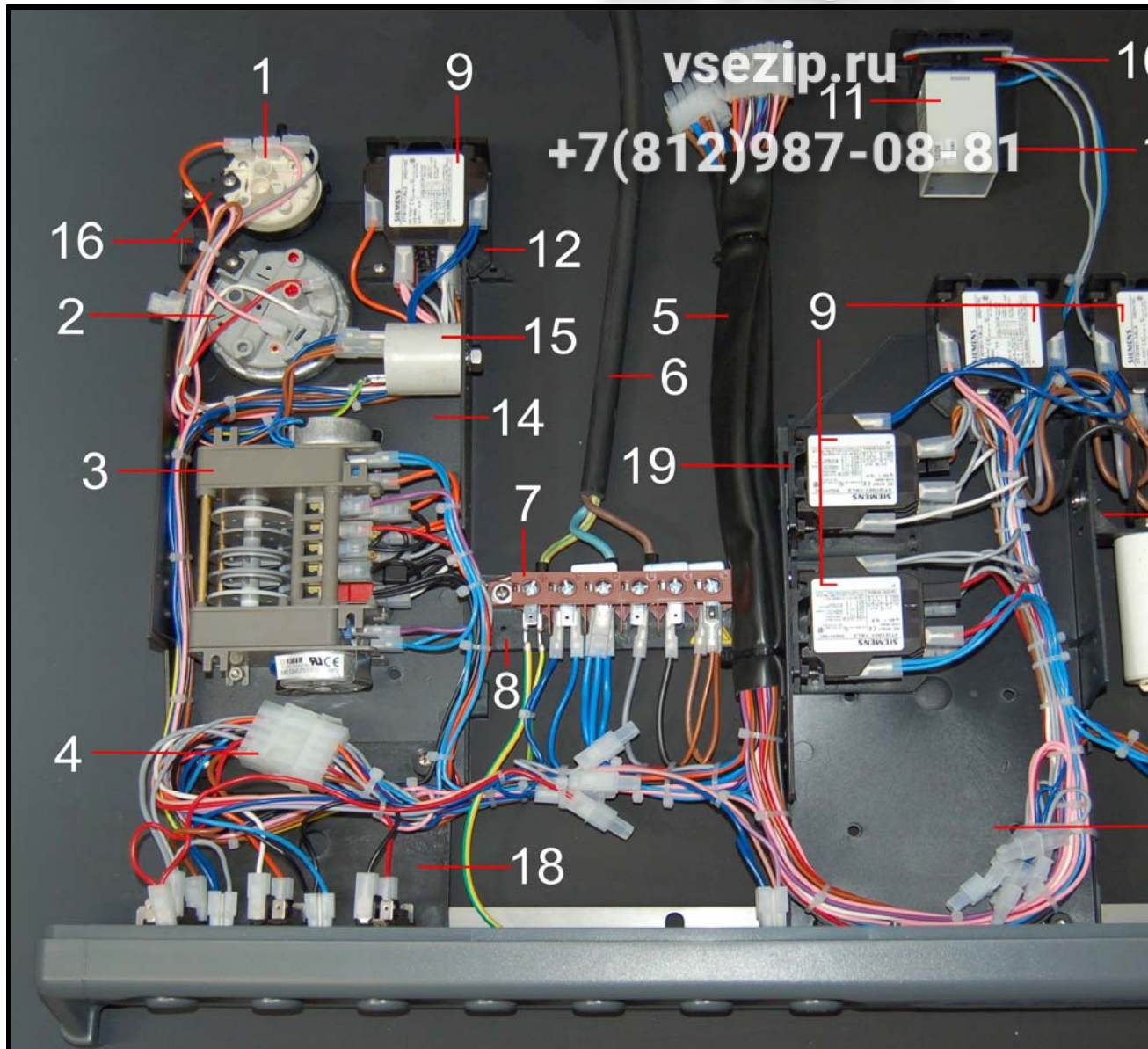

Pos.	Codice	Descrizione	Description	De
1	CEPRE	Pressostato 1 livello	Pressure switch, standard	Pressostat 1 niveau
2	CEPR62P	Pressostato 1 livello 30/90	Pressure switch, 30/90	Pressostat 1 niveau
3	CETD1224BGB	Timer ciclo doppio	Timer, 2-min & 4-min	Timer double cycle
4	CECBPC2V4GBABPS	Cablaggio pannello comandi	Control panel wiring loom	Cablage panneau c
5	CECBS2T482GBABPS	Cablaggio superiore	Upper loom	Cablage supérieur
6	CECE3536	Cavo alimentazione 3x6 mm	Main supply cable 3x6mm	Cablage d'alimenta
7	CEM0S3F	Morsettiera trifase	Main terminal block, 6-way	Bornier
8	CEPFM	Piastrina fissaggio morsettiera	Extension plate for terminal block	Plaquette fixage b
9	CECTF	Teleruttore	4-pole contactor	Contacteur
10	CETF60A	Zoccolo ritardatore	Base for delay timer	Socle temporisateu
11	CETF024	Ritardatore air break	Delay timer Air Break system	Temporisateur ABS
12	AM05SQTLL1	Piastrina fissaggio 1 teleruttore	Bracket for delay timer	Plaquette contacteur
13	CECN12	Condensatore 12,5mf	Capacitor 12,5 mf	Condensateur
14	CEPCE	Piastra cablaggio	Component tray, no components	Plaque composants
15	CEFA	Filtro antidisturbo	Suppressor	Fitre électrique
16	AM05SQTLL1	Piastrina fissaggio 1 teleruttore	Bracket for delay timer	Plaquette contacteur
17	CEM0S3F	Morsettiera trifase	Main terminal block, 6-way	Bornier
18	CEPFM	Piastrina fissaggio morsettiera	Extension plate for terminal block	Plaquette fixage b
19	CECTF	Teleruttore	4-pole contactor	Contacteur

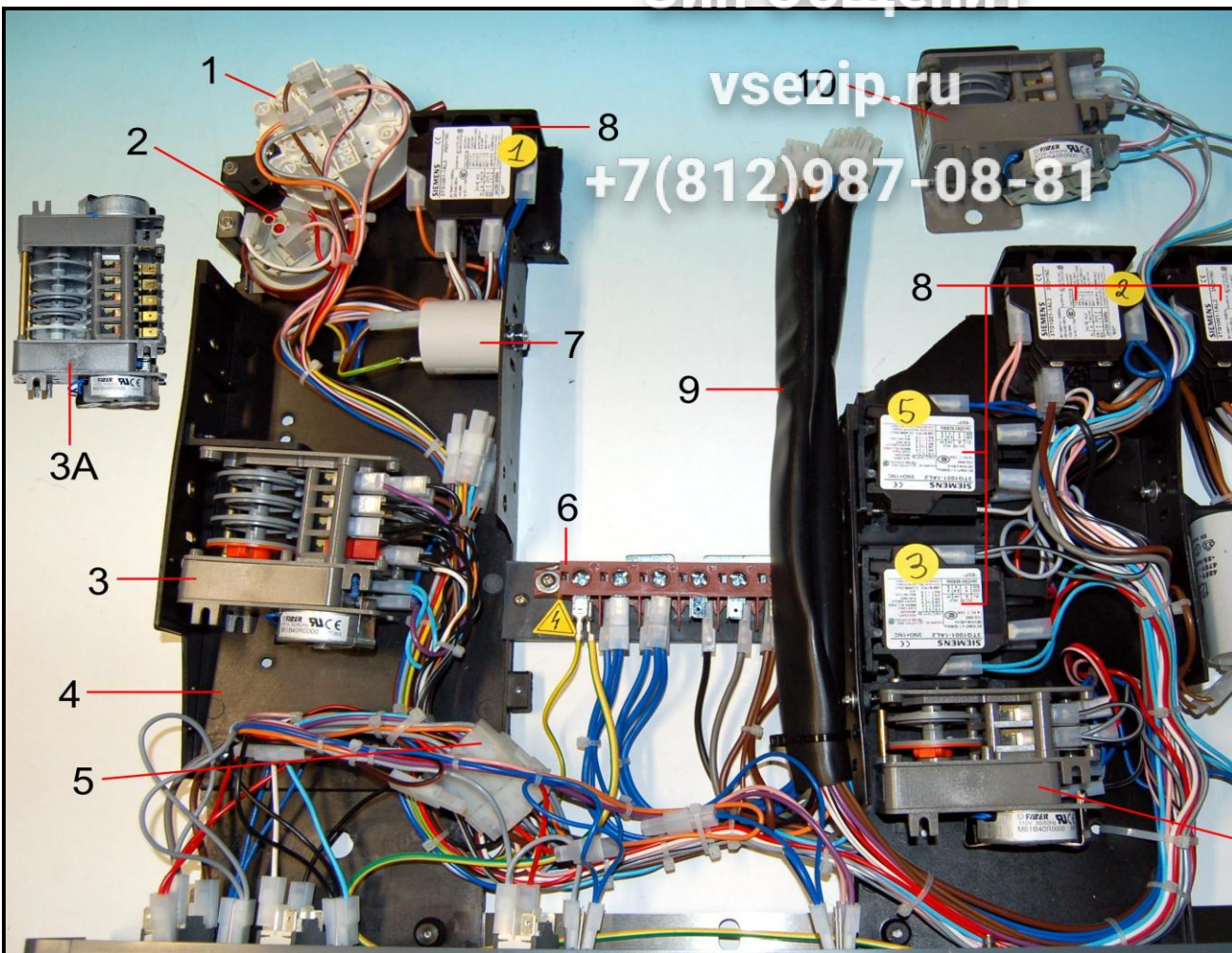

Pos.	Codice	Descrizione	Description	De
1	CEPRE2LUL	Pressostato 2 livelli	Pressure switch	Pressostat 2 nivea
2	CEPR62P	Pressostato 1 livello 30/90	Pressure switch, 30/90	Pressostat 1 nivea
3	CETF12BGB	Timer ciclo fisso 120"	Cycle timer - 2 min.	Timer cycle
3A	CETD1224BGB	Timer ciclo doppio	Timer, 2-min & 4-min	Timer double cycle
4	CEPCE	Piastra cablaggio	Component tray, no components	Plaque composant
5	CECBPC2V4GBABPS	Cablaggio pannello comandi	Control panel wiring loom	Cablage panneau c
6	CEM0S3F	Morsettiera trifase	Main terminal block, 6-way	Bornier
7	CEFA	Filtro antidisturbo	Suppressor	Filtre électrique
8	CECTF	Teleruttore	4-pole contactor	Contacteur
9	CECBS2T482GBABPS	Cablaggio superiore	Upper loom	Cablage supérieur
10	CETF2CPABS	Timer 2 camme per pompa ABS	Timer for ABS pump	Timer double pour
11	CECN12	Condensatore 12,5mf	Capacitor 12,5 mf	Condensateur
12	CEPSTFB	Timer pompa scarico timer 180" 220V	Drain timer, 180" 220V	Timer cycle de vid

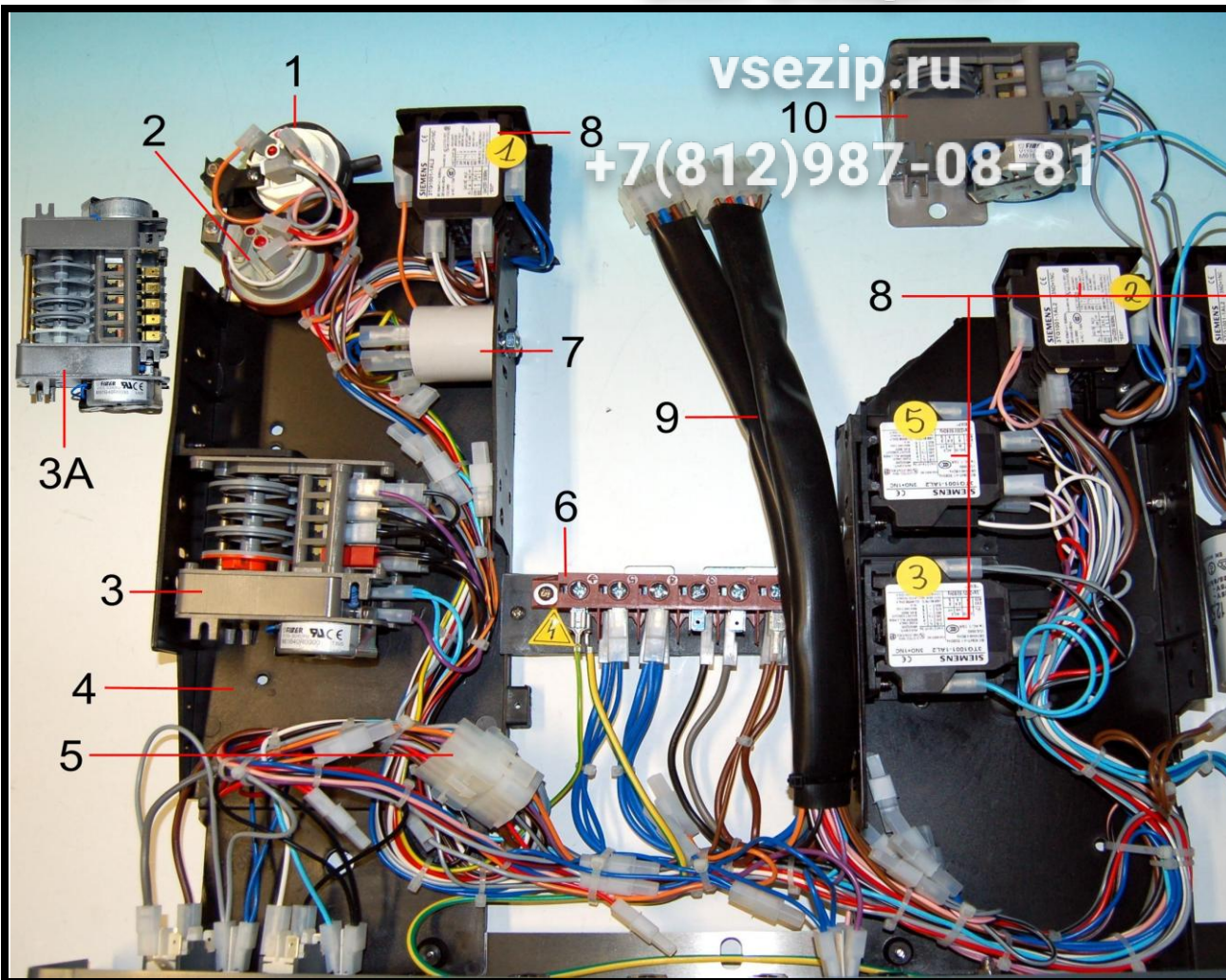

Pos.	Codice	Descrizione	Description	De
1	CEPRE	Pressostato 1 livello	Pressure switch, standard	Pressostat 1 niveau
2	CEPR62P	Pressostato 1 livello 30/90	Pressure switch, 30/90	Pressostat 1 niveau
3	CETF12BGB	Timer ciclo fisso 120"	Cycle Timer - 2 min.	Timer cycle
3A	CETD1224BGB	Timer ciclo doppio	Timer, 2-min & 4-min	Timer double cycle
4	CEPCE	Piastra cablaggio	Component tray, no components	Plaque composant
5	CECBPC2V4GBABPS	Cablaggio pannello comandi	Control panel wiring loom	Cablage panneau c
6	CEM0S3F	Morsettiera trifase	Main terminal block, 6-way	Bornier
7	CEFA	Filtro antidisturbo	Suppressor	Filtre électrique
8	CECTF	Teleruttore	4-pole contactor	Contacteur
9	CECBS2T482GBABPS	Cablaggio superiore	Upper loom	Cablage supérieur
10	CETF2CPABS	Timer 2 camme per pompa ABS	Timer for ABS pump	Timer double pour
11	CECN12	Condensatore 12,5mf	Capacitor 12,5 mf	Condensateur

Зип Общепит

vsezip.ru

+7(812)987-08-81

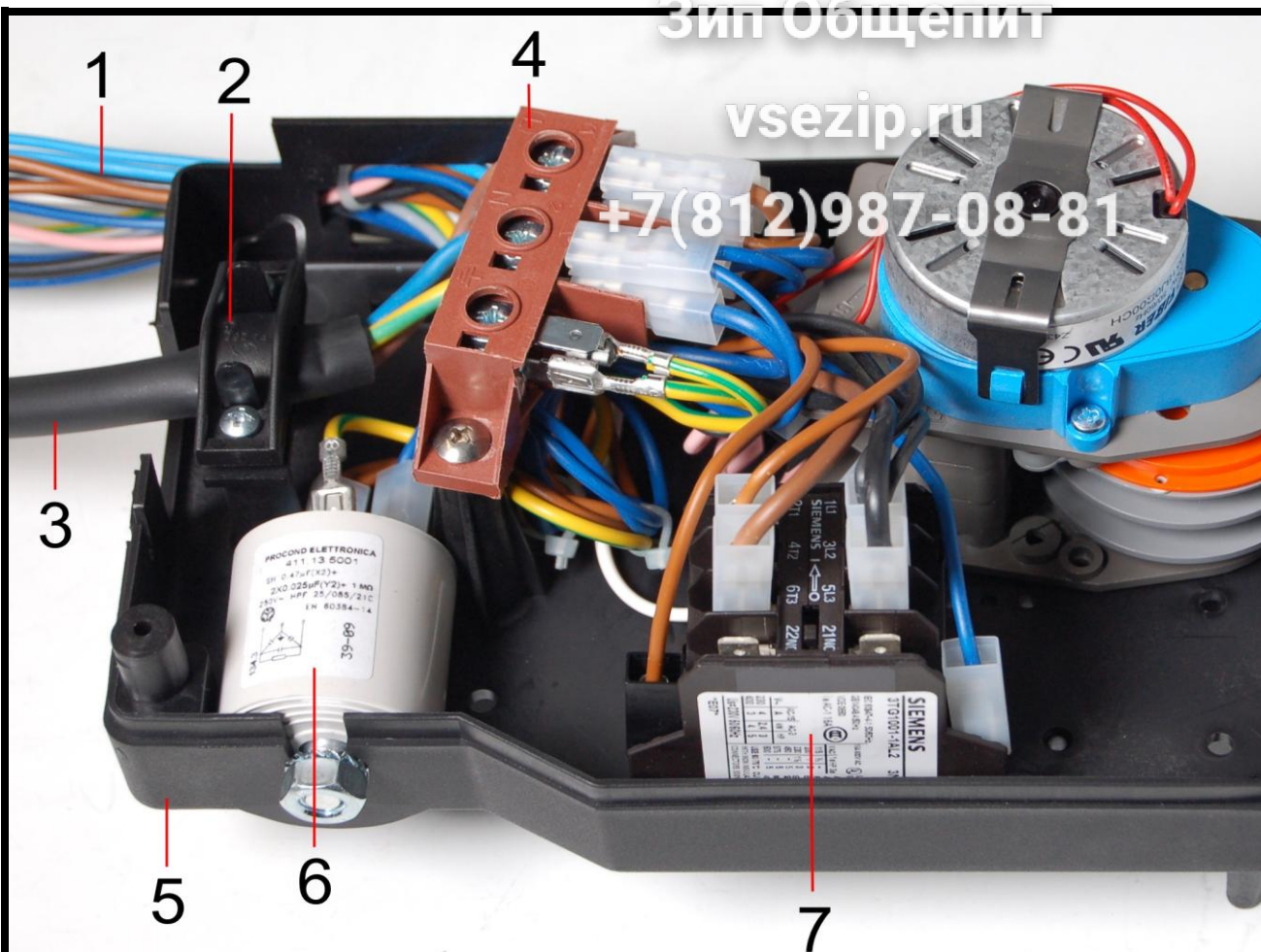

Pos.	Codice	Descrizione	Description	De
1	CECBJ09	Cablaggio	Lower loom	Cable de connexion
2	CEFI6	Fissacavo interno con viti	Cable clamp	Arrêt de câble intéri
3	CECE25	Cavo alimentazione monofase	Electric supply cable	Cable d'alimentatio
4	CEM0S	Morsettiera monofase	Main terminal block, 3-way	Bornier
5	CEPCEBCSL	Base scatola cablaggio	Electric component box body	Boite cablage
6	CEFA	Filtro antidisturbo	Suppressor	Filtre électrique
7	CECTF	Teleruttore	4-p contactor	Contacteur
8	CETF12	Timer ciclo	Cycle timer, 2,1/2 mins, type B	Timer cycle
9	CEPCECCSL	Coperchio scatola cablaggio	Electric component box lid	Couvercle boite cab
10	CECBICMJ09	Scatola cablaggio completa assemblata	Electrical component assembly	Boite cablage

Зип Общепит

vsezip.ru

+7(812)987-08-81

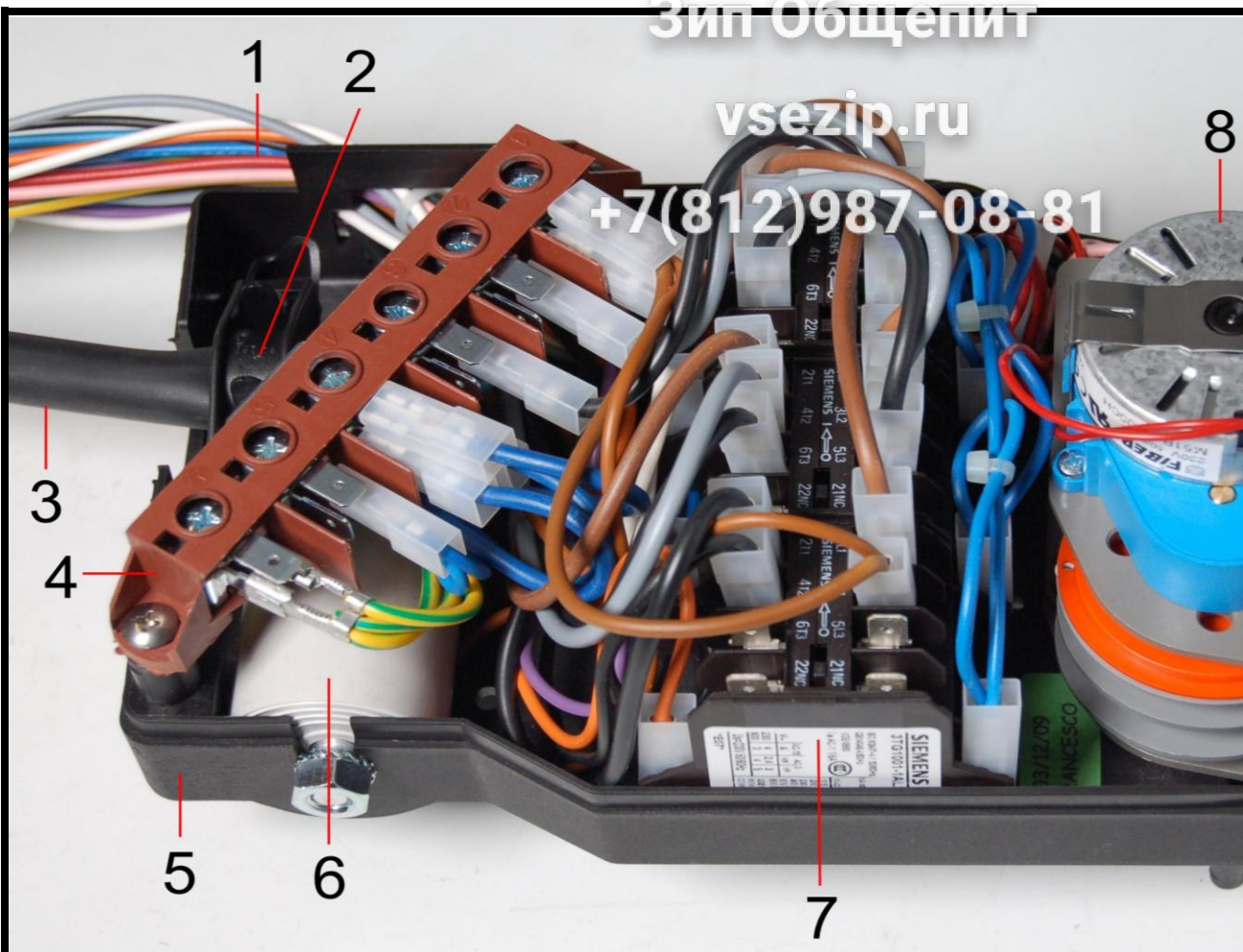

Pos.	Codice	Descrizione	Description	De
1	CECBI5T09	Cablaggio	Lower loom	Cable de connexion
2	CEFI6	Fissacavo interno con viti	Cable clamp	Arrêt de câble intér
3	CECE353F	Cavo alimentazione trifase	Electric supply cable - 3ph	Cable d'alimentatio
4	CEM0S3F	Morsettiera trifase	Main terminal block, 6-way	Bornier
5	CEPCEBCSL	Base scatola cablaggio	Electric component box body	Boîte cablage
6	CEFA	Filtro antidisturbo	Suppressor	Filtre électrique
7	CECTF	Teleruttore	4-p contactor	Contacteur
8	CETF12	Timer ciclo	Cycle timer, 2,1/2 mins, type B	Timer cycle
9	CEPCECCSL	Coperchio scatola cablaggio	Electric component box lid	Couvercle boîte cab
10	CECBICTJ09	Scatola cablaggio completa assemblata	Electrical component assembly	Boîte cablage

Зип Общепит

vsezi.ru

+7(812)987-08-81

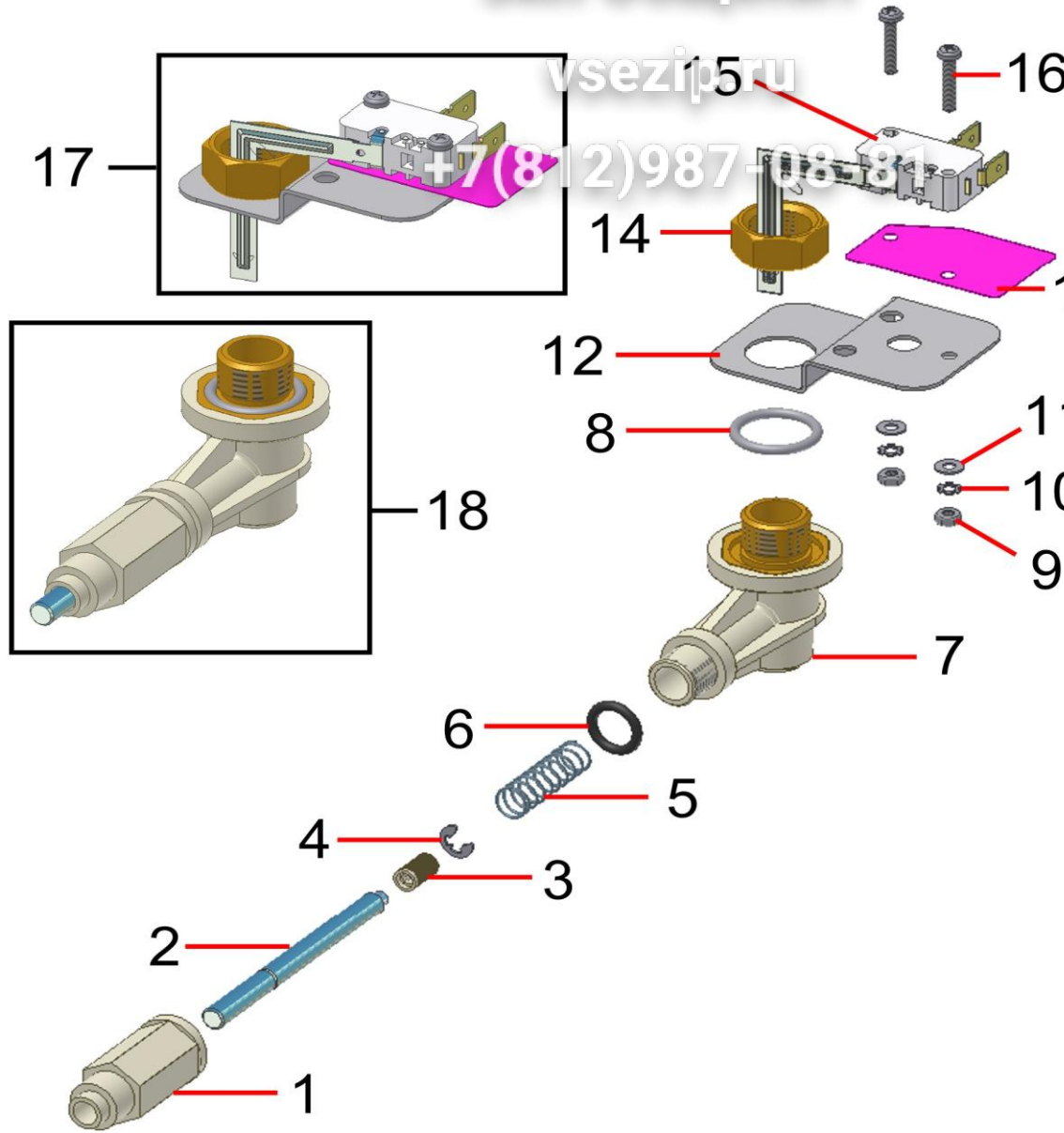

Pos.	Codice	Descrizione	Description	De
1	CEMP23B	Corpo anteriore sicurezza porta	Door plunger body	Corps antérieur
2	CEMP21	Astina sicurezza porta	Push rod	Tige sécurité porte
3	CEMPPIB	Puntale isolante astina sicurezza porta	Push rod end cap	Poussoir plastique
4	CEMP22	Seeger astina sicurezza porta	Circlip	Circlips
5	CEMP20	Molla sicurezza porta	Door plunger spring	Ressort sécurité p
6	OR4036	Or sicurezza porta	O ring 4036	Joint OR 4036
7	CEMP18B	Corpo posteriore sicurezza porta	Door plunger elbow	Corps postérieur
8	OR122	Or 122	O-ring 122	O-ring 122
9	VD3I	Dado M3	Nut	Ecrou
10	VR3I	Rondella dentellata Ø 3	Tab washer D. 3	Rondelle à denture
11	VRGB3I	Rondella grembialina Ø 3	Steel rod	Rondelle, d. 3
12	CEMP13CS	Squadretta micro porta standard	Bracket for door switch	Support interrupteu
13	CEISOMPNT	Isolante micro porta	Insulating plate	Isolant
14	D038A	Dado ottone 3/8"	Brass lock nut 3/8"	Ecrou 3/8"



Зип Общепит

vsezip.ru

+7(812)987-08-81

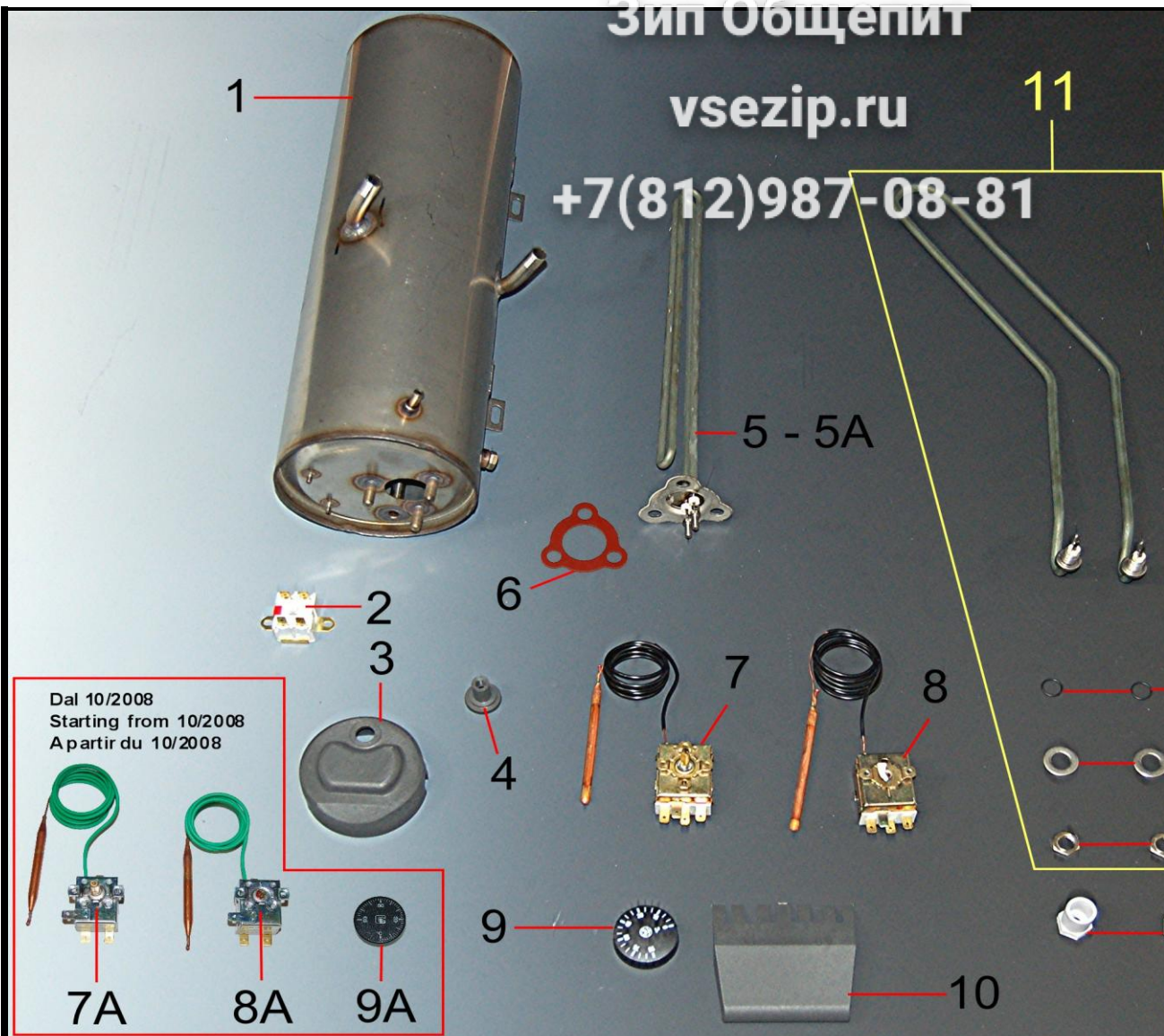

Pos.	Codice	Descrizione	Description	De
1	GB4821F	Boiler monofase	Boiler monophase	Surchauffeur monop
2	CESB454	Termostato sicurezza boiler	Rinse safety thermal switch	Termostat sécurité
3	GB08V0	Protezione resistenza boiler monofase	Rinse element guard, large	Protection résistan
4	GB09V0	Nottolino protezione boiler monofase	Securing nut, rinse element guard	Ecrou fixation prote
5	CERB30	Resistenza boiler 3000W	Rinse element 3kw	Résistance surchauf
5A	CERB22	Resistenza boiler 2200W	Rinse element 2,2kw	Résistance surchauf
6	G42303S	Guarnizione resistenza boiler monofase	Rinse element seal, small	Joint pour résistan
7	CETB85	Termostato boiler regolabile	Adjustable control thermostat	Thermostat surcha
7A	CETB85CAM	Termostato boiler regolabile (2008)	Adjustable control thermostat (2008)	Thermostat surcha
8	CETV55	Termostato vasca fisso	Fixed wash control thermostat	Thermostat cuve fi
8A	CETV55CAM	Termostato vasca fisso (2008)	Fixed wash control thermostat (2008)	Thermostat cuve fi
9	CEMTB	Manopola termostato	Knob, thermostat	Manette thermosta
9A	CEMTBCAM	Manopola termostato (2008)	Knob, thermostat (2008)	Manette thermosta
10	CEPRTV0	Protezione termostati	Thermostat protection	Protection résistan
11	CERV22	Resistenza vasca 2200W	Wash element 2,2kw	Résistance de cuve
12	ORRV	Or resistenza vasca	O-ring, wash element	Joint pour résistan
13	VRP12I	Rondella piana diam.12	Flat washer diam. 12	Rondelle diam. 12
14	VDRV	Dado resistenza vasca	Lock nut	Ecrou tenue résis

Зип Общепит

vsezip.ru

+7(812)987-08-81

11

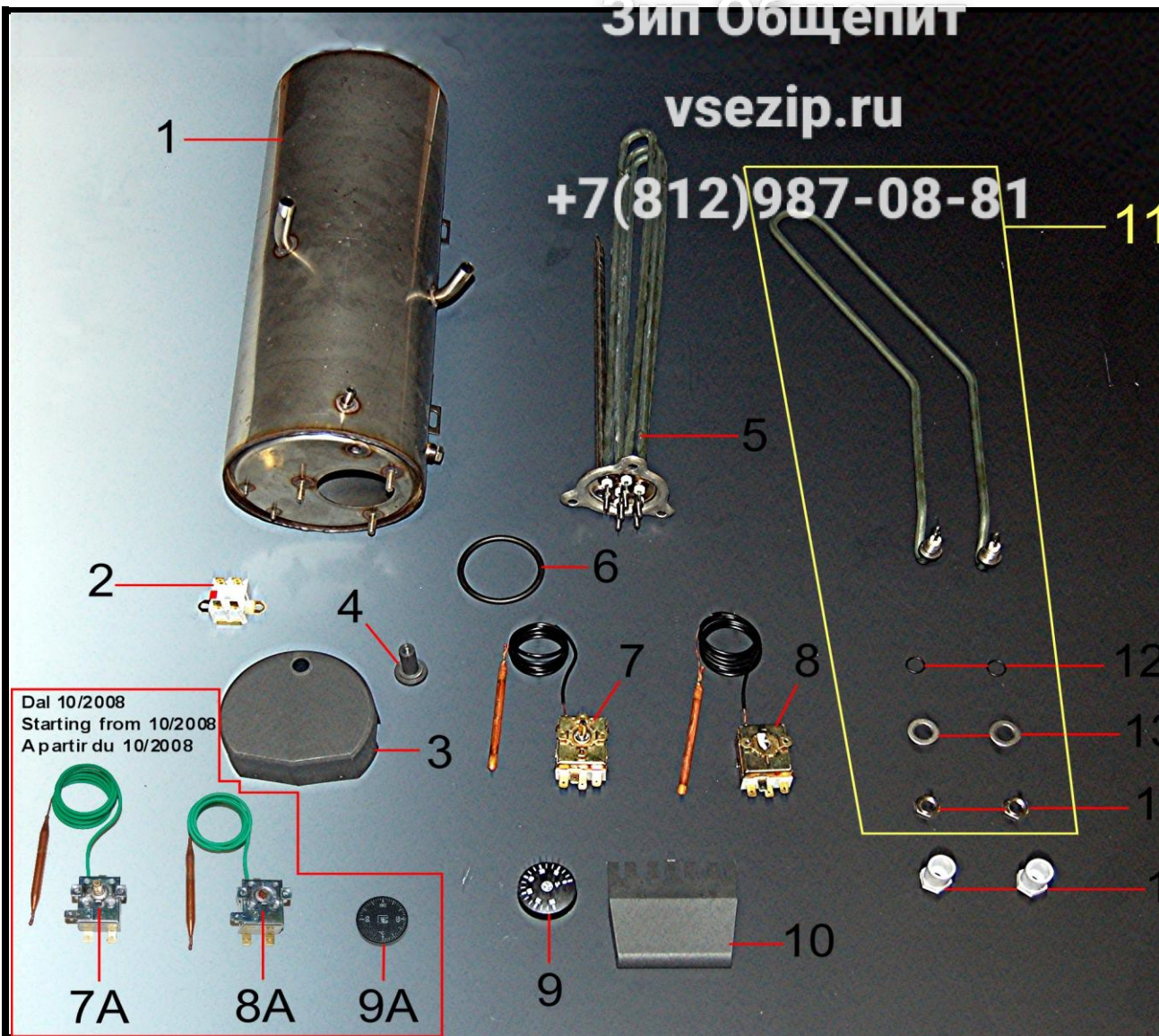

Dal 10/2008  
Starting from 10/2008  
A partir du 10/2008

Pos.	Codice	Descrizione	Description	Des
1	GB4823F	Boiler trifase	Boiler, 3ph	Surchauffeur, 3phase
2	CESB454	Termostato sicurezza boiler	Rinse safety thermal switch	Termostat sécurité
3	GB083FV0	Protezione resistenza boiler	Rinse element guard, large	Protection résistanc
4	GB093FV0	Nottolino protezione resistenza boiler	Retaining nut, rinse element, large	Ecrou fixation protec
5	CERB603F	Resistenza boiler trifase 6000W	Rinse element, 6.0 kw, 3ph	Résistance surchauff
6	ORRB3F	Or resistenza boiler trifase	Or boiler element	Joint pour resistanc
7	CETB85	Termostato boiler regolabile	Adjustable control thermostat	Thermostat surchaf
7A	CETB85CAM	Termostato boiler regolabile (2008)	Adjustable control thermostat (2008)	Thermostat surchaf
8	CETV55	Termostato vasca fisso	Fixed wash control thermostat	Thermostat cuve fix
8A	CETV55CAM	Termostato vasca fisso (2008)	Fixed wash control thermostat (2008)	Thermostat cuve fix
9	CEMTB	Manopola termostato	Knob, thermostat	Manette thermostat
9A	CEMTBCAM	Manopola termostato (2008)	Knob, thermostat (2008)	Manette thermostat
10	CEPRTV0	Protezione termostati	Guard thermostat	Protection thermost
11	CERV22	Resistenza vasca 2200W	Wash element, 2.2 kw	Résistance de cuve
12	ORRV	Or resistenza vasca	O-ring, wash element	Joint pour résistanc
13	VRP12I	Rondella piana diam. 12	Flat washer, diam. 12	Rondelle diam. 12
14	VDRV	Dado resistenza vasca	Lock nut	Ecrou tenue résista
15	CEPRVV0	Protezione resistenza vasca	Guard, wash element	Protection résistanc

Зип Общежит

vsezip.ru

+7(812)987-08-81



Pos.	Codice	Descrizione	Description	De
1	LS09PB	Nottolino fissaggio girante	Spindle retaining screw	Ecrou pour pivot
2	LSI46CSB	Asta risciacquo sinistra assemblata	Rinse arm, LH, complete	Rampe rinçage gau
3	LSI46CDB	Asta risciacquo destra assemblata	Rinse arm, RH, complete	Rampe rinçage dro
4	LSI46BSB	Asta lavaggio sinistra assemblata	Wash arm, LH, complete	Rampe lavage gau
5	LSI46BDB	Asta lavaggio destra assemblata	Wash arm, RH, complete	Rampe lavage droi
6	LSI0607AB	Mozzo girante	Centre boss c/w bushes	Moyeu central
7	LSI46CB	Asta risciacquo	Rinse arm only	Rampe rinçage
8	LSI46BB	Asta lavaggio	Wash arm only	Rampe lavage
9	LSI021B	Ghiera fissaggio getto risciacquo	Rnse jet retaining ring	Ecrou fix. gicleur rin
10	LSI022B	Tappo getto risciacquo	Rinse arm blank	Bouchon
11	LSI020B	Getto risciacquo	Rinse jet	Gicleur rinçage
12	LSI017B	Ghiera fissaggio getto lavaggio	Wash jet ring nut	Ecrou fix. gicleur la
13	LSI015B	Getto lavaggio destro stretto	Wash jet, RH marked "d"	Gicleur lavage droi

vsezip.ru

+7(812)987-08-81

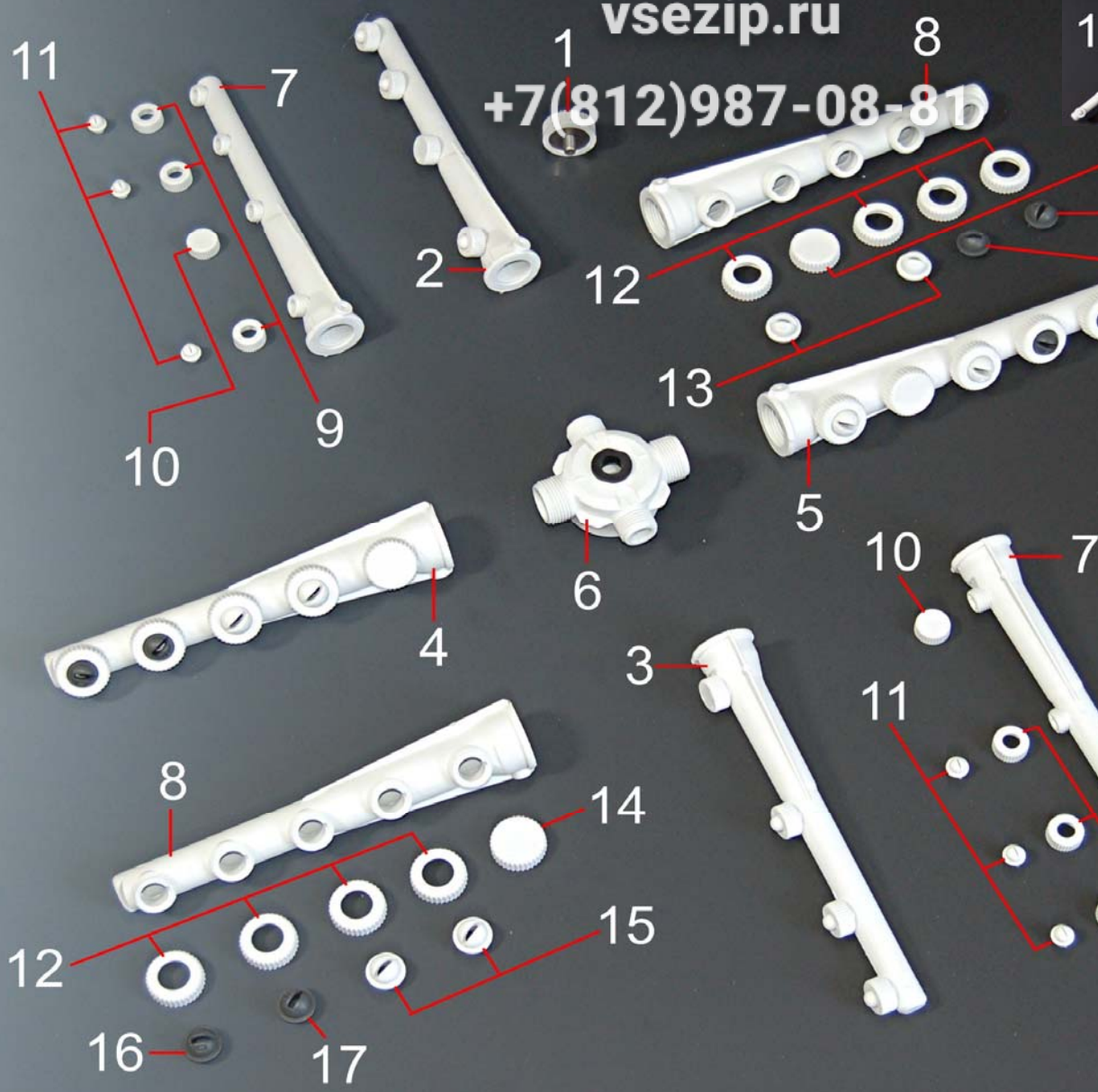

Pos.	Codice	Descrizione	Description	De
1	LS09PB	Nottolino fissaggio girante	Spindle retaining screw	Ecrou pour pivot
2	LSI46CSB	Asta risciacquo sx con getti	Rinse arm, LH, complete	Rampe rinçage gau
3	LSI46CDB	Asta risciacquo dx con getti	Rinse arm, RH, complete	Rampe rinçage dro
4	LSI46BSBDS	Asta lavaggio sx con getti doppia parete	Wash arm LH, complete	Rampe lavage gau
5	LSI46BDBDS	Asta lavaggio dx con getti doppia parete	Wash arm RH, complete	Rampe lavage droi
6	LSI0607AB	Mozzo girante	Centre boss, complete with bushes	Moyeu tournant ave
7	LSI46CB	Asta risciacquo bianca	Rinse arm only	Rampe rinçage blan
8	LSI46BB	Asta lavaggio	Wash arm only	Rampe lavage blan
9	LSI021B	Ghiera fissaggio getto risciacquo	Rinse jet retaining ring	Ecrou gicleur rinça
10	LSI022B	Tappo getto risciacquo	Rinse arm blanking cover	Bouchon gicleur rin
11	LSI020B	Getto risciacquo	Rinse jet	Gicleur rinçage
12	LSI017B	Ghiera fissaggio getto lavaggio	Wash jet ring nut	Ecrou gicleur lavag
13	LSI015B	Getto lavaggio dx stretto	Wash jet, RH, marked D	Ecrou gicleur lavag

Зип Общепит

vsezip.ru

+7(812)987-08-81

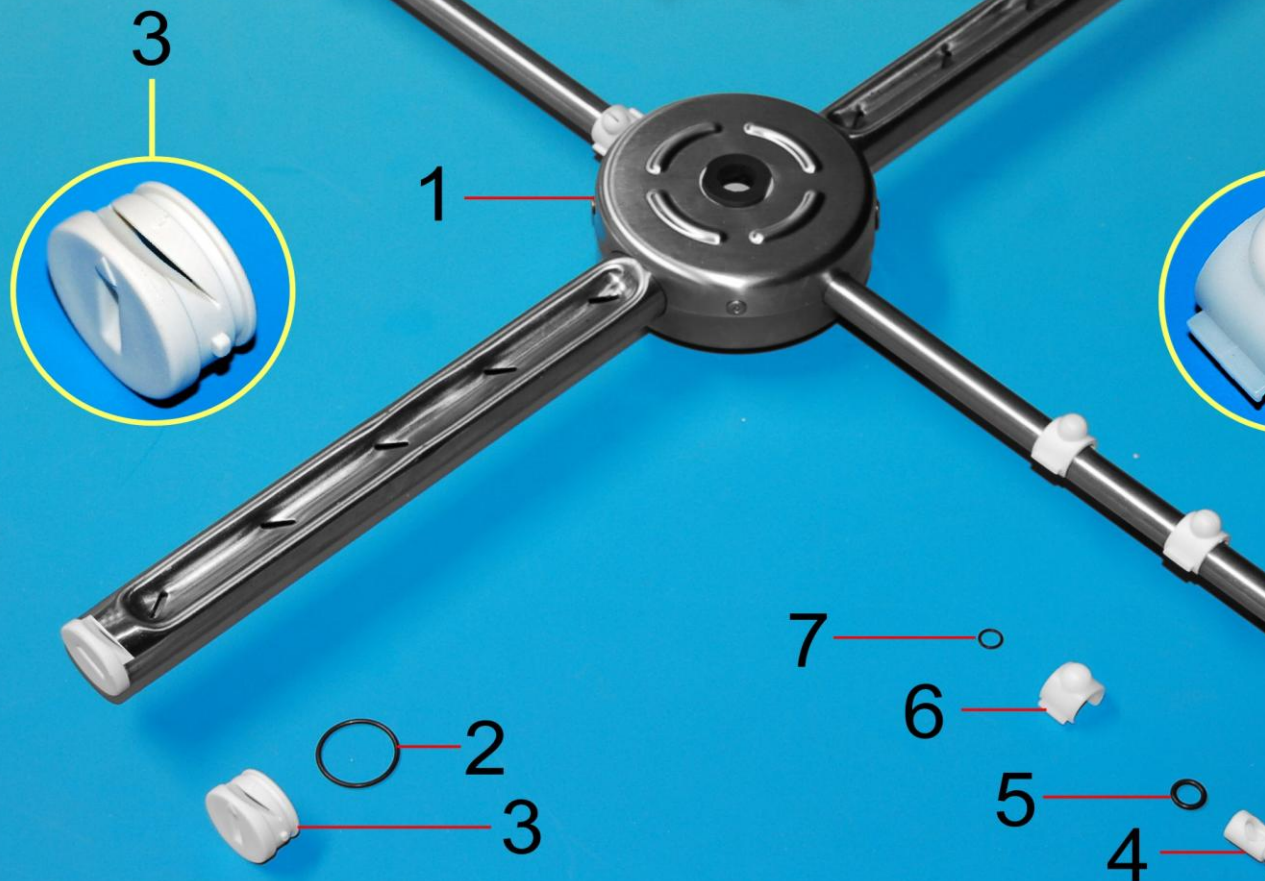

Pos.	Codice	Descrizione	Description	De
1	LSI46I08C	Girante inox completa assemblata	Rotating stainless steel wash assy complete	Couronne complete
2	OR20515	Or 20,5 x 1,5	Or 20,5 x 1,5	Joint torique 20,5
3	LSI018GIGLFB	Tappo asta lavaggio inox	Stainless steel wash arm plug	Bouchon inox ramp
4	GR019GB	Tappo asta risciacquo	Rinse arm plug	Bouchon rampe rin
5	OR106	Or 106	Or 106	Joint torique 106
6	LSI020GIB	Getto risciacquo	Rinse jet	Gicleur rinçage
7	OR5501	Or 5,5 x 1	Or 5,5 x 1	Joint torique 5,5 x

Зип Общепит

vsezip.ru

+7(812)987-0088

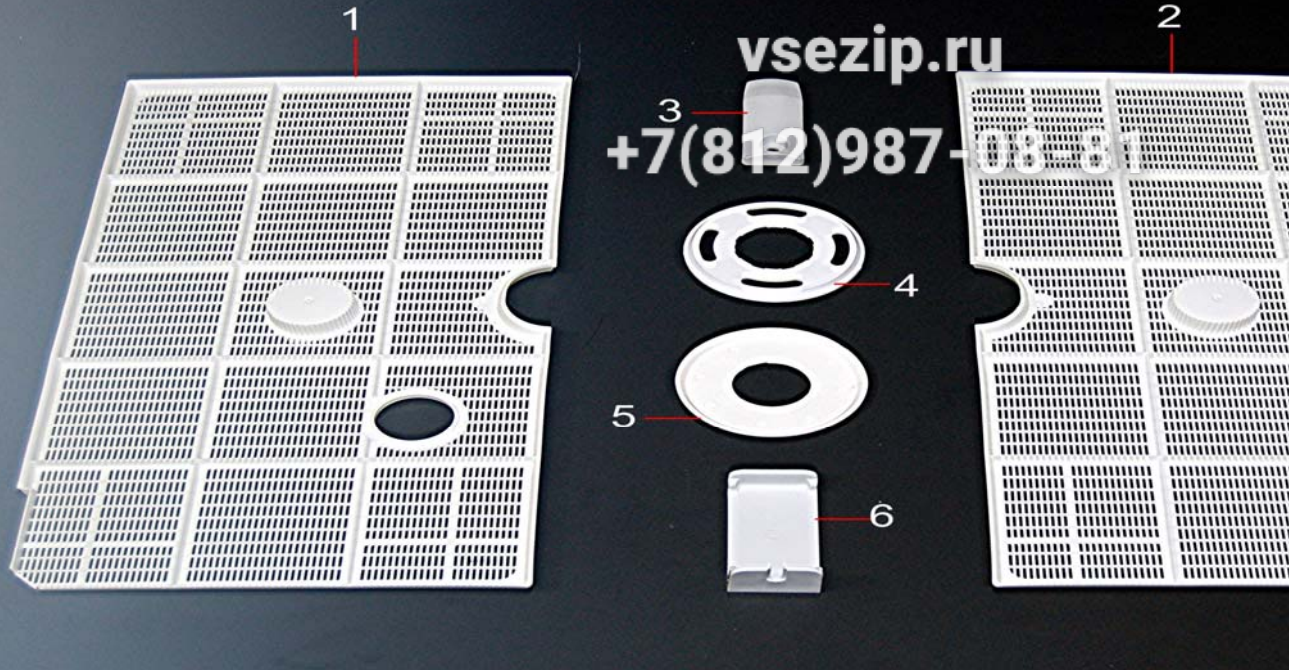

Pos.	Codice	Descrizione	Description	De
1	LIF4V2PSX04	Filtro superficie sinistro con foro	Top filter section, LH, with hole	Filtre de surface ga
2	LIF4V2PDX04	Filtro superficie destro	Top filter section, RH, no hole	Filtre de surface dr
3	AM0APF4B	Appoggio posteriore filtri superficie	Rear filter support	Support postérieur
4	LI034P2F04	Ghiera inferiore appoggio filtri superficie	Filter support disk, with slots	Disque inférieur de
5	LI034PV0	Ghiera inferiore	Deflector disk	Déflecteur
6	AM0AAF4B	Appoggio anteriore filtri superficie	Front filter support	Support antérieur fi

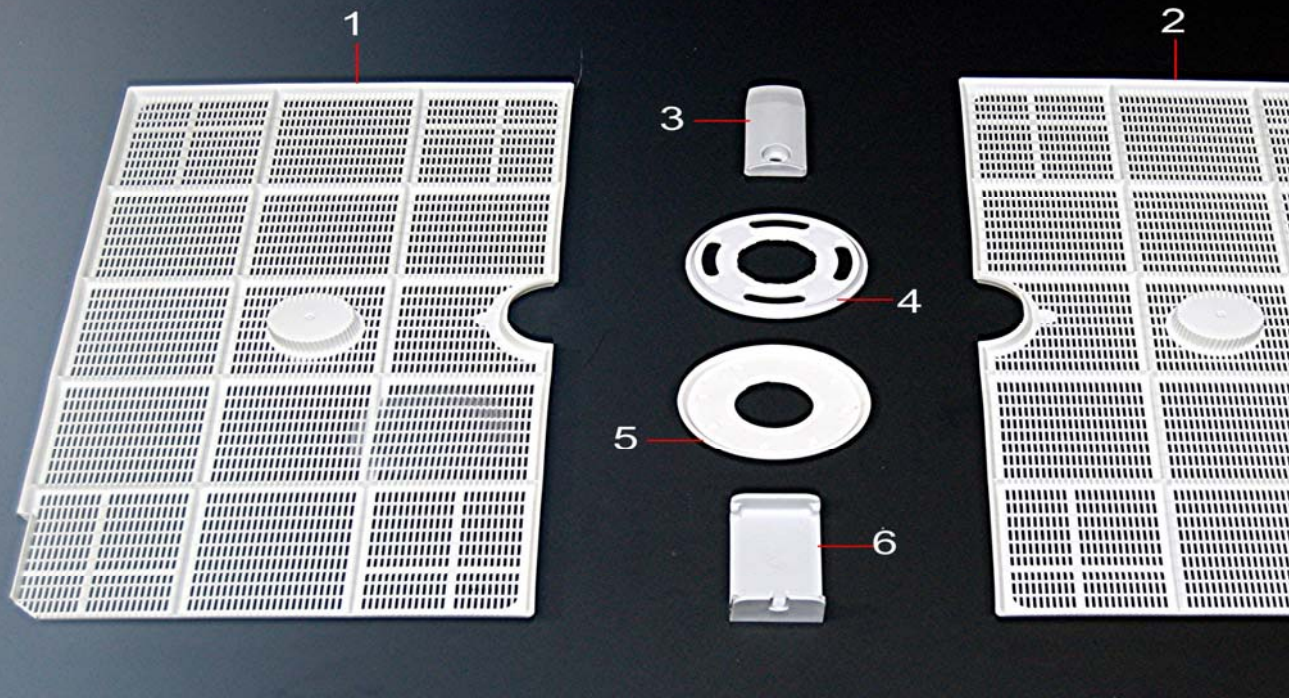

Pos.	Codice	Descrizione	Description	De
1	LIF4V2PSX04	Filtro superficie sinistro	Top filter section, LH, no hole	Filtre de surface

Зип Общежит



Pos.	Codice	Descrizione	Description	De
1	GA013B	Ghiera fissaggio filtro aspirazione	Filter retaining nut	Ecrou filtre
2	GA315RV0	Filtro aspirazione	Wash filter upper body	Filtre d'aspiration
3	GA315RAV0	Piastra filtro aspirazione	Wash filter base	Plaque filtre aspirat
4	GA61220T	Astina filtro aspirazione	Filter spindle	Tige de filtre aspira
5	GA311B	Piletta aspirazione	Filter boss	Bonde d'aspiration
6	OR3187	Or piletta aspirazione	O-ring 3187	O-ring 3187
7	DP112	Dado 1" 1/2	Plastic nut 1.1/2"	Ecrou pour bonde d
8	GA538	Manicotto aspirazione	Wash inlet hose	Durite d'aspiration
9	EP100	Elettropompa 1 hp	Washpump, 1.0 hp	Pompe de lavage,
10	GLMSIC404	Manicotto mandata	Wash outlet hose	Durite de refouleme
11	LS5B	Supporto superiore	Top boss	Support supérieur
12	LS02	Guarnizione supporto superiore	Cork seal	Joint
13	LS03PC	Ghiera superiore assemblata	Baffle plate	Deflecteur
14	LS08	Perno inox lungo	Wash spindle	Pivot inox
15	LI430FCB	Piletta entrata lavaggio inferiore	Wash inlet elbow	Bonde entrée comp
16	LI428	Tubo inox interno	Spacer tube	Tuyau inox
17	LI029CAB	Supporto inferiore	Bottom boss assy	Support inferieur
18	LI330	Prolunga perno inox	Spindle extension	Extension pivot
19	LI533FOT	Supporto inferiore risc.	Support for bottom boss	Support inferieur ri
20	OR122	Or supporto risciacquo	O-ring 122	O-ring

vsezip.ru

+7(812)987-08-81



Pos.	Codice	Descrizione	Description	Des
1	GS416CCAB	Troppo pieno	Drain plug or standpipe	Tuneau de trop-ple
2	GS317B	Piletta scarico	Drain outlet boss	Bonde de vidange
3	OR3168	Or piletta scarico	O-ring	Joint torique bonde
4	DP114	Dado 1" 1/4 ppl	Plastic nut	Ecrou plastique por
5	FAM4050	Fascetta a molla	Spring clip	Collier élastique
6	GS520	Manicotto scarico	Drain hose	Durite de vidange
7	GS321B	Raccordo scarico 90°	Drain outlet elbow	Raccord à 90° de v
8	GS330	Tubo scarico	Waste outlet hose (gravity)	Tuyau de vidange
9	GP025B	Trappola aria	Air trap	Chambre de compr
10	G382615G	Guarnizione trappola aria	Airtrap seal	Joint chambre de c
11	D034	Dado ottone 3/4	Brass nut, 3/4	Ecrou 3/4
12	G251525G	Guarnizione raccordo girevole	Sealing washer	Joint
13	GP026BB	Dado raccordo girevole	Airtrap elbow nut, white	Ecrou pour raccord
14	GP026AB	Raccordo girevole	Airtrap elbow, white	Raccord tournant
15	TSII 48	Tubo silicone 4x8 mm	Silicon tube 4/8mm	Tuyau silicone 4x



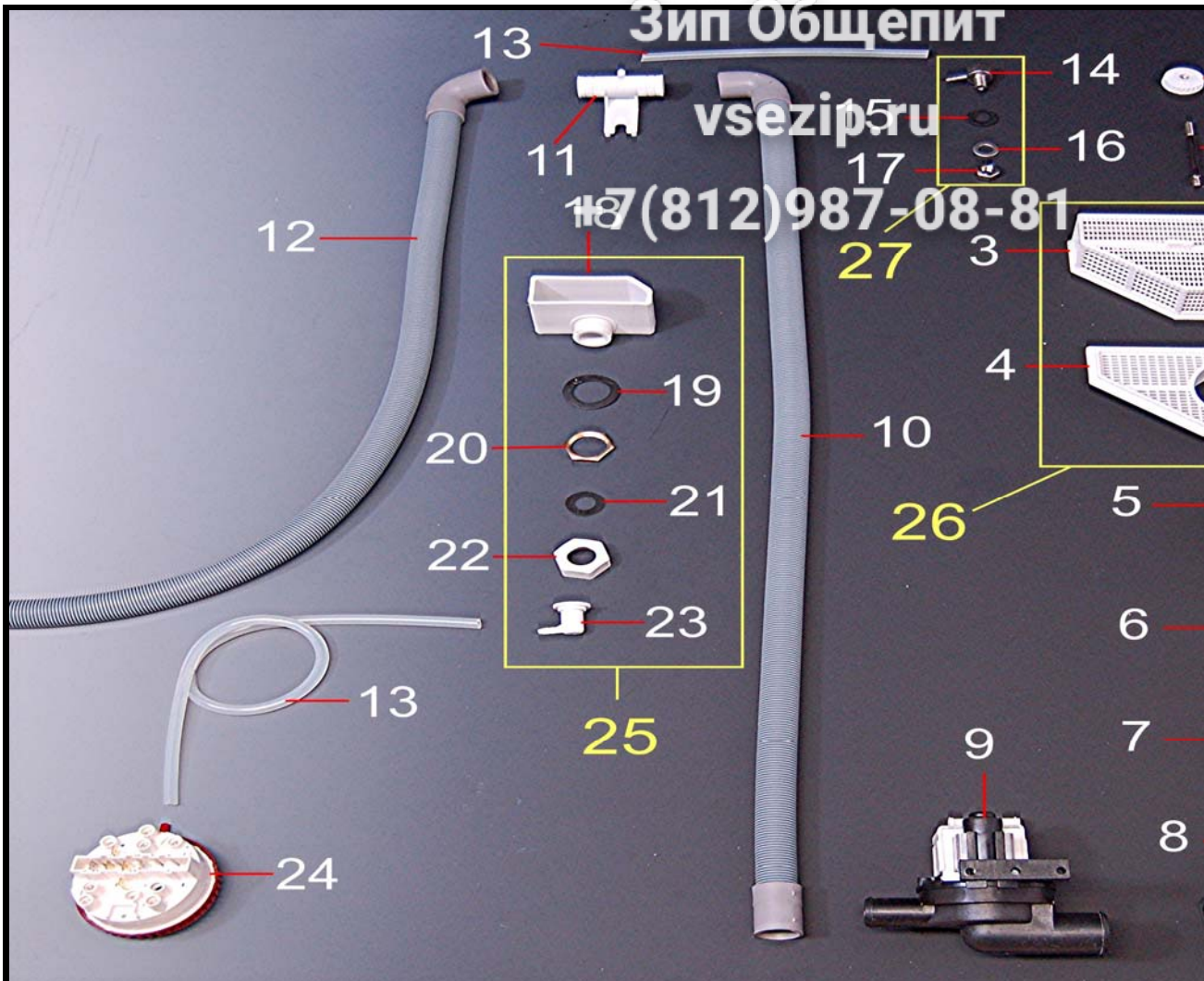

Pos.	Codice	Descrizione	Description	De
1	GA013B	Nottolino filtro	Filter retaining nut	Ecrou tenue filtre
2	GAGS599	Tirante filtro	Filter spindle	Tige de filtre
3	GA115RV0	Filtro aspirazione	Upper body, drain filter	Filtre d'aspiration
4	GA115RABV0	Piastra filtro aspirazione pompa scarico	Base, Drain filter	Plaque fitre d'aspiration
5	GA111TB	Piletta aspirazione pompa scarico	Drain filter boss	Bonde d'aspiration
6	OR3168	Or 3168	O-ring 3168	Joint OR 3168
7	DP114	Dado 1"1/4	Plastic nut 1.1/4"	Ecrou 1"1/4
8	GA18PS5USA	Manicotto aspirazione pompa scarico	Drain pump inlet hose	Durite d'aspiration
9	CEPS5	Pompa scarico	Drain pump	Pompe de vidange
10	GSTS820PS	Tubo scarico 1.820mm	Internal drain hose	Tube de vidange 1,
11	CEPSVSF	Valvola non ritorno scarico	Drain non return valve	Clapet anti non ret
12	GSTS2500PS	Tubo scarico 1.2500mm	External drain outlet hose	Tube de vidange 1,
13	TSIL48	Tubo silicone	Silicone tube	Tube silicone
14	GSDETPI10	Comp inox	Connection elbow, steel	Support inox
15	G24112	Guarnizione 24x11x2	Seal, 24x11x2	Joint 24x11x2
16	VRP10I	Rondella piana diam. 10mm	Plain washer, dm. 10mm	Rondelle, dm. 10m
17	VD10I	Dado m10	Nut, m10	Ecrou m 10
18	GP025B	Trappola aria	Pressure vessel only	Chambre de compr
19	G382615G	Guarnizione 38x26x1,5	Seal 38x26x1.5	Joint 38x15x2,5
20	D034	Dado 3/4"	Brass nut, 3/4	Ecrou 3/4"
21	G251525G	Guarnizione 25x15x2,5	Sealing washer	Joint 25x15x2,5

Зип Общепит

vsezip.ru

+7(812)987-08-81

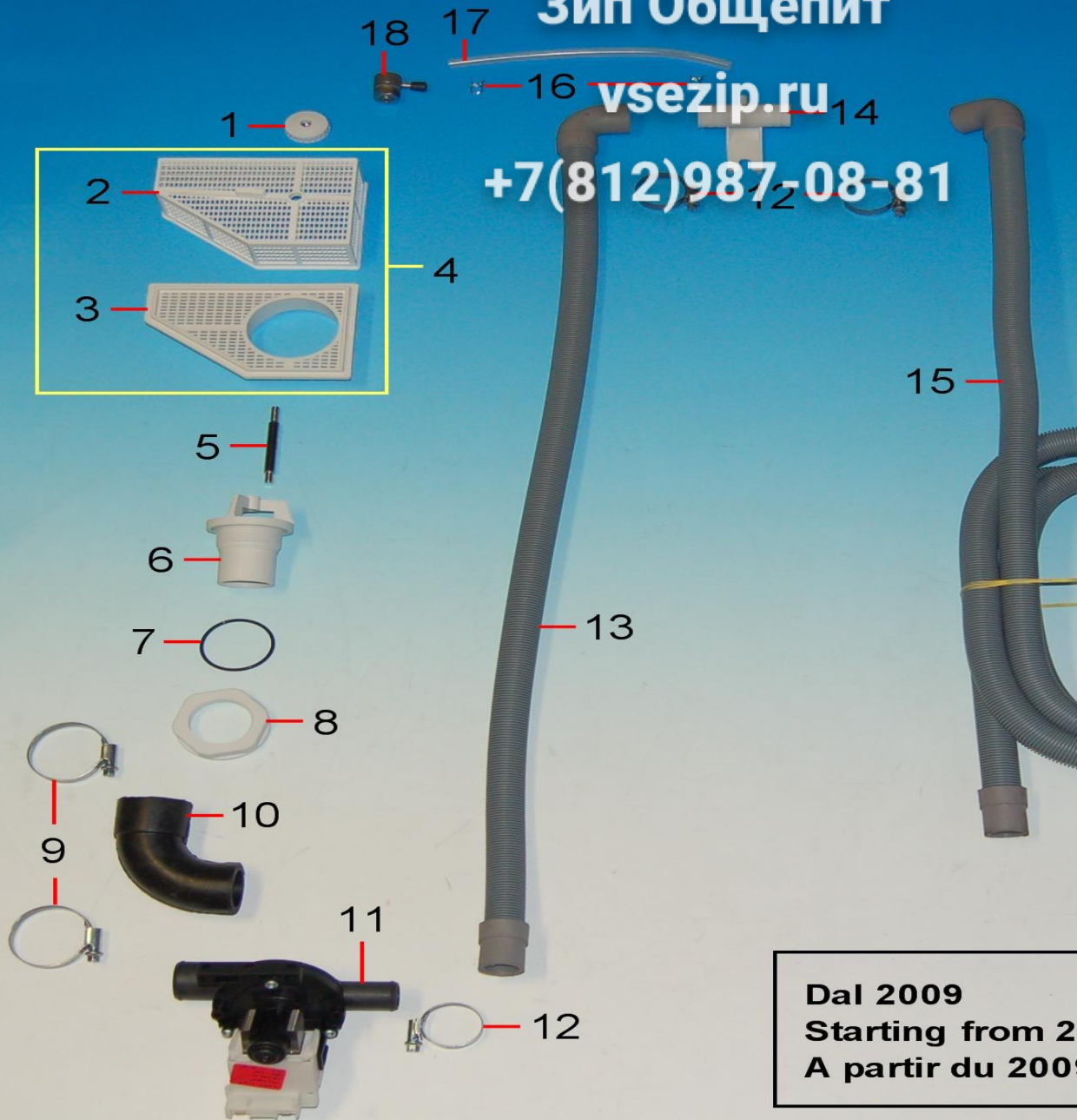

Pos.	Codice	Descrizione	Description	Des
1	GA013B	Nottolino filtro	Filter retaining nut	Ecrou de filtre
2	GA115RV0	Filtro aspirazione	Upper body, drain filter	Filtre d'aspiration
3	GA115RABV0	Piastra filtro aspirazione pompa scarico	Base, Drain filter	Plaque filtre d'aspiration
4	GA115SCOMP	Filtro aspirazione completo	Drain filter top and base complete	Filtre d'aspiration c
5	GAGS599	Tirante filtro	Filter spindle	Tige de filtre
6	GA111TB	Piletta aspirazione pompa scarico	Drain filter boss	Bonde d'aspiration
7	OR3168	Or 3168	O-ring 3168	Joint OR 3168
8	DP114	Dado 1"1/4	Plastic nut 1.1/4"	Ecrou 1"1/4
9	FA3040	Fascetta	Hose clip 30-40	Collier élastique
10	GA18PS5USA	Manicotto aspirazione pompa scarico	Drain pump inlet hose	Durite d'aspiration
11	CEPS5	Pompa scarico	Drain pump	Pompe de vidange
12	FA2532	Fascetta	Hose clip 25-32	Collier
13	GSTS820PS	Tubo scarico l.820 mm	Internal drain hose	Tuvau de vidange

Зип Общепит

vsezip.ru

+7(812)987-08-81

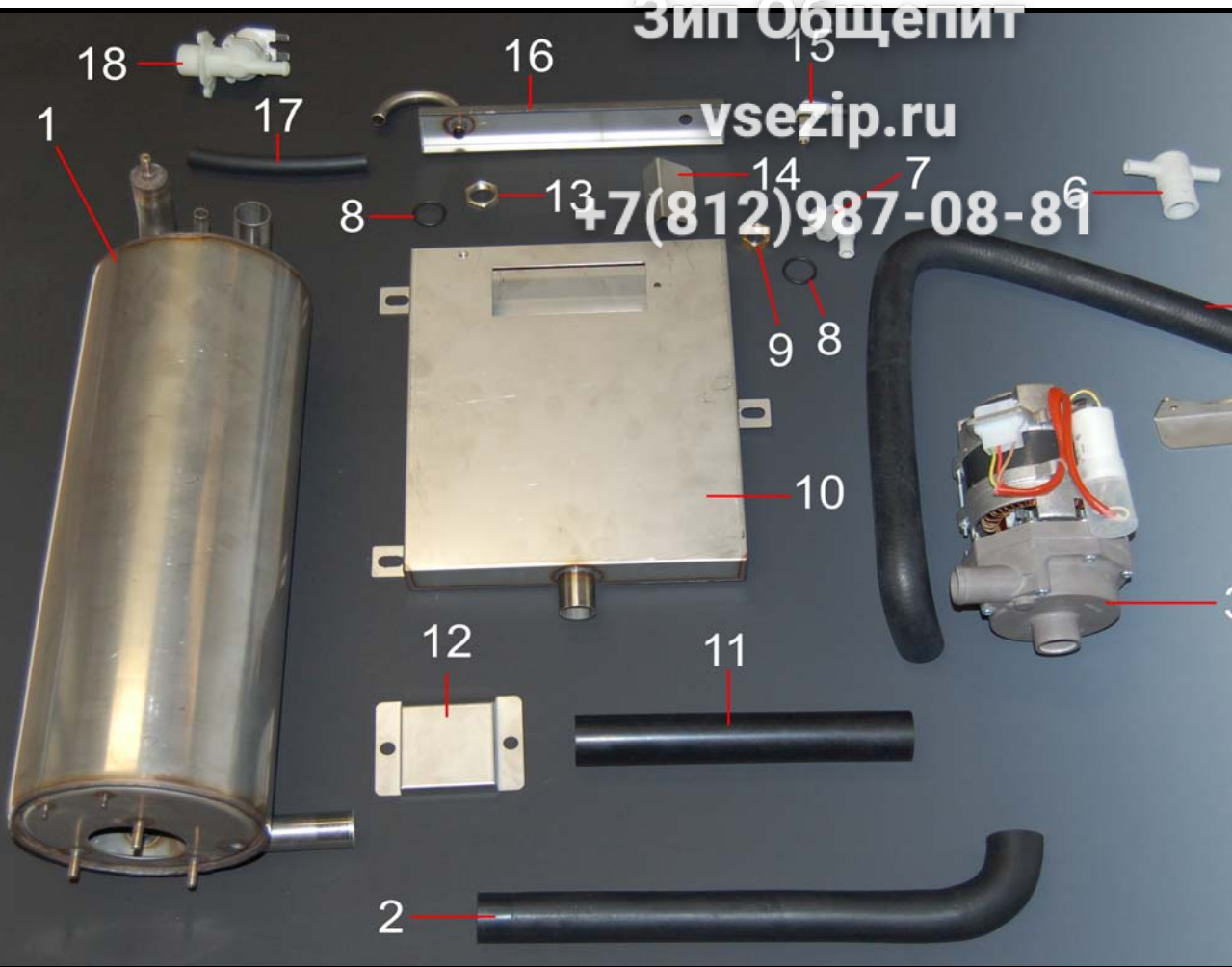

Pos.	Codice	Descrizione	Description	De
1	GB4823FAB	Boiler tri air break 150x425mm	Boiler, 3-ph, ABS version	Surchaffeur ABS V
2	GAMA4AB	Manicotto aspirazione pompa air break	Rinse pump inlet hose, ABS	Joint aspirateur pom
3	ABPRF5213	Pompa aumento pressione	Rinse pump, ABS	Pompe hausse pre
4	ABSTFP5213	Staffa inox pompa air break	Mounting bracket for rinse pump, ABS	Joint inox pompe
5	GRMP4AB	Manicotto mand. risc. air break	Rinse pump outlet hose, ABS	Manchon refoleme
6	ABRTRP	Raccordo "t" risc.con pompa	Tee connector, ABS	Raccord "t" rinçage
7	GRS06B	Raccordo fissaggio asta	Inlet elbow	Raccord
8	OR128	Or 128	O ring 128	Joint 128
9	D038A	Dado 3/8" gas ottone alto	Brass lock nut 3/8"	Ecrou 3/8"
10	ABSB46	Serbatoio inox air break	ABS tank, Steel	Cuve inox air break
11	ABMSB4	Manicotto tra serbatoio e boiler air break	ABS tank exit hose	Manchon entre cuve e
12	ABDFIV	Deflettore inox interno vasca air break	Protection plate for ABS wash tank	Deflecteur inox cuv
13	ABDFSB	Dado inox m20x1 fissaggio serbatoio AB	Nut, steel, M20 x 1	Ecrou 20x1
14	ABDFISB	Deflettore inox interno serbatoio air break	Deflector plate for ABS tank	Deflecteur inox cuv
15	DSDET040BC	Iniettore detersivo	Soap elbow assy	Produit lessiviel cor
16	ABCSB	Coperchio inox interno serbatoio air break	Top cover for ABS tank	Bouchon inox cuve
17	TG1118WRC	Tubo diam. 11x18mm "wrc"	Internal supply tube, 11x 18	Tuyau 11x18 mm "
18	CEEV1	Elettrovalvola 1 via	Solenoid valve, 1-way	Electrovanne 1 voi

Зип Общепит

vsezip.ru

+7(812)987-08-81

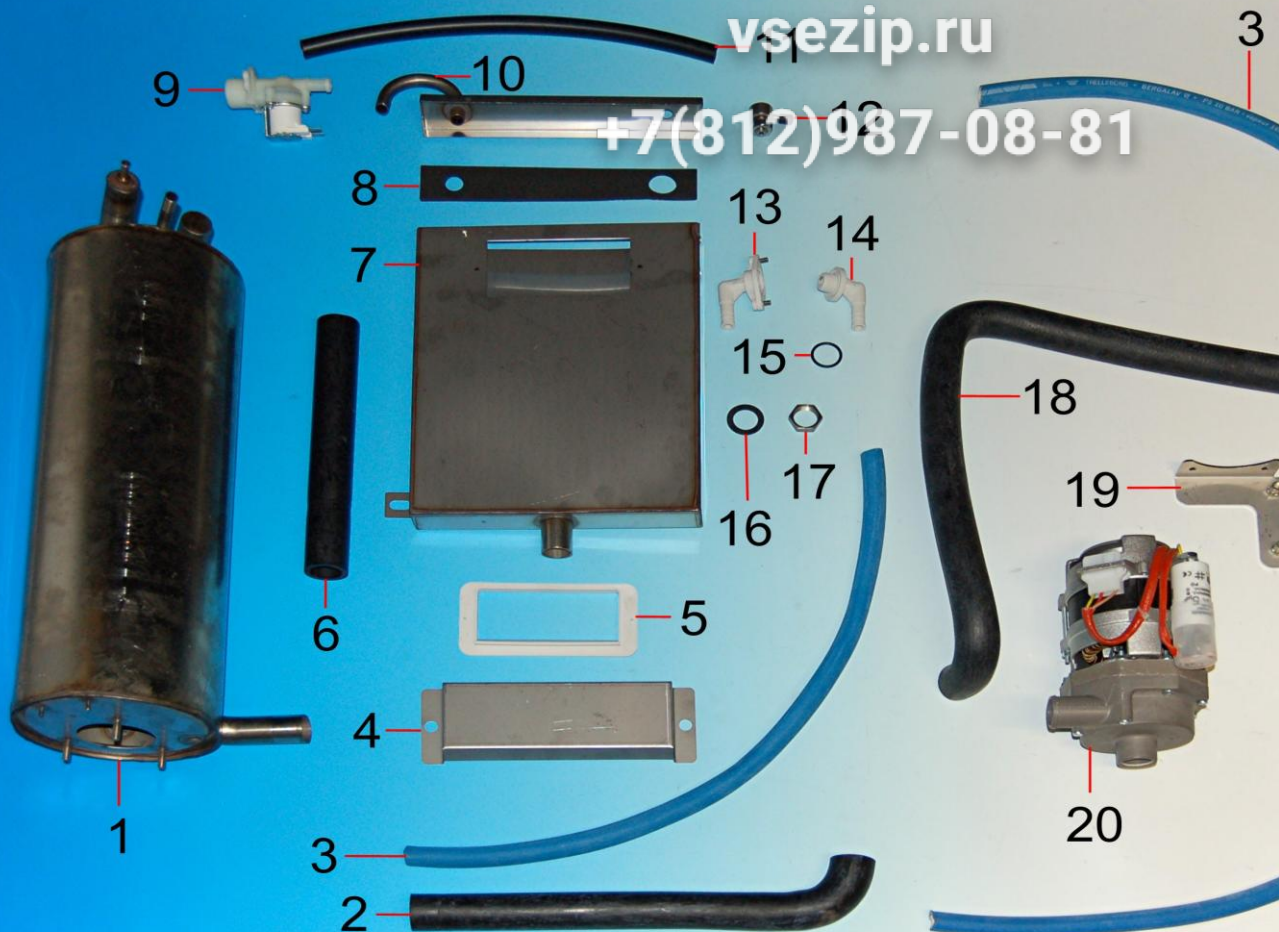

Pos.	Codice	Descrizione	Description	De
1	GB4823FAB	Boiler tri air break 150x425mm	Boiler, 3-ph, ABS version	Surchauffeur ABS V
2	GAMA4AB	Manicotto aspirazione pompa air break	Rinse pump inlet hose, ABS	Joint aspirateur pom
3	TG1117FDA	Tubo diam. 11x17 "fda"	Tube diam. 11x17 "fda"	Tuyau 11x17 "fda"
4	ABDFIV07	Deflettore inox vasca air break (2007)	Protection plate for ABS wash tank (2007)	Deflecteur inox cuv
5	ABCSAB46	Cornice serbatoio	Door handle, AB, 69 x140	Entourage cuve inc
6	ABMSB4	Manicotto tra serbatoio e boiler air break	ABS tank exit hose	Manchon entre cuve e
7	ABSB4607	Serbatoio inox air break (2007)	ABS tank, Steel (2007)	Cuve inox air break
8	ABGCSAB34229	Guarnizione 34x229x3 serbatoio air break	Seal, air break tank	Joint pour cuve ino
9	CEEV1	Elettrovalvola 1 via	Solenoid valve, 1-way	Electrovanne 1 voi
10	ABCSB	Coperchio inox interno serbatoio air break	Top cover for ABS tank	Bouchon inox cuve
11	TG1118WRC	Tubo diam. 11x18 "wrc"	Internal supply tube, 11x 18	Tuyau 11x18 mm "
12	GSEDETP10COMP	Iniettore inox completo	Soap Inlet Elbow Assembly	Injecteur inox comp
13	ABRISAB46	Raccordo interno serbatoio	Tube elbow adptor	Raccord int. cuve
14	ABRESAB46	Raccordo esterno serbatoio	Tube elbow adptor	Raccord est. cuve
15	OR128	Or 128	O ring 128	Joint 128
16	ABGSB203015	Guarnizione 30x20x1,5 serbatoio air break	Seal, air break tank	Joint pour cuve inc
17	ABDFSB	Dado inox m20x1 fissaggio serbatoio AB	Nut, steel, M20 x 1	Ecrou 20x1
18	GRMP4AB	Manicotto mand. risc. air break	Rinse pump outlet hose, ABS	Manchon refouleme
19	ABSTFP5213	Staffa inox pompa air break	Mounting bracket for rinse pump, ABS	Joint inox pompe
20	ABPRF5213	Pompa aumento pressione	Rinse pump, ABS	Pompe hausse pre
21	ABRTRP	Raccordo "t" risc.con pompa	Tee connector. ABS	Raccord "t" rincac

Зип Общежит

vsezip.ru

+7(812)987-08-81

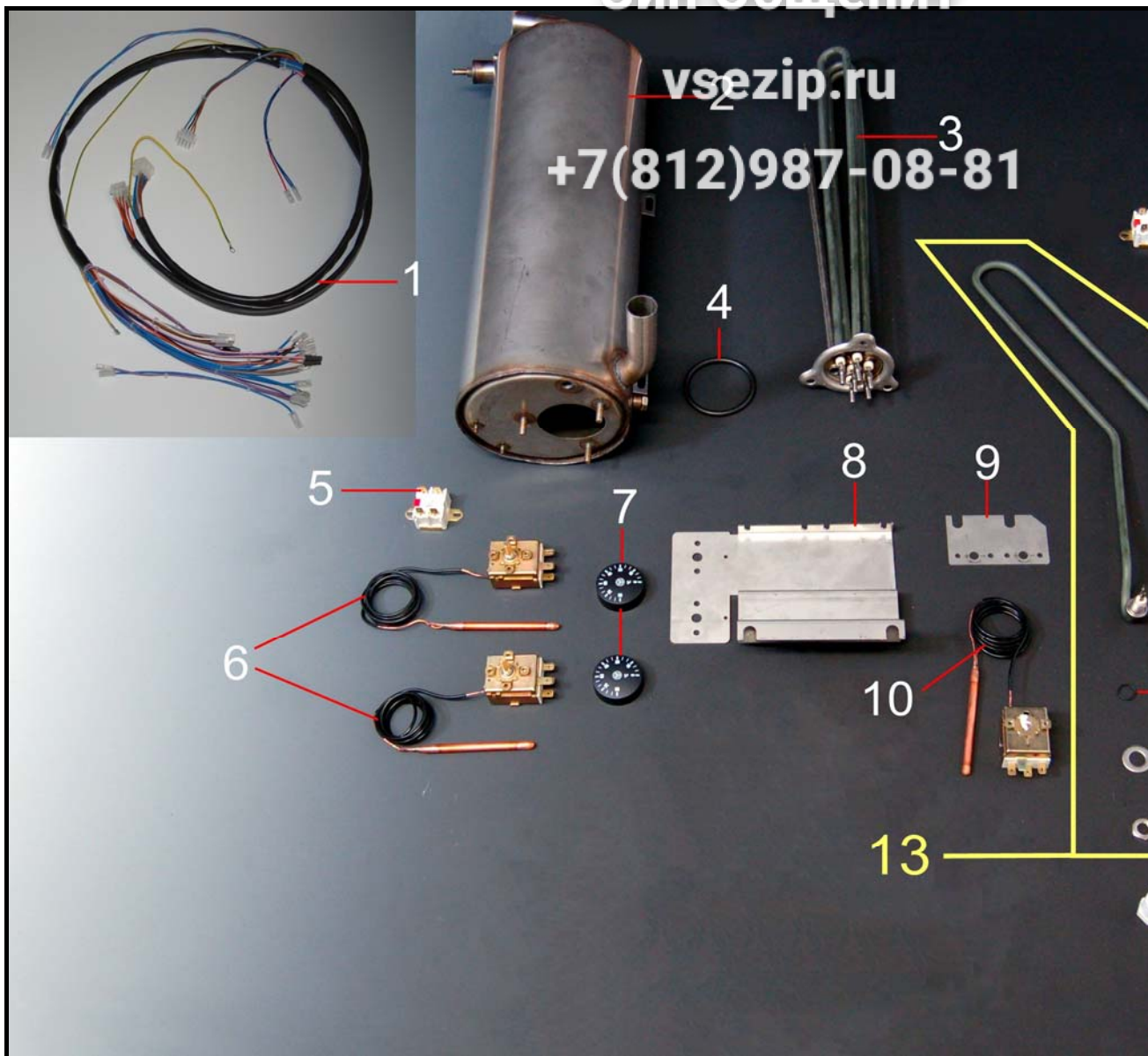

Pos.	Codice	Descrizione	Description	De
1	CECBI482AB	Cablaggio inferiore air break	Lower wiring loom, Air Break	Cable inférieur Air
2	GB4823FAB	Boiler trifase air break	Boiler, 3-ph, Air Break System version	Surchauffeur Air Br
3	CERB603F	Resistenza boiler 6000W	Rinse element 6.0 kW	Résistance surchauf
4	ORRB3F	Or resistenza boiler	O ring for rinse element	Joint pour résistanc
5	CESB454	Termostato sicurezza boiler	Safety switch, boiler	Termostat sécurité
6	CETB85	Termostato boiler regolabile	Boiler control thermostat	Termostat surchauff
7	CEMTB	Manopola termostati	Thermostat knob	Manette thermostat
8	AM0SQFTDE46AB	Squadretta fissaggio dosatori	Bracket for chemical pumps	Plaque fixation dosa
9	AM0SQTB	Squadretta fissaggio termostati	Bracket for thermostats	Plaque fixation therm
10	CETV55	Termostato vasca	Fixed wash control thermostat	Termostat cuve
11	CESV001	Termostato sicurezza vasca	Safety switch, wash tank	Termostat sécurité
12	AM0SQFRV4	Squadretta fissaggio resistenza vasca	Retaining clip for wash element	Plaque fixation résis
13	CERV22	Resistenza vasca 2200W	Wash element complete, 2.2kW	Resistance de la cu
14	ORRV	Or 12x1 resistenza vasca	O rings for wash element	Joint pour résistanc
15	VRP12I	Rondella piana diam. 12mm	Washer for wash element, diam. 12 mm	Rondelle diam 12 m
16	VDRV	Dado resistenza vasca	Nut for wash element	Ecrou fixation résista

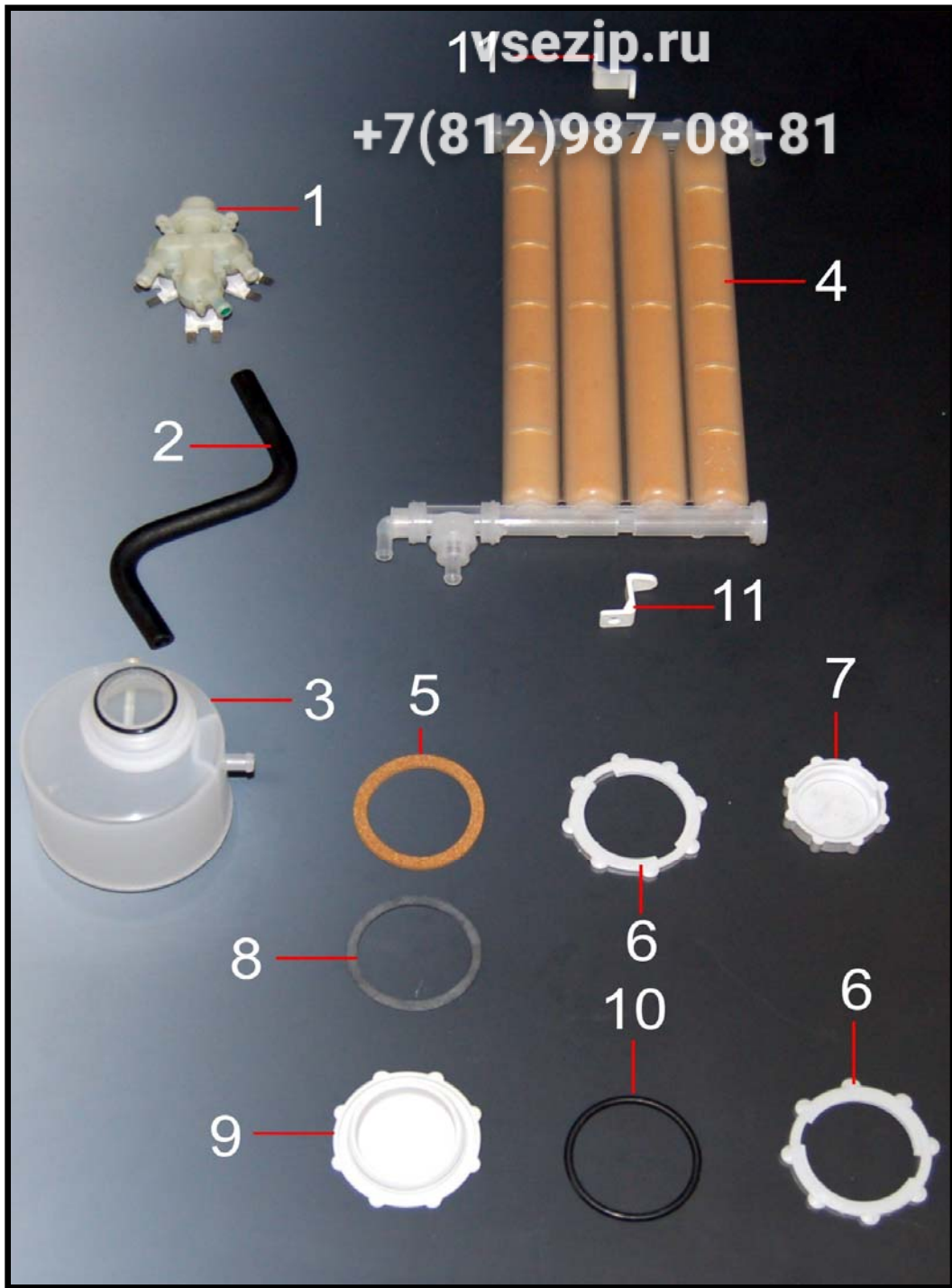

1vsezip.ru

+7(812)987-08-81

Pos.	Codice	Descrizione	Description	De
1	CEEV3	Elettrovalvola 3 vie 220 volt	Solenoid valve, 3-way - 220 v	Electrovanne 3 voie
2	DS327	Tubo sagomato grande	Injector operating hose, big	Tuyau caoutch, gra
3	CERI43	Contenitore sale	Salt chamber	Bac à sel
4	CERI47	Decalcificatore a resine	Water softener	Adoucisseur
5	CERI44GS	Guarnizione sughero 83x67x5	Cork seal washer for salt chamber	Joint 83x67x5
6	CERI45	Ghiera contenitore sale	Lock nut for salt chamber	Ecrou pour bac à s
7	CERI46	Tappo contenitore sale	Cap, thick salt chamber	Bouchon pour ba

Зип Общежит

vsezip.ru

+7(812)987-08-81

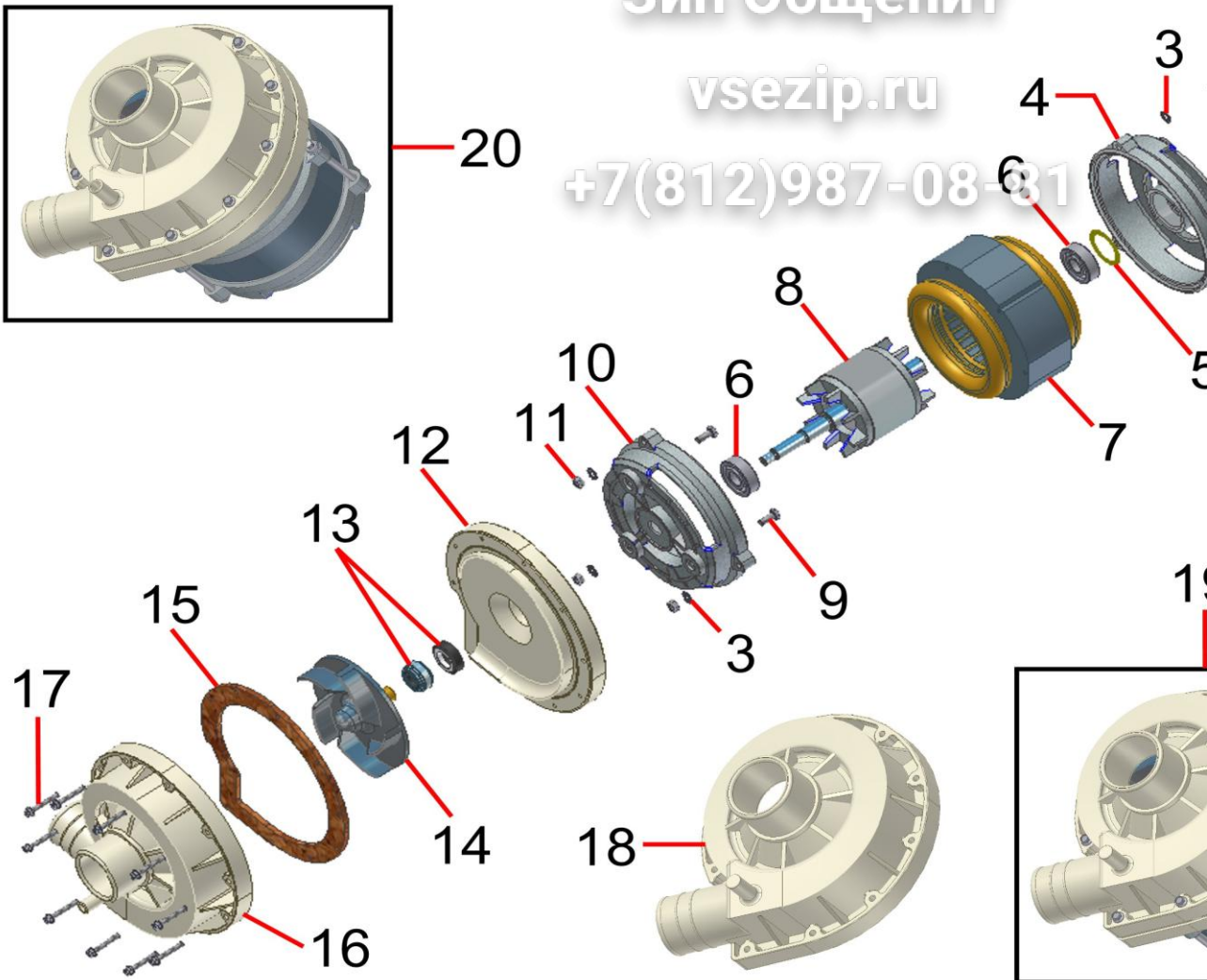

Pos.	Codice	Descrizione	Description	De
1	VVTE580Z	Vite TE 5x80	Special screw for motor assy, 5x80	Vis 5x80
2	VVTE570Z	Vite TE 5x70	Special screw for motor assy, 5x70	Vis 5x70
3	VR5I	Rondella dentata diam 5	Special tab washer	Rondelle éventailé
4	EP05M5	Calotta alluminio (filettata)	Motor endplate NDE	Calotte aluminium
5	EP011	Anello compensazione pompe	Bearing ring	Boucle compensati
6	EP07	Cuscinetto per motore pompa	Motor bearing	Roulement pour m
7	EP7510	Statore avvolto	Stator	Stator pompe
8	EP7589	Rotore con albero	Rotor	Rotor de compress
9	VVTE512I	Vite 5x12	Special screw	Vis 5x12
10	EP05	Calotta alluminio	Motor endplate DE	Calotte aluminium
11	VD5I	Dado esagonale m 5	Special hexagon nut	Ecrou M5
12	EP755TP	Fondo pompa grande	Impellor back plate	Fond pompe
13	EP04	Anello tenuta	Rotating shaft seal	Presse étoupe
14	EP753	Girante pompa grande	Impellor	Turbine de pompe
15	EP752NT	Guarnizione pompa	Cork gasket	Joint pompe
16	EP751TP	Corpo pompa grande aperto	Impellor housing, open nipple	Corps pompe 1hp
17	VATE4232Z	Vite autofilettante 4,2x32	Special screw	Vis 4,2x32
18	EP751TPC	Corpo pompa grande chiuso	Impellor housing, closed nipple	Corps pompe 1hp,
19	EP100C	Elettropompa 1hp 230v 50hz chiusa	Wash pump complete, closed nipple	Pompe de lavage

Зип-Общепит

vsezip.ru

+7(812)987-08-81

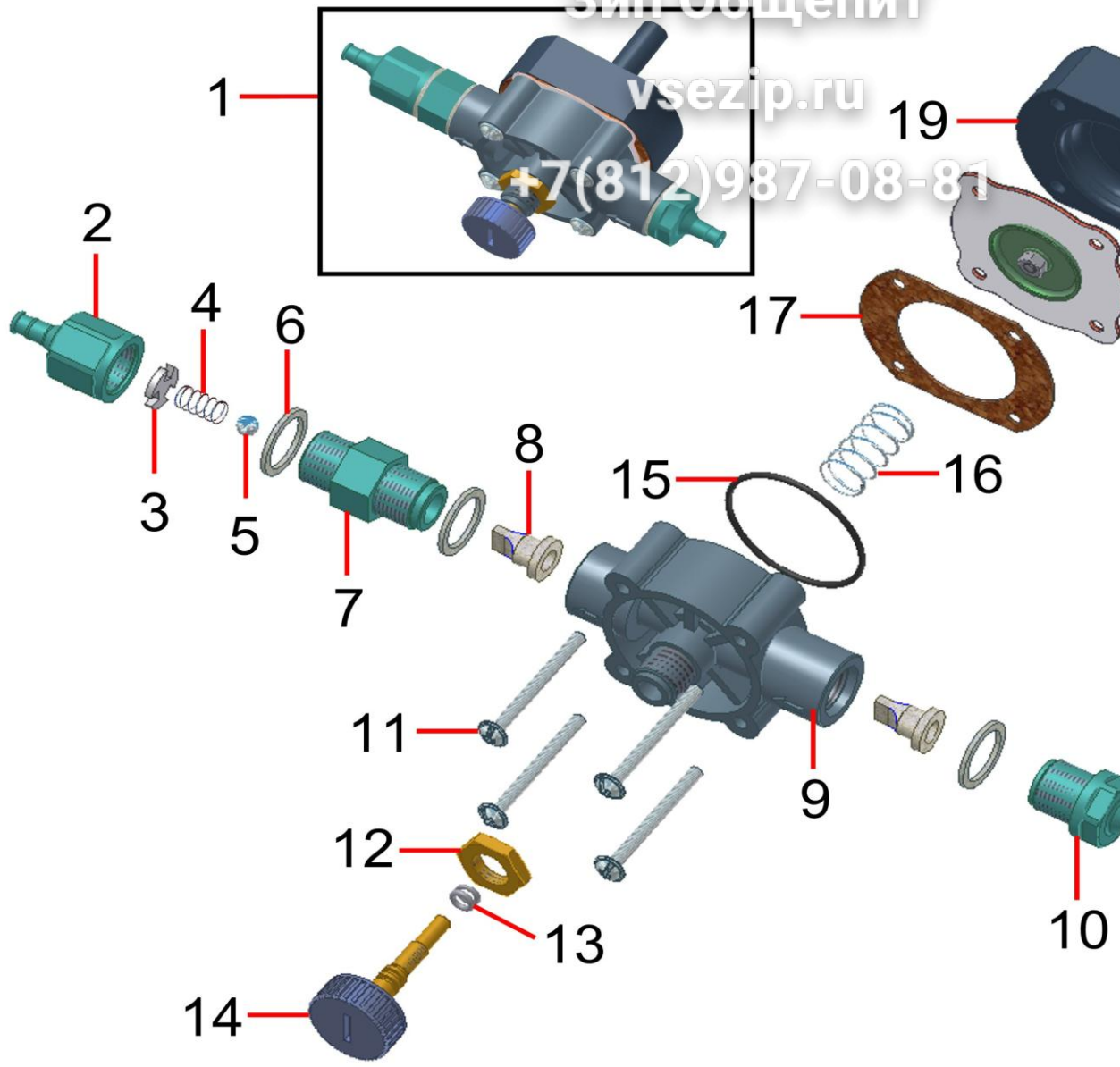

Pos.	Codice	Descrizione	Description	De
1	DSAM3NT	Dosatore brillantante completo assemblato	Rinse aid injector, complete	Doseur produit de r
2	DSVNR17NT	Raccordo stringitubo valvola non ritorno	Outlet nipple	Raccord clapet anti
3	DSVNR16	Dischetto valvola non ritorno	Special disk for non return valve	Petit disque clapet
4	DSVNR14	Molla valvola non ritorno	Spring for non return valve	Ressort clapet anti
5	DSVNR13	Sfera 1/4"	1/4" Ball for non return valve	Bille 1/4"
6	G16221F	Guarnizione fibra 17x22x1,5	Seal for injector	Joint pour injecteur
7	DSVNR12	Raccordo valvola non ritorno	Housing for non return valve	Raccord soupape
8	DS8S	Valvolina silicone	Non return valve, rubber	Soupape en silicon
9	DS3	Corpo dosatore	Injector front body	Corps doseur produ
10	DS10NT	Raccordo stringitubo	Inlet nipple	Raccord
11	VVTCC445Z	Vite fissaggio	Special screw	Vis serrage
12	DS24	Dado 20x4x14	Brass nut 20x4x14	Ecrou 20x4x14
13	OR103	Or 103	O ring 103	Or 103
14	DS1	Volantino dosatore	Adjusting screw	Manette pour dose
15	OR422	Or 42x2	O ring 42x2	Or 42x2



Зип Общепит

vsezip.ru

+7(812)987-08-81

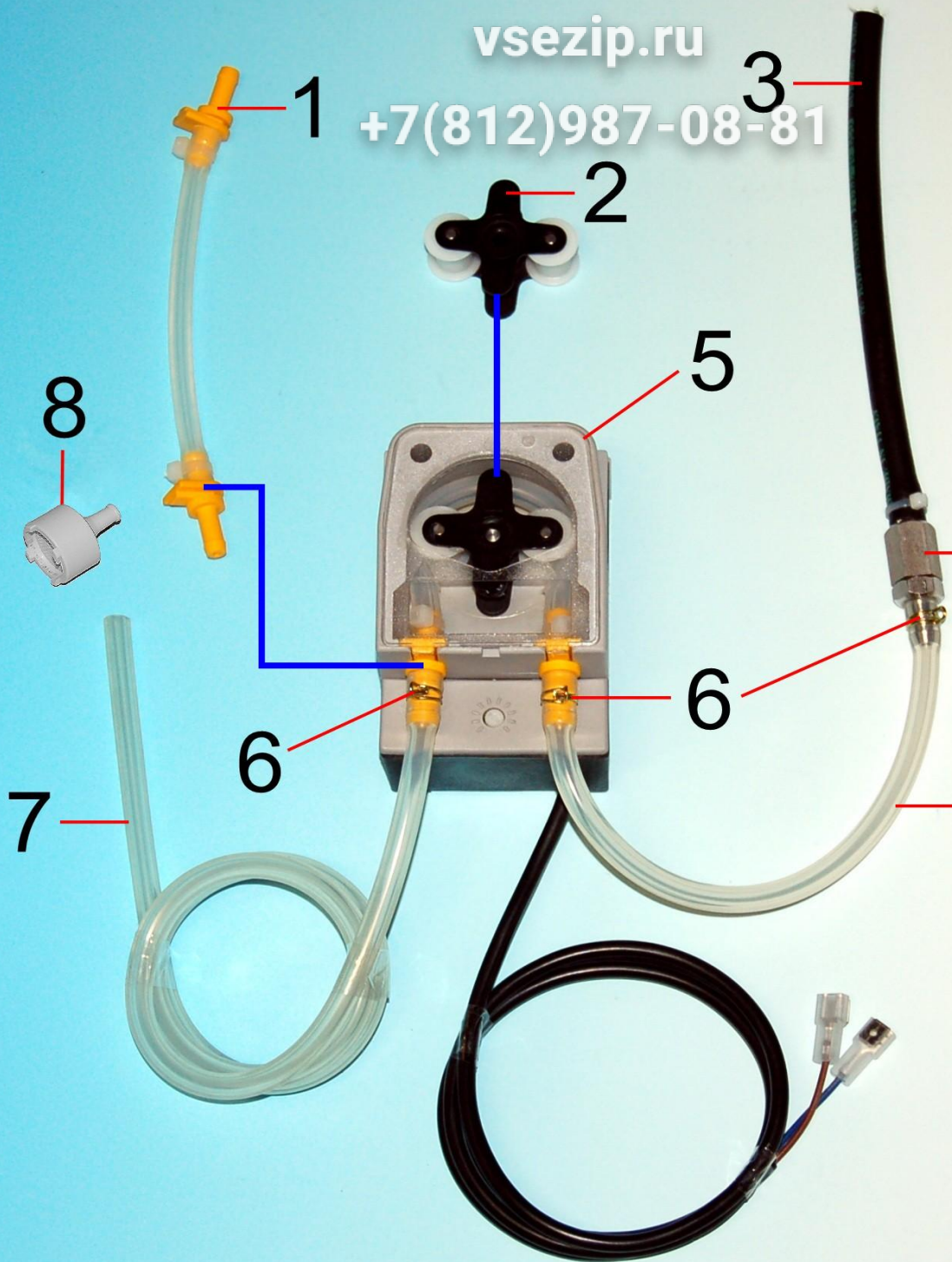

Pos.	Codice	Descrizione	Description	De
1	D0STSILSKC	Tubo silicone brillantante+attacchi	Peristaltic rinse aid tube with fittings	Tube silicone dose
2	D0SPRRSKC	Portarullini peristaltica seko	Rotating pump head, rinse aid	Rotor
3	TG510DS	Tubo dosatore 5x10	Rinse aid tube to boiler	Tube doseur 5x10

vsezip.ru

+7(812)987-08-81

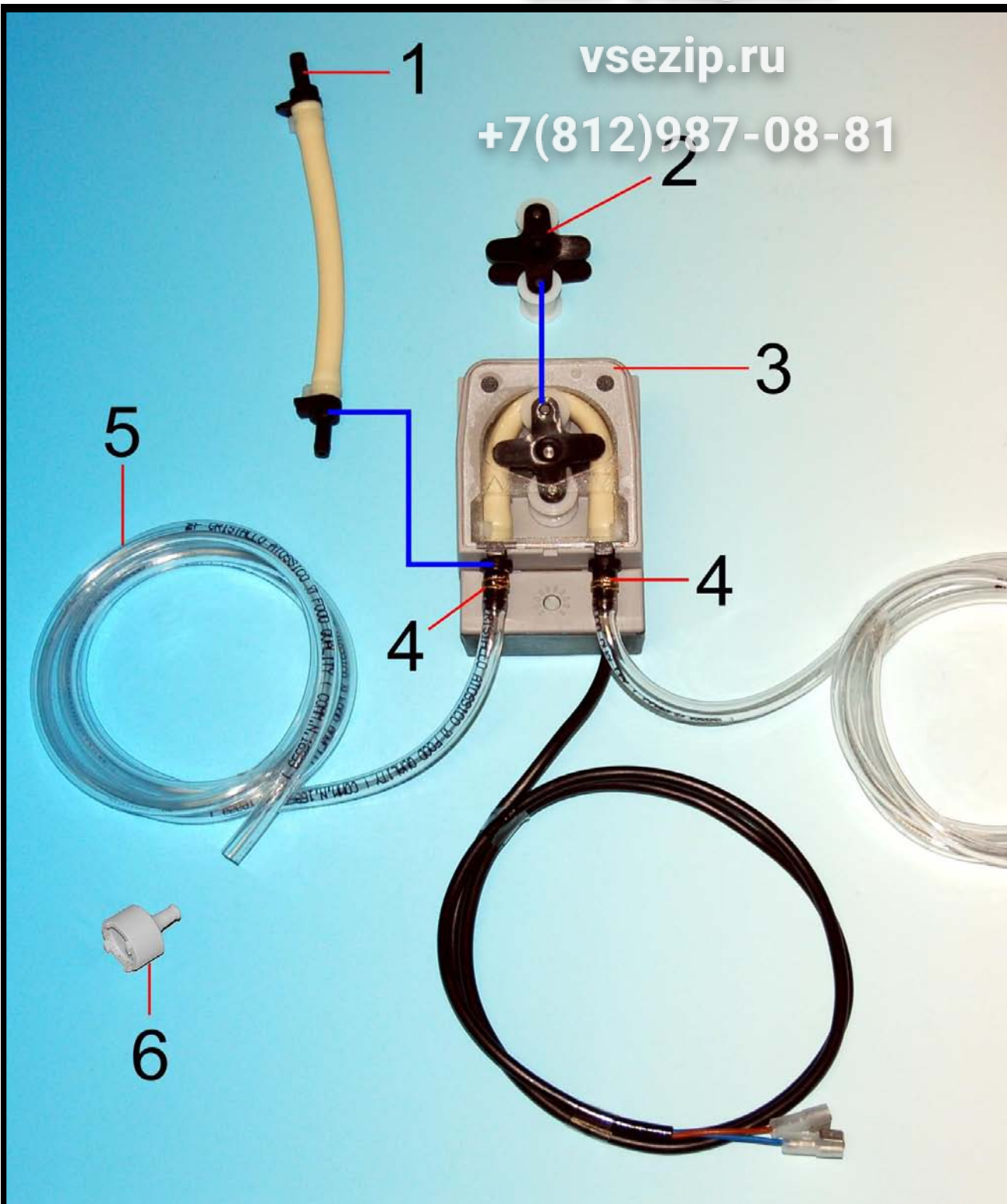

Pos.	Codice	Descrizione	Description	De
1	D0STSANSKC	Tubo Santoprene detergente+attacchi	Peristaltic soap tube with fittings	Tube Santoprene d
2	D0SPRRSKC	Portarullini peristaltica seko	Rotating pump head, soap	Rotor
3	D0SDETETLE	Dosatore detergente "eur"	Soap pump	Doseur produit de l
4	FAM710	Fascetta a molla	Spring clip for tubing	Collier
5	T050	Tubo peristaltico	Peristaltic tube	Tubo peristaltico
6		Collier	Spring clip	Collier

HANDLES

Зип Общепит

vsezip.ru

+7(812)987-08-81



1



2



3



4



5



6



7

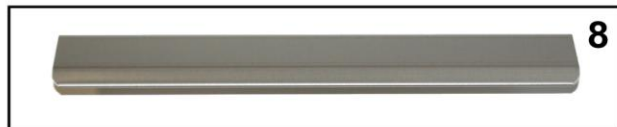

8



18



17



16



15



14



13



12



9



10

Pos.	Codice	Descrizione	Description	De
1	AM010GBGR	Maniglia grigia	Handle, grey	Poignée porte grise
2	AM010SIM	Maniglia blu	Handle, blue, closed grip, rectangular	Poignée porte , ble
3	AM010PA	Maniglia aperta nera	Handle, black, thru grip, angled	Poignée porte noire
4	AM010PCV	Maniglia chiusa verde	Handle, green, closed grip, curved	Poignée porte vert
5	AM010MD25	Maniglia chiusa ovale blu	Handle, blue, thru grip, oval	Poignée porte oval
6	AM010CD25	Cornice sottomaniglia blu	Handle backplate, blue, oval	Entourage sous-po
7	AM010F	Maniglia curva inox	Handle, Stainless steel, round section	Poignée porte cour
8	AM010R	Maniglia poligonale inox	Handle, Stainless steel, angled section	Poignée porte inox
9	VVSP6100	Vite maniglia	Screw, door handle fixing	Vis pour poignée p
10	OR106	Or per vite maniglia	O-Ring, door handle screw	Joint torique pour p
11	VD6I	Dado M6	Nut, M6	Ecrou, M6
12	AM010SMH	Cornice sottomaniglia nero	Handle backplate, rectangular	Entourage sous-po
13	AM010CD25GR	Cornice sottomaniglia grigia	Handle backplate, grey, oval	Entourage sous-po
14	AM010MD25GR	Maniglia chiusa ovale grigia	Handle, grey, thru grip, oval	Poignée porte grise
15	AM010SW	Maniglia chiusa nera	Handle, black, thru grip, double curved	Poignée porte noir

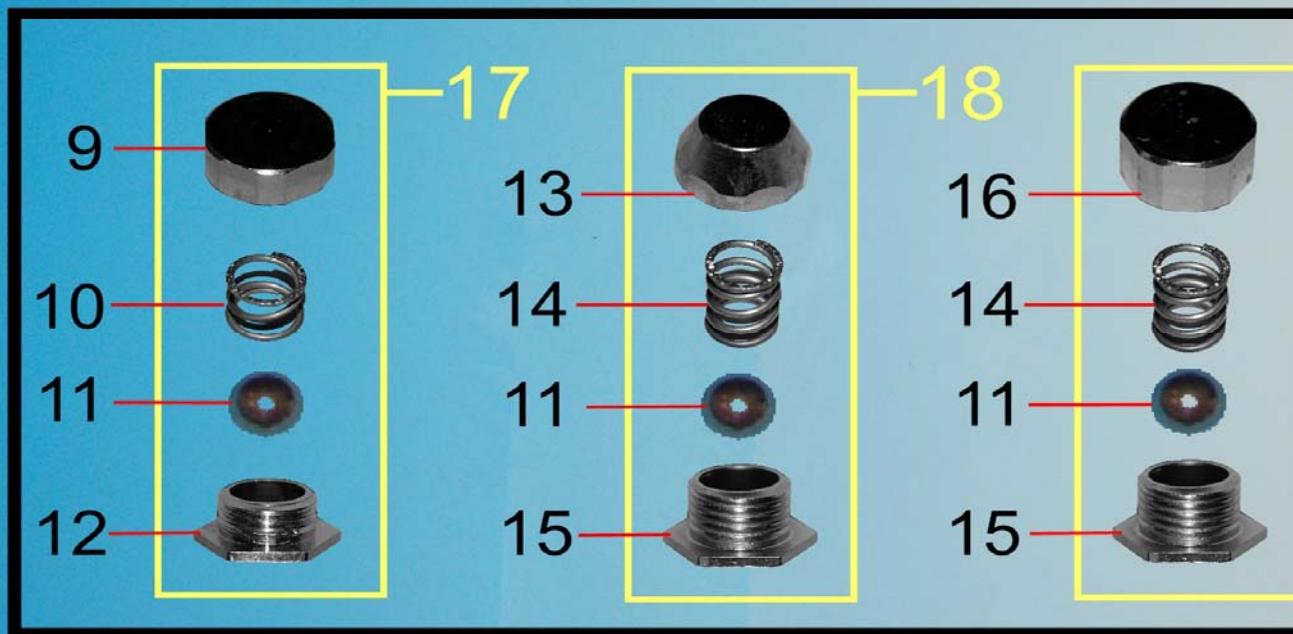

Pos.	Codice	Descrizione	Description	Des
1	GMDP2	Deflettore porta 40x40*50x50	Door deflector 40x40*50x50	Deflecteur porte 40
2	AM014B	Angolare vasca	Plastic corner guard	Cornière exterieure
3	AMPCP	Paracolpo porta	Door stop	Pare-chocs
4	AMMP24DX	Molla destra per porta mod. 50x50	Door spring, rh model 50x50	Ressort droit porte
5	AM412NTM	Perno porta modello 50x50	Door pin spacer model 50x50	Axe de la porte mo
5A	AM012M	Distanziale	Door pin spacer	Entretoise
6	AMMP24SX	Molla sinistra per porta mod. 50x50	Door spring, lh model 50x50	Ressort gauche po
7	VVEI410I	Vite tce m4x10	Screw m4x10	Vis m4x10
8	AM0PFPPM	Piastrina fissaggio perno porta	Pin security plate	Plaquette fixation piv
9	AM011ANT	Dado scroccetto vasca doppia parete	Ball catch nut	Bouchon de la bille
10	AM011CNT	Molla scroccetto doppia parete	Ball catch spring	Ressort inox, doubl
11	AM011D	Sfera scroccetto	Ball catch ball	Bille inox
12	AM011ENT	Sede sfera scroccetto doppia parete	Door ball catch seat	Siège ressort inox,
13	AM011AR	Dado scroccetto vasca raggiata	Ball catch nut	Bouchon de la bille
14	AM011C	Molla scroccetto	Ball catch spring	Ressort inox

Зип Общепит

vsezip.ru

+7(812)987-08-81

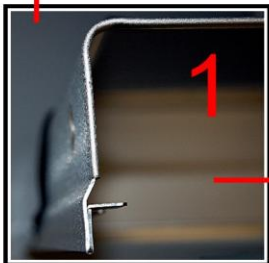
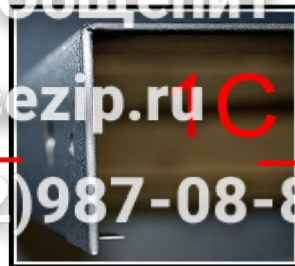
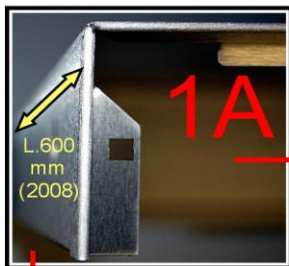

Pos.	Codice	Descrizione	Description	De
1	GMPS5RDP	Pannello superiore "raggiato"	Top panel, steel	Panneau superieur
1A	GMPS5PR508	Pannello superiore L. 600 mm (2008)	Top panel, steel L. 600 mm (2008)	Panneau superieur inc
1B	GMPS5PR5	Pannello superiore L. 570 mm	Top panel, steel L. 570 mm	Panneau superieur
1C	GMPS5SIMPR5	Pannello superiore	Top panel, steel	Panneau superieur
1D	GMPS5N0S	Pannello superiore	Top panel, steel	Panneau superieur
2	GMVA5RPR5	Vasca raggiata	Wash cabinet	Cuve
2A	GMVA5PR5	Vasca quadra	Wash cabinet	Cuve
3	GMGC5DXINT	Guida supporto cestello destra	Basket ramp, RH	Support panier droi
4	GMGC5SXINT	Guida supporto cestello sinistra	Basket ramp, LH	Support panier gau
5	GMBA5PR5	Basamento	Base	Socle

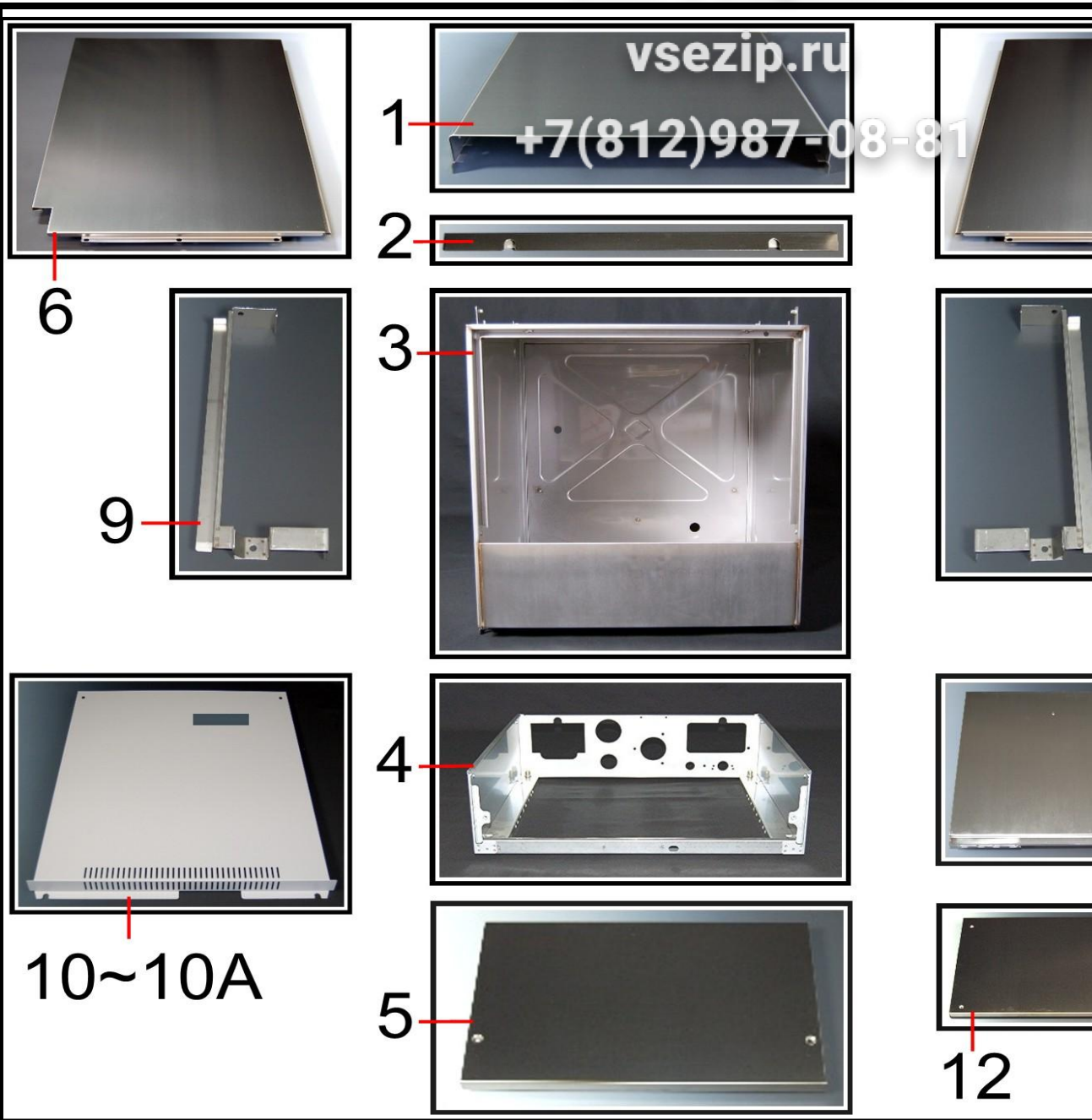

Pos.	Codice	Descrizione	Description	De
1	GMPS5DP	Pannello superiore	Top panel	Panneau superieur
2	AMPV4DP	Profilo vasca doppia parete	U section,cabinet	Profil cuve
3	GMVA5DSGB	Vasca doppia parete	Wash cabinet, ABS version	Cuve, double paroi
4	GMBA5DSGB	Basamento doppia parete	Base, ABS version	Socle, double paro
5	GMCR5DSGB	Cruscotto doppia parete	Front panel, ABS version	Panneau socle inox
6	GMPL5SXDS	Pannello laterale sinistro doppia parete	Side panel, LH	Panneau latéral ga
7	GMPL5DXDS	Pannello laterale destro doppia parete	Side panel, RH	Panneau latéral dro
8	GMGC5DXIDS	Guida destra doppia parete	Basket ramp, RH	Guide droite
9	GMGC5SXIDS	Guida sinistra doppia parete	Basket ramp, LH	Guide gauche
10	GMPP5DSGB	Pannello posteriore doppia parete	Back panel	Panneau postérieur
10A	GMPP5DSGB07	Pannello posteriore air break (2007)	Back panel air break (2007)	Panneau postérieur

Зип Общепит

vsezip.ru

+7(812)987-08-81



Pos.	Codice	Descrizione	Description	De
1	GMCR5R	Cruscotto basamento inox con cava	Bottom panel, with rinse aid aperture, steel	Panneau socle inox
2	AM0TCBPLB	Tappo cava brillantante blu	Rinse aid insert, plastic panel, blue	Bouchon bleu
3	AM0TCBPLGR	Tappo cava brillantante grigio	Rinse aid insert, plastic panel, grey	Bouchon gris
4	AM0TCBPL	Tappo cava brillantante nero	Rinse aid insert, plastic panel, black	Bouchon noir
5	AM029	Spina contenitore brillantante	Securing rod, rinse aid insert	Tige pour bouchon
6	AM030	Tappo contenitore brillantante	Cap for rinse aid reservoir	Bouchon pour bidon
7	AM027	Contenitore brillantante	Rinse aid reservoir	Bidon produit rinça
8	AM028N	Cornice nera	Rinse aid insert, steel panel, black	Entourage noir

Зип Общепит

vsezip.ru

+7(812)987-08-81

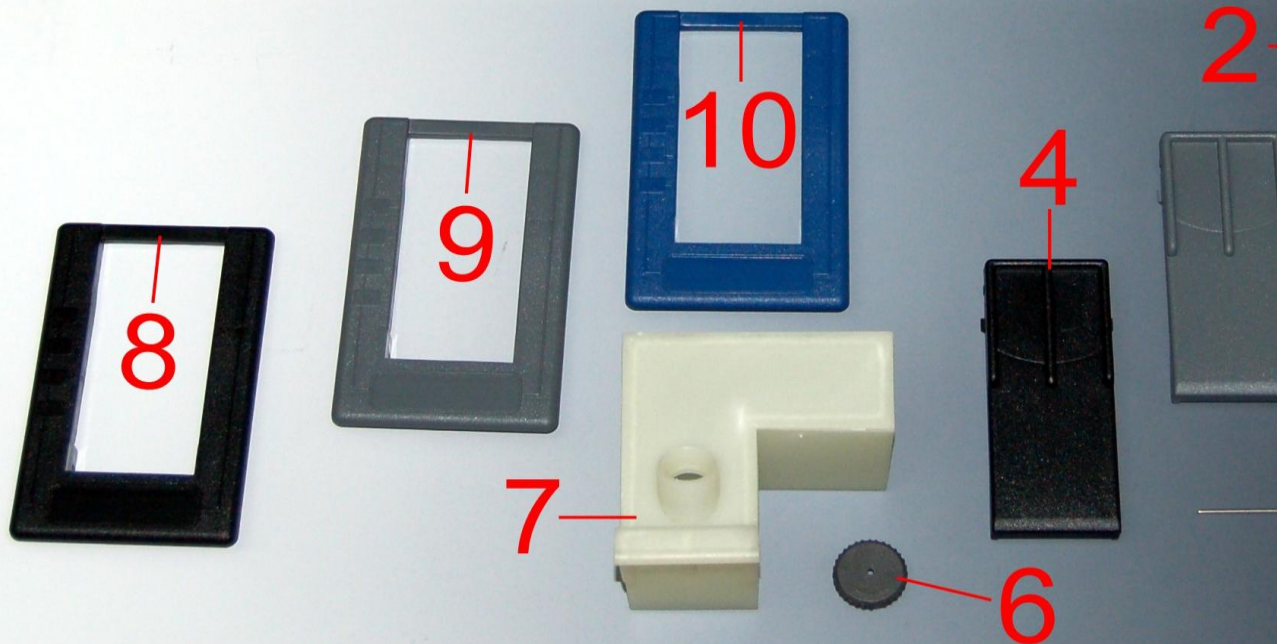

Pos.	Codice	Descrizione	Description	De
1	GMCR5	Cruscotto inox con cava	Bottom panel, steel, with aperture	Panneau socle inox
2	AM0TCBPLB	Tappo cava blu	Plastic cover for rinse aid opening, blue	Bouchon bleu
3	AM0TCBPLGR	Tappo cava grigio	Plastic cover for rinse aid opening, grey	Bouchon gris
4	AM0TCBPL	Tappo cava nero	Plastic cover for rinse aid opening, black	Bouchon noir
5	AM029	Spina fissaggio inox	Securing rod for rinse aid reservoir	Tige inox
6	AM030	Tappo contenitore brillantante	Cap for rinse aid insert	Bouchon pour bidon
7	AM027	Contenitore brillantante	Rinse aid reservoir	Bidon produit de rin
8	AM028N	Cornice anteriore nera	Rinse aid reservoir frame, black	Cadre antérieur noir



+7(812)987-08-81

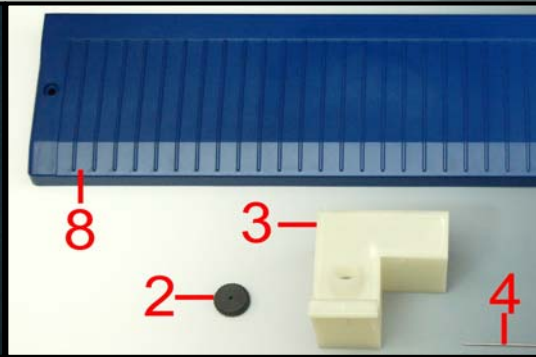
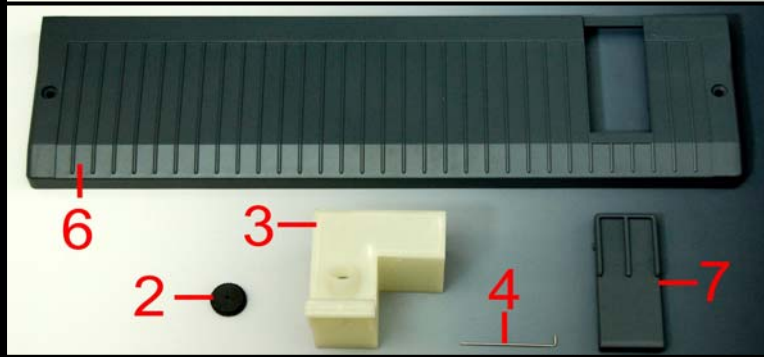
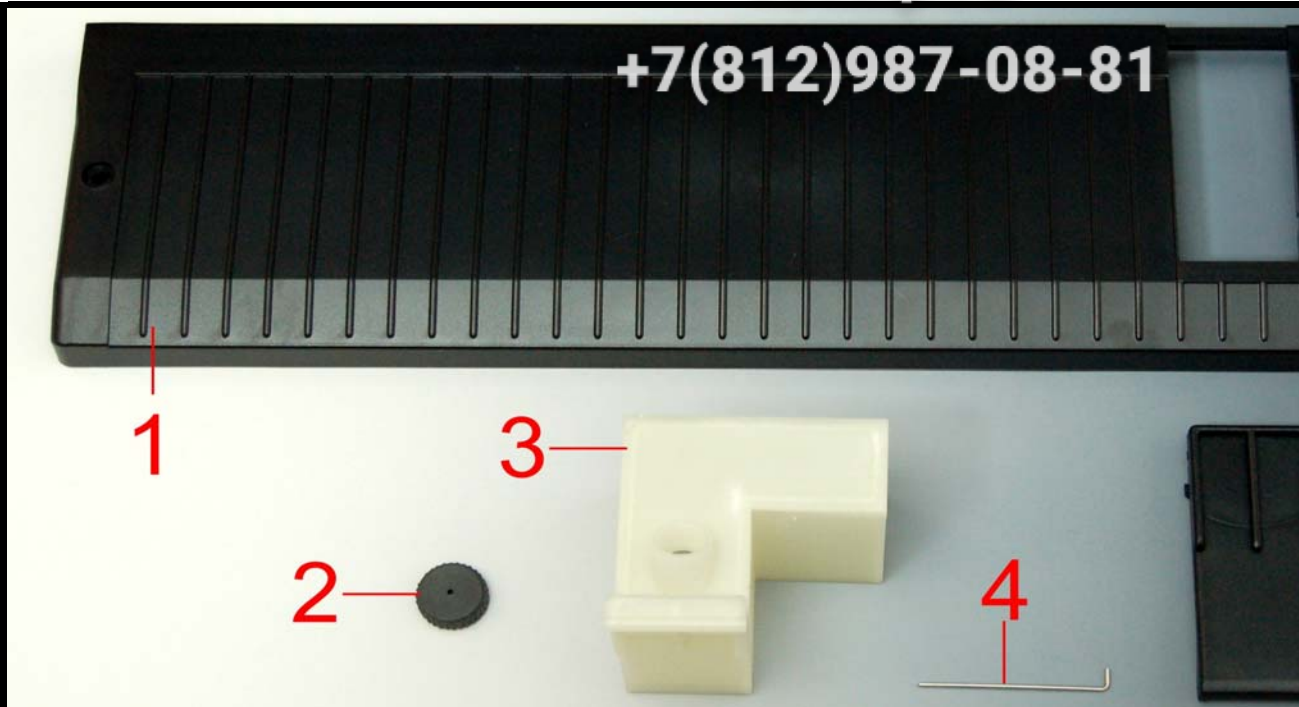

Pos.	Codice	Descrizione	Description	De
1	GMC5PL	Cruscotto nero	Bottom panel, plastic, aperture, black	Panneau socle plas
2	AM030	Tappo contenitore brillantante	Cap for rinse aid reservoir	Bouchon pour contene
3	AM027	Contenitore brillantante	Rinse aid reservoir	Cuve produit de rin
4	AM029	Spina fissaggio inox	Securing rod for rinse aid reservoir	Tige pour bouchon
5	AM0TCBPL	Tappo cava nero	Plastic cover for rinse aid opening, black	Bouchon noir
6	GMC5PLGR	Cruscotto grigio	Bottom panel, plastic, aperture, grey	Panneau socle plas
7	AM0TCBPLGR	Tappo cava grigio	Plastic cover for rinse aid opening, grey	Bouchon gris
8	GMC5PLBL	Cruscotto blu	Bottom panel, plastic, aperture, blue	Panneau socle plas
9	AM0TCBPLB	Tappo cava blu	Plastic cover for rinse aid opening, blue	Bouchon blue

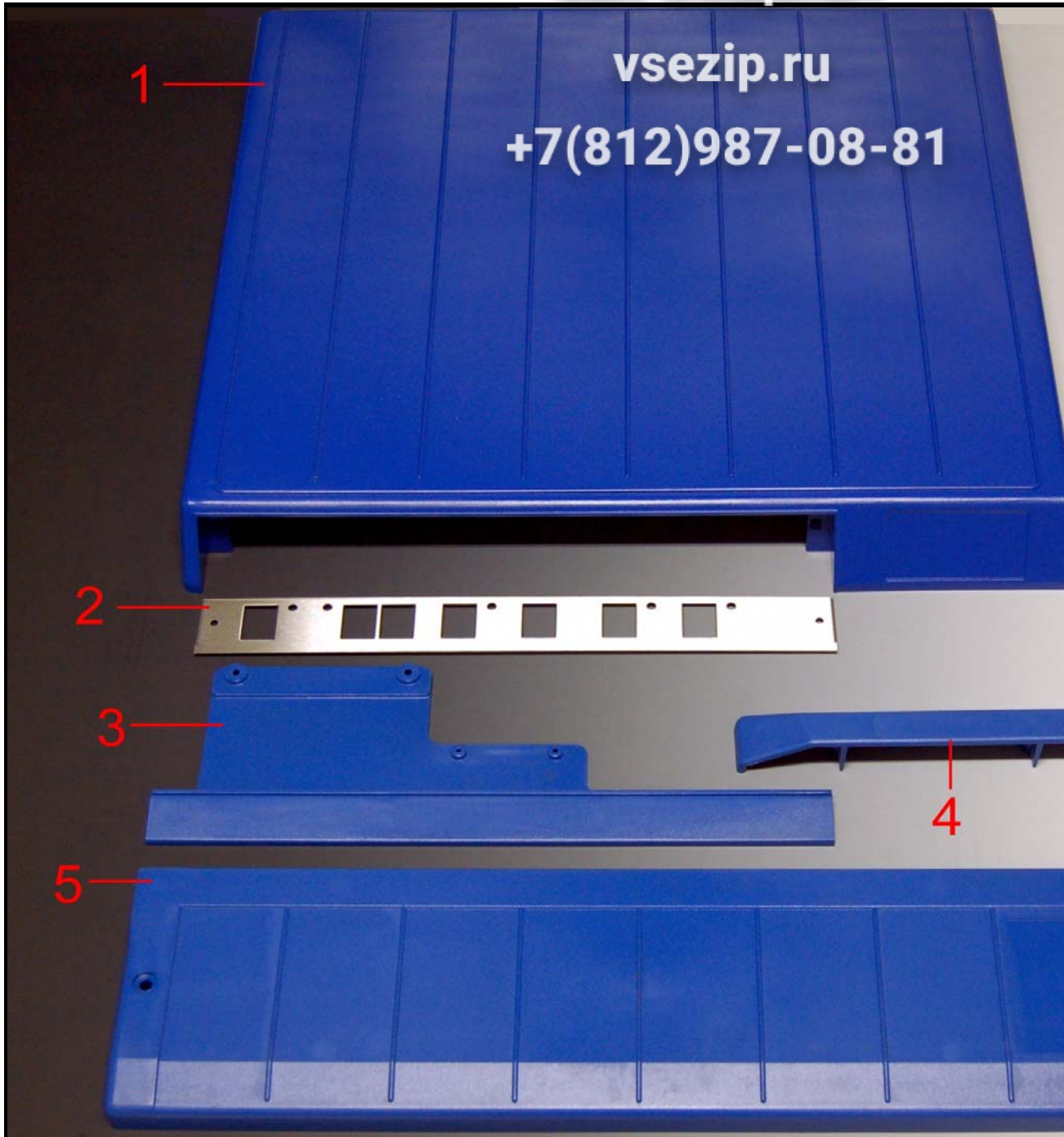

Pos.	Codice	Descrizione	Description	Des
1	GMPS5GBPL	Pannello superiore	Top panel	Panneau supérieur
2	GMPI4QC	Portainterruttori inox	Steel control panel	Porte-interrupteur i
3	GMTPI5GBPL	Telaio portainterruttori	Control panel insert	Chassis porte-inter
4	AM010GB	Maniglia	Door handle	Poigné
5	GMCR5GBPL	Cruscotto	Bottom panel	Panneau

Зип Общепит

vsezip.ru

+7(812)987-08-81

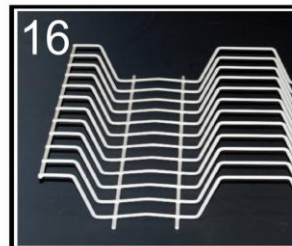
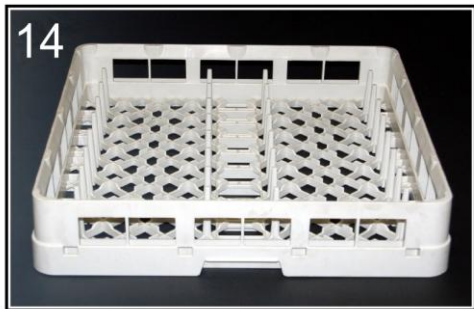

Pos.	Codice	Descrizione	Description	De
1	GS330	Tubo scarico Ø 31,5	Drain Pipe Ø 31,5	Flexible de vidange
2	TC3415	Tubo carico "vde" mt. 1,5	Water Supply Hose, 3/4" BSP, 1,5 m	Tube entrée eau "v
3	VDCVGB	Doppia valvola con tubo carico	Water Supply Hose+Dbl Chk Valve,1,5m	Double valve avec
4	GB055	Portagomma a "T" 2 vie	Double Tee Connector	Raccord à "T" 2
5	GB017	Portagomma a "T" 1 via	Tee Connector	Raccord à "T" 1
6	GB017NT	Portagomma a "L" 1 via	3 Way Connector	Raccord à "L" 1
7	CEEV1	Elettrovalvola 1 via 220 volt	Solenoid Valve, 1-Way, 230V	Electrovanne 1 voi
8	CEEV2	Elettrovalvola 2 vie 220 volt	Solenoid Valve, 2-Way, 230V	Electrovanne 2 voi
9	AM016C	Confezione 4 piedini lavastoviglie	Set of 4 adjustable feet dishwashers	Set nr.4 pieds lave
10	CTIP17	Inserto porta piattini 17 posti	Large saucer rack	Godet porte soucou
11	IP4PM	Inserto porta posate 4 posti con maniglia	Cutlery basket with handle	Godet porte couver
12	GSDETP10COMP	Iniettore inox completo	Soap Inlet Elbow Assembly	Injecteur inox comp
13	DSDET040BC	Iniettore completo	Soap Elbow Assy	Injecteur complet
14	CQ5018PPL	Cestello 50x50 18 piattini	Plate rack 500 square	Panier 50x50 18 as
15	CQ50RPL	Cestello 50x50 bicchieri	Glass rack 500 square	Panier 50x50 pou

**Зип Общепит**

**vsezip.ru**

**+7(812)987-08-81**



**0210/100.04**