



Зип Ощепит

vsezip.ru

Spare Parts for

+7(812)987-08781 **Combi Ovens**



Spare parts suitable for

GIORIK

2017

Find the complete and up-to-date range of products in our GEV Webshop

heating elements

immersion heating elements

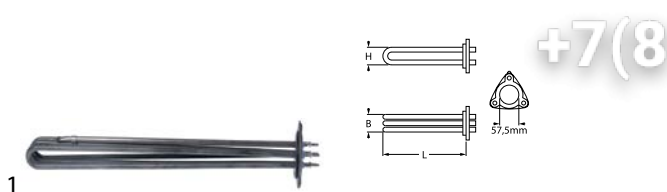

3 hole flange ø57.5mm



GEV No.	418085	Ref. No.	6003295
description	heating element 10000W 230V mounting ø 57.5mm heating circuits 3 L 393mm W 38mm H 52mm number of thermostat sleeves 1 thermostat sleeves ø 7mm length thermostat sleeves 350mm thermostat sleeve not clinging tube ø 8.5mm hole distance 73mm hole ø 8mm connection length 33mm connection M4 3 hole flange immersion heater		
For models:	VE20EC, VE20MX		
spare parts for	418085		
	GEV No.	510409	Ref. No. —
	O-ring EPDM thickness 5.34mm ID ø 56.52mm Qty 1 pcs		

	GEV No.	418084	Ref. No.	6003290
description	heating element 7599W 230V mounting ø 57.5mm heating circuits 3 L 340mm W 36mm H 42mm number of thermostat sleeves 1 thermostat sleeves ø 7mm length thermostat sleeves 270mm thermostat sleeve clinging tube ø 8.5mm hole distance 72mm hole ø 8mm connection M4 3 hole flange immersion heater			
For models:	EN10VE-EC-ESN1033, VE06EC, VE06MX, VE102EC, VE102MX, VE10EC, VE10MX			



heating elements for convection

	GEV No.	418087	Ref. No.	6002125
description	heating element 15000W 230/400V heating circuits 3 ID ø 398mm ED ø 415mm L 452mm H 121mm L1 32mm W1 105mm H1 80mm H2 25mm flange length 142mm flange width 25mm hole distance 126mm connection M4 tube ø 8.5mm convection heating element hole ø 6mm rectangular flange			
For models:	CE10MX, CE20MX, DE10EC, DE10ES, DE10MX, EF10GM, EF8PM, VE10EC, VE10MX, VE20EC, VE20MX			
accessories for	418087			
	GEV No.	550548	Ref. No.	2005173
	gasket L 144mm W 25.5mm thickness 2.2mm for heating element suitable for GIORIK equiv. no. 2005173			



Зип Общепит

vsezip.ru

+7(812)987-08-81

	GEV No.	418088	Ref. No.	6002121
description	heating element 25000W 400V heating circuits 3 ID ø 388mm ED ø 406mm L 452mm H 150mm L1 35mm W1 105mm H1 21mm H2 130mm flange length 142mm flange width 25mm hole distance 126mm connection M4 connection length 72mm tube ø 8.5mm convection heating element hole ø 6mm rectangular flange			
For models:	CE102MX, DE102EC, DE102MX, VE102EC, VE102MX			
accessories for	418088			
	GEV No.	550548	Ref. No.	2005173
	gasket L 144mm W 25.5mm thickness 2.2mm for heating element suitable for GIORIK equiv. no. 2005173			

	GEV No.	418858	Ref. No.	6002100
description	heating element 7350W 230V heating circuits 3 ID ø 215mm ED ø 230mm L 267mm H 85mm L1 38mm W1 102mm H1 5mm H2 80mm flange length 142mm flange width 25mm hole distance 63mm cable length 1000mm convection heating element hole ø 6mm			
For models:	EF4PM, EF5GM			

	GEV No.	418086	Ref. No.	6002001
description	heating element 8400W 230V heating circuits 3 ID ø 218mm ED ø 235mm L 275mm H 112mm L1 40mm W1 105mm H1 32mm H2 80mm flange length 142mm flange width 25mm hole distance 64mm connection M4 tube ø 8.5mm convection heating element hole ø 6mm rectangular flange			
For models:	CE06MX, DE06EC, DE06ES, DE06MX, VE06EC, VE06MX			
accessories for	418086			
	GEV No.	550548	Ref. No.	2005173
	gasket L 144mm W 25.5mm thickness 2.2mm for heating element suitable for GIORIK equiv. no. 2005173			



Зип.Общепит

vsezip.ru

+7(812)987-08-81

accessories

flange gaskets



1

GEV No.	550548	Ref. No.	2005173
description	gasket L 144mm W 25.5mm thickness 2.2mm for heating element suitable for GIORIK equiv. no. 2005173		
For models:	CE06MX, CE102MX, CE10MX, CE20MX, DE06EC, DE06ES, DE06MX, DE102EC, DE102MX, DE10EC, DE10ES, DE10MX, EF10GM, EF4PM, EF5GM, EF8PM, VE06EC, VE06MX, VE102EC, VE102MX, VE10EC, VE10MX, VE20EC, VE20MX		



1

GEV No.	510368	Ref. No.	2005174
description	gasket L 70mm W 23.5mm hole ø 5mm hole distance 56mm FIBER thickness 2mm for heating element		
For models:	EF4, EF6PM, EF7GM, EN10VE-EC-ESN1033		

energy regulators

EGO

1-circuit



1

GEV No.	380015	Ref. No.	6031020 6031023 6031024
description	energy regulator 230V 13A single-circuit turn direction right shaft ø 6x4.6mm shaft L 23mm mounting thread M4 power release 6-100% no. 50.57021.010		
For models:	DE06ES, DE06MX, DE102MX, DE10ES, DE10MX, DG06ES, DG06MX, DG102MX, DG10ES, DG10MX, EF10GM, EF4PM, EF5GM, EF6PM, EF7GM, EF8PM, GF10GM, GF4PM, GF5GM, GF6PM, GF7GM, GF8PM, S505, S505R, S510, S510S, S511, S511S, SR512R, VE06MX, VE102MX, VE10MX, VE20MX, VG06MX, VG102MX, VG10MX, VG20MX		

control and safety thermostats

EGO

control thermostats



1

GEV No.	375007	Ref. No.	6010015
description	thermostat t.max. 110°C temperature range 30-110°C 1-pole 1NO 16A probe ø 6mm probe L 113mm capillary pipe 870mm capillary pipe isolatedmm gland nut M9x1 shaft L 25mm shaft position upper rotation 270°		
For models:	BME46, BME66, CP1BM, CPG1BM, SPE46		
accessories for	375007		
		GEV No.	110119
		Ref. No.	—
	knob thermostat t.max. 110°C ø 50mm shaft ø 6x4.6mm shaft flat upper black temperature range 30-110°C rotation 270°		
		GEV No.	110241
		Ref. No.	—
	knob thermostat t.max. 110°C ø 50mm shaft ø 6x4.6mm shaft flat upper black temperature range 30-110°C		

safety thermostats

55.10/19_ series



1

GEV No.	375968	Ref. No.	6010026
description	safety thermostat switch-off temp. 360°C 1-pole 1NC 16A probe ø 6mm probe L 77mm capillary pipe 870mm capillary pipe isolated 660mm gland nut M10x1 probe probe material SS M8x1		
For models:	CG102MX, CG10MX, DG06EC, DG06ES, DG06MX, DG102EC, DG102MX, DG10EC, DG10ES, DG10MX, EF4, GF10GM, GF4PM, GF5GM, GF6PM, GF7GM, GF8PM, VG06EC, VG06MX, VG102EC, VG102MX, VG10EC, VG10MX		

electric components



55.32_series

E-G-O



1

GEV No.	375277	Ref. No.	6010002
description	safety thermostat switch-off temp. 150°C 3-pole 3NC 20A probe ϕ 6mm probe L 79mm capillary pipe 900mm capillary pipe isolated 700mm gland nut probe		
For models:	22CP, 23CP, 2CP, 3CP, CP1, CP1BM, CPE66, EN10VE-EC-ESN1033, VE06EC, VE06MX, VE10EC, VE10MX, VG06EC, VG06MX, VG102EC, VG102MX, VG10EC, VG10MX, VG20EC, VG20MX		

E-G-O

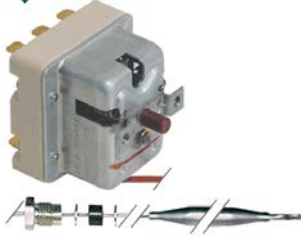

1

GEV No.	375628	Ref. No.	6010008
description	safety thermostat switch-off temp. 350°C 3-pole 20A probe ϕ 4mm probe L 120mm capillary pipe 900mm capillary pipe isolated 670mm gland nut M10x1 probe SS		
For models:	CE06MX, CE102MX, CE10MX, CE20MX, CG06MX, CG20MX, DE06EC, DE06ES, DE06MX, DE102EC, DE102MX, DE10EC, DE10ES, DE10MX, EF10GM, EF4PM, EF5GM, EF6PM, EF7GM, EF8PM, EN10VE-EC-ESN1033, VE06EC, VE06MX, VE102EC, VE102MX, VE10EC, VE10MX, VE20EC, VE20MX, VG20EC, VG20MX		

E-G-O

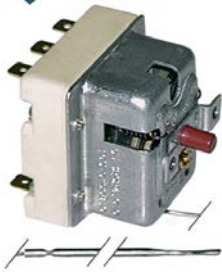

1

GEV No.	390142	Ref. No.	5910029
description	safety thermostat switch-off temp. 360°C 3-pole 20A probe ϕ 3.1mm probe L 188mm capillary pipe 1490mm capillary pipe isolated 800mm gland nut probe SS		

Зип Общежит

accessories

gland nut accessories
bolts with slot

+7(812)987-08-81

1

GEV No.	520244	Ref. No.	6030024
description	bolt with slot thread M10x1 Qty 10 pcs nickel-plated brass		
For models:	FTR10		

connecting bows



1

GEV No.	550060	Ref. No.	6030016
description	connecting bow long for thermostat Qty 1 pcs		
For models:	FRE46F, FRE46R, FRE66F, FRE66R, FT3N, FT5, FTE100, FTE107, FTE46, FTE46B, FTE46R, FTE47L, FTE66L, FTE66LB, FTE66LM, FTE66LMB, FTE66R, FTE66RM, FTR26F, FTR6F, SPE46		

switches and momentary switches

rocker/momentary rocker switches

30x22mm



1



GEV No.	346377	Ref. No.	6032030	
description	rocker switch mounting measurements 30x22mm black 2CO 230V 16A 0-I connection male faston 6.3mm ambient temperature max. 125/55°C protection IP40			
accessories for	346377			
	GEV No.	301036	Ref. No.	—
	protective cover internal size 30x22mm for rocker switch mounting measurementsmm			



push/momentary push switches

ø16mm



GEV No.	346345	Ref. No.	6032020
description	momentary push switch mounting ø 16mm black 1NO 250V 3A connection male faston 2.8mm ambient temperature max. 85°C protection IP40		
For models:	CE06MX, CE102MX, CE10MX, CE20MX, CG06MX, CG102MX, CG10MX, CG20MX, DE06MX, DE102MX, DE10MX, DG06MX, DG102MX, DG10MX, VE06MX, VE102MX, VE10MX, VE20MX, VG06MX, VG102MX, VG10MX, VG20MX		
accessories for	346345		
	GEV No.	346343	Ref. No. 6032021
	protective cover		
	GEV No.	346344	Ref. No. 6032022
	ring for protecting cover		



GEV No.	346346	Ref. No.	6032038
description	momentary push switch mounting ø 16mm red 1NO/indicator light 250V 3A connection male faston 2.8mm ambient temperature max. 125/55°C protection IP40		
For models:	CG20MX, DG06EC, DG06ES, DG06MX, DG102EC, DG102MX, DG10EC, DG10ES, DG10MX, GF10GM, GF4PM, GF5GM, GF6PM, GF7GM, GF8PM, VG06EC, VG06MX, VG102EC, VG102MX, VG10EC, VG10MX, VG20EC, VG20MX		

accessories

protective covers



GEV No.	346343	Ref. No.	6032021
description	protective cover		
For models:	CE06MX, CE102MX, CE10MX, CE20MX, CG06MX, CG102MX, CG10MX, CG20MX, DE06MX, DE102MX, DE10MX, DG06EC, DG06MX, DG102EC, DG102MX, DG10EC, DG10MX, VE06MX, VE102MX, VE10MX, VE20MX, VG06EC, VG06MX, VG102EC, VG102MX, VG10EC, VG10MX, VG20EC, VG20MX		
accessories for	346343		
	GEV No.	346344	Ref. No. 6032022
	ring for protecting cover		

Зип Общепит

vsezip.ru

+7(812)987-08-81

GEV No.	346344	Ref. No.	6032022
description	ring for protecting cover		
For models:	CE06MX, CE102MX, CE10MX, CE20MX, CG06MX, CG102MX, CG10MX, CG20MX, DE06MX, DE102MX, DE10MX, DG06EC, DG06MX, DG102EC, DG102MX, DG10EC, DG10MX, VE06MX, VE102MX, VE10MX, VE20MX, VG06EC, VG06MX, VG102EC, VG102MX, VG10EC, VG10MX, VG20EC, VG20MX		
accessories for	346344		
	GEV No.	346343	Ref. No. 6032021
	protective cover		

microswitches

lever actuated



GEV No.	345773	Ref. No.	6043085
description	microswitch with lever 250V 16A 1CO connection male faston 6.3mm L 60mm ambient temperature max. 125°C mounting distance 22mm actuating force: 65g lever length 51mm		
For models:	15FE, 15FEC, 20FE, 20FEC, 210FE, 210FEC, 215FE, 215FEC, 220FE, 220FEC, 920FE, 920FEC, 922FE, 922FEC, 940FE, 940FEC, F10CL, F10L, F15CL, F15L, F215CL, F215L, FP18NS, FP18S, FP27S, FRE46, FRE46R, FRE66, FRE66R, SH510P, SH560P		

pin-plunger actuated

M10



GEV No.	346347	Ref. No.	6043088
description	microswitch with plunger thread M10x0.75 thread L 14mm 250V 6A 2NO connection male faston 6.3mm stroke 4mm mounting distance 22mm ambient temperature max. 85°C actuating force: 100g		
For models:	CE06MX, CE102MX, CE10MX, CE20MX, CG06MX, CG102MX, CG10MX, CG20MX, DE06EC, DE06ES, DE06MX, DE102EC, DE102MX, DE10EC, DE10ES, DE10MX, DG06EC, DG06ES, DG06MX, DG102EC, DG102MX, DG10EC, DG10ES, DG10MX, VE06EC, VE06MX, VE102EC, VE102MX, VE10EC, VE10MX, VE20EC, VE20MX, VG06EC, VG06MX, VG102MX, VG10EC, VG10MX, VG20EC, VG20MX		



GEV No.	345032	Ref. No.	6043080
description	microswitch with plunger thread M10x1 thread L 12mm 250V 16A 1CO connection male faston 6.3mm stroke 7mm mounting distance 22mm L 28mm ambient temperature max. 125°C type SP9603 actuating force: 180g		

electric components



cam switches

on/off

E-G-O

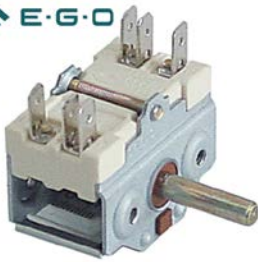

1

GEV No.	300129	Ref. No.	6030007
description	cam switch 2 operating positions 2NO sequence 0-1 16A shaft \varnothing 6x4.6mm shaft L 23mm connection male faston 6.3mm ceramic		
For models:	13FGC, 17FGC, 207FGC, 213FGC, 217FGC, 917FGC, 927FGC, 934FGC, BM711, BM721, BM911, BM921, BME46, BME66, CE06MX, CE102MX, CE10MX, CE20MX, CG06MX, CG102MX, CG10MX, CG20MX, EF10GM, EF4PM, EF5GM, EF6PM, EF7GM, EF8PM, EN10VE-EC-ESN1033, FG07CL, FG213CL, GF10GM, GF4PM, GF5GM, GF6PM, GF7GM, GF8PM		



1

GEV No.	300139	Ref. No.	6030012
description	cam switch ON-OFF connection male faston		
For models:	210FEC, 922FEC, EF4, F10CL, F15CL, F215CL, FP18NS, FP18S, FP27S, FTR10, SH505R, SH510P, SH510R, SH520G, SH520GM, SH560P		

7-position

E-G-O



1

GEV No.	300106	Ref. No.	6030001
description	cam switch 7 operating positions 1NO/2CO sequence 0-1-2-3-4-5-6 32A shaft \varnothing 6x4.6mm shaft L 23mm connection screw 7-position shaft flat upper		

Зип Общежит

4 operating positions



1

GEV No.	300010	Ref. No.	6030018 6030018OBS
description	cam switch 4 operating positions 2NO/2CO sequence 0-1-2-3 16A shaft \varnothing 6x4.6mm shaft L 23mm connection male faston 6.3mm ceramic		

operation switches

E-G-O



1

GEV No.	300002	Ref. No.	6030019
description	cam switch 2 operating positions 4NO 16A sequence 0-1 shaft \varnothing 6x4.6mm shaft L 23mm connection male faston 6.3mm ceramic		

E-G-O



1

GEV No.	300200	Ref. No.	6030015
description	operation switch 2 operating positions 2NO 16A sequence 0-1 shaft \varnothing 6x4.6mm shaft L 23mm connection male faston 6.3mm operation switch ceramic		
For models:	13FG, 17FG, 207FG, 213FG, 217FG, 917FG, 927FG, 934FG, CP1BM, CPG1BM, FRE46F, FRE66F, FT3N, FT5, FTE100, FTE107, FTE46, FTE46B, FTE46R, FTE47L, FTE66LM, FTE66LMB, FTE66RM, FTR26F, FTR6F, SPE46		

rotary switches

BREMAS

A1600 series





1

GEV No.	346342	Ref. No.	6030031
description	rotary switch 7 1-2-3-4-5-6-7 sets of contacts 9 type CS0169137 400V 16A shaft \varnothing 4x5mm shaft L 20mm shaft square connection screw		
For models:	VE06MX, VE102MX, VE10MX, VE20MX, VG06MX, VG102MX, VG10MX, VG20MX		





Зип-Общепит
vsezip.ru
7(812)987-08-81

 <p>1</p>			
GEV No.	346341	Ref. No.	6030030
description	rotary switch 8 1-2-3-4-5-6-7-8 sets of contacts 10 type CS0169134 400V 16A shaft ø 4x5mm shaft L 20mm shaft square connection screw		
For models:	DE06EC, DE06ES, DE06MX, DE102EC, DE10EC, DE10ES, DE10MX, DG06EC, DG06ES, DG06MX, DG102EC, DG102MX, DG10EC, DG10ES, DG10MX, VE06EC, VE102EC, VE10EC, VE20EC, VG06EC, VG102EC, VG10EC, VG20EC		

 <p>1</p>			
GEV No.	359430	Ref. No.	6061067
description	indicator lamp 230V clear connection cable 400mm		
For models:	EF4, FP18NS, FP18S, FP27S, FT3N, FT5, FTR10, FTR26F, FTR26T, FTR6F, FTR6T, S505, S505R, S510, S510S, S511, S511S		
accessories for	359430		
	 <p>GEV No. 359260 Ref. No. —</p>	indicator light housings mounting measurements ø12mm yellow round Qty 1 pcs	

encoders and potentiometers

 <p>1</p>			
GEV No.	401169	Ref. No.	6010102
description	encoder cable length 125mm		
For models:	DE06EC, DE102EC, DE10EC, DG06EC, DG102EC, DG10EC, SH505R, SH510P, SH510R, SH520G, SH520GM, SH560P, VE06EC, VE102EC, VE10EC, VE20EC, VG06EC, VG102EC, VG10EC, VG20EC		

 <p>1</p>			
GEV No.	359431	Ref. No.	6061068
description	indicator lamp 230V green connection cable 400mm cable material silicone		
For models:	EF4, FP18NS, FP18S, FP27S, FT3N, FT5, FTR10, FTR26F, FTR26T, FTR6F, FTR6T, SR512, SR512R		

 <p>1</p>			
GEV No.	300187	Ref. No.	6010097
description	potentiometer 4.7KOhm rotation 310° shaft ø 0.6x4.5mm shaft L 20mm cable length 650mm		
For models:	CE06MX, CE102MX, CE10MX, CE20MX, CG06MX, CG102MX, CG10MX, CG20MX, DE06ES, DE06MX, DE102MX, DE10ES, DE10MX, DG06ES, DG06MX, DG102MX, DG10ES, DG10MX, EF10GM, EF4PM, EF5GM, EF6PM, EF7GM, EF8PM, GF10GM, GF4PM, GF5GM, GF6PM, GF7GM, GF8PM, VE06MX, VE102MX, VE10MX, VE20MX, VG06MX, VG102MX, VG10MX, VG20MX		

indicator lights (complete) ø12mm with screw socket			
 <p>1</p>			
GEV No.	359048	Ref. No.	6061051
description	indicator light ø 12mm 230V yellow connection male faston 6.3mm		

lamps

indicator lights

indicator lights 2-piece (lens and indicator lamp)

indicator light lenses

ø13mm (type SFK-3)

 <p>1</p>			
GEV No.	359225	Ref. No.	6061069
description	indicator light housings mounting measurements ø13mm clear Qty 1 pcs		
For models:	EF4, FP18NS, FP18S, FP27S, FT3N, FT5, FTR10, FTR26F, FTR26T, FTR6F, FTR6T, S505, S505R, S510, S510S, S511, S511S		

 <p>1</p>			
GEV No.	359291	Ref. No.	6061050
description	indicator light ø 12mm 400V green connection male faston 6.3mm		

screw-on/push-on fit

light bulbs

for ovens

 <p>1</p>			
GEV No.	359610	Ref. No.	6061052
description	light bulb t.max. 300°C socket E14 15W 230V ø 22mm L 47mm lens L 20mm for oven lamp type Philips		



PHILIPS



1

GEV No.	359612	Ref. No.	6061053
description	light bulb t.max. 300°C socket E14 25W 230V ø 25mm L 56mm lens L 30mm for oven lamp type Philips		
For models:	EN10VE-EC-ESN1033		

halogen lamp

for socket G4 / G6.35 / G9



1

GEV No.	359599	Ref. No.	6061054
description	halogen lamp socket G4 12V 20W temp.-resist. 500°C		
For models:	CE06MX, CE102MX, CE10MX, CE20MX, CG06MX, CG102MX, CG10MX, CG20MX, DE06EC, DE06ES, DE06MX, DE102EC, DE102MX, DE10EC, DE10ES, DE10MX, DG06EC, DG06ES, DG06MX, DG102EC, DG102MX, DG10EC, DG10ES, DG10MX, VE06EC, VE06MX, VE102EC, VE102MX, VE10EC, VE10MX, VE20EC, VE20MX, VG06EC, VG06MX, VG102EC, VG102MX, VG10EC, VG10MX, VG20EC, VG20MX		



oven lamps

universal oven lamps

mounting diameter 35.5mm



1

GEV No.	359718	Ref. No.	6063072	
description	oven lamp mounting ø 35.5mm 230V 15W socket E14 temp.-resist. 300°C connection male faston 6.3mm hard glas			
spare parts for	359718			
	GEV No.	359701	Ref. No.	—
	lamp socket socket E14 220-230V mounting ø 35.5mm connection male faston 6.3mm 15W			
	GEV No.	359740	Ref. No.	—
	light bulb t.max. 300°C socket E14 15W 230V ø 22mm L 48mm lens L 20mm for oven lamp IMPORT			

Зип Общепит



vsezip.ru

+7(812)987-08-81

mounting diameter 47.8mm



1

GEV No.	359499	Ref. No.	6060055	
description	lamp socket socket E14 mounting ø 47.8mm connection male faston 6.3mm			
For models:	EF10GM, EF4PM, EF5GM, EF6PM, EF7GM, EF8PM, GF10GM, GF4PM, GF5GM, GF6PM, GF7GM, GF8PM			
accessories for	359499			
	GEV No.	359612	Ref. No.	6061053
	light bulb t.max. 300°C socket E14 25W 230V ø 25mm L 56mm lens L 30mm for oven lamp type Philips			
	GEV No.	359725	Ref. No.	—
	oven lamp glass thread ø 44mm H 43mm ø 54mm hard glas temp.-resist. 350°C			

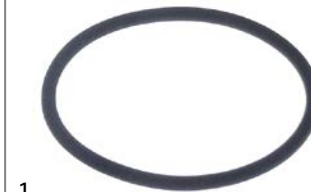

1

GEV No.	525313	Ref. No.	6090140
description	O-ring Viton ID ø 60.33mm thickness 3.53mm Qty 1 pcs		
For models:	EF10GM, EF4PM, EF5GM, EF6PM, EF7GM, EF8PM, GF10GM, GF4PM, GF5GM, GF6PM, GF7GM, GF8PM		



1

GEV No.	532649	Ref. No.	6090141
description	O-ring Viton ID ø 63.17mm thickness 2.62mm Qty 1 pcs		
For models:	EF10GM, EF4PM, EF5GM, EF6PM, EF7GM, EF8PM, GF10GM, GF4PM, GF5GM, GF6PM, GF7GM, GF8PM		

Зип Общепит

vsezip.ru

+7(812)987-08-81

30x70mm

1



GEV No.	359338	Ref. No.	6063077
description	lamp glass		
For models:	CE06MX, CE102MX, CE10MX, CE20MX, CG06MX, CG102MX, CG10MX, CG20MX, DE06EC, DE06ES, DE06MX, DE102EC, DE102MX, DE10EC, DE10ES, DE10MX, DG06EC, DG06ES, DG06MX, DG102EC, DG102MX, DG10EC, DG10ES, DG10MX, VE06EC, VE06MX, VE102EC, VE102MX, VE10EC, VE10MX, VE20EC, VE20MX, VG06EC, VG06MX, VG102EC, VG102MX, VG10EC, VG10MX, VG20EC, VG20MX		

2



GEV No.	359337	Ref. No.	6063075
description	oven lamp socket G4 cable length 800mm connection Faston 6.3mm L 70mm W 29mm		
For models:	CE06MX, CE102MX, CE10MX, CE20MX, CG06MX, CG102MX, CG10MX, CG20MX, DE06EC, DE06ES, DE06MX, DE102EC, DE102MX, DE10EC, DE10ES, DE10MX, DG06EC, DG06ES, DG06MX, DG102EC, DG102MX, DG10EC, DG10ES, DG10MX, VE06EC, VE06MX, VE102EC, VE102MX, VE10EC, VE10MX, VE20EC, VE20MX, VG06EC, VG06MX, VG102EC, VG102MX, VG10EC, VG10MX, VG20EC, VG20MX		
accessories for	359337		
	 GEV No.	359599	Ref. No. 6061054
	halogen lamp socket G4 12V 20W temp.-resist. 500°C		

55x70mm

1



GEV No.	359368	Ref. No.	6063074
description	lamp glass		

55x100mm





1



GEV No.	359714	Ref. No.	6063070
description	gasket silicone L 140mm W 75mm for bulb socket		

1



GEV No.	101372	Ref. No.	6063069
description	oven lamp complete L 100mm W 55mm 230V 25W socket E14 rectangular temp.-resist. 300°C connection male faston 6.3mm		
spare parts for	101372		
 GEV No.	359612	Ref. No.	6061053
	light bulb t.max. 300°C socket E14 25W 230V ø 25mm L 56mm lens L 30mm for oven lamp type Philips		
 GEV No.	359698	Ref. No.	—
	lamp socket L 100mm W 55mm socket E14 connection male faston 6.3mm		
 GEV No.	359714	Ref. No.	6063070
	gasket silicone L 140mm W 75mm for bulb socket		
 GEV No.	359715	Ref. No.	—
	lamp glass L 110mm W 65mm thickness 5mm		
 GEV No.	359716	Ref. No.	—
	frame for bulb socket		

lamps

light bulbs

1



GEV No.	359610	Ref. No.	6061052
description	light bulb t.max. 300°C socket E14 15W 230V ø 22mm L 47mm lens L 20mm for oven lamp type Philips		

1



GEV No.	359612	Ref. No.	6061053
description	light bulb t.max. 300°C socket E14 25W 230V ø 25mm L 56mm lens L 30mm for oven lamp type Philips		
For models:	EN10VE-EC-ESN1033		



Зип-Общепит

mechanical timers

halogen lamps

for socket G4 / G6.35 / G9



GEV No.	359599	Ref. No.	6061054
description	halogen lamp socket G4 12V 20W temp.-resist. 500°C		
For models:	CE06MX, CE102MX, CE10MX, CE20MX, CG06MX, CG102MX, CG10MX, CG20MX, DE06EC, DE06ES, DE06MX, DE102EC, DE102MX, DE10EC, DE10ES, DE10MX, DG06EC, DG06ES, DG06MX, DG102EC, DG102MX, DG10EC, DG10ES, DG10MX, VE06EC, VE06MX, VE102EC, VE102MX, VE10EC, VE10MX, VE20EC, VE20MX, VG06EC, VG06MX, VG102EC, VG102MX, VG10EC, VG10MX, VG20EC, VG20MX		

timers

electric timers



GEV No.	350135	Ref. No.	6032042 6032059
description	timer M565 operation time 120min time spreadmin 1CO/2NO at 250V 16A permanent position yes time range 0-120min impulse electric shaft ø 6x4.6mm shaft L 21mm mounting distance 28mm connection male faston 6.3mm screw mounting 250V voltage AC 50Hz		

with time spread





GEV No.	350074	Ref. No.	6032047
description	timer M565 operation time 120min time spread 30min 1CO/2NO/1NC at 250V 16A permanent position yes impulse electric shaft ø 6x4.6mm shaft L 22mm mounting distance 28mm connection lateral Invensys 4-pole shaft position lower°		
For models:	CE06MX, CE102MX, CE10MX, CE20MX, CG06MX, CG102MX, CG10MX, CG20MX, DE06ES, DE06MX, DE102MX, DE10ES, DE10MX, DG06ES, DG06MX, DG102MX, DG10ES, DG10MX, EF10GM, EF4, EF4PM, EF5GM, EF6PM, EF7GM, EF8PM, GF10GM, GF4PM, GF5GM, GF6PM, GF7GM, GF8PM, VE06MX, VE102MX, VE10MX, VE20MX, VG06MX, VG102MX, VG10MX, VG20MX		

vsezip.ru

+7(812)987-08-81



GEV No.	350003	Ref. No.	6032040	
description	timer M2 with bell 2-pole operation time 120min impulse mechanical 2NO at 250V 16A permanent position no shaft ø 6x4.6mm shaft 6x4.6mm shaft L 23mm mounting distance 28mm connection lateral			
accessories for	350003			
	GEV No.	110366	Ref. No.	—
	knob switch zero mark t.max.°C°C ø 44mm shaft ø 6x4.6mm shaft flat upper black			
	GEV No.	111199	Ref. No.	—
	dial plate graduation 120min permanent position no rotation 0-330° ø 60mm timers knob ø 45mm			

alarm devices

buzzer boards



GEV No.	401062	Ref. No.	6010090
description	buzzer board 230VAC L 48mm W 45mm connection Faston 6.3mm		
For models:	CE06MX, CE102MX, CE10MX, CE20MX, CG06MX, CG102MX, CG10MX, CG20MX, DE06MX, DE102MX, DE10MX, DG06MX, DG102MX, DG10MX, EF10GM, EF4PM, EF5GM, EF6PM, EF7GM, EF8PM, GF10GM, GF4PM, GF5GM, GF6PM, GF7GM, GF8PM		

contactors

ABB

power contactors



GEV No.	380100	Ref. No.	6046045
description	power contactor resistive load 20A 230VAC (AC3/400V) 12A/5.5kW main contacts 3NO auxiliary contacts 1NO connection screw connection type B6-30-10 / B7-30-10		

auxiliary contacts



1	GEV No.	381028	Ref. No.	6046145
description auxiliary contact contacts 1NO/1NC AC1 6A AC15 3A connection screw connection for contactors B6/B7/VB7				

GENERAL ELECTRIC (AEG)

power contactors



1	GEV No.	380244	Ref. No.	6046043
description power contactor resistive load 25A 230VAC (AC3/400V) 9A/4kW main contacts 3NO auxiliary contacts 1NO connection screw connection type AEG LS4K 10A type GE CL00A 310				
For models: F10CL, F10L, F15CL, F15L, F215CL, F215L, FP18NS, FP18S, FP27S, FRE46, FRE66				

ISKRA (FANAL)

power contactors



1	GEV No.	380204	Ref. No.	6046033 6046038
description power contactor resistive load 25A 230VAC (AC3/400V) 9A/4kW main contacts 3NO auxiliary contacts 1NO connection screw connection type Fanal DSL9 10 type ISKRA KNL9 10				
For models: 15FE, 15FEC, 20FEC, 210FE, 210FEC, 215FE, 215FEC, 220FEC, 920FEC, 922FE, 922FEC, 940FEC, CE06MX, CE102MX, CE10MX, CE20MX, CG06MX, CG102MX, CG10MX, CG20MX, DE06EC, DE06ES, DE06MX, DE102EC, DE102MX, DE10EC, DE10ES, DE10MX, DG06ES, DG06MX, DG102MX, DG10ES, DG10MX, EF10GM, EF4, EF4PM, EF5GM, EF6PM, EF7GM, EF8PM, EN10VE-EC-ESN1033, GF10GM, GF4PM, GF5GM, GF6PM, GF7GM, GF8PM, VE06EC, VE06MX, VE102EC...(Other models you can see in the webshop)				

Зип Общепит

vsezip.ru

+7(812)987-08-81



1	GEV No.	380424	Ref. No.	6046041					
description power contactor resistive load 35A 230VAC (AC3/400V) 32A/15kW main contacts 3NO connection screw connection type Fanal DSL30 type ISKRA KNL30									
accessories for 380424									
<table border="1"> <tr> <td></td> <td>GEV No.</td> <td>381378</td> <td>Ref. No.</td> <td>—</td> </tr> </table>						GEV No.	381378	Ref. No.	—
	GEV No.	381378	Ref. No.	—					
overload switch connection screw setting range 24,5-30A for contactors KNL30 type BR30 24.5-30A									

relays

power relays

with DIN rail mounting

lateral



1	GEV No.	380379	Ref. No.	6041013
description power relays SCHRACK 230VAC 25A 2CO connection male faston 6.3mm DIN rail manuf. no. RM809730				
For models: SH505R, SH510R				

with bracket mounting



1	GEV No.	380702	Ref. No.	6041008
description power relays FINDER 230VAC 16A 3NO connection male faston 6.3mm flange dimensions 36x38x68mm manuf. no. 62.83.8.230.0300 230V				



plug-in/print relays

Зип Общепит

level relays

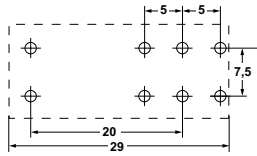

1

GEV No.	380333	Ref. No.	6041009
description	print relay 230VAC 2CO at 250V 8A connection pins raster size 5mm FINDER manuf. no. 40.52.8.230.0000 95.65/95.75		
accessories for	380333		
	GEV No.	Ref. No.	—
	380340		
	relay socket dimensions 62x36x15mm 250V voltage AC 10A Italiana Relè manuf. no. ZMEM/5		
	GEV No.	Ref. No.	—
	380505		
	relay socket 2CO 40.52 dimensions 81.9x15.5x75mm 250V voltage AC 10A FINDER manuf. no. 95.95.3		
	GEV No.	Ref. No.	6040015
	381181		
	relay socket 2-pole 40.51/40.52/40.61 connection screw clamp dimensions 15.8x78.6mm 250V voltage AC 10A FINDER manuf. no. 95.75		

relay sockets



1

GEV No.	381181	Ref. No.	6040015
description	relay socket 2-pole 40.51/40.52/40.61 connection screw clamp dimensions 15.8x78.6mm 250V voltage AC 10A FINDER manuf. no. 95.75		
accessories for	381181		
	GEV No.	Ref. No.	—
	381455		
	support bracket		

GICAR
vsezip.ru

+7(812)987-08-81



1

GEV No.	401173	Ref. No.	6041043
description	level relay 230V connection F6.3 type RL30/3ES/F		
For models:	EN10VE-EC-ESN1033, VE06EC, VE06MX, VE102EC, VE102MX, VE10EC, VE10MX, VE20EC, VE20MX, VG06EC, VG06MX, VG102EC, VG102MX, VG10EC, VG10MX, VG20EC, VG20MX		

time relays

time relays



1

GEV No.	381119	Ref. No.	6042049
description	time relay LOVATO TM D time range 0.06-180s		
For models:	VE06EC, VE06MX, VE102EC, VE102MX, VE10EC, VE10MX, VE20EC, VE20MX, VG06EC, VG06MX, VG102EC, VG102MX, VG10EC, VG10MX, VG20EC, VG20MX		



1

GEV No.	380607	Ref. No.	6042054
description	time relay LOVATO TM M1 time range 0s-10 days 12-24V AC/DC 8A 1CO connection grip connection		
For models:	VE06MX, VE102MX, VE10MX, VE20MX, VG06MX, VG102MX, VG10MX, VG20MX		



Зип Обществит
electronic controllers

vsezip.ru

+7(812)987-08-81



1

GEV No.	380606	Ref. No.	6042056
description	time relay LOVATO TM PL time range 2x 0.1s-100 days 12-240V AC/DC 8A 1CO connection grip connection		
For models:	DE06ES, DE06MX, DE102MX, DE10ES, DE10MX, DG06ES, DG06MX, DG102MX, DG10ES, DG10MX		

transformers

encapsulated transformers

PMA



1

GEV No.	379054	Ref. No.	6010086
description	transformer primary 230VAC secondary 12VAC 3VA secondary 0.25A H 40mm L 45mm W 50mm connection screw 50/60Hz type 153/M		
For models:	SH505R, SH510R, SH520G, SH520GM		



1

GEV No.	401174	Ref. No.	6010079
description	transformer primary 230VAC secondary 12VAC 6VA secondary 0.5A connection screw 50Hz		
For models:	DE06EC, DE102EC, DE10EC, DG06EC, DG102EC, DG10EC, EN10VE-EC-ESN1033, SH510P, SH560P, VE06EC, VE102EC, VE10EC, VE20EC, VG06EC, VG102EC, VG10EC, VG20EC		

for lighting



1

GEV No.	401175	Ref. No.	6041065
description	transformer primary 230V secondary 11.5V 90VA		
For models:	CE06MX, CE102MX, CE10MX, CE20MX, CG06MX, CG102MX, CG10MX, CG20MX, DE06EC, DE06ES, DE06MX, DE102EC, DE102MX, DE10EC, DE10ES, DE10MX, DG06EC, DG06ES, DG06MX, DG102EC, DG102MX, DG10EC, DG10ES, DG10MX, VE06EC, VE06MX, VE102EC, VE102MX, VE10EC, VE10MX, VE20EC, VE20MX, VG06EC, VG06MX, VG102EC, VG102MX, VG10EC, VG10MX, VG20EC, VG20MX		

EVCO - EVERY CONTROL

universal controllers

built-in version

66,5 x 66,5mm



1

GEV No.	378169	Ref. No.	6011125 6011130
description	electronic controller EVERY CONTROL EV7401 mounting measurements 66.5x66.5mm built-in depth 90mm 24/230V voltage AC NTC/PTC/Pt100/TC(J,K)/mA relay outputs 1 CO-8A(3) NTC/PTC/Pt100/TC(J,K)/mA yes protection IP54 dependend on probe°C display 4 digits		
accessories for	378169		
	GEV No.	Ref. No.	—
	temperature probe PTC 1kOhm cable PVC probe -50 up to +150°C cable -10 up to 100°C probe ø6x30mm cable length 3m without screw connection 2-wire		
	GEV No.	Ref. No.	—
	temperature probe thermocouple J (Fe-CuNi) cable Vetrotex probe -50 up to +750°C cable -50 up to +350°C probe ø6x50mm cable length 3m without screw connection 2-wire		
	GEV No.	Ref. No.	—
	temperature probe PTC 1kOhm cable silicone probe -50 up to +150°C cable -50 up to +180°C probe ø6x40mm cable length 3m without screw connection 2-wire		
	GEV No.	Ref. No.	—
	temperature probe Pt100 cable Vetrotex probe -200 up to +600°C cable -50 up to +350°C probe ø6x85mm cable length 3m without screw connection 3-wire resistance at 0°C 100Ohm		
	GEV No.	Ref. No.	—
	temperature probe NTC 10kOhm cable thermoplastic probe -40 up to +110°C cable -40 up to +110°C probe ø6x14mm cable length 3m without screw connection 2-wire		



SHANGFANG

Зип.Общепит electronics

frequency converters

vsezip.ru
+7(812)987-08-81

accessories



1			
GEV No.	379054	Ref. No.	6010086
description	transformer primary 230VAC secondary 12VAC 3VA secondary 0.25A H 40mm L 45mm W 50mm connection screw 50/60Hz type 153/M		
For models:	SH505R, SH510R, SH520G, SH520GM		

1

GEV No.	403841	Ref. No.	6010130 6010131
description	frequency converter with heat sink for combi-steamer L 135mm W 135mm 800W ECS P0010205-0		

probes

universal probes

temperature probes



1			
GEV No.	379860	Ref. No.	6000100
description	temperature probe NTC 10kOhm cable PVC probe -20 up to +80°C cable -10 up to 100°C probe ø6x40mm cable length 1.5m without screw connection 2-wire		



1			
GEV No.	379222 ¹	Ref. No.	6000083
description	temperature probe Pt100 cable Vetrotex probe -200 up to +600°C cable -50 up to +350°C probe ø4x110mm cable length 1.4m 3-wire		
For models:	CE06MX, CE102MX, CE10MX, CE20MX, CG06MX, CG102MX, CG10MX, CG20MX, DE06ES, DE06MX, DE102MX, DE10ES, DE10MX, DG06ES, DG06MX, DG102MX, DG10ES, DG10MX, VE06MX, VE102EC, VE102MX, VE10MX, VE20MX, VG06MX, VG102MX, VG10MX, VG20MX		

¹3-wire

1			
GEV No.	379050 ¹	Ref. No.	6000085
description	temperature probe Pt100 cable Vetrotex probe -200 up to +600°C cable -50 up to +350°C probe ø6x100mm cable length 2.7m without screw connection 3-wire		
For models:	EF10GM, EF4PM, EF5GM, EF6PM, EF7GM, EF8PM, EN10VE-EC-ESN1033, GF10GM, GF4PM, GF5GM, GF6PM, GF7GM, GF8PM		

¹3-wire

PCBs

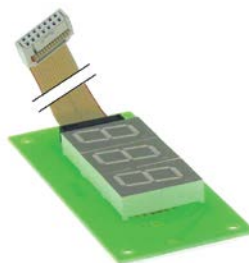

1			
GEV No.	401166	Ref. No.	6010095
description	display		
For models:	CE06MX, CE102MX, CE20MX, CG06MX, CG102MX, CG10MX, CG20MX, DE06ES, DE06MX, DE102MX, DE10ES, DE10MX, DG06ES, DG06MX, DG102MX, DG10ES, DG10MX, EF10GM, EF4PM, EF5GM, EF6PM, EF7GM, EF8PM, GF10GM, GF4PM, GF5GM, GF6PM, GF7GM, GF8PM, VE06MX, VE102MX, VE10MX, VE20MX, VG06MX, VG102MX, VG10MX, VG20MX		

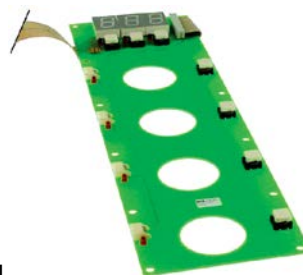

1			
GEV No.	401168	Ref. No.	6010100
description	PCB		
For models:	DE06EC, DE102EC, DE10EC, DG06EC, DG102EC, DG10EC, VE06EC, VE102EC, VE10EC, VE20EC, VG06EC, VG102EC, VG10EC, VG20EC		



Зип Обществит

solenoid valves

vsezip.ru

+7(812)987-08-81



1

GEV No.	401170	Ref. No.	6010101
description	PCB		
For models:	DE06EC, DE102EC, DE10EC, DG06EC, DG102EC, DG10EC, VE06EC, VE102EC, VE10EC, VE20EC, VG06EC, VG102EC, VG10EC		



1

GEV No.	401172	Ref. No.	6010093
description	PCB combi-steamer VE 06/10		
For models:	VE06EC, VE06MX, VE102EC, VE102MX, VE10EC, VE10MX, VE20EC, VE20MX, VG06EC, VG06MX, VG102EC, VG102MX, VG10EC, VG10MX, VG20EC, VG20MX		



1

GEV No.	401167	Ref. No.	6010096
description	PCB combi-steamer VE 06/10 230V 50/60Hz		
For models:	CE06MX, CE102MX, CE10MX, CE20MX, CG06MX, CG102MX, CG10MX, CG20MX, DE06ES, DE06MX, DE102MX, DE10ES, DE10MX, DG06ES, DG06MX, DG102MX, DG10ES, DG10MX, EF10GM, EF4PM, EF5GM, EF6PM, EF7GM, EF8PM, GF10GM, GF4PM, GF5GM, GF6PM, GF7GM, GF8PM, VE06MX, VE102MX, VE10MX, VE20MX, VG06MX, VG102MX, VG10MX, VG20EC, VG20MX		
accessories for	401167		
	GEV No.	401062	Ref. No. 6010090
	buzzer board 230VAC L 48mm W 45mm connection Faston 6.3mm		

solenoid valves (water)

RPE



1

GEV No.	374021	Ref. No.	6042071
description	solenoid valve double straight 230VAC inlet 3/4" outlet 10mm DN10 RPE		
For models:	CE20MX, CG20MX, VE06EC, VE06MX, VE102EC, VE102MX, VE10EC, VE10MX, VE20EC, VE20MX, VG06EC, VG06MX, VG102EC, VG102MX, VG10EC, VG10MX, VG20EC, VG20MX		



1

GEV No.	374017	Ref. No.	6042070
description	solenoid valve single straight 230VAC inlet 3/4" outlet 10mm input 6l/min DN10 RPE polyamide flow regulating valve inlet white membranes NBR pressure range 0.2-10bar		
For models:	CE06MX, CE102MX, CE10MX, CG06MX, CG102MX, CG10MX, DE06EC, DE06ES, DE06MX, DE102EC, DE102MX, DE10EC, DE10ES, DE10MX, DG06EC, DG06ES, DG06MX, DG102EC, DG102MX, DG10EC, DG10ES, DG10MX, EF10GM, EF4, EF4PM, EF5GM, EF6PM, EF7GM, EF8PM, GF10GM, GF4PM, GF5GM, GF6PM, GF7GM, GF8PM		



1

GEV No.	374025	Ref. No.	6042080
description	solenoid valve triple straight 230VAC inlet 3/4" outlet 10mm DN10 RPE		

reducers

outlet side



1

GEV No.	371269	Ref. No.	6042091
description	reducer flow rate 0.07-0.14l/min brown		



1

GEV No.	371265	Ref. No.	6042097
description	reducer flow rate 3l/min black		
For models:	VE06EC, VE06MX, VE102EC, VE102MX, VE10EC, VE10MX, VE20EC, VE20MX, VG06EC, VG06MX, VG102EC, VG102MX, VG10EC, VG10MX, VG20EC, VG20MX		

electric components

various



GEV No.	371264	Ref. No.	6042095
description	reducer flow rate 0.25l/min		
For models:	CE06MX, CE102MX, CE10MX, CE20MX, CG06MX, CG102MX, CG10MX, CG20MX, EF4, VE06EC, VE06MX, VE102EC, VE102MX, VE10EC, VE10MX, VE20EC, VE20MX, VG06EC, VG06MX, VG102EC, VG102MX, VG10EC, VG10MX, VG20EC, VG20MX		

metal

CEME

solenoid valves



GEV No.	370352	Ref. No.	6042075
description	solenoid valve 2-ways 230VAC inlet 1/2" IT outlet 1/2" IT L 55mm p max 0.5bar brass		
For models:	VE06EC, VE06MX, VE102EC, VE102MX, VE10EC, VE10MX, VE20EC, VE20MX, VG06EC, VG06MX, VG102EC, VG102MX, VG10EC, VG10MX, VG20EC, VG20MX		

ball valves electric



GEV No.	401139	Ref. No.	6042073
description	ball valve inlet 3/4" IT outlet 3/4" IT with plug 230V L 65mm 50/60Hz closed off-current mode of operation electric connection cable 200mm		

Зип.Общепит pressure switches

for gas equipment



GEV No.	541073	Ref. No.	7050012
description	pressure control ø 45mm pressure range adjustable 5-20mbar pressure connection vertical gas technology connection 1/4" pressure connection ø 1/4"mm		

for combi-steamers



GEV No.	541806	Ref. No.	7050008	
description	pressure control ø 38mm pressure range 0.2-3.0bar connection 1/8" 250V 10A GP600 pressure connection 1/8"			
accessories for	541806			
	GEV No.	541814	Ref. No.	—
	protection cap for pressure switch EPDM XP600			

electrodes



GEV No.	401161	Ref. No.	6000089
description	level electrode 1/4" total length 210mm probe L 184mm insulated probe length 26mm connection male faston 6.3mm stainless steel ø 2.5mm		

fans

axial fans

ebm-papst



1

GEV No.	601030 ¹	Ref. No.	6033175
description	axial fan L 119mm W 119mm H 38mm 230VAC 50Hz 18W bearing ball bearing manif. no. 4656Z metal connection male faston 2.8mm ebm-papst fan wheel ø 110mm temp.-resist. 75°C		
accessories for	601030		
	GEV No.	550898	Ref. No. —
	connecting cable cable length 2000mm connection F 2.8 connection distance 7.9mm for axial flow fan		
	GEV No.	692497	Ref. No. —
	guard ø 105mm mounting distance 150mm for axial fan ebm-papst-mm		

¹with ball bearings



1

GEV No.	601633 ¹	Ref. No.	6033172
description	axial fan L 92mm W 92mm H 38mm 230VAC 50Hz 12W bearing ball bearing manif. no. 3656 connection cable 310mm ebm-papst		
accessories for	601633		
	GEV No.	691103	Ref. No. —
	guard ø 90mm mounting distance 83mm for axial fan 92mm		

¹with ball bearings

Зип Общежит

hot air motors

vsezip.ru

+7(812)987-08-81



1

GEV No.	602014	Ref. No.	2017945 6032115 6033153
description	fan motor 208-240V 1 phase 50/60Hz 0.19-0.26/0.34-0.35kW 2800/3450rpm speeds 2 L1 98mm L2 33mm D1 ø 8mm M5 1-1.2/1.7-1.5A type MFA80		



1

GEV No.	500641	Ref. No.	6033155
description	fan motor 220/380V 3 phase 50Hz 0.75kW 1420rpm speeds 1 L1 166mm L2 47mm L3 65mm D1 ø 24mm D2 ø 20mm M6R IT 1.4/2.4A Cos(φ) 0.83 at 50Hz 220/380V at 60Hz 240/415V type ST80/4 no. 643515 mounting distance 150mm		



1



GEV No.	500640	Ref. No.	6032122
description	fan motor 220-240V 1 phase 50Hz 0.05/0.25HP 1400/2700rpm speeds 2 L1 145mm L2 65mm L3 35mm D1 ø 15mm D2 ø 12mm M10L ET 1.1/0.55A suitable capacitor 12.5µF/450V at 50Hz 1400/2700rpm type 2758D2253 no. 6032122		
For models:	CE06MX, CG06MX, DE06EC, DE06ES, DE06MX, DG06EC, DG06ES, DG06MX, VE06EC, VE06MX, VG06EC, VG06MX		
spare parts for	500640		
	GEV No.	560280	Ref. No. —
	nut thread M10L H 8mm WS 17 SS DIN/ISO DIN 934 / ISO 4032/8673 Qty 1 pcs		

Зип Общепит

vsezip.ru

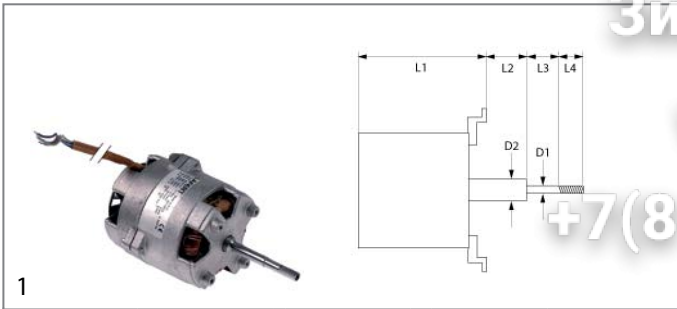
+7(812)987-08-81



GEV No.	601354	Ref. No.	6032128
description	fan motor 220-240V 1 phase 50Hz 0.11kW 2760rpm speeds 1 L1 130mm L2 32mm L3 30mm L4 18mm D1 \varnothing 7/8mm D2 \varnothing 9mm M4R IT 0.9A at 50Hz 230V at 50Hz 2760rpm suitable capacitor 4 μ F type LM63 shaft flat length 17mm		
accessories for	601354		
	GEV No.	365031	Ref. No. —
	operating capacitor capacity 4 μ F 450V tolerance 5% 50/60Hz ambient temperature max. -25 to +85°C \varnothing 31mm L 58mm M8 plastic connection male faston 6.3mm protection		
	GEV No.	601061	Ref. No. —
	fan wheel D1 \varnothing 160mm H1 60mm blades 15 D2 \varnothing 18mm D3 \varnothing 18mm H2 35mm		

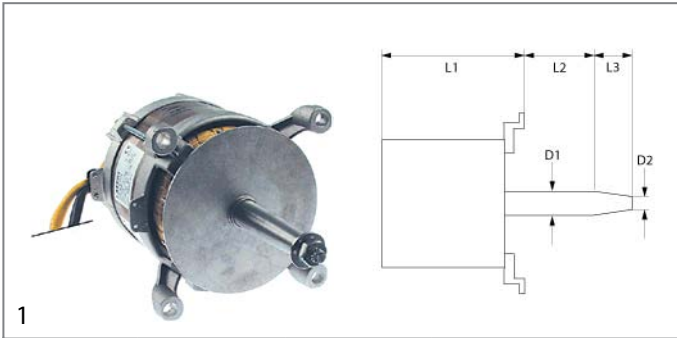

GEV No.	500643	Ref. No.	6034348
description	fan motor 230V 1 phase 50Hz 0.25/0.75kW 670/1370rpm speeds 2 L1 195mm L2 47mm L3 70mm D1 \varnothing 24mm D2 \varnothing 20mm M6R IT 1.5/4.7A suitable capacitor 50/20 μ F Cos(phi) 0.53/0.7 at 50Hz 670/1370rpm 4P/8P type FB100L no. 677325		
For models:	CE102MX, CE20MX, CG102MX, CG20MX, DE102EC, DE102MX, DG102EC, DG102MX, VE102EC, VE102MX, VE20EC, VE20MX, VG102EC, VG102MX, VG20EC, VG20MX		

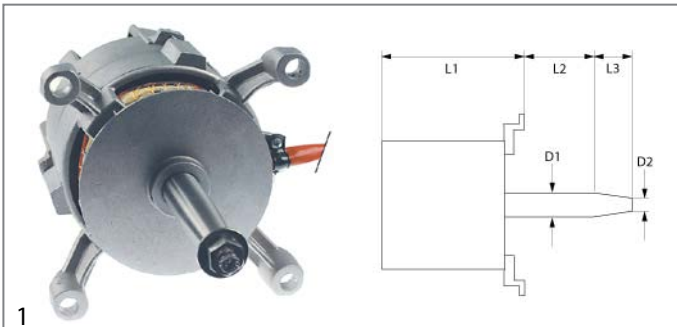

GEV No.	500642	Ref. No.	6033145
description	fan motor 380-415V 3 phase 50Hz 0.22/0.75kW 700/1400rpm speeds 2 L1 166mm L2 45mm L3 67mm D1 \varnothing 24mm D2 \varnothing 20mm M6R ITA at 50Hz 380-415V at 50Hz 700/1400rpm type FB80 4/8 no. 629764		
For models:	DE102EC, DE10EC, DG102EC, EF6PM, EF8PM, VE10EC, VE20EC, VG20EC		



GEV No.	602135	Ref. No.	5901101
description	fan wheel blades 12 D1 \varnothing 180mm D2 \varnothing 8mm D3 \varnothing 6x9mm H1 100mm H2 27mm H3mm		



GEV No.	601202	Ref. No.	5901006
description	fan wheel D1 \varnothing 180mm H1 100mm blades 16 D2 \varnothing 11.5mm D3 \varnothing 16mm H2 30mm		
For models:	CE06MX, CG06MX, DE06EC, DE06ES, DE06MX, DG06EC, DG06ES, DG06MX, VE06EC, VE06MX, VG06EC, VG06MX		



GEV No.	601060	Ref. No.	5900896
description	fan wheel D1 \varnothing 180mm H1 60mm blades 16 D2 \varnothing 11mm D3 \varnothing 16mm H2 30mm		



GEV No.	601246	Ref. No.	5901003
description	fan wheel D1 \varnothing 180mm H1 77mm blades 12 D2 \varnothing 8mm D3 \varnothing 6mm H2 25.5mm		



Зип Обществит

vsezip.ru

+7(812)987-08-81



1

GEV No.	601203	Ref. No.	5901010
description	fan wheel D1 ø 310mm H1 100mm blades 30 D2 ø 19.5mm D3 ø 23mm H2 46mm		
For models:	CE10MX, CG10MX, DE10EC, DE10ES, DE10MX, DG10EC, DG10ES, DG10MX, VE10EC, VE10MX, VG10EC, VG10MX		



1

GEV No.	601204	Ref. No.	5901022
description	fan wheel D1 ø 350mm H1 135mm blades 30 D2 ø 19.5mm D3 ø 23mm H2 46mm		
For models:	CE102MX, DE102EC, VE102EC, VE102MX		

pumps

booster pumps II

accessories



1

GEV No.	365017	Ref. No.	6090015
description	operating capacitor capacity 5µF 450V tolerance 5% 50/60Hz ambient temperature max. -25 to +85°C ø 28mm L 54mm M8 plastic connection male faston 6.3mm 16.10.08 protection		

condensators & interference sup-
pression filters

operating capacitors

plastic



1

GEV No.	365017	Ref. No.	6090015
description	operating capacitor capacity 5µF 450V tolerance 5% 50/60Hz ambient temperature max. -25 to +85°C ø 28mm L 54mm M8 plastic connection male faston 6.3mm 16.10.08 protection		

filters

interference suppression filters



1

GEV No.	365044	Ref. No.	6090050
description	interference suppression filter type FC701Y2F 250V 50-60Hz conductor 2 with E connection cable 200mm L 42mm ø 23mm Hmm Wmm plastic Qty 1 pcs		

gas valves and ignition boxes

gas control valves

SIT

ELETTROSIT



1



GEV No.	101126	Ref. No.	7020060
description	gas valve SIT type ELETTROSIT 230V gas inlet 1/2" gas outlet 1/2" thermocouple connection M9x1 pilot connection M10x1 bottom equiv. no. 0.810.136		
spare parts for	101126		
	GEV No.	101312	Ref. No. 6010054
	microswitch		
	GEV No.	101352	Ref. No. —
	solenoid coil 230V 50Hz suitable for ELETTROSIT		

Table continues overleaf

1 electric components



Зип-Общепит



accessories for		101126	
	GEV No.	100006	Ref. No. —
piezoelectric igniter suitable for ELETTROSIT body plastic blowing connection $\varnothing 2.4\text{mm}$ $\varnothing 14\text{mm}$			
	GEV No.	100904	Ref. No. —
locking screw M10x1 for pipe $\varnothing 4\text{mm}$ Qty 1 pcs			
	GEV No.	100905	Ref. No. 70500z0
locking screw M10x1 for pipe $\varnothing 6\text{mm}$ Qty 1 pcs			
	GEV No.	101301	Ref. No. —
gas connection thread 1/2" straight ELETTROSIT screw with O-ring			
	GEV No.	101303	Ref. No. —
gas connection straight thread 3/4" ELETTROSIT			
	GEV No.	101309	Ref. No. —
extension			

accessories for		101956	
	GEV No.	101308	Ref. No. —
gas connection angled flange 45x45mm hole distance 36x36mm 1/2" ELETTROSIT/V4400/4600/4605 screw with O-ring suitable for SIT/HONEYWELL			
	GEV No.	101312	Ref. No. 6010054
microswitch			
	GEV No.	101314	Ref. No. —
solenoid coil 24V 50Hz			
	GEV No.	101317	Ref. No. —
plug with cable L 1000mm suitable for NOVASIT			
	GEV No.	101318	Ref. No. —
cover cap for solenoid coil suitable for NOVASIT			

NOVASIT



1			
GEV No.	101956	Ref. No.	7020070
description	gas valve SIT series Novasit 820 230V 50Hz gas inlet 1/2" gas outlet 1/2" thermocouple connection M9x1 pilot connection M10x1 ignition pressure range 5-50mbar pressure regulator connection blind equiv. no. 0.820.031		
For models:	13FG, 13FGC, 17FG, 17FGC, 207FG, 207FGC, 213FG, 213FGC, 217FG, 217FGC, 917FG, 917FGC, 927FG, 927FGC, 934FG, 934FGC, FG07CL, FG213CL		
spare parts for	101956		
	GEV No.	101065	Ref. No. —
magnet unit with cable L 44mm D1 $\varnothing 30\text{mm}$ D2 $\varnothing 20\text{mm}$ suitable for NOVASIT			
	GEV No.	101313	Ref. No. —
solenoid coil 230V 50Hz			
accessories for	101956		
	GEV No.	100006	Ref. No. —
piezoelectric igniter suitable for ELETTROSIT body plastic blowing connection $\varnothing 2.4\text{mm}$ $\varnothing 14\text{mm}$			
	GEV No.	101305	Ref. No. —
gas connection straight 1/2" flange 45x45mm ELETTROSIT/V4400/4600/4605 suitable for SIT/HONEYWELL hole distance 36x36mm			
	GEV No.	101306	Ref. No. 7020011
gas connection angled flange 45x45mm hole distance 36x36mm 1/2" ELETTROSIT/V4400/4600/4605 screw with O-ring suitable for SIT/HONEYWELL			
	GEV No.	101307	Ref. No. —
gas connection straight flange 45x45mm hole distance 36x36mm 3/4" ELETTROSIT/V4400/4600/4605 screw with O-ring suitable for SIT/HONEYWELL			

accessories

1			
GEV No.	101306	Ref. No.	7020011
description	gas connection angled flange 45x45mm hole distance 36x36mm 1/2" ELETTROSIT/V4400/4600/4605 screw with O-ring suitable for SIT/HONEYWELL		
spare parts for	101306		
	GEV No.	517104	Ref. No. —
O-ring EPDM thickness 2.62mm ID $\varnothing 31.42\text{mm}$ Qty 1 pcs			

1			
GEV No.	100905	Ref. No.	7050020
description	locking screw M10x1 for pipe $\varnothing 6\text{mm}$ Qty 1 pcs		

1			
GEV No.	101312	Ref. No.	6010054
description	microswitch		

gas components



Зип-Общепит
ignition boxes

vsezip.ru

+7(812)987-08-81

TANDEM



1

GEV No.	101881	Ref. No.	7020080
description	gas valve 230V 50Hz gas inlet 1/2" gas outlet 1/2" pilot connection level slow ignition ignition times pressure range 3-50mbar power supply for modulator equiv. no. 0.830.041 suitable for Tandem		
For models:	CG06MX, CG102MX, CG10MX, CG20MX, DG06EC, DG06ES, DG06MX, DG102EC, DG102MX, DG10EC, DG10ES, DG10MX, GF10GM, GF4PM, GF5GM, GF6PM, GF7GM, GF8PM, VG06EC, VG06MX, VG102EC, VG102MX, VG10EC, VG10MX, VG20EC, VG20MX		
spare parts for	101881		
	GEV No.	101379	Ref. No. —
	solenoid coil 230V 50Hz suitable for Tandem		
accessories for	101881		
	GEV No.	101274	Ref. No. 7070036
	olive for pipe ø 16mm Qty 1 pcs		
	GEV No.	101275	Ref. No. —
	union screw thread 1/2" for pipe ø 16mm Qty 1 pcs		
	GEV No.	101925	Ref. No. —
	plug with O-ring thread M10x1 for pilot burner suitable for NOVASIT		
	GEV No.	102845	Ref. No. —
	gas connection angled 1/2" flange 32x32mm hole distance 24x24mm Tandem		
	GEV No.	102846	Ref. No. —
	gas connection straight 1/2" flange 32x32mm hole distance 24x24mm suitable for Tandem		
	GEV No.	102847	Ref. No. —
	O-ring		

SIT



1

GEV No.	101685	Ref. No.	7020085
description	ignition box SIT type 503EFD electrodes 2 waiting time 1.5s safety time 10s 220/240V 10VA 50-60Hz protection IP40		
For models:	CG06MX, CG102MX, CG10MX, CG20MX, DG06EC, DG06ES, DG06MX, DG102EC, DG102MX, DG10EC, DG10ES, DG10MX, GF10GM, GF4PM, GF5GM, GF6PM, GF7GM, GF8PM, VG06EC, VG06MX, VG102EC, VG102MX, VG10EC, VG10MX, VG20EC, VG20MX		

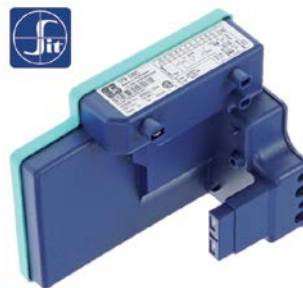

1

GEV No.	107837	Ref. No.	7020206
description	ignition box SIT type 579DBC for combi-steamer suitable for GIORIK equiv. no. 0.579.418 electrodes 2 waiting time 1.5s safety time 5s 220/240V 12VA 50/60Hz		

miscellaneous



1

GEV No.	401171	Ref. No.	6010084
description	ignition box		
For models:	CE06MX, CE102MX, CE10MX, CE20MX, CG06MX, CG102MX, CG10MX, CG20MX, DE06EC, DE06ES, DE06MX, DE102EC, DE102MX, DE10EC, DE10ES, DE10MX, DG06EC, DG06ES, DG06MX, DG102EC, DG102MX, DG10EC, DG10ES, DG10MX, EF4, EF4PM, EF6PM, EF8PM, GF4PM, GF6PM, GF8PM, VE06EC, VE06MX, VE102EC, VE102MX, VE10EC, VE10MX, VE20EC, VE20MX, VG06EC, VG06MX, VG102EC, VG102MX, VG10EC, VG10MX, VG20EC, VG20MX		

2 gas components

ignition parts

pilot burners

SIT

100 series



GEV No.	106906	Ref. No.	7090022
description	pilot burner SIT type 100 series 3 flames nozzle \varnothing 0.2mm gas connection 6mm		
For models:	FG07CL, FG07L, FG13L, FG213CL, FG213L, SG608		
spare parts for	106906		
	GEV No.	100245	Ref. No. 7042005
	pilot burner nozzle LPG code 20 bore \varnothing 0.2mm Qty 1 pcs thread M8x0.75		
	GEV No.	100855	Ref. No. —
	pilot burner bracket triple		
	GEV No.	100885	Ref. No. 7070014 7090007
	air mixing sleeve for pilot burner Qty 1 pcs		
	GEV No.	100916	Ref. No. —
	compression spring for pilot burner Qty 1 pcs		
	GEV No.	100917	Ref. No. —
	gasket for pilot burner Qty 1 pcs aluminium		
	GEV No.	100918	Ref. No. —
	screw for pilot burner		
	GEV No.	107162	Ref. No. 7090002
	pilot burner cap SIT 3 flames Hmm Lmm Qty 1 pcs		
	GEV No.	107701	Ref. No. —
	pilot burner bottom part SIT 100 series nozzle \varnothing 0.2mm		
accessories for	106906		
	GEV No.	100245	Ref. No. 7042005
	pilot burner nozzle LPG code 20 bore \varnothing 0.2mm Qty 1 pcs thread M8x0.75		
	GEV No.	100246	Ref. No. 7042006
	pilot burner nozzle natural gas bore \varnothing 0.35mm Qty 1 pcs thread M8x0.75		
	GEV No.	100904	Ref. No. —
	locking screw M10x1 for pipe \varnothing 4mm Qty 1 pcs		
	GEV No.	100905	Ref. No. 7050020
	locking screw M10x1 for pipe \varnothing 6mm Qty 1 pcs		
	GEV No.	102110	Ref. No. —
	pilot tube copper pipe \varnothing 4mm thickness 1mm L 3000mm		
	GEV No.	102111	Ref. No. —
	pilot tube copper pipe \varnothing 6mm thickness 1mm L 3000mm		

	GEV No.	107171	Ref. No.	—
	pilot burner nozzle SIT natural/liquid gas bore \varnothing 0.25mm Qty 1 pcs			
	GEV No.	107700	Ref. No.	—
	pilot burner bottom part SIT 100 series nozzle \varnothing 0.25mm			
	GEV No.	107702	Ref. No.	—
	pilot burner bottom part SIT 100 series nozzle \varnothing 0.35mm			

	GEV No.	106907	Ref. No.	7090023
	description	pilot burner SIT type 100 series 3 flames nozzle \varnothing 0.35mm gas connection 6mm		
	For models:	13FG, 13FGC, 17FG, 17FGC, 207FG, 207FGC, 213FG, 213FGC, 217FG, 217FGC, 917FG, 917FGC, 927FG, 927FGC, 934FG, 934FGC		
	spare parts for	106907		
	GEV No.	100246	Ref. No.	7042006
	pilot burner nozzle natural gas bore \varnothing 0.35mm Qty 1 pcs thread M8x0.75			
	GEV No.	100855	Ref. No.	—
	pilot burner bracket triple			
	GEV No.	100885	Ref. No.	7070014 7090007
	air mixing sleeve for pilot burner Qty 1 pcs			
	GEV No.	100916	Ref. No.	—
	compression spring for pilot burner Qty 1 pcs			
	GEV No.	100917	Ref. No.	—
	gasket for pilot burner Qty 1 pcs aluminium			
	GEV No.	100918	Ref. No.	—
	screw for pilot burner			
	GEV No.	107162	Ref. No.	7090002
	pilot burner cap SIT 3 flames Hmm Lmm Qty 1 pcs			
	GEV No.	107702	Ref. No.	—
	pilot burner bottom part SIT 100 series nozzle \varnothing 0.35mm			
	accessories for	106907		
	GEV No.	100245	Ref. No.	7042005
	pilot burner nozzle LPG code 20 bore \varnothing 0.2mm Qty 1 pcs thread M8x0.75			
	GEV No.	100904	Ref. No.	—
	locking screw M10x1 for pipe \varnothing 4mm Qty 1 pcs			
	GEV No.	100905	Ref. No.	7050020
	locking screw M10x1 for pipe \varnothing 6mm Qty 1 pcs			
	GEV No.	102110	Ref. No.	—
	pilot tube copper pipe \varnothing 4mm thickness 1mm L 3000mm			





Table continues overleaf





Зип-Общепит

vsezip.ru

+7(812)987-08-81

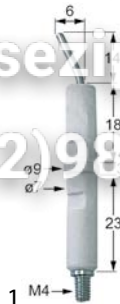
accessories for		106907	
GEV No.	102111	Ref. No.	—
	pilot tube	copper pipe \varnothing 6mm thickness 1mm L 3000mm	
GEV No.	107171	Ref. No.	—
	pilot burner nozzle	SIT natural/liquid gas bore \varnothing 0.25mm Qty 1 pcs	
GEV No.	107700	Ref. No.	—
	pilot burner bottom part	SIT 100 series nozzle \varnothing 0.25mm	
GEV No.	107701	Ref. No.	—
	pilot burner bottom part	SIT 100 series nozzle \varnothing 0.2mm	



GEV No.	100706	Ref. No.	6010046
	description	ignition electrode connection M4 Qty 1 pcs	
For models:	13FG, 13FGC, 17FG, 17FGC, 207FG, 207FGC, 213FG, 213FGC, 217FG, 217FGC, 917FG, 917FGC, 927FG, 927FGC, 934FG, 934FGC, FG07CL, FG07L, FG13L, FG213CL, FG213L, SG608		

accessories			
pilot burner caps			
	1		
GEV No.	107162	Ref. No.	7090002
description	pilot burner cap SIT 3 flames Hmm Lmm Qty 1 pcs		

miscellaneous			
	1		
GEV No.	100885	Ref. No.	7070014 7090007
description	air mixing sleeve for pilot burner Qty 1 pcs		

pilot burner brackets			
universal			
	1		
GEV No.	100888	Ref. No.	7090006
description	screw bolt for pilot burner		

140 - 145 - 150 series				
	1			
GEV No.	107114 ¹	Ref. No.	7090028	
description	pilot burner SIT type 140 series 2 flames nozzle \varnothing mm gas connectionmm			
For models:	CG740, CG780, GG940, GG980			
spare parts for	107114			
	GEV No.	100907	Ref. No.	5900318
description	screw connection thread M10x1 Qty 1 pcs type SEF 1 \varnothing mm for thermocouple			
accessories for	107114			
	GEV No.	100204	Ref. No.	7042014
description	pilot burner nozzle SIT LPG code 14 bore \varnothing 0.18/0.20mm Qty 1 pcs suitable for 140 series			
	GEV No.	100205	Ref. No.	—
description	pilot burner nozzle SIT LPG code 19 bore \varnothing 0.23/0.26mm Qty 1 pcs suitable for SIT 150 series			
	GEV No.	100206	Ref. No.	—
description	pilot burner nozzle SIT natural gas code 36 bore \varnothing 0.60/0.55mm Qty 1 pcs suitable for SIT 150 series			
	GEV No.	100207	Ref. No.	7042013
description	pilot burner nozzle SIT natural gas code 27 bore \varnothing 0.40/0.38mm suitable for SIT 140 series			
	GEV No.	100216	Ref. No.	—
description	pilot burner nozzle SIT natural gas code 38 bore \varnothing 0.45mm Qty 1 pcs suitable for SIT 150 series			
	GEV No.	100701	Ref. No.	6010087
description	ignition electrode connection M4 Qty 1 pcs			

pilot burner nozzles			
	1		
GEV No.	100245	Ref. No.	7042005
description	pilot burner nozzle LPG code 20 bore \varnothing 0.2mm Qty 1 pcs thread M8x0.75		
	1		
GEV No.	100246	Ref. No.	7042006
description	pilot burner nozzle natural gas bore \varnothing 0.35mm Qty 1 pcs thread M8x0.75		

¹incl. thermocouple fitting
Table continues overleaf

Зип-Общепит

vsezip.ru







+7(812)987-08-81

gas components

accessories for		107114	
	GEV No.	100801	Ref. No. —
gasket for pilot burner Qty 1 pcs			
	GEV No.	100897	Ref. No. —
olive for pipe ø 4mm Qty 1 pcs for pilot burner			
	GEV No.	100898	Ref. No. 7070045
olive for pipe ø 6mm Qty 1 pcs for pilot burner			
	GEV No.	100906	Ref. No. 5900317 7050028
screw connection thread M10x1 for ignition electrode brass Qty 1 pcs WS 10			
	GEV No.	100908	Ref. No. —
union screw thread M10x1 for pipe ø 4mm Qty 1 pcs			
	GEV No.	100909	Ref. No. 7050029
union screw thread M10x1 for pipe ø 6mm Qty 1 pcs			
	GEV No.	102110	Ref. No. —
pilot tube copper pipe ø 4mm thickness 1mm L 3000mm			
	GEV No.	102111	Ref. No. —
pilot tube copper pipe ø 6mm thickness 1mm L 3000mm			

POLIDORO
pilot burners



GEV No.	100051	Ref. No.	7090026
description	pilot burner POLIDORO 3 flames code gas connectionmm		
For models:	22CPG, 23CPG, 2CPG, 3CPG, CPG1, CPG1BM, CPG66, FTG100, FTG46, FTG46B, FTG46R, FTG66L, FTG66LG, FTG66R, GG66		
spare parts for	100051		
	GEV No.	100907	Ref. No. 5900318
screw connection thread M10x1 Qty 1 pcs type SEF 1 ømm for thermocouple			
accessories for	100051		
	GEV No.	100000	Ref. No. —
pilot burner nozzle POLIDORO LPG code 22 bore ø 0.22mm Qty 1 pcs			
	GEV No.	100208	Ref. No. —
pilot burner nozzle POLIDORO LPG code 20 bore ø 0.2mm Qty 1 pcs			
	GEV No.	100209	Ref. No. —
pilot burner nozzle POLIDORO natural gas code 40 bore ø 0.4mm Qty 1 pcs			
	GEV No.	100701	Ref. No. 6010087
ignition electrode connection M4 Qty 1 pcs			
	GEV No.	100906	Ref. No. 5900317 7050028
screw connection thread M10x1 for ignition electrode brass Qty 1 pcs WS 10			

accessories for		100051	
	GEV No.	100907	Ref. No. 5900318
screw connection thread M10x1 Qty 1 pcs type SEF 1 ømm for thermocouple			
	GEV No.	100908	Ref. No. —
union screw thread M10x1 for pipe ø 4mm Qty 1 pcs			
	GEV No.	100909	Ref. No. 7050029
union screw thread M10x1 for pipe ø 6mm Qty 1 pcs			
	GEV No.	102110	Ref. No. —
pilot tube copper pipe ø 4mm thickness 1mm L 3000mm			
	GEV No.	102111	Ref. No. —
pilot tube copper pipe ø 6mm thickness 1mm L 3000mm			
	GEV No.	102508	Ref. No. —
union screw thread M10x1 for pipe ø 4mm Qty 5 pcs			
	GEV No.	102509	Ref. No. —
union screw thread M10x1 for pipe ø 6mm Qty 5 pcs			
	GEV No.	102699	Ref. No. —
pilot burner nozzle POLIDORO natural gas code 25.2 bore ø 2x0.25mm Qty 1 pcs 2 bores			
	GEV No.	102795	Ref. No. —
olive for pipe ø 4mm Qty 1 pcs			
	GEV No.	102797	Ref. No. —
olive for pipe ø 6mm Qty 1 pcs			
	GEV No.	106703	Ref. No. 7042008
pilot burner nozzle POLIDORO natural gas code 27.2 bore ø 2x0.27mm Qty 1 pcs			
	GEV No.	106704	Ref. No. —
pilot burner nozzle POLIDORO LPG code 16.2 bore ø 2x0.16mm Qty 1 pcs			
	GEV No.	106763	Ref. No. —
pilot burner nozzle POLIDORO natural gas code 27.2A bore ø 2x 0.27mm Qty 1 pcs			
	GEV No.	106859	Ref. No. —
pilot burner nozzle POLIDORO LPG code 24 bore ø 0.24mm Qty 1 pcs			



	GEV No.	100076	Ref. No.	7090024
1				
description	pilot burner POLIDORO 3 flames natural gas code 29.2 gas connection 6mm			
spare parts for	100076			
	GEV No.	100907	Ref. No.	5900318
screw connection thread M10x1 Qty 1 pcs type SEF 1 ømm for thermocouple				
accessories for	100076			
	GEV No.	100000	Ref. No.	—
pilot burner nozzle POLIDORO LPG code 22 bore ø 0.22mm Qty 1 pcs				

Table continues overleaf



Зип Общежит

electrodes

vsezip.ru

+7(812)987-08-81

accessories for		100076	
GEV No.		100208	Ref. No.
	pilot burner nozzle	POLIDORO LPG code 20 bore \varnothing 0.2mm	Qty 1 pcs
	pilot burner nozzle	POLIDORO natural gas code 40 bore \varnothing 0.4mm	Qty 1 pcs
	ignition electrode connection	M4	Qty 1 pcs
	screw connection	thread M10x1 for ignition electrode brass	Qty 1 pcs WS 10
	screw connection	thread M10x1 Qty 1 pcs type SEF 1 \varnothing mm for thermocouple	
	union screw	thread M10x1 for pipe \varnothing 4mm	Qty 1 pcs
	union screw	thread M10x1 for pipe \varnothing 6mm	Qty 1 pcs
	pilot tube	copper pipe \varnothing 4mm thickness 1mm	L 3000mm
	pilot tube	copper pipe \varnothing 6mm thickness 1mm	L 3000mm
	union screw	thread M10x1 for pipe \varnothing 4mm	Qty 5 pcs
	union screw	thread M10x1 for pipe \varnothing 6mm	Qty 5 pcs
	pilot burner nozzle	POLIDORO natural gas code 25.2 bore \varnothing 2x0.25mm	Qty 1 pcs 2 bores
	olive	for pipe \varnothing 4mm	Qty 1 pcs
	olive	for pipe \varnothing 6mm	Qty 1 pcs
	pilot burner nozzle	POLIDORO natural gas code 27.2 bore \varnothing 2x0.27mm	Qty 1 pcs
	pilot burner nozzle	POLIDORO LPG code 16.2 bore \varnothing 2x0.16mm	Qty 1 pcs
	pilot burner nozzle	POLIDORO natural gas code 27.2A bore \varnothing 2x0.27mm	Qty 1 pcs
	pilot burner nozzle	POLIDORO LPG code 24 bore \varnothing 0.24mm	Qty 1 pcs

GEV No.	100701	Ref. No.	6010087
description	ignition electrode connection M4 Qty 1 pcs		
For models:	SG520		
accessories for	100701		
	GEV No.	100906	Ref. No.
			5900317 7050028
	screw connection thread M10x1 for ignition electrode brass Qty 1 pcs WS 10		



GEV No.	100706	Ref. No.	6010046
description	ignition electrode connection M4 Qty 1 pcs		
For models:	13FG, 13FGC, 17FG, 17FGC, 207FG, 207FGC, 213FG, 213FGC, 217FG, 217FGC, 917FG, 917FGC, 927FG, 927FGC, 934FG, 934FGC, FG07CL, FG07L, FG13L, FG213CL, FG213L, SG608		

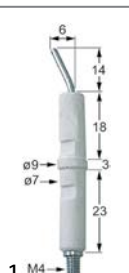

GEV No.	102333	Ref. No.	2012111
description	ignition electrode D1 \varnothing 7mm D2 \varnothing 9mm connection M4 L1 23mm L2 19mm BL1 18mm BL2 3mm BL3 23mm to clip		
For models:	CG06MX, CG102MX, CG10MX, CG20MX, DG06EC, DG06ES, DG06MX, DG102EC, DG102MX, DG10EC, DG10ES, DG10MX, VG06EC, VG06MX, VG102EC, VG102MX, VG10EC, VG10MX, VG20EC, VG20MX		

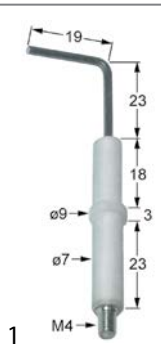

gas components

Зип Общепит

vsezip.ru

+7(812)987-08-81



GEV No.	102331	Ref. No.	2012109
description	ignition electrode D1 ø 7mm D2 ø 9mm connection M4 L1 34mm L2 40mm L3 14mm BL1 18mm BL2 3mm BL3 23mm to clip		
For models:	VG06EC, VG06MX, VG102EC, VG10EC, VG10MX		



GEV No.	102332	Ref. No.	2012108
description	ignition electrode D1 ø 7mm D2 ø 9mm connection M4 L1 40mm L2 46mm BL1 18mm BL2 3mm BL3 23mm to clip		
For models:	VG06EC, VG06MX, VG102EC, VG102MX, VG10EC, VG10MX, VG20EC, VG20MX		



GEV No.	102334	Ref. No.	2012110
description	ignition electrode D1 ø 7mm D2 ø 9mm connection M4 L1 9mm L2 12mm L3 62mm BL1 18mm BL2 3mm BL3 23mm to clip		
For models:	CG06MX, CG102MX, CG10MX, CG20MX, DG06EC, DG06ES, DG06MX, DG102EC, DG102MX, DG10EC, DG10ES, DG10MX, VG06EC, VG06MX, VG102EC, VG102MX, VG10EC, VG10MX, VG20EC, VG20MX		



GEV No.	100906	Ref. No.	5900317 7050028
description	screw connection thread M10x1 for ignition electrode brass Qty 1 pcs WS 10		

ignition cables

pre-assembled cables



GEV No.	100140	Ref. No.	6050051
description	ignition cable cable length 400mm connection ø2.4mm / ø4mm		
For models:	13FG, 13FGC, 17FG, 17FGC, 207FG, 213FG, 213FGC, 217FG, 217FGC, 22CPG, 23CPG, 2CPG, 3CPG, 917FG, 917FGC, 927FG, 927FGC, 934FG, 934FGC, CPG66, FG07CL, FG213CL, FRG46, FRG66, SG608		



GEV No.	100025	Ref. No.	6050065
description	ignition cable cable length 600mm connection ø4mm / F6.3mm		
For models:	FG07L, FG13L, FG213L		



GEV No.	100019	Ref. No.	6050610
description	ignition cable cable length 900mm connection ø2.4mm / ø4mm		

piezoelectric igniters

mounting diameter 22mm



GEV No.	100013	Ref. No.	6010047
description	piezoelectric igniter body plastic blowing mounting ø 22mm connection ø2.4mm cable lengthmm		
For models:	22CPG, 23CPG, 2CPG, 3CPG, CG740, CG780, CPG1, CPG1BM, CPG66, FPG18, FRG46, FRG66, FTG100, FTG46, FTG46B, FTG46R, FTG66L, FTG66LG, FTG66R, GG66, GG940, GG980, PCG46, PCG66, SG520, SG608		

accessories for	100013	GEV No.	100023	Ref. No.	—
					female bullet size 2.3mm 0.5-1.5mm ² CuZn t.max. 125°C Qty 20 pcs



ignition units

			
1			
GEV No.	101002	Ref. No.	6041056
description	ignition unit outputs 2 230VAC dimensions 88x23x34mm mounting distance 73mm inlet F6.3x0.8 outlet F2.8x0.8 0.6VA 50/60Hz		
For models:	13FG, 13FGC, 17FG, 17FGC, 207FG, 207FGC, 213FG, 213FGC, 217FG, 217FGC, 917FG, 917FGC, 927FG, 927FGC, 934FG, 934FGC, FG07CL, FG213CL		

Зип Общежит

vsezip.ru
+7(812)987-08-81

thermocouples with a unimised tip

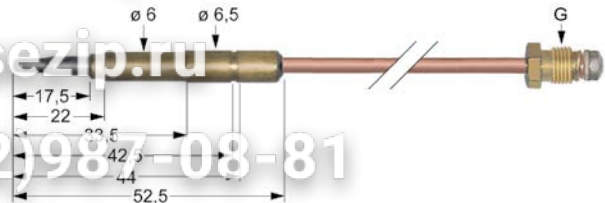
			
1			
GEV No.	102034	Ref. No.	6010063
description	thermocouple M8x1 L 600mm plug connection $\varnothing 6.0(6.5)$ mm		

thermocouples

plug-in thermocouples

plug-in thermocouples standard

with barrel socket $\varnothing 6(6.5)$ mm

thermocouples SIT

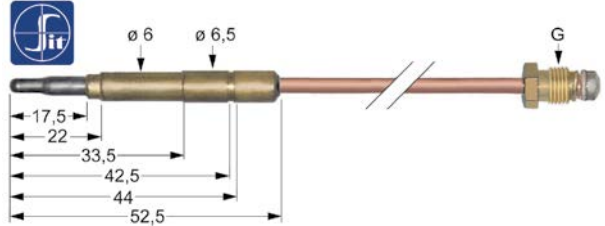
			
1			
GEV No.	107614	Ref. No.	6010056
description	thermocouple SIT M9x1 L 1500mm plug connection $\varnothing 6.0(6.5)$ mm		

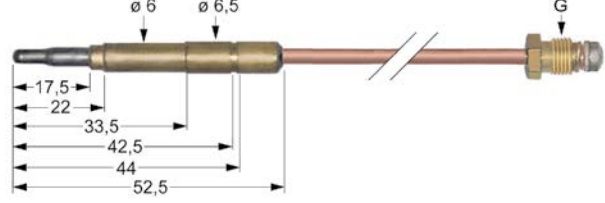
			
1			
GEV No.	102040	Ref. No.	6010058
description	thermocouple M9x1 L 500mm plug connection $\varnothing 6.0(6.5)$ mm		

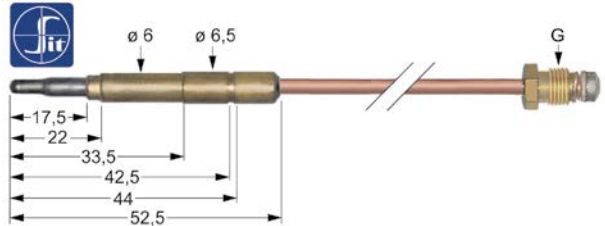
			
1			
GEV No.	107609	Ref. No.	6010055
description	thermocouple SIT M9x1 L 600mm plug connection $\varnothing 6.0(6.5)$ mm		
For models:	13FG, 17FG, 207FG, 213FG, 917FG, 917FGC, 927FG, 927FGC, 934FG, 934FGC, CG740, CG780, FG07L, FG13L, FG213L, FTG100, FTG46, FTG46B, FTG46R, FTG66L, FTG66LG, FTG66R, GG66, GG940, GG980, SG520, SG608		

plug-in thermocouples with interruption

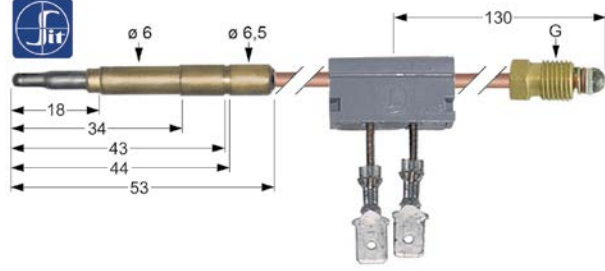
			
1			
GEV No.	107177	Ref. No.	6010065
description	thermocouple SIT with interrupter M9x1 L 600mm plug connection $\varnothing 6.0$ mm F 6.3mm		

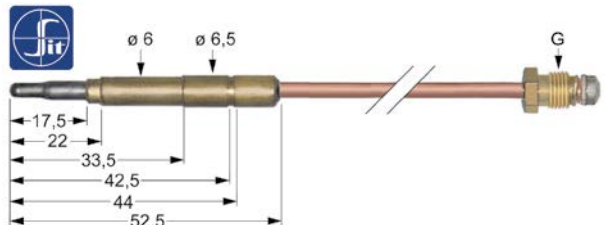
			
1			
GEV No.	107611	Ref. No.	6010057
description	thermocouple SIT M9x1 L 850mm plug connection $\varnothing 6.0(6.5)$ mm		
For models:	22CPG, 23CPG, 2CPG, 3CPG, CPG66		

extensions

			
1			
GEV No.	102811	Ref. No.	6010052
description	thermocouple extension thread M9x1 - M9x1 L 600mm		

accessories

display adapters

			
1			
GEV No.	101337	Ref. No.	7050032
description	display adapter thread M9x1		

gas components

Зип.Общепит
vsezip.ru

+7(812)987-08-81

displays



1

GEV No.	101414	Ref. No.	6010064
description	display soldering connection		

gas burners

bar burners

bar burners



1

GEV No.	105776	Ref. No.	7090100
description	bar burner ø 50mm Wmm Hmm L 305mm with bolt M5x12 flange width 52mm convection oven flange ø 75mm		
For models:	CG06MX, DG06EC, DG06ES, DG06MX, VG06EC, VG06MX		



1

GEV No.	105775	Ref. No.	7090101
description	bar burner ø 50mm Wmm Hmm L 425mm with bolt M5x12 flange width 52mm convection oven flange ø 75mm		
For models:	CG102MX, CG10MX, CG20MX, DG102EC, DG102MX, DG10EC, DG10ES, DG10MX, VG102EC, VG102MX, VG10EC, VG10MX, VG20EC, VG20MX		



1

GEV No.	105774	Ref. No.	7090102
description	bar burner ø 60mm Wmm Hmm L 245mm with bolt M5x12 flange width 67mm flange length 67mm convection oven		
For models:	VG06EC, VG06MX, VG102EC, VG102MX, VG10EC, VG10MX, VG20EC, VG20MX		

pilot burner nozzles

pilot burner nozzles POLIDORO



1

GEV No.	106703	Ref. No.	7042008
description	pilot burner nozzle POLIDORO natural gas code 27.2 bore ø 2x0.27mm Qty 1 pcs		

pilot burner nozzles SIT

100 series



1

GEV No.	100245	Ref. No.	7042005
description	pilot burner nozzle LPG code 20 bore ø 0.2mm Qty 1 pcs thread M8x0.75		



1

GEV No.	100246	Ref. No.	7042006
description	pilot burner nozzle natural gas bore ø 0.35mm Qty 1 pcs thread M8x0.75		

140/150 series



1

GEV No.	100204	Ref. No.	7042014
description	pilot burner nozzle SIT LPG code 14 bore ø 0.18/0.20mm Qty 1 pcs suitable for 140 series		



1

GEV No.	100207	Ref. No.	7042013
description	pilot burner nozzle SIT natural gas code 27 bore ø 0.40/0.38mm suitable for SIT 140 series		

screw connections

olives



1



GEV No.	106426	Ref. No.	7070025
description	olive		





Зип Общепит

vsezip.ru

+7(812)987-08-81

			
1			
GEV No.	101274	Ref. No.	7070036
description	olive for pipe ø 16mm Qty 1 pcs		
accessories for	101274		
	GEV No.	101275	Ref. No.
			—
	union screw thread 1/2" for pipe ø 16mm Qty 1 pcs		

			
1			
GEV No.	100898	Ref. No.	7070045
description	olive for pipe ø 6mm Qty 1 pcs for pilot burner		
accessories for	100898		
	GEV No.	100909	Ref. No.
			7050029
	union screw thread M10x1 for pipe ø 6mm Qty 1 pcs		

			
1			
GEV No.	100909	Ref. No.	7050029
description	union screw thread M10x1 for pipe ø 6mm Qty 1 pcs		
accessories for	100909		
	GEV No.	100898	Ref. No.
			7070045
	olive for pipe ø 6mm Qty 1 pcs for pilot burner		
	GEV No.	101286	Ref. No.
			—
	olive ID ø 6mm Qty 1 pcs		
	GEV No.	101287	Ref. No.
			—
	olive for pipe ø 6mm Qty 1 pcs		
	GEV No.	101288	Ref. No.
			—
	olive for pipe ø 6mm L 6mm aluminium Qty 1 pcs ED ø 8.5mm		

union screws

			
1			
GEV No.	100905	Ref. No.	7050020
description	locking screw M10x1 for pipe ø 6mm Qty 1 pcs		

			
1			
GEV No.	100906	Ref. No.	5900317 7050028
description	screw connection thread M10x1 for ignition electrode brass Qty 1 pcs WS 10		

			
1			
GEV No.	100907	Ref. No.	5900318
description	screw connection thread M10x1 Qty 1 pcs type SEF 1 ømm for thermocouple		

pressure switches

			
1			
GEV No.	541073	Ref. No.	7050012
description	pressure control ø 45mm pressure range adjustable 5-20mbar pressure connection vertical gas technology connection 1/4" pressure connection ø 1/4"mm		

doors

			
1			
GEV No.	690585	Ref. No.	2011212
description	bush for door mechanism L 35mm ED ø 36mm int. ø 1 31mm int. ø 2 13mm mounting distance 28mm brass		
For models:	CE06MX, CE102MX, CE10MX, CE20MX, CG06MX, CG102MX, CG10MX, CG20MX, DE06EC, DE06ES, DE06MX, DE102EC, DE102MX, DE10EC, DE10ES, DE10MX, DG06EC, DG06ES, DG06MX, DG102EC, DG102MX, DG10EC, DG10ES, DG10MX, VE06EC, VE06MX, VE102EC, VE102MX, VE10EC, VE10MX, VE20EC, VE20MX, VG06EC, VG06MX, VG102EC, VG102MX, VG10EC, VG10MX, VG20EC, VG20MX		

2 gas components

door mechanics

miscellaneous



GEV No.	690585	Ref. No.	2011212
description	bush for door mechanism L 35mm ED ø 36mm int. ø 1 31mm int. ø 2 13mm mounting distance 28mm brass		
For models:	CE06MX, CE102MX, CE10MX, CE20MX, CG06MX, CG102MX, CG10MX, CG20MX, DE06EC, DE06ES, DE06MX, DE102EC, DE102MX, DE10EC, DE10ES, DE10MX, DG06EC, DG06ES, DG06MX, DG102EC, DG102MX, DG10EC, DG10ES, DG10MX, VE06EC, VE06MX, VE102EC, VE102MX, VE10EC, VE10MX, VE20EC, VE20MX, VG06EC, VG06MX, VG102EC, VG102MX, VG10EC, VG10MX, VG20EC, VG20MX		

knoobs

producer-specific knobs

GIORIK



GEV No.	112265	Ref. No.	2008671
description	knob gas tap with ignition flame t.max.°C ø 76mm shaft ø 10x8mm shaft flat upper black		
For models:	22CPG, 23CPG, 2CPG, 3CPG, CG740, CG780, CPG1, CPG1BM, CPG66, GG66, GG940, GG980		



GEV No.	111738	Ref. No.	2012261
description	knob switch zero mark ø 50mm shaft ø 6x4.6mm shaft flat left black		
For models:	CE06MX, CE102MX, CE10MX, CE20MX, CG06MX, CG102MX, CG10MX, CG20MX, DE06EC, DE06ES, DE06MX, DE102EC, DE102MX, DE10EC, DE10ES, DE10MX, DG06EC, DG06ES, DG06MX, DG102EC, DG102MX, DG10EC, DG10ES, DG10MX, SH510P, SH560P, VE06EC, VE06MX, VE102EC, VE102MX, VE10EC, VE10MX, VE20EC, VE20MX, VG06EC, VG06MX, VG102EC, VG102MX, VG10EC, VG10MX, VG20EC, VG20MX		



GEV No.	111508	Ref. No.	2006823
description	knob switch zero mark ø 50mm shaft ø 6x4.6mm shaft flat left white		
For models:	13FGC, 15FEC, 17FGC, 207FGC, 20FEC, 210FEC, 213FGC, 215FEC, 217FGC, 220FEC, 917FGC, 920FEC, 922FEC, 927FGC, 934FGC, 940FEC, EF10GM, EF5GM, EF7GM, EN10VE-EC-ESN1033, F10CL, F15CL, F215CL, FG07CL, FG213CL, GF10GM, GF5GM, GF7GM, SH505R, SH510R, SH520G, SH520GM		

Зип Общепит

vsezip.ru

+7(812)987-08-81

GEV No.	111739	Ref. No.	2012260
description	knob universal ø 50mm shaft ø 6x4.6mm shaft flat vertical universal		
For models:	DE06EC, DE102EC, DE10EC, DG06EC, DG102EC, DG10EC, SH510P, VE06EC, VE102EC, VE10EC, VE20EC, VG06EC, VG102EC, VG10EC, VG20EC		

accessories

button springs



GEV No.	550965	Ref. No.	5900242
description	knob spring ø 6x4.6mm Qty 1 pcs		
For models:	BME46, BME66, CPE66, FRE46, FRE46F, FRE46R, FRE46T, FRE66, FRE66F, FRE66R, FRE66T, FTE100, FTE107, FTE46, FTE46B, FTE46R, FTE47L, FTE66L, FTE66LB, FTE66LM, FTE66LMB, FTE66R, FTE66RM, FTE67L, FTE67LM, PCE46, PCE66M, PCE66T, PCG46, PCG66, SPE46		



GEV No.	550132	Ref. No.	550965
description	knob spring ø 6x4.6mm Qty 10 pcs		

locks

handle latches

universal

outside fixing

locks





GEV No.	694065	Ref. No.	5900125	
description	door handle for headed units L 145mm W 40mm H 62mm spring length 33mm outer black			
spare parts for	694065			
	GEV No.	514390	Ref. No.	—
	spring for door handle ø 6mm L 54mm W 27.5mm			
	GEV No.	694734	Ref. No.	—
	door handle L 165mm W 40mm H 25mm black			

Table continues overleaf





Зип Общепит

product specific

vsezip.ru

7(812)987-08-81

spare parts for 694065			
	GEV No.	694735	Ref. No. —
cap ø 32mm black			
accessories for 694065			
	GEV No.	694066	Ref. No.
door catch with spigot 2-stage L 28mm W 14mm H 15mm, H1 16mm total length 51mm thread M8 thread L 23mm stainless steel			
	GEV No.	694067	Ref. No. 5900124
door catch with spigot 1-stage L 26mm total length 51mm thread M8			

GIORIK			
	GEV No.	690585	Ref. No. 2011212
description bush for door mechanism L 35mm ED ø 36mm int. ø 1 31mm int. ø 2 13mm mounting distance 28mm brass			
For models: CE06MX, CE102MX, CE10MX, CE20MX, CG06MX, CG102MX, CG10MX, CG20MX, DE06EC, DE06ES, DE06MX, DE102EC, DE102MX, DE10EC, DE10ES, DE10MX, DG06EC, DG06ES, DG06MX, DG102EC, DG102MX, DG10EC, DG10ES, DG10MX, VE06EC, VE06MX, VE102EC, VE102MX, VE10EC, VE10MX, VE20EC, VE20MX, VG06EC, VG06MX, VG102EC, VG102MX, VG10EC, VG10MX, VG20EC, VG20MX			

snap locks

universal

	GEV No.	690596	Ref. No. 2000160
description snap lock L 60mm W 15mm H 36mm mounting distance 48/28mm spring thickness 1.5mm complete with door catch zamak			

	GEV No.	690041	Ref. No. 5900121
description cam L 148mm mounting distance 32mm			

espagnolette locks

universal

	GEV No.	690041	Ref. No. 5900121
description cam L 148mm mounting distance 32mm			

	GEV No.	690040	Ref. No. 5900122
description door catch with roller H 42mm L 40mm W 40mm zinc die cast mounting distance 26mm type 0751 series			
For models: CE06MX, CE102MX, CE10MX, CE20MX, CG06MX, CG102MX, CG10MX, CG20MX, DE06EC, DE06ES, DE06MX, DE102EC, DE102MX, DE10EC, DE10ES, DE10MX, DG06EC, DG06ES, DG06MX, DG102EC, DG102MX, DG10EC, DG10ES, DG10MX, VE06EC, VE06MX, VE102EC, VE102MX, VE10EC, VE10MX, VE20EC, VE20MX, VG06EC, VG06MX, VG102EC, VG102MX, VG10EC, VG10MX, VG20EC, VG20MX			

	GEV No.	690040	Ref. No. 5900122
description door catch with roller H 42mm L 40mm W 40mm zinc die cast mounting distance 26mm type 0751 series			
For models: CE06MX, CE102MX, CE10MX, CE20MX, CG06MX, CG102MX, CG10MX, CG20MX, DE06EC, DE06ES, DE06MX, DE102EC, DE102MX, DE10EC, DE10ES, DE10MX, DG06EC, DG06ES, DG06MX, DG102EC, DG102MX, DG10EC, DG10ES, DG10MX, VE06EC, VE06MX, VE102EC, VE102MX, VE10EC, VE10MX, VE20EC, VE20MX, VG06EC, VG06MX, VG102EC, VG102MX, VG10EC, VG10MX, VG20EC, VG20MX			

	GEV No.	690584	Ref. No. 2013218
description door handle L 190mm W 41.5mm metal mounting distance 55mm flange 45x72mm shaft 8x8mm shaft L 47mm			

	GEV No.	700771	Ref. No. 5900123
description latch gear opening to the left shaft intake ø 8x8mm L 170mm W 40mm H 40mm			

miscellaneous

	GEV No.	511482	Ref. No. 2006619
description pressure pin L 52mm thread M10x1.5			
For models: EF10GM, EF4PM, EF5GM, EF6PM, EF7GM, EF8PM, EN10VE-EC-ESN1033, GF10GM, GF4PM, GF5GM, GF6PM, GF7GM, GF8PM			

mechanical components, equipment accessories

gaskets

gaskets for heated units

window seals

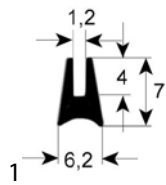

GEV No.	900440	Ref. No.	7070167
description	window gasket profile 1520 Qty supplied by meter		
For models:	CE06MX, CE102MX, CE10MX, CE20MX, CG06MX, CG102MX, CG10MX, CG20MX, DE06EC, DE06MX, DE102EC, DE102MX, DE10EC, DE10MX, DG06EC, DG06MX, DG102EC, DG102MX, DG10EC, DG10MX, VE06EC, VE06MX, VE102EC, VE102MX, VE10EC, VE10MX, VE20EC, VE20MX, VG06EC, VG06MX, VG102EC, VG102MX, VG10EC, VG10MX, VG20EC, VG20MX		

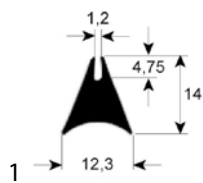

GEV No.	900058	Ref. No.	7070161
description	window gasket profile 1620 Qty supplied by meter		

door seals

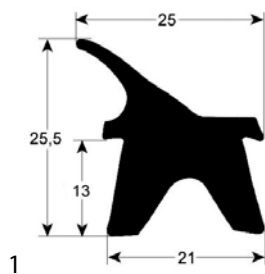

GEV No.	900348	Ref. No.	7070162 7070170 7070172 7070185
description	door seal profile 2402 Qty supplied by meter		
For models:	EF10GM, EF4, EF4PM, EF5GM, EF8PM, GF10GM, GF4PM, GF5GM, GF8PM		

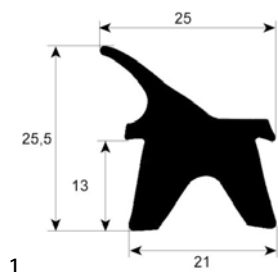

GEV No.	901351	Ref. No.	7070173
description	door seal profile 2402 W 490mm L 635mm external size		

Зип Общепит

vsezip.ru

+7(812)987-08-81

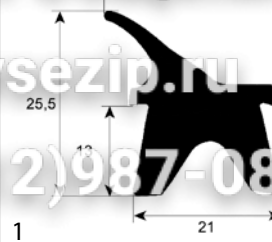

GEV No.	901158	Ref. No.	7070174
description	door seal profile 2402 W 640mm L 740mm		
For models:	EN10VE-EC-ESN1033		

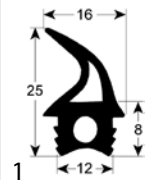

GEV No.	902409	Ref. No.	7070100
description	door seal profile 2714 Qty supplied by meter suitable for GIORIK		

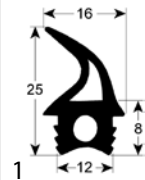

GEV No.	902410	Ref. No.	7070194
description	door seal profile 2714 W 438mm L 778mm suitable for GIORIK		

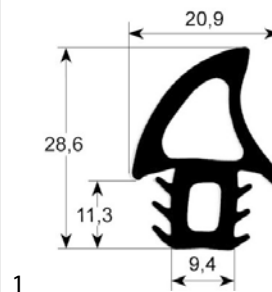

GEV No.	900439	Ref. No.	7070166
description	door seal profile 2750 Qty supplied by meter		
For models:	CE06MX, CE102MX, CE10MX, CE20MX, CG06MX, CG102MX, CG10MX, CG20MX, DE06EC, DE06ES, DE06MX, DE102EC, DE102MX, DE10EC, DE10ES, DE10MX, DG06EC, DG06ES, DG06MX, DG102EC, DG102MX, DG10EC, DG10ES, DG10MX, VE06EC, VE06MX, VE102EC, VE102MX, VE10EC, VE10MX, VE20EC, VE20MX, VG06EC, VG06MX, VG102EC, VG102MX, VG10EC, VG10MX, VG20EC, VG20MX		



3ип Общепит

vsezip.ru

+7(812)987-08-81

O-rings

EPDM

ø1.78mm

1

GEV No.	505045	Ref. No.	5900381
description	O-ring EPDM thickness 1.78mm ID ø 5.28mm Qty 1 pcs		

1

GEV No.	550550	Ref. No.	7070151
description	shaft sealing for fan motor		
For models:	CE102MX, CE10MX, CE20MX, CG102MX, CG10MX, CG20MX, DE102EC, DE102MX, DE10EC, DE10ES, DE10MX, DG102EC, DG102MX, DG10EC, DG10ES, DG10MX, VE102EC, VE102MX, VE10EC, VE10MX, VE20EC, VE20MX, VG102EC, VG102MX, VG10EC, VG10MX, VG20EC, VG20MX		

Viton

ø2.62mm

1

GEV No.	532649	Ref. No.	6090141
description	O-ring Viton ID ø 63.17mm thickness 2.62mm Qty 1 pcs		
For models:	EF10GM, EF4PM, EF5GM, EF6PM, EF7GM, EF8PM, GF10GM, GF4PM, GF5GM, GF6PM, GF7GM, GF8PM		

hose reels and spray guns

spray guns

1

GEV No.	542964	Ref. No.	7080010
description	spray gun for appliances 1/2" ET L 135mm		

ø3.53mm

1

GEV No.	525313	Ref. No.	6090140
description	O-ring Viton ID ø 60.33mm thickness 3.53mm Qty 1 pcs		
For models:	EF10GM, EF4PM, EF5GM, EF6PM, EF7GM, EF8PM, GF10GM, GF4PM, GF5GM, GF6PM, GF7GM, GF8PM		

hoses

industrial hoses

PE hoses

1

GEV No.	520549 ¹	Ref. No.	7090128 7090130
description	hose 1m operating p. 6bar burst p. 10bar t.max. 65°C LLDPE transparent ID ø 6mm ED ø 8mm John Guest supplied by meter		

¹by the meter

shaft gaskets

shaft gaskets

1

GEV No.	550549	Ref. No.	7070150
description	shaft sealing for fan motor		
For models:	CE06MX, CG06MX, DE06EC, DE06ES, DE06MX, DG06EC, DG06ES, DG06MX, VE06EC, VE06MX, VG06EC, VG06MX		

PVC hoses

PVC braided hoses

1

GEV No.	520544	Ref. No.	7090122
description	PVC braided hose ID ø 19mm ED ø 27mm L 5m thickness 4mm operating p. 10bar burst p. 30bar t.max. 60°C PVC warewashing Qty 5m		

mechanical components, equipment accessories



silicone hoses

with fabric

with monofilament braid

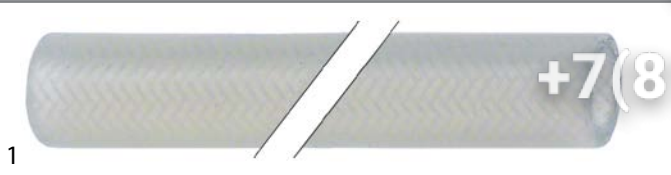

1

GEV No.	530693	Ref. No.	7090112
description	silicone hose with monofilament braid ID ø 10mm ED ø 17mm L 1m thickness 3.5mm operating p. 4bar t.max. 200°C Qty 1m		

Зип.Общепит
fastening material

screws

hexagonal screws



1

GEV No.	550682	Ref. No.	5111109
description	hexagonal screw thread M8 thread L 20mm SS WS 13 Qty 1 pcs DIN 933 / ISO 4017		

fittings, hose and pipe connectors

fittings

angle pieces

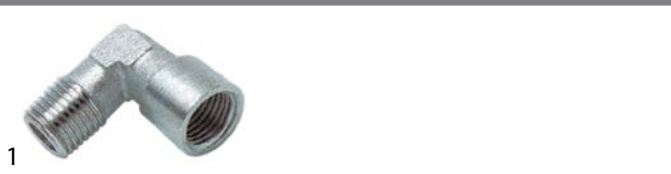

1

GEV No.	520824	Ref. No.	7050374
description	angle piece thread 1/8" ET - 1/8" IT nickel-plated brass		

valves and tank inlets

ball valves

ball valves electric

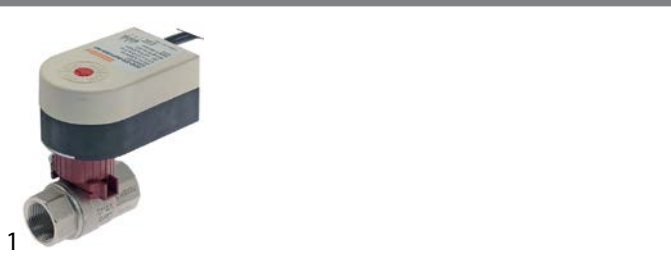

1

GEV No.	401139	Ref. No.	6042073
description	ball valve inlet 3/4" IT outlet 3/4" IT with plug 230V L 65mm 50/60Hz closed off-current mode of operation electric connection cable 200mm		

Зип Общепит

vsezip.ru

indicator lights (complete)

7

industrial hoses

33

A

alarm devices 10

axial fans 17

B

ball valves 34

ball valves electric 16, 34

bar burners 28

booster pumps II 19

C

cam switches 6

condensators & interference suppression filters 19

contactors 10

control thermostats 3

D

door seals 32

E

electric timers 10

electrodes 16

electronic controllers 13

energy regulators 3

espagnolette locks 31

F

fans 17

fastening material 34

filters 19

fittings 34

G

gas burners 28

gas control valves 19

gas nozzles 28

gaskets for heated units 32

H

halogen lamp 8

heating elements 2

heating elements for convection 2

hexagonal screws 34

hoses 33

hot air motors 17

I

ignition boxes 21

ignition cables 26

ignition units 27

immersion heating elements 2

indicator lights 7

L

lamps 7

light bulbs 7

M

mechanical timers 10

microswitches 5

O

operating capacitors 19

O-rings 33

oven lamps 8

P

PE hoses 33

piezoelectric igniters 26

pilot burners 22

pressure switches 16, 29

probes 14

pumps 19

push/momentary push switches 5

PVC hoses 33

R

relays 11

rocker/momentary rocker switches 4

rotary switches 6

S

safety thermostats 3

screws 34

shaft gaskets 33

silicone hoses 34

snap locks 31

solenoid valves 15

spray guns 33

spray guns with external thread 33

switches and momentary switches 4

T

temperature probes 14

thermocouples 27

thermostats 3

time relays 12

timers 10

transformers 13

U

universal probes 14

Зип Общепит**V**

valves and tank inlets

34

vsezip.ru**W**

window seals

+7(812)987-08-81