

Model 601015

Table SPMULTI200 Page 1 Exploded view structure

Pos.	Spare Part	Alias Code	Repl. by	S	Info	Kit	Techn. Bulletin	Description	Notes
0001	0D5131	30147						SHAFT; W/COTTER PIN	
0002	0HD008	21887						KEY 5 PCS	
0003	000000								
0004	0D3578	30049						O-RING 47X3 (SET X5)	
0005	0KI998	18125		S	A			RING; 28X40X7MM; FOR TRS; 5 PCS	
0006	0KI590	3047						BALL BEARING; 6303 2RS1	
0007	0D5107	22885						PIVOT; TRX	
0008	000000								
0009	0D3567	30038			D			BRASS EARTH TERMINAL (SET X5)	
0010	0D0520	21586						PIN; 10 PCS	
0010	0D0610	21841						K35 SCREW TC 4X8	
0011	0KJ007	3041		S	A			BALL BEARING; 6203 2 RS	
0012	0D1669	22889		S	A			BELT	
0012	0D2600	23706			A			POLY V BELT 660 J6	
0013	0D5132	30148			D			SCREW; M5*12 IX; 10 PCS	
0014	000000								
0015	0D0587	21805			D			SET OF 10 PCS NUTS NYLOC M12	
0015	0D1005	26045			D			WASHER; 10 PCS	
0016	000000								
0017	000000								
0018	000000	23115							
0019	0D5133	30149			D			SCREW; M5*25 IX; 10 PCS	
0020	000000								
0021	0KQ366	4268						PULLEY	
0022	0D0551	21724						SCREW; 10 PCS	
0023	0D0757	22866			D			MULTI200 MOTOR SUPPORT PLATE	
0024	034196	26024			D			SCREW 5X8MM; 10 PCS	
0024	0D0546	21696						WASHER; 10 PCS	
0025	0KJ006	12062						MAGNET DETECTOR SWITCH; T10S/T15S K35.55	
0026	033986	21588						SCREW; 10 PCS	
0026	033987	21796						SCREW; 10 PCS	
0026	0D0608	21839						SCREW; 10 PCS	
0027	000000								
0028	0D0764	22919						MULTI200 MOTOR ROOL	
0029	0KQ309	5190						SAFETY SWITCH	
0030	0U0354	4272			A			SWITCH MOUNTING BLOCK	

Pos.	Spare Part	Alias Code	Repl. by	S	Info	Kit	Techn. Bulletin	Description	Notes
Model	601015								
Table	SPMULTI200 Page 1 Exploded view structure								
0031	0D3621	4275						RESSORT TRS	
0032	0KQ485	21921			D			CIRCLIP; 10 PCS	
0033	000000								
0034	0KQ521	21526			A			SEAL; 10 PCS	
0035	000000								
0036	000000								
0037	0KJ586	23393						CONTROL BOARD; WITH PUSH-BUTTONS	
0038	0KR665	24046	0D7662					PLASTIC CAP	
0039	0D0391	18649						BERMIXER RUBBER PLUG/STRAIGHT	
0040	0KL072	16418		S	A			COMMUTATOR 3 PHASE	
0041	0D3469	29295		S	A			TIMER/POTENTIOMETER. BUTTON KIT	
0042	0D1095	28279						MULTI200 POTENTIOMET.CARD 115V	
0042	0KQ424	23546			A			POTENTIOMETER CONTROL CARD	
0043	000000								
0043	0D5312	30179						SUPPLY CABLE; STD- TRX	
0043	0D5313	30180			D			SUPPLY CABLE; USA - TRX	
0043	0D5314	30181			D			SUPPLY CABLE; AUS. - TRX	
0043	0D5315	30182						SUPPLY CABLE; CRYPTO- TRX	
0044	0D5922	24314			D			SUPPORT; MOTEUR/VARIATEUR TRX	
0045	0KQ426	23541			A			FREQUENCY CONVERTER	
0046	0D0930	24302						MULTI200 TIMER CONTACT	
0046	0D0931	24315						MULTI200 CONTACT ASSY	
0047	0D0817	23290						XBE10 VOLTAGE CONVECTOR	
00S1	0D0852	23545						MULTI/TR200 BODY ASSEMBLY	
00S2	0KJ723	23538						SET OF SEALS	
00S3	000000	23537							
00S4	033105	4266		S				PULLEY	
00S5	000000	23542							
00S6	0D2690	24348						MOTOR ASSY SINGLE PH TRX	
00S6	0D2691	24349						MOTOR ASSY THREE PH TRX	
00S7	000000	23539							
00S8	0U0708	23547			A			MICROSWITCH	
00S9	0D0951	24649						MULTI ELECT.VARIATION KIT 115V	

Vue éclatée - Trémie fouloir / Exploded view hopper and feed arm /
Explosionszeichnung - Trichter mit Druckhebel / Esploso - Tramoggia
pestello / Despiece - Tolva pisón

+7(812)987-08-81

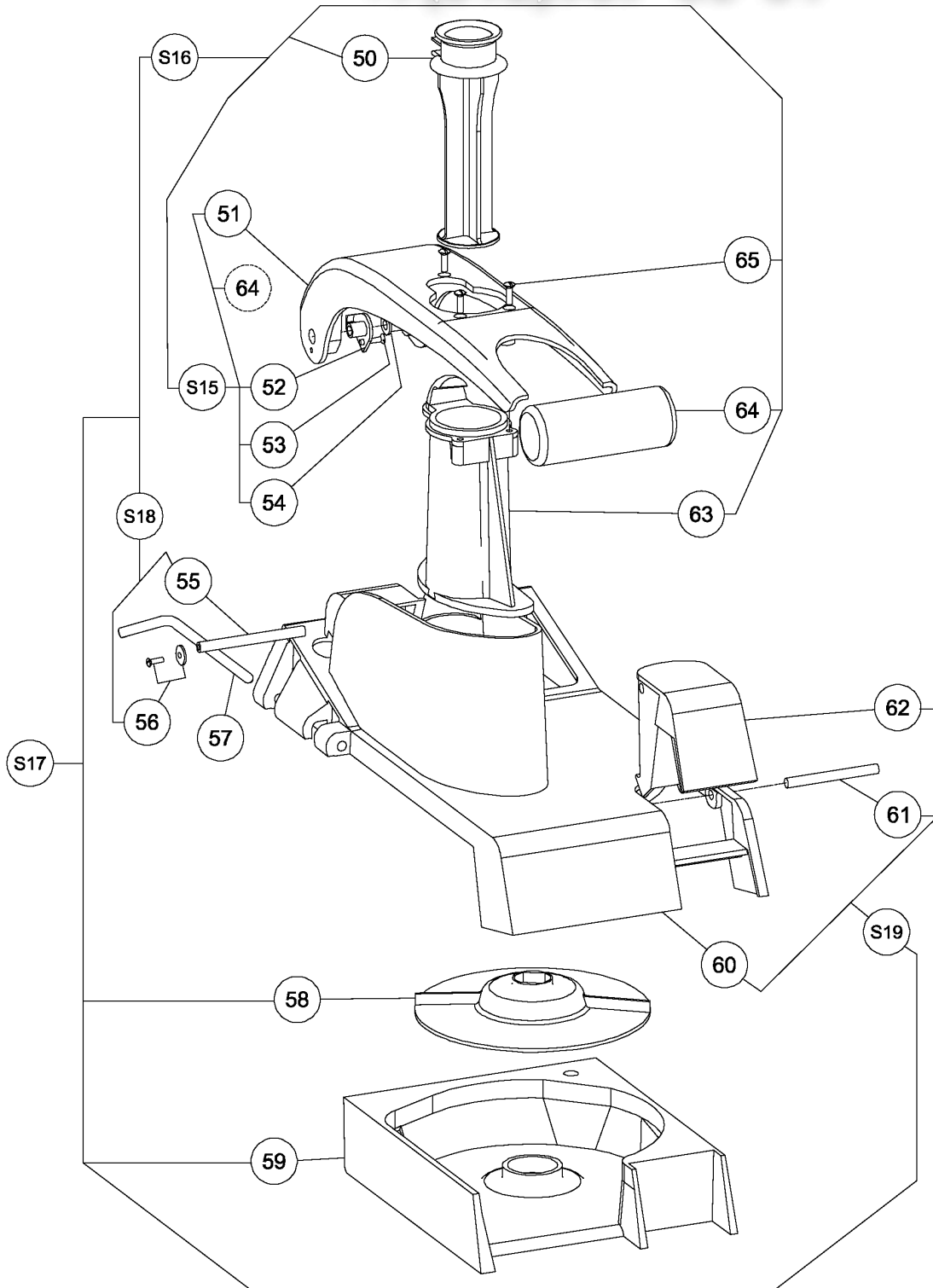

Pos.	Spare Part	Alias Code	Repl. by	S	Info	Kit	Techn. Bulletin	Description	Notes
0050	000000	18272							
0051	000000								
0052	000000	4259							
0053	0D0643	21908						SCREW; 10 PCS	
0054	0KJ599	18153		S	A			BUSHING; 5 PCS	
0055	000000								
0056	0D0643	21908						SCREW; 10 PCS	
0056	0D2327	21872						MILLED WASHER 14X4.5 SET X5	
0057	0D1583	22877						HINGE PIN	
0058	0KJ002	31003						EJECTOR DISK	
0059	0KQ458	22883						REMOVABLE CUTTING CHAMBER	
0060	000000								
0061	033596	4258		S	A			PIN	
0062	0D0758	22875						LOCKING HANDLE MULTI 200	
0063	000000								
0064	000000								
0065	000000								
0S15	0U0446	8047		S	A			PLASTIC CAM	
0S16	0KQ425	23544						FEED ARM ASSEMBLY MULTI 200	
0S17	653287	23460	650064					LEVER-OPERATED HOPPER	
0S18	000000	23543							
0S19	0D5134	30158			D			HOPPER	

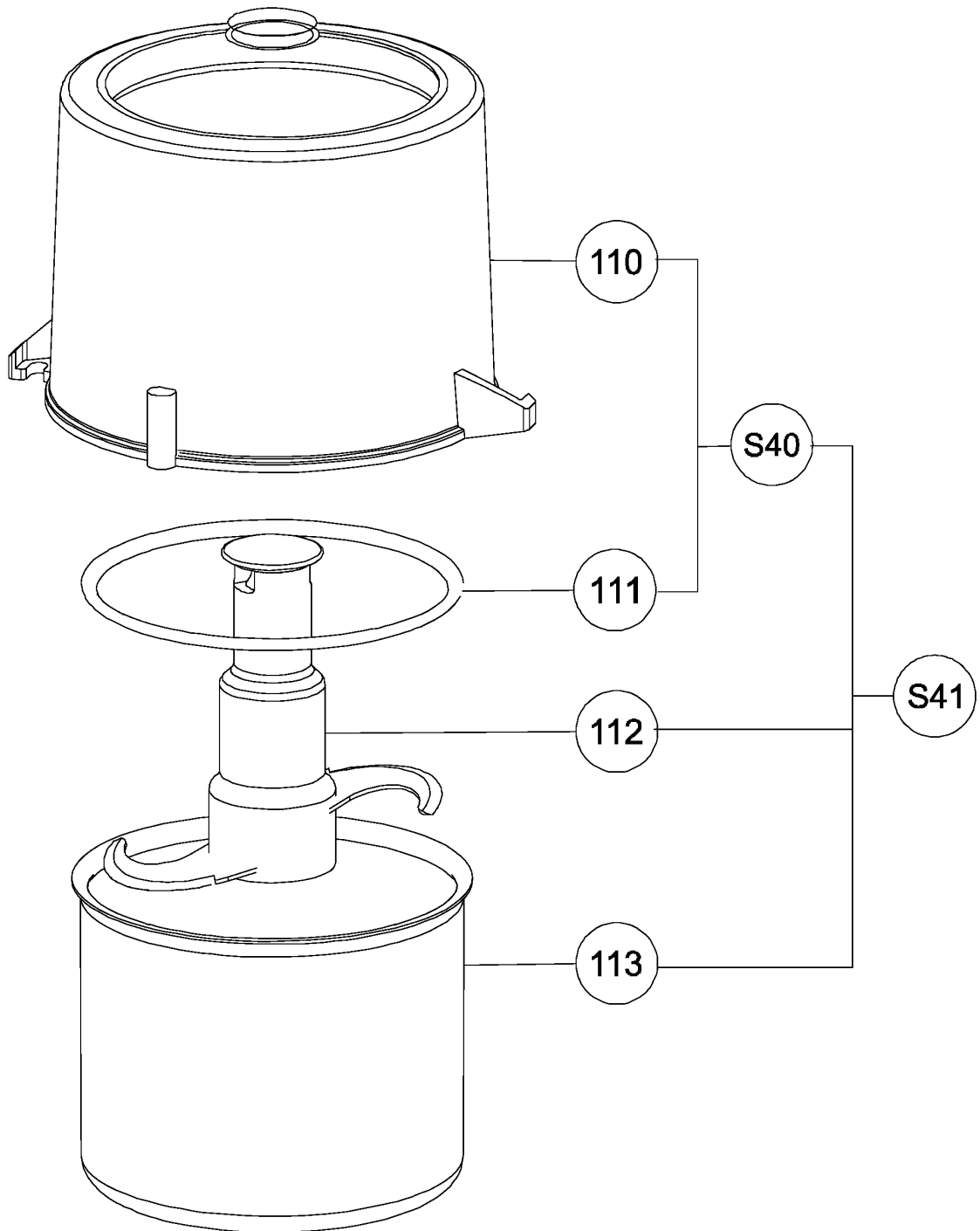

Зип Общепит

Model 601015
 Table SPMULTI200 Page 3 Exploded view cutter

Pos.	Spare Part	Alias Code	Repl. by	S	Info	Kit	Techn. Bulletin	Description	Notes
0110	000000								
0111	OKJ724	22894			A			COVER SEAL MULTI 200	
0112	000000	24192							
0112	653288	23461						3.5L CUTTER WITH SMOOTH BLADES	
0113	653281	23226						3.5L STAINLESS STEEL BOWL	
0S40	OKL083	24120						CUTTER COVER MULTI 200	
0S41	653288	23461						3.5L CUTTER WITH SMOOTH BLADES	

Platine électrique bi-vitesse / electric platinum bi-speed / elektrisches Platin Bi-Geschwindigkeit / platino elettrico vi-velocità / platino eléctrico Bivelocidad

+7(812)987-08-81

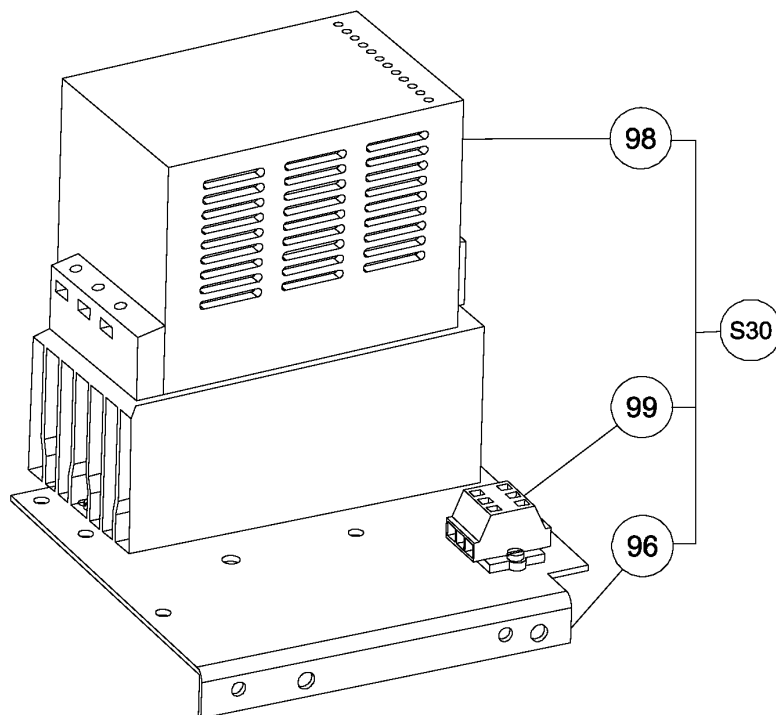
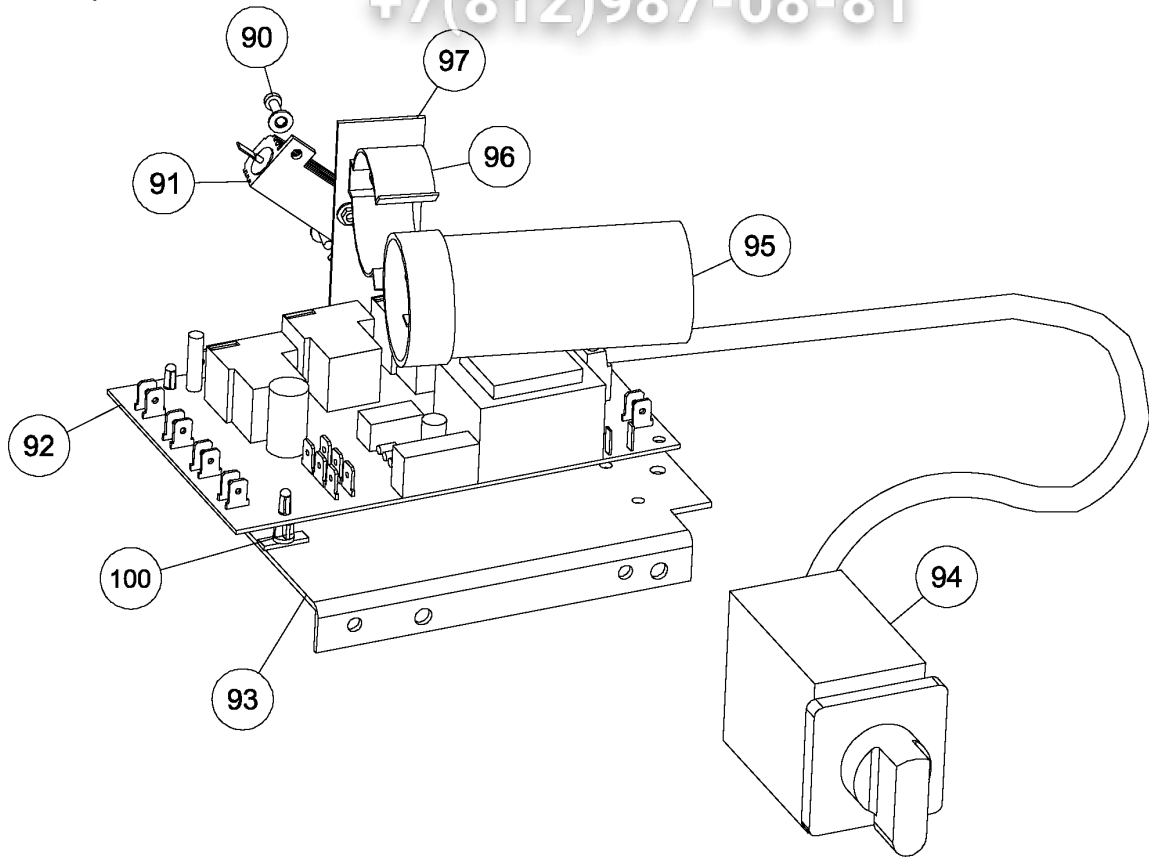

Platine électrique vitesse variable / electric platinum variable speed / elektrisches Platin veränderliche Geschwindigkeit / platino elettrico velocità variable / platino eléctrico velocidad variable

Model 601015
 Table SPMULTI200 Page 4 electric platinum bi-speed / electric platinum variable speed

Pos.	Spare Part	Alias Code	Repl. by	S	Info	Kit	Techn. Bulletin	Description	Notes
0090	0D5136	30160			D			SCREW; C 3*12 NYLON; 10 PCS	
0090	0D5137	30161						WASHER; PE 4.5*10; PCS 10	
0091	033891	24109			A			RESISTOR	
0092	0KJ778	23395	0D7962		A			POWER BOARD; 3-PHASE	
0093	000000								
0094	0KL072	16418		S	A			COMMUTATOR 3 PHASE	
0095	0KQ662	11466		S	A			CONDENSER	
0096	0U0242	1127			D			HOLDER	
0097	000000								
0098	000000								
0099	0D0018	12152						TERMINAL BOARD	
0100	0D2848	24949						PRINTED CIRCUIT FIXING SPACER (SET X6)	
0S30	0KQ426	23541			A			FREQUENCY CONVERTER	