



heating elements

immersion heating elements

3 hole flange ø47.5mm



Part No.	415931	Ref. No.	5007076 5007076K
description	heating element 12000W 220V mounting ø 47.5mm heating circuits 3 L 585mm W 28mm H 28mm number of thermostat sleeves 1 thermostat sleeves ø 6.5mm length thermostat sleeves 170mm thermostat sleeve clinging tube ø 6.3mm hole distance 63mm hole ø 8mm cable length 950mm 3 hole flange immersion heater		
For models:	OD20.20, OS20.20, OSC20.20, OSP20.20		
accessories for	415931		
	Part No.	510408	Ref. No. 6005015
	O-ring EPDM thickness 5.34mm ID ø 47mm Qty 1 pcs		
	Part No.	510562	Ref. No. —
	O-ring silicone thickness 5.34mm ID ø 47mm Qty 1 pcs		

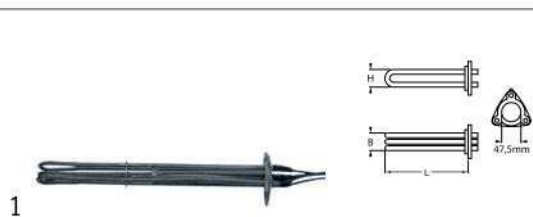

Part No.	415803	Ref. No.	5007062 5007062K
description	heating element 6000W 230V mounting ø 47.5mm heating circuits 3 L 325mm W 26mm H 38mm number of thermostat sleeves 1 thermostat sleeves ø 6mm length thermostat sleeves 160mm thermostat sleeve clinging tube ø 6.3mm hole distance 62mm hole ø 8mm cable length 790mm connection cable 3 hole flange immersion heater		
For models:	OD10.10, OD10.20, OS10.10, OS10.20, OSC10.10, OSC10.20, OSP10.10, OSP10.20		
spare parts for	415803		
	Part No.	510408	Ref. No. 6005015
	O-ring EPDM thickness 5.34mm ID ø 47mm Qty 1 pcs		
accessories for	415803		
	Part No.	510562	Ref. No. —
	O-ring silicone thickness 5.34mm ID ø 47mm Qty 1 pcs		

Зип Ощепит

vsezip.ru

+7(812)987-08-81

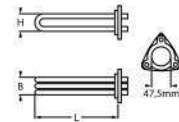

Part No.	415802	Ref. No.	5007071 5007071K 5030632
description	heating element 9000W 230V mounting ø 47.5mm heating circuits 3 L 385mm W 35mm H 46mm number of thermostat sleeves 1 thermostat sleeves ø 6mm length thermostat sleeves 160mm thermostat sleeve clinging tube ø 8.5mm hole distance 62mm hole ø 8mm cable length 800mm 3 hole flange immersion heater		
For models:	OD10.10, OD10.20, OD12.20, OD20.10, OD20.20, OD6.10, OS10.10, OS10.20, OS12.20, OS20.10, OS6.10, OSC10.10, OSC10.20, OSC12.20, OSC20.10, OSC6.10, OSP10.10, OSP10.20, OSP12.20, OSP20.10, OSP6.10		
accessories for	415802		
	Part No.	510562	Ref. No. —
	O-ring silicone thickness 5.34mm ID ø 47mm Qty 1 pcs		

miscellaneous



Part No.	420042	Ref. No.	2619180 5017003
description	heating element 13200W 230V heating circuits 3 L 545mm W 65mm H 33mm number of thermostat sleeves 1 thermostat sleeves ø 8mm length thermostat sleeves 160mm tube ø 8.5mm hole distance 71mm hole ø 7mm cable length 1000mm flange connection immersion heater flange width 57mm flange length 88mm		
For models:	OEB20.20, OES20.20		



Part No.	417733	Ref. No.	5056321
description	heating element 13300W 230V heating circuits 3 L 275mm W 35mm H 70mm number of thermostat sleeves 2 thermostat sleeves ø 3.5/8mm length thermostat sleeves 120/140mm thermostat sleeve eccentric, clinging tube ø 8.5mm hole distance 67mm hole ø 8mm combi-steamer flange width 82mm flange length 82mm with gasket and nut		





Part No.	420043	Ref. No.	2619178 5017001
description	heating element 6600W 230V heating circuits 3 L 275mm W 65mm H 37mm number of thermostat sleeves 1 thermostat sleeves ø 7.8mm length thermostat sleeves 150mm tube ø 8.5mm hole distance 71mm hole ø 7mm cable length 1050mm flange connection immersion heater flange width 57mm flange length 88mm		
For models:	OEB10.10, OEB10.20, OEB6.20, OES10.10, OES10.20, OES6.20		
accessories for	420043		
	Part No.	550992	Ref. No. 6015023
	gasket L 87mm W 57mm hole ø 6mm hole distance 70/40mm 4 holes thickness 3mm suitable for CONVOTHERM		



Зип Общепит

vsezip.ru







7(812)987-08-81



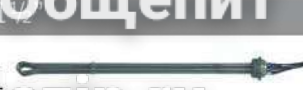



			
1			
Part No.	417601	Ref. No.	2619187 5017012
description	heating element 6600W 230V heating circuits 3 L 275mm W 70mm H 25mm hole distance 40x70mm hole ø 6.5mm cable length 1010mm tube ø 8.5mm flange length 87mm flange width 56mm thermostat sleeves ø 6mm number of thermostat sleeves 1 length thermostat sleeves 170mm		
For models:	OEB10.10, OEB10.20, OEB6.20, OES10.10, OES10.20, OES6.20		
accessories for	417601		
	Part No.	550992	Ref. No. 6015023
	gasket L 87mm W 57mm hole ø 6mm hole distance 70/40mm 4 holes thickness 3mm suitable for CONVOTHERM		

			
1			
Part No.	417734	Ref. No.	5056320
description	heating element 9000W 230V heating circuits 3 L 210mm W 40mm H 70mm number of thermostat sleeves 2 thermostat sleeves ø 3.5/8mm length thermostat sleeves 119/139mm thermostat sleeve eccentric, clinging tube ø 8.5mm hole distance 67mm hole ø 8mm flange combi-steamer flange width 82mm flange length 82mm		

			
1			
Part No.	417719	Ref. No.	2619188 5017013
description	heating element 9900W 230V heating circuits 3 L 415mm W 52mm H 37mm number of thermostat sleeves 1 thermostat sleeves ø 7.5mm length thermostat sleeves 160mm thermostat sleeve eccentric, clinging tube ø 8.5mm hole distance 71mm hole ø 7mm 4 hole flange immersion heater flange width 57mm flange length 88mm		
For models:	OEB10.10, OEB10.20, OEB12.20, OEB20.10, OEB20.20, OEB6.10, OEB6.20, OES10.10, OES10.20, OES12.20, OES20.10, OES6.10, OES6.20		
accessories for	417719		
	Part No.	550992	Ref. No. 6015023
	gasket L 87mm W 57mm hole ø 6mm hole distance 70/40mm 4 holes thickness 3mm suitable for CONVOTHERM		

			
1			
Part No.	418685	Ref. No.	2619179 5017002
description	heating element 9900W 230V heating circuits 3 L 415mm W 65mm H 37mm number of thermostat sleeves 1 thermostat sleeves ø 6.5mm length thermostat sleeves 160mm tube ø 8.5mm hole distance 72mm hole ø 7mm flange width 58mm flange length 88mm		
For models:	OEB10.10, OEB10.20, OEB12.20, OEB20.10, OEB6.10, OEB6.20, OES10.10, OES10.20, OES12.20, OES20.10, OES6.10, OES6.20		
accessories for	418685		
	Part No.	550992	Ref. No. 6015023
	gasket L 87mm W 57mm hole ø 6mm hole distance 70/40mm 4 holes thickness 3mm suitable for CONVOTHERM		

			
1			
Part No.	415874	Ref. No.	5007067 5007068 5007068K 5030631
description	heating element 12000/14300W 220/240V heating circuits 3 thread 1½" L 585mm W 40mm H 30mm thermostat sleeves ø 6.5mm length thermostat sleeves 160mm thermostat sleeve eccentric, clinging tube ø 6.3mm cable length 750mm connection cable immersion heater flange with thread hole distance 63mm mounting ø 47.5mm hole ø 8/10mm number of thermostat sleeves 1		
For models:	HUD20.20		
spare parts for	415874		
	Part No.	510406	Ref. No. 6005065
	flat gasket fibre ED ø 60mm ID ø 48mm thickness 3mm for thread 1½" Qty 1 pcs		
accessories for	415874		
	Part No.	510424	Ref. No. —
	gasket copper ED ø 55mm ID ø 48mm thickness 2.2mm Centellen for thread 1½"		
	Part No.	520211	Ref. No. —
	reducer thread 2" ET - 1½" IT brass		
	Part No.	520212	Ref. No. —
	hexagonal nut thread 1½" brass WS 60 H 8mm		
	Part No.	550361	Ref. No. —
	blind flange ø 58mm thread 1½"		







			
1			
Part No.	415500	Ref. No.	5007061 5007061K 5007063 5007063K 5030629
description	heating element 7500W 220V heating circuits 3 thread 1½" L 435mm W 33mm H 25mm tube ø 6.3mm cable length 780mm immersion heater flange with thread		
For models:	HUD10.10		
accessories for	415500		
	Part No.	510406	Ref. No. 6005065
	flat gasket fibre ED ø 60mm ID ø 48mm thickness 3mm for thread 1½" Qty 1 pcs		
	Part No.	510424	Ref. No. —
	gasket copper ED ø 55mm ID ø 48mm thickness 2.2mm Centellen for thread 1½"		
	Part No.	520211	Ref. No. —
	reducer thread 2" ET - 1½" IT brass		
	Part No.	520212	Ref. No. —
	hexagonal nut thread 1½" brass WS 60 H 8mm		
	Part No.	550361	Ref. No. —
	blind flange ø 58mm thread 1½"		



Зип Общежит

vsezip.ru

+7(812)987-08-81

			
1			
Part No.	415501	Ref. No.	5007066 5007066K 5030630
description	heating element 9000W 230V heating circuits 3 thread 1 1/2" L 450mm W 32mm H 26mm tube ø 6.3mm cable length 820mm connection cable immersion heater flange with thread		
For models:	HUD10.10, HUD12.20, HUD20.10, HUD6.10, OD10.10, OD10.20, OD12.20, OD20.10, OD20.20, OD6.10		
accessories for	415501		
	Part No.	510406	Ref. No. 6005065
	flat gasket fibre ED ø 60mm ID ø 48mm thickness 3mm for thread 1 1/2" Qty 1 pcs		
	Part No.	510424	Ref. No. —
	gasket copper ED ø 55mm ID ø 48mm thickness 2.2mm Centellen for thread 1 1/2"		
	Part No.	520211	Ref. No. —
	reducer thread 2" ET - 1 1/2" IT brass		
	Part No.	520212	Ref. No. —
	hexagonal nut thread 1 1/2" brass WS 60 H 8mm		
	Part No.	550361	Ref. No. —
	blind flange ø 58mm thread 1 1/2"		

heating elements for convection

			
1			
Part No.	420524	Ref. No.	2625104K 2630606
description	heating element 10200W 230V heating circuits 3 ID ø 250mm ED ø 320mm L 350mm H 58mm L1 70mm H1 8mm H2 58mm flange length 90mm flange width 70mm tube ø 8.5mm threaded		
spare parts for	420524		
	Part No.	521013	Ref. No. 2623226 6015025
	gasket set suitable for CONVOTHERM for heating element L 90mm W 71mm Qty 1m graphite hole distance 54/74mm		

			
1			
Part No.	420558	Ref. No.	5056330
description	heating element 10500W 230V heating circuits 3 ID ø 400mm ED ø 417mm L 472mm H 100mm H1 15mm H2 83mm flange length 90mm flange width 70mm hole distance 55mm connection M5 tube ø 8.5mm cable length 180mm convection heating element flange for combi-steamer series CONVOTHERM 4		

			
1			
Part No.	418684	Ref. No.	2619192 5017005
description	heating element 10500W 230V heating circuits 3 ID ø 402mm ED ø 420mm L 475mm H 100mm L1 55mm W1 29mm H1 25mm H2 75mm flange length 90mm flange width 70mm hole distance 74mm connection M5 tube ø 8.5mm convection heating element mounting thread M5 rectangular flange with bolt		
For models:	OEB6.10, OES6.10		

			
1			
Part No.	417718	Ref. No.	5007035 5007035K 5030625
description	heating element 12000W 220V heating circuits 3 ID ø 387mm ED ø 400mm L 430mm H 90mm H1 23mm H2 67mm thread M14 3 hole fixing connection male faston tube ø 6.5mm mounting pos. outer for combi-steamer		
For models:	AR100, AR108, AR28, AR30, AR40, AR50, AR54, HUD10.10, HUD20.10, OD6.10, OSC6.10, OSP10.10, OSP6.10, UG6.10		

			
1			
Part No.	415385	Ref. No.	5007036 5007036K 5030626
description	heating element 15000W 220V heating circuits 3 ID ø 390mm ED ø 405mm L 435mm H 110mm L1 22mm W1 300mm H1 22mm H2 84mm thread M14x1.5 6 hole fixing connection M5 tube ø 8.5mm convection heating element		
For models:	OD10.10, OD20.10, OS10.10, OS20.10, OSC10.10, OSC20.10, OSP10.10, OSP20.10		
accessories for	415385		
	Part No.	361182	Ref. No. —
	nut thread 1/4" H 5mm nickel-plated brass WS 17 Qty 1 pcs		
	Part No.	510417	Ref. No. —
	flat gasket fibre ED ø 20mm ID ø 14mm thickness 2mm Qty 1 pcs		
	Part No.	520228	Ref. No. —
	tooth lock washer ID ø 15.3mm ED ø 24mm steel Qty 1 pcs for thread M14		

Table continues overleaf



Зип Общепит

vsezip.ru

+7(812)987-08-81

accessories for	415385		
	Part No.	550262	Ref. No.
			—
	flat gasket copper ED ø 20mm ID ø 14mm thickness 2mm		

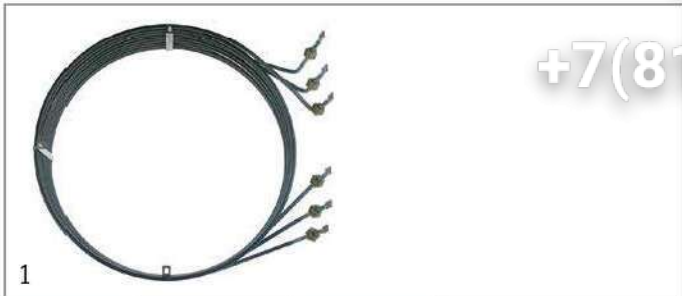

Part No.	418886	Ref. No.	5007038 5007038K 5007042K
description	heating element 18000W 380V heating circuits 3 ID ø 380mm ED ø 393mm L 435mm H 120mm L1 50mm H1 15mm thread M14x1.5 screw mounting tube ø 6.5mm convection heating element		
For models:	AR72, HUD10.10, HUD20.10, UG10.10, UG20.10		



Part No.	418768	Ref. No.	2619181 5017004
description	heating element 18900W 230V heating circuits 3 ID ø 467mm ED ø 484mm L 545mm H 99mm L1 6mm W1 28mm H1 14mm H2 85mm flange length 90mm flange width 70mm connection M4 connection length 112mm tube ø 8.5mm convection heating element with counterflange and cable		
For models:	OEB10.10, OEB20.10, OEB6.20, OES10.10, OES20.10, OES6.20		

Part No.	418768	spare parts for	
	Part No.	521013	Ref. No.
			2623226 6015025
	gasket set suitable for CONVOTHERM for heating element L 90mm W 71mm Qty 1m graphite hole distance 54/74mm		
	Part No.	692931	Ref. No.
			2623218
	connection set with fixing kit suitable for CONVOTHERM for heating element		



Part No.	418876	Ref. No.	2619190 5017016
description	heating element 18900W 230V heating circuits 3 ID ø 470mm ED ø 486mm L 540mm H 100mm L1 48mm H1 27mm H2 73mm flange length 90mm flange width 70mm hole distance 55mm connection M5 connection length 115mm tube ø 8.5mm convection heating element		
For models:	OEB10.10, OEB20.10, OEB6.20, OES10.10, OES20.10, OES6.20		



Part No.	420557	Ref. No.	5056331
description	heating element 18900W 230V heating circuits 3 ID ø 470mm ED ø 487mm L 540mm H 100mm H1 16mm H2 83mm flange length 90mm flange width 70mm hole distance 55mm connection M5 tube ø 8.5mm cable length 1300mm convection heating element flange connection for combi-steamer series CONVOTHERM 4		



Part No.	420559	Ref. No.	5056332
description	heating element 2x16500W 230V heating circuits 6 ID ø 485mm ED ø 570mm L 590mm H 134mm H1 22mm H2 108mm flange length 175mm flange width 105mm hole distance 80mm connection length M5mm tube ø 8.5mm cable length 1500mm convection heating element flange for combi-steamer series CONVOTHERM		



Part No.	419102	Ref. No.	2619177 5017000
description	heating element 33000W 230/400V heating circuits 6 ID ø 480mm ED ø 570mm L 590mm H 140mm flange length 175mm flange width 105mm		
For models:	OEB10.20, OEB12.20, OEB20.20, OES10.20, OES12.20, OES20.20		



Part No.	419233	Ref. No.	2618805
description	heating element 5400W 230V heating circuits 2 ID ø 252mm ED ø 269mm L 297mm H 62mm L1 11mm W1 65mm H1 12mm H2 50mm flange length 100mm flange width 22mm hole distance 87mm connection 6.3x0.8 tube ø 8.5mm for combi-steamer mounting thread M5 with mounting accessories OES6.06 Mini P3		
For models:	OES6.06		









Зип Общепит

vsezip.ru

+7(812)987-08-81

			
1			
Part No.	420156	Ref. No.	2123634 2625181 5017084
description	heating element 6800W 230V heating circuits 2 ID \varnothing 250mm ED \varnothing 265mm L 300mm H 65mm L1 38mm H1 7mm H2 56mm flange length 90mm flange width 70mm connection male faston 6.3mm connection length 77mm tube \varnothing 8.5mm convection heating element flange connection		
spare parts for	420156		
	Part No.	521013	Ref. No. 2623226 6015025
	gasket set suitable for CONVOTHERM for heating element L 90mm W 71mm Qty 1m graphite hole distance 54/74mm		

			
1			
Part No.	415384	Ref. No.	5007033 5007033K
description	heating element 9000W 230V heating circuits 3 ID \varnothing 390mm ED \varnothing 403mm L 440mm H 88mm L1 30mm W1 300mm H1 18mm H2 70mm thread M14x1.5 6 hole fixing connection M5 convection heating element		
For models:	AR28, AR40, OD10.10, OD10.20, OD6.10, OS6.10, OSC6.10, OSP6.10		
spare parts for	415384		
	Part No.	510417	Ref. No. —
	flat gasket fibre ED \varnothing 20mm ID \varnothing 14mm thickness 2mm Qty 1 pcs		
accessories for	415384		
	Part No.	520228	Ref. No. —
	tooth lock washer ID \varnothing 15.3mm ED \varnothing 24mm steel Qty 1 pcs for thread M14		
	Part No.	520230	Ref. No. —
	nut thread M14x1.5 H 5mm WS 19 zinc-coated steel Qty 1 pcs		
	Part No.	521101	Ref. No. —
	nut thread M14x1.5 H 5mm WS 19 SS Qty 1 pcs		
	Part No.	550262	Ref. No. —
	flat gasket copper ED \varnothing 20mm ID \varnothing 14mm thickness 2mm		

Part No.	420075	Ref. No.	5007022
description	mounting set suitable for convection heating element		
For models:	AR100, AR108, AR28, AR30, AR40, AR50, AR54, AR72, HUD10.10, HUD20.10, HUD6.10, OD10.10, OD20.10, OD6.10, OS10.10, OS6.10, OSC10.10, OSC6.10, OSP10.10, OSP6.10, UG10.10, UG20.10, UG6.10		

			
1			
Part No.	692737	Ref. No.	2623227 6015024
description	mounting set suitable for combi-steamer L 175mm W 105mm mounting pos. CONVOTHERM		
For models:	OEB10.20, OEB12.20, OEB20.20, OES10.20, OES12.20, OES20.20		

accessories

sealing washers

fibre gaskets

			
1			
Part No.	510416	Ref. No.	6005016
description	flat gasket fibre ED \varnothing 19mm ID \varnothing 10.5mm thickness 1.5mm for thread M10 Qty 1 pcs		
For models:	OD10.10, OD10.20, OD12.20, OD20.10, OD20.20, OD6.10, OEB10.10, OEB10.20, OEB12.20, OEB20.10, OEB20.20, OEB6.10, OEB6.20, OES10.10, OES10.20, OES12.20, OES20.10, OES20.20, OES6.10, OES6.20, OGB10.10, OGB10.20, OGB12.20, OGB20.10, OGB20.20, OGB6.10, OGB6.20, OGS10.10, OGS10.20, OGS12.20, OGS20.10, OGS20.20, OGS6.10, OGS6.20, OS10.10, OS10.20, OS12.20, OS20.10, OS20.20, OS6.10, OSP10.10, OSP10.20, OSP12.20, OSP20.10, OSP20.20, OSP6.10		

			
1			
Part No.	510406	Ref. No.	6005065
description	flat gasket fibre ED \varnothing 60mm ID \varnothing 48mm thickness 3mm for thread 1 1/2" Qty 1 pcs		
For models:	HUD10.10, HUD12.20, HUD20.10, HUD20.20, HUD6.10, OD10.10, OD10.20, OD12.20, OD20.10, OD20.20, OD6.10		



Зип Общепит control and safety thermostats

vsezip.ru

+7(812)987-08-81

O-rings

Part No.	510408	Ref. No.	6005015
description	O-ring EPDM thickness 5.34mm ID ø 47mm Qty 1 pcs		
For models:	OD10.10, OD10.20, OD12.20, OD20.10, OD20.20, OD6.10, OS10.10, OS10.20, OS12.20, OS20.10, OS20.20, OS6.10, OSC10.10, OSC10.20, OSC12.20, OSC20.10, OSC20.20, OSC6.10, OSP10.10, OSP10.20, OSP12.20, OSP20.10, OSP20.20, OSP6.10		

flange gaskets

Part No.	550992	Ref. No.	6015023
description	gasket L 87mm W 57mm hole ø 6mm hole distance 70/40mm 4 holes thickness 3mm suitable for CONVOTHERM		
For models:	OEB10.10, OEB10.20, OEB12.20, OEB20.10, OEB20.20, OEB6.10, OEB6.20, OES10.10, OES10.20, OES12.20, OES20.10, OES20.20, OES6.10, OES6.20, OGB10.10, OGB10.20, OGB12.20, OGB20.10, OGB20.20, OGB6.10, OGB6.20, OGS10.10, OGS10.20, OGS12.20, OGS20.10, OGS20.20, OGS6.10, OGS6.20		

thermostats

bi-metal thermostats

bi-metal thermostats

Part No.	391049	Ref. No.	5056372
description	bi-metal thermostat hole distance 24mm switch-off temp. 80°C 1NC 1-pole 10A 250V connection F6.3x0.8 suitable for CONVOTHERM		

EGO control and safety thermostats

55.10/19 series

Part No.	375631	Ref. No.	5001032
description	thermostat t.max. 249°C temperature range 55-249°C 1-pole 1NO 16A probe ø 3.1mm probe L 226mm capillary pipe 1270mm capillary pipe isolated 850mm gland nut 3/8"-M8x1 shaft ø ø6x4.6mm shaft L 23mm shaft position upper rotation 318°		
For models:	OD10.20, OD12.20		

Part No.	375632	Ref. No.	5001020
description	thermostat t.max. 90°C temperature range 30-90°C 1-pole 1CO 16A probe ø 6mm probe L 130mm capillary pipe 1300mm capillary pipe isolated 850mm gland nut M10x1 shaft ø ø6x4.6mm shaft L 23mm shaft position upper rotation 270°		
For models:	OD10.20, OD12.20		

55.13_ series

Part No.	375116	Ref. No.	5001021 5001021K 5001040
description	thermostat t.max. 258°C temperature range 58-258°C 1-pole 1NC 16A probe ø 3.1mm probe L 201mm capillary pipe 1130mm capillary pipe isolatedmm gland nut shaft ø ø6x4.6mm shaft L 23mm shaft position upper rotation 270°		
For models:	AR100, AR108, AR12, AR16, AR18, AR28, AR30, AR40, AR50, AR54, AR72, AR8, HUD10.10, HUD12.20, HUD20.10, HUD20.20, HUD6.10, UG10.10, UG10.20, UG20.10, UG20.20, UG4.05, UG6.05, UG6.10		



Зип Общепит

vsezip.ru

+7(812)987-08-81

safety thermostats

55.13_ series



1

Part No.	375245	Ref. No.	5019002 5019004
description	safety thermostat switch-off temp. 135°C 1-pole 16A probe \varnothing 6mm probe L 77mm capillary pipe 480mm capillary pipe isolatedmm gland nut probe SS		
For models:	OGB10.10, OGB10.20, OGB12.20, OGB20.10, OGB20.20, OGB6.10, OGB6.20, OGS10.10, OGS10.20, OGS12.20, OGS20.10, OGS20.20, OGS6.10, OGS6.20		



1

Part No.	375731	Ref. No.	5001026 5001026+6005081 5001026K
description	safety thermostat switch-off temp. 135°C 1-pole 1NC 16A probe \varnothing 6mm probe L 77mm capillary pipe 520mm capillary pipe isolatedmm gland nut probe SS		
For models:	OD10.10, OD10.20, OD12.20, OD20.10, OD20.20, OD6.10		



1

Part No.	375117	Ref. No.	5001030 5001030K 51021
description	safety thermostat switch-off temp. 325°C 1-pole 16A probe \varnothing 4mm probe L 91mm capillary pipe 390mm capillary pipe isolatedmm gland nut probe SS		
For models:	OD10.10, OD10.20, OD6.10		



1

Part No.	390126	Ref. No.	5001029 5001029K
description	safety thermostat switch-off temp. 340°C 1-pole 1NC 16A probe \varnothing 3.1mm probe L 201mm capillary pipe 1170mm capillary pipe isolatedmm gland nut probe SS		
For models:	AR108, AR72, OD10.10, OD10.20, OD12.20, OD20.10, OD20.20, OD6.10, OS10.10, OS10.20, OS12.20, OS20.10, OS20.20, OS6.10, OSC10.10, OSC10.20, OSC12.20, OSC20.10, OSC20.20, OSC6.10, OSP10.10, OSP10.20, OSP12.20, OSP20.10, OSP20.20, OSP6.10		

55.32_ series



1

Part No.	375392	Ref. No.	5001039
description	safety thermostat switch-off temp. 360°C 3-pole 1CO/2NC 20A probe \varnothing 4mm probe L 120mm capillary pipe 1490mm capillary pipe isolated 1450mm gland nut probe SS		
For models:	AR12, AR18, AR28, AR40, AR54, AR8, OES6.06		



1

Part No.	375017	Ref. No.	2618787
description	safety thermostat switch-off temp. 360°C 3-pole 20A probe \varnothing 4mm probe L 122mm capillary pipe 1490mm capillary pipe isolatedmm probe		
For models:	OES6.06		



Зип Общепит

vsezip.ru

+7(812)987-08-81



Part No.	375474	Ref. No.	5001031
description	safety thermostat t.max. 340°C switch-off temp. 340°C 2-pole 1NC/1CO 1x20/1x0.5A probe ø 4mm probe L 120mm capillary pipe 1300mm capillary pipe isolated 900mm gland nut probe		
For models:	OD10.10, OD10.20, OD12.20, OD20.20, OD6.10, OSG10.10, OSG12.20, OSG20.20		



Part No.	376061	Ref. No.	5056329
description	safety thermostat switch-off temp. 340°C 1-pole 16A probe ø 3mm probe L 160mm capillary pipe 1200mm capillary pipe isolated 1140mm		

56_ series



Part No.	381480	Ref. No.	5056319
description	safety thermostat switch-off temp. 170°C temperature range 14-170°C 1-pole 16A probe ø 6mm probe L 65mm capillary pipe 1460mm capillary pipe isolated 1400mm probe material SS 230V		



Part No.	375870	Ref. No.	5001041
description	safety thermostat switch-off temp. 340°C 1-pole 16A probe ø 3mm probe L 160mm capillary pipe 1150mm capillary pipe isolated 1080mm gland nut probe		
For models:	OEB10.10, OEB10.20, OEB12.20, OEB20.10, OEB20.20, OEB6.10, OEB6.20, OES10.10, OES10.20, OES12.20, OES20.10, OES20.20, OES6.10, OES6.20, OGB10.10, OGB10.20, OGB12.20, OGB20.10, OGB20.20, OGB6.10, OGB6.20, OGS10.10, OGS10.20, OGS12.20, OGS20.10, OGS20.20, OGS6.10, OGS6.20, OSC10.10, OSC10.20, OSC12.20, OSC20.10, OSC20.20, OSC6.10, OSG10.10, OSG12.20, OSG20.20, OSG6.10		

accessories

fitting parts



Part No.	550389	Ref. No.	4006041
description	bracket for contact thermostat		
For models:	HUD12.20, HUD20.20		



Part No.	550388	Ref. No.	4006031
description	bracket for contact thermostat mounting distance 24.5mm mounting ø 3.8		
For models:	HUD10.10, HUD20.10, HUD20.20, OD10.20, OD12.20		

gland nut accessories

ducts



Part No.	550148	Ref. No.	6005080
description	gland duct ET M12x0.75 IT M9x1 probe ø max. 6.5mm WS 17 silicone		
For models:	HUD10.10, HUD12.20, HUD20.10, HUD20.20, HUD6.10, OD10.10, OD10.20, OD12.20, OD20.10, OD20.20, OD6.10, OS12.20, OS20.10, OS20.20, OSC12.20, OSC20.10, OSC20.20, OSP12.20, OSP20.10, OSP20.20		

gaskets



Part No.	699830	Ref. No.	6015026
description	gasket silicone ø 10mm L 8mm		
For models:	OEB10.10, OEB10.20, OEB12.20, OEB20.10, OEB20.20, OEB6.10, OEB6.20, OES10.10, OES10.20, OES12.20, OES20.10, OES20.20, OES6.10, OES6.20, OGB10.10, OGB10.20, OGB12.20, OGB20.10, OGB20.20, OGB6.10, OGB6.20, OGS10.10, OGS10.20, OGS12.20, OGS20.10, OGS20.20, OGS6.10, OGS6.20		

1 electric components



switches and momentary switches

ЗипОбщепит

cam switches

on/off



1

Part No.	301282	Ref. No.	5003022
description	cam switch sequence 0-1 shaft \varnothing 6x4.6mm shaft L 19.5mm 4-pole rotation 45°		
For models:	OD10.10, OD10.20, OD12.20, OD20.10, OD20.20, OD6.10		

5 operating positions



1

Part No.	301277	Ref. No.	5003023
description	cam switch 5 operating positions 7NO sequence 0-1-2-3-4 16A shaft \varnothing 6x4.6mm shaft L 19mm connection male faston 6.3mm plastic		
For models:	OD10.10, OD10.20, OD12.20, OD20.10, OD20.20, OD6.10		

magnetic switches

28.5x19mm



1

Part No.	348210	Ref. No.	5056328
description	magnetic switch L 28.5mm W 19mm cable length 450mm PIC MS-328/980A 5214 suitable for CONVOTHERM		



1

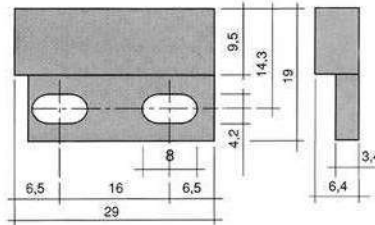

Part No.	345117	Ref. No.	5003075 5013070
description	magnetic switch L 28.5mm W 19mm 1NO 250V 0.04A P max. 10W connection cable cable length 1000mm		
For models:	OD10.10, OD10.20, OD12.20, OD20.10, OD20.20, OD6.10, OEB10.10, OEB10.20, OEB12.20, OEB20.10, OEB20.20, OEB6.10, OEB6.20, OES10.10, OES10.20, OES12.20, OES20.10, OES20.20, OES6.06, OES6.10, OES6.20, OGB10.10, OGB10.20, OGB12.20, OGB20.10, OGB20.20, OGB6.10, OGB6.20, OGS10.10, OGS10.20, OGS12.20, OGS20.10, OGS20.20, OGS6.10, OGS6.20, OS10.10, OS10.20, OS12.20, OS20.10, OS20.20, OS6.10, OSC10.10, OSC10.20, OSC12.20, OSC20.10, OSC20.20, OSC6.10, OSP10.10, OSP10.20, OSP12.20...(Other models you can see in the webshop)		



1

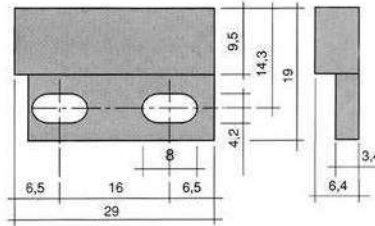

Part No.	345217	Ref. No.	5003082
description	magnetic switch L 29mm W 19mm 1NO 125V 0.5A P max. 10W connection cable cable length 2000mm		



Зип Общепит
control equipment

vsezip.ru
Lumotast series

+7(812)987-08-81



1

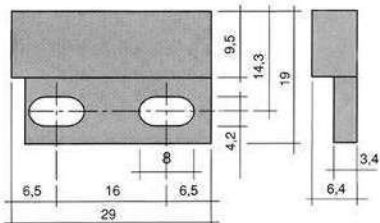

Part No.	347495	Ref. No.	2518798
description	magnetic switch L 29mm W 19mm 1NO 250V 0.3A P max. 10W connection cable cable length 2000mm PIC		
For models:	OES6.06		

M10x0.75

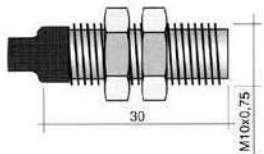

1

Part No.	345632	Ref. No.	5003079
description	magnetic switch thread M10x0.75 1NO 250V 0.5A P max. 50W connection cable cable length 2000mm type 102		
For models:	OD10.20, OD12.20, OD20.20, OSG10.10, OSG12.20, OSG20.20, OSG6.10		
accessories for	345632		
	Part No.	Ref. No.	—
	100779		
	nut thread M10x0.75 H 3mm WS 14 SS Qty 2 pcs		

accessories

magnets

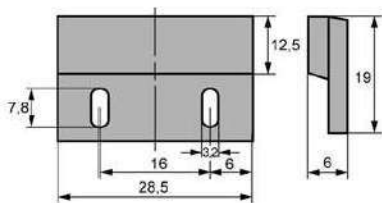

1

Part No.	345700	Ref. No.	5003076
description	magnet ømm L 29mm H 6.5mm W 19mm hole distance 16mm M3 hole ø 3.5mm		
For models:	OD10.10, OD10.20, OD12.20, OD20.10, OD20.20, OD6.10, OSP6.10		

RAFI Lumotast series

fascias



1

Part No.	345140	Ref. No.	5003054
description	bezel clear		
For models:	HUD10.10, HUD12.20, HUD20.10, HUD20.20, HUD6.10		

momentary push switches



1

Part No.	345139	Ref. No.	5003053
description	momentary push switch mounting measurements ø16mm 230V 1NC/1NO		
For models:	HUD10.10, HUD12.20, HUD20.10, HUD20.20, HUD6.10		

accessories for 345139

	Part No.	345140	Ref. No.	5003054
				bezel clear
	Part No.	346719	Ref. No.	—
				bezel yellow
	Part No.	346720	Ref. No.	—
				bezel rectangular green
	Part No.	346721	Ref. No.	—
				bezel rectangular red
	Part No.	359590	Ref. No.	—
				light bulb socket T5.5K 24V 3W ø 5.5mm L 22mm clear
	Part No.	359591	Ref. No.	—
				light bulb socket T5.5K 48V 3W ø 5.5mm L 22mm clear
	Part No.	359592	Ref. No.	—
				light bulb socket T5.5K 12V 3W ø 5.5mm L 22mm clear
	Part No.	359593	Ref. No.	—
				light bulb socket T5.5K 60V 0.02A



TELEMECANIQUE (EFA)

XB4 series

rotary switches



1

Part No.	347383	Ref. No.	5003031 5003031K 5003035
description	switch mounting measurements ø22mm 2NO 0-1 latching		
For models:	HUD10.10, HUD12.20, HUD20.10, HUD20.20, HUD6.10		

encoders and potentiometers



1

Part No.	300268	Ref. No.	5056359
description	encoder rotation 360° 0.01A shaft ø 6x5.5mm shaft L 17mm connection for ribbon cable for combi-steamer thread M10x0.75 5V CONVOTHERM 4 0.10hm CESI 32/LS EBE		



1

Part No.	300098	Ref. No.	5009095
description	potentiometer		
For models:	OD10.10, OD10.20, OD12.20, OD20.10, OD20.20, OD6.10		

lamps

indicator lights

indicator lights 3-piece (housing, lens and bulb)

lamps

light bulbs



1

Part No.	359055	Ref. No.	5003046
description	light bulb socket T1 1/2 12VW 0.08A ø 4.9mm L 13mm		
For models:	OD10.10, OD10.20, OD12.20, OD20.10, OD20.20, OD6.10		

Зип-Общепит

indicator lights (complete)

ø16mm

vsezip.ru

+7(812)987-08-81

Part No.	362003	Ref. No.	5004026
description	indicator light ø 16mm yellow connection F6.3 temp.-resist. 120°C		
For models:	AR100, AR108, AR12, AR16, AR18, AR28, AR30, AR40, AR50, AR54, AR72, AR8, UG10.10, UG10.20, UG20.10, UG20.20, UG4.05, UG6.05, UG6.10		

screw-on/push-on fit

light bulbs

for ovens



1

Part No.	359458	Ref. No.	2618779
description	light bulb socket E14 15W 230V with gasket		
For models:	OEB10.10, OEB10.20, OEB12.20, OEB20.10, OEB20.20, OEB6.10, OEB6.20, OES10.10, OES10.20, OES12.20, OES20.10, OES20.20, OES6.06, OES6.10, OES6.20, OGB10.10, OGB10.20, OGB12.20, OGB20.10, OGB20.20, OGB6.10, OGB6.20, OGS10.10, OGS10.20, OGS12.20, OGS20.10, OGS20.20, OGS6.10, OGS6.20		



1

Part No.	359610	Ref. No.	5005040 5005040K
description	light bulb t.max. 300°C socket E14 15W 230V ø 22mm L 47mm lens L 20mm for oven lamp type Philips		
For models:	HUD10.10, HUD12.20, HUD20.10, HUD20.20, HUD6.10, OD10.10, OD10.20, OD12.20, OD20.10, OD20.20, OD6.10, UG10.10, UG10.20, UG20.10, UG20.20, UG4.05, UG6.05, UG6.10		



1

Part No.	359612	Ref. No.	5005045
description	light bulb t.max. 300°C socket E14 25W 230V ø 25mm L 56mm lens L 30mm for oven lamp type Philips		

for indicator lights



1

Part No.	359055	Ref. No.	5003046
description	light bulb socket T1 1/2 12VW 0.08A ø 4.9mm L 13mm		
For models:	OD10.10, OD10.20, OD12.20, OD20.10, OD20.20, OD6.10		



oven lamps

universal oven lamps

mounting diameter 35.5mm



1

Part No.	359720	Ref. No.	5005012
description	oven lamp mounting ø 35.5mm 230V 15W socket E14 temp.-resist. 300°C connection male faston 6.3mm hard glas		
For models:	HUD10.10, HUD12.20, HUD20.10, HUD20.20, HUD6.10, OD10.10, OD10.20, OD12.20, OD20.10, OD20.20, OD6.10, UG10.10, UG10.20, UG20.10, UG20.20, UG4.05, UG6.05, UG6.10		
spare parts for	359720		
	Part No.	359701	Ref. No. 5005016
	lamp socket socket E14 220-230V mounting ø 35.5mm connection male faston 6.3mm 15W		
	Part No.	359705	Ref. No. 5005017 5005017K 5030620
	oven lamp glass thr.ø 33.5mm ø 52mm hard glas temp.-resist. 350°C		
	Part No.	359721	Ref. No. 5005025
	gasket silicone ED ø 48mm ID ø 39.5mm thickness 5mm Qty 1 pcs		
	Part No.	359740	Ref. No. —
	light bulb t.max. 300°C socket E14 15W 230V ø 22mm L 48mm lens L 20mm for oven lamp IMPORT		



1

Part No.	359701	Ref. No.	5005016
description	lamp socket socket E14 220-230V mounting ø 35.5mm connection male faston 6.3mm 15W		
For models:	OD10.10, OD10.20, OD12.20, OD20.10, OD20.20, OD6.10, OS10.10, OS10.20, OS12.20, OS20.10, OS20.20, OS6.10, OSC10.10, OSC10.20, OSC12.20, OSC20.10, OSC20.20, OSC6.10, OSG10.10, OSG12.20, OSG20.20, OSG6.10, OSP10.10, OSP10.20, OSP12.20, OSP20.10, OSP20.20, OSP6.10		
accessories for	359701		
	Part No.	359705	Ref. No. 5005017 5005017K 5030620
	oven lamp glass thr.ø 33.5mm ø 52mm hard glas temp.-resist. 350°C		
	Part No.	359709	Ref. No. —
	oven lamp glass thr.ø 33.5mm ø 42mm hard glas temp.-resist. 350°C		
	Part No.	359721	Ref. No. 5005025
	gasket silicone ED ø 48mm ID ø 39.5mm thickness 5mm Qty 1 pcs		
	Part No.	359942	Ref. No. —
	oven lamp glass thr.ø 33.5mm ø 41mm hard glas temp.-resist. 350°C		

Зип Общепит

vsezip.ru

+7(812)987-08-81

Part No.	359705	Ref. No.	5005017 5005017K 5030620
description	oven lamp glass thr.ø 33.5mm ø 52mm hard glas temp.-resist. 350°C		
For models:	HUD10.10, HUD12.20, HUD20.10, HUD20.20, HUD6.10, OD10.10, OD10.20, OD12.20, OD20.10, OD20.20, OD6.10, UG10.10, UG10.20, UG20.10, UG20.20, UG4.05, UG6.05, UG6.10		
accessories for	359705		
	Part No.	359610	Ref. No. 5005040 5005040K
	light bulb t.max. 300°C socket E14 15W 230V ø 22mm L 47mm lens L 20mm for oven lamp type Philips		
	Part No.	359700	Ref. No. —
	gasket for pizza oven fibre glass ID ø 32.5mm ED ø 55mm thickness 5mm		
	Part No.	359721	Ref. No. 5005025
	gasket silicone ED ø 48mm ID ø 39.5mm thickness 5mm Qty 1 pcs		
	Part No.	359837	Ref. No. —
	gasket ID ø 33mm ED ø 46mm thickness 1mm graphite		
	Part No.	359838	Ref. No. —
	gasket ID ø 33mm ED ø 45mm		





1

Part No.	359721	Ref. No.	5005025
description	gasket silicone ED ø 48mm ID ø 39.5mm thickness 5mm Qty 1 pcs		
For models:	HUD10.10, HUD12.20, HUD20.10, HUD20.20, HUD6.10, OD10.10, OD10.20, OD12.20, OD20.10, OD20.20, OD6.10, UG10.10, UG10.20, UG20.10, UG20.20, UG4.05, UG6.05, UG6.10		

55x70mm



1

Part No.	360730	Ref. No.	5056316
description	gasket		
accessories for	360730		
	Part No.	359596	Ref. No. 5056314
	halogen lamp socket G4 12V 10W temp.-resist. 500°C		
	Part No.	360728	Ref. No. 5056317
	lamp cover complete L 99.5mm W 84.5mm H 8.5mm mounting distance 68/83mm		
	Part No.	360729	Ref. No. 5056315
	lamp socket socket G4 with cable		

Зип-Общепит
products based oven lamps



CONVOTHERM

vsezip.ru

+7(812)987-08-81



1

Part No.	360728	Ref. No.	5056317
description	lamp cover complete L 99.5mm W 84.5mm H 8.5mm mounting distance 68/83mm		
accessories for	360728		
	Part No.	359596	Ref. No. 5056314
description	halogen lamp socket G4 12V 10W temp.-resist. 500°C		
	Part No.	360729	Ref. No. 5056315
description	lamp socket socket G4 with cable		
	Part No.	360730	Ref. No. 5056316
description	gasket		



1

Part No.	359297	Ref. No.	5015003 5015006
description	frame L 95mm W 81mm mounting distance 68/83mm thickness 6mm		
For models:	OEB10.10, OEB10.20, OEB12.20, OEB20.10, OEB20.20, OEB6.10, OEB6.20, OES10.10, OES10.20, OES12.20, OES20.10, OES20.20, OES6.06, OES6.10, OES6.20, OGB10.10, OGB10.20, OGB12.20, OGB20.10, OGB20.20, OGB6.10, OGB6.20, OGS10.10, OGS10.20, OGS12.20, OGS20.10, OGS20.20, OGS6.10, OGS6.20		
accessories for	359297		
	Part No.	359299	Ref. No. —
description	gasket L 91mm W 77mm hole ø 3mm for oven lamp		



1

Part No.	359296	Ref. No.	5015002
description	lamp glass L 74mm W 58mm thickness 3mm		
For models:	OEB10.10, OEB10.20, OEB12.20, OEB20.10, OEB20.20, OEB6.10, OEB6.20, OES10.10, OES10.20, OES12.20, OES20.10, OES20.20, OES6.06, OES6.10, OES6.20, OGB10.10, OGB10.20, OGB12.20, OGB20.10, OGB20.20, OGB6.10, OGB6.20, OGS10.10, OGS10.20, OGS12.20, OGS20.10, OGS20.20, OGS6.10, OGS6.20		

products based oven lamps

CONVOTHERM

vsezip.ru

+7(812)987-08-81

1

Part No.	360641	Ref. No.	6015018 6015020 N/A
description	gasket L 86mm W 71mm PTFE thickness 0.5mm for oven lamp		
For models:	OEB10.10, OEB10.20, OEB12.20, OEB20.10, OEB20.20, OEB6.10, OEB6.20, OES10.10, OES10.20, OES12.20, OES20.10, OES20.20, OES6.06, OES6.10, OES6.20, OGB10.10, OGB10.20, OGB12.20, OGB20.10, OGB20.20, OGB6.10, OGB6.20, OGS10.10, OGS10.20, OGS12.20, OGS20.10, OGS20.20, OGS6.10, OGS6.20		





1

Part No.	358180	Ref. No.	6015018 6015020
description	gasket L 94mm W 78mm PTFE thickness 3mm for oven lamp		



1

Part No.	360728	Ref. No.	5056317
description	lamp cover complete L 99.5mm W 84.5mm H 8.5mm mounting distance 68/83mm		
accessories for	360728		
	Part No.	359596	Ref. No. 5056314
description	halogen lamp socket G4 12V 10W temp.-resist. 500°C		
	Part No.	360729	Ref. No. 5056315
description	lamp socket socket G4 with cable		
	Part No.	360730	Ref. No. 5056316
description	gasket		



1

Part No.	694335	Ref. No.	5015005
description	lamp glass L 87mm W 72mm thickness 3mm		



Зип Общепит

vsezip.ru

+7(812)987-08-81

1 

Part No.	359488	Ref. No.	261878
description	oven lamp complete mounting measurements 55x70mm 230V 15W socket E14 rectangular connection male faston 6.3mm L 87mm W 70mm		
For models:	OEB10.10, OEB10.20, OEB12.20, OEB20.10, OEB20.20, OEB6.10, OEB6.20, OES10.10, OES10.20, OES12.20, OES20.10, OES20.20, OES6.06, OES6.10, OES6.20, OGB10.10, OGB10.20, OGB12.20, OGB20.10, OGB20.20, OGB6.10, OGB6.20, OGS10.10, OGS10.20, OGS12.20, OGS20.10, OGS20.20, OGS6.10, OGS6.20		
spare parts for	359488		
	Part No.	358180	Ref. No. 6015018 6015020
	gasket L 94mm W 78mm PTFE thickness 3mm for oven lamp		
	Part No.	359297	Ref. No. 5015003 5015006
	frame L 95mm W 81mm mounting distance 68/83mm thickness 6mm		
	Part No.	359299	Ref. No. —
	gasket L 91mm W 77mm hole ø 3mm for oven lamp		
	Part No.	694335	Ref. No. 5015005
	lamp glass L 87mm W 72mm thickness 3mm		

1 

Part No.	359701	Ref. No.	5005016
description	lamp socket socket E14 220-230V mounting ø 35.5mm connection male faston 6.3mm 15W		
For models:	OD10.10, OD10.20, OD12.20, OD20.10, OD20.20, OD6.10, OS10.10, OS10.20, OS12.20, OS20.10, OS20.20, OS6.10, OSC10.10, OSC10.20, OSC12.20, OSC20.10, OSC20.20, OSC6.10, OSG10.10, OSG12.20, OSG20.20, OSG6.10, OSP10.10, OSP10.20, OSP12.20, OSP20.10, OSP20.20, OSP6.10		
accessories for	359701		
	Part No.	359705	Ref. No. 5005017 5005017K 5030620
	oven lamp glass thr.ø 33.5mm ø 52mm hard glas temp.-resist. 350°C		
	Part No.	359709	Ref. No. —
	oven lamp glass thr.ø 33.5mm ø 42mm hard glas temp.-resist. 350°C		
	Part No.	359721	Ref. No. 5005025
	gasket silicone ED ø 48mm ID ø 39.5mm thickness 5mm Qty 1 pcs		
	Part No.	359942	Ref. No. —
	oven lamp glass thr.ø 33.5mm ø 41mm hard glas temp.-resist. 350°C		

1 

Part No.	692171	Ref. No.	5005020
description	frame for lamp lenses bore ø 6.3mm D1 ø 72mm D2 ø 56mm L 83mm W 83mm thickness 1mm		
For models:	OD10.10, OD10.20, OD12.20, OD20.10, OD20.20, OD6.10, OS10.10, OS10.20, OS12.20, OS20.10, OS20.20, OS6.10, OSC10.10, OSC10.20, OSC12.20, OSC20.10, OSC20.20, OSC6.10, OSP10.10, OSP10.20, OSP12.20, OSP20.10, OSP20.20, OSP6.10		

1 

Part No.	360629	Ref. No.	2628501
description	oven lamp incl. gasket mounting ø 10mm 12V 10W socket G4 CONVOTHERM temp.-resist. 300°C		
spare parts for	360629		
	Part No.	359596	Ref. No. 5056314
	halogen lamp socket G4 12V 10W temp.-resist. 500°C		

1 

Part No.	359643	Ref. No.	5005022
description	lamp glass ø 69mm thickness 4mm		
For models:	OD10.10, OD10.20, OD12.20, OD20.10, OD20.20, OD6.10, OS10.10, OS10.20, OS12.20, OS20.10, OS20.20, OS6.10, OSC10.10, OSC10.20, OSC12.20, OSC20.10, OSC20.20, OSC6.10, OSP10.10, OSP10.20, OSP12.20, OSP20.10, OSP20.20, OSP6.10		

1 

Part No.	360680	Ref. No.	2628500
description	oven lamp incl. gasket mounting ø 10mm 12V 10W socket G4 CONVOTHERM temp.-resist. 300°C		
spare parts for	360680		
	Part No.	359596	Ref. No. 5056314
	halogen lamp socket G4 12V 10W temp.-resist. 500°C		



Зип.Общепит

timers

vsezip.ru

+7(812)987-08-81

lamps

light bulbs

PHILIPS



1

Part No.	359610	Ref. No.	5005040 5005040K
description	light bulb t.max. 300°C socket E14 15W 230V ø 22mm L 47mm lens L 20mm for oven lamp type Philips		
For models:	HUD10.10, HUD12.20, HUD20.10, HUD20.20, HUD6.10, OD10.10, OD10.20, OD12.20, OD20.10, OD20.20, OD6.10, UG10.10, UG10.20, UG20.10, UG20.20, UG4.05, UG6.05, UG6.10		

PHILIPS



1





Part No.	359612	Ref. No.	5005045
description	light bulb t.max. 300°C socket E14 25W 230V ø 25mm L 56mm lens L 30mm for oven lamp type Philips		

sockets

G4 / G5,3 / G6,35



1

Part No.	360729	Ref. No.	5056315
description	lamp socket socket G4 with cable		
accessories for	360729		
	Part No.	Ref. No.	5056314
	halogen lamp socket G4 12V 10W temp.-resist. 500°C		
	Part No.	Ref. No.	5056317
lamp cover complete L 99.5mm W 84.5mm H 8.5mm mounting distance 68/83mm			
	Part No.	Ref. No.	5056316
gasket			

mechanical timers



1

Part No.	350023	Ref. No.	5001003 5001003K
description	timer M2 2-pole operation time 90min impulse mechanical 2CO at 250V 16A permanent position no shaft ø 6x4.6mm shaft 6x4.6mm shaft L 23mm mounting distance 28mm connection lateral		
For models:	HUD10.10, HUD12.20, HUD20.10, HUD20.20, HUD6.10, UG10.10, UG10.20, UG20.10, UG20.20, UG4.05, UG6.05, UG6.10		
accessories for	350023		
	Part No.	Ref. No.	110366 —
knob switch zero mark t.max.°C ø 44mm shaft ø 6x4.6mm shaft flat upper black			



1

Part No.	350112	Ref. No.	5001001 5001001K
description	timer M2 2-pole operation time 90min impulse mechanical 2NO at 250V 16A permanent position no shaft ø 6x4.6mm shaft 6x4.6mm shaft L 23mm mounting distance 28mm connection rear		
For models:	AR100, AR108, AR12, AR16, AR18, AR28, AR30, AR40, AR50, AR54, AR72, AR8, UG10.10, UG10.20, UG20.10, UG20.20, UG4.05, UG6.05, UG6.10		

alarm devices

buzzers



1

Part No.	350053	Ref. No.	4003050
description	buzzer 12VAC connection male faston 3.2mm screw mounting buzzer		
For models:	HUD10.10, HUD12.20, HUD20.10, HUD20.20, HUD6.10, OD10.10, OD10.20, OD12.20, OD20.10, OD20.20, OD6.10, UG10.10, UG10.20, UG20.10, UG20.20, UG4.05, UG6.05, UG6.10		



Зип Общепит

auxiliary contacts

vsezip.ru

77(812)987-08-81



1

Part No.	350050	Ref. No.	5003050
description	buzzer 230VAC connection male faston 6.3mm screw mounting thread M4 60dB		

contactors

BENEDIKT & JÄGER

power contactors



1

Part No.	381476	Ref. No.	5056963
description	power contactor resistive load 130A 230 (AC3/400V) 37kW main contacts 3NO connection screw type K3-74A00		



1

Part No.	380774	Ref. No.	5056373A
description	power contactor resistive load 32A 230VAC (AC3/400V) 18A/7.5kW main contacts 3NO auxiliary contacts 1NO connection screw connection type K3-18ND10		



1

Part No.	380775	Ref. No.	5056962
description	power contactor resistive load 65A 230VAC (AC3/400V) 32A/15kW main contacts 3NO auxiliary contacts connection screw connection type K3-32A00230		



1

Part No.	381456	Ref. No.	5056966
description	auxiliary contact contacts 1NC/1NO AC15 3A connection screw type HKA11		



1

Part No.	380678	Ref. No.	5056965
description	auxiliary contact contacts 1NO AC15 10A for contactors K2/K3 connection screw type HN10 AC1 25A		

GENERAL ELECTRIC (AEG)

power contactors



1

Part No.	380247	Ref. No.	4001020 4001020K 4001027 4011000
description	power contactor resistive load 25A 400VAC (AC3/400V) 9A/4kW main contacts 3NO auxiliary contacts 1NC connection screw connection type AEG LS4K 01A type GE CL00A 301		
For models:	AR108, AR28, HUD10.10, OD10.10, OD10.20, OD12.20, OD20.10, OD20.20, OD6.10, OEB10.10, OEB10.20, OEB12.20, OEB20.10, OEB20.20, OEB6.10, OEB6.20, OES10.10, OES10.20, OES12.20, OES20.10, OES20.20, OES6.06, OES6.10, OES6.20, OGB10.10, OGB10.20, OGB12.20, OGB20.10, OGB20.20, OGB6.10, OGB6.20, OGS10.10, OGS10.20, OGS12.20, OGS20.10, OGS20.20, OGS6.10, OGS6.20, OSC10.10, OSC10.20, OSC12.20, OSC20.10, OSC20.20, OSC6.10, OSG10.10, OSG12.20, OSG20.20, OSG6.10, OSP10.10, OSP10.20...(Other models you can see in the webshop)		



Зип Общепит

vsezip.ru

+7(812)987-08-81

1

Part No.	381342	Ref. No.	4011001 4011001K 4030609
description	power contactor resistive load 25A 230VAC (AC3/400V) 18A/7.5kW main contacts 3NO auxiliary contacts 1NO/1NC connection elastic terminals type LC1D183P7		
For models:	OEB10.10, OEB10.20, OEB12.20, OEB20.10, OEB20.20, OEB6.10, OEB6.20, OES10.10, OES10.20, OES12.20, OES20.10, OES20.20, OES6.10, OES6.20		

1

Part No.	380265	Ref. No.	4001041 4011013K
description	power contactor resistive load 60A 230VAC (AC3/400V) 32A/16kW main contacts 3NO auxiliary contacts 1NO connection screw connection type AEG LS15K 00A type GE CL04A 310 H 98mm L 87mm W 55mm		
For models:	AR108, OD10.10, OD10.20, OD12.20, OD20.10, OD20.20, OD6.10, OSC10.10, OSC10.20, OSC12.20, OSC20.10, OSC20.20, OSP10.10, OSP10.20, OSP12.20, OSP20.10, OSP20.20, OSP6.10		

auxiliary contacts



1

Part No.	380269	Ref. No.	4001072
description	auxiliary contact contacts 1NC AC15 6A for contactors CL+LS_K connection screw AC-12 10A type AEG HS07K 01 type GE BCLF 01		
For models:	HUD10.10, OD10.10, OD10.20, OD12.20, OD20.10, OD20.20, OD6.10		



1

Part No.	380268	Ref. No.	4001070
description	auxiliary contact contacts 1NO for contactors CL+LS_K connection screw AC-12 10A type AEG HS07K 10 type GE BCLF 10		
For models:	HUD20.20		



1

Part No.	380952	Ref. No.	4001015 4001030 4001030K 4030607
description	power contactor resistive load 40A 230VAC (AC3/400V) 25A/11kW main contacts 4NO auxiliary contacts 1NO/1NC connection screw connection type LC1DT40P7		
For models:	AR100, AR108, AR12, AR16, AR18, AR28, AR30, AR40, AR50, AR54, AR72, HUD10.10, HUD12.20, HUD20.10, HUD20.20, HUD6.10, OD10.10, OD10.20, OD12.20, OD20.10, OD20.20, OD6.10, OSC10.10, OSC10.20, OSC12.20, OSC20.10, OSC20.20, OSC6.10, OSP10.10, OSP10.20, OSP12.20, OSP20.10, OSP20.20, OSP6.10, UG10.10, UG20.10, UG6.05		

TELEMECANIQUE (Schneider Electric)

power contactors



1

Part No.	381204	Ref. No.	4011000K
description	power contactor resistive load 20A 230VAC (AC3/400V) 9A/4kW main contacts 3NO auxiliary contacts 1NO/1NC connection spring terminal type LC1D093P7 with RC circuit LAD4RCU		

ABL SURSUM

motor protection circuit breakers



1

Part No.	380300	Ref. No.	4002034
description	motor protection circuit breaker type Mbs25-016 setting range 1-1.6A (AC3/400V) 0.55kW		
For models:	HUD10.10, HUD20.10, HUD6.10, OD10.10, OD10.20, OD12.20, OD6.10, UG10.20, UG20.20		
accessories for	380300		



Part No.	380305	Ref. No.	4002039
-----------------	--------	-----------------	---------

auxiliary contact contacts 1NO/1NC HMS11



Зип Общепит

accessories

vsezip.ru

+7(812)987-08-81



1

Part No.	380301	Ref. No.	4002035
description	motor protection circuit breaker type Mbs25-025 setting range 1.6-2.5A (AC3/400V) 1.1kW		
For models:	AR18, AR28, AR40, AR54, OD10.10, OD10.20, OD12.20, OD20.10, OD20.20, OD6.10, OSG10.10, OSG12.20, OSG20.20, OSG6.10		



1

Part No.	380302	Ref. No.	4002036
description	motor protection circuit breaker type Mbs25-040 setting range 2.5-4A (AC3/400V) 1.5kW		
For models:	OD10.10, OD10.20, OD12.20, OD20.20, OD6.10, OSG10.10, OSG12.20, OSG20.20, OSG6.10		



1

Part No.	380322	Ref. No.	4002032
description	motor protection circuit breaker type SFK0E setting range 0.63-1A (AC3/400V) 0.5kW GENERAL ELECTRIC		
For models:	AR108, AR28, AR40, AR54, AR72, HUD10.10, HUD12.20, HUD20.10, HUD20.20, HUD6.10, OD10.10, OD10.20, OD12.20, OD20.10, OD20.20, OD6.10, UG10.10, UG20.10, UG6.10		



1

Part No.	380305	Ref. No.	4002039
description	auxiliary contact contacts 1NO/1NC HMS11		
For models:	HUD12.20, HUD20.20, OD10.10, OD10.20, OD12.20, OD20.10, OD20.20, OD6.10		

solid state relays

CRYDOM



1

Part No.	403868	Ref. No.	5056381
description	solid state relay CRYDOM 1 phase 90A 480V 4-32VDC L 58mm W 4mm screw type CWD4890P		

relays

power relays

with flange mounting



1

Part No.	380131	Ref. No.	4000017
description	power relays Italiana Relè 230VAC 16A 3CO connection male faston 6.3mm screw mounting manuf. no. B2-3-230AC		



Зип Общепит

with male contacts

female contact 2.0mm

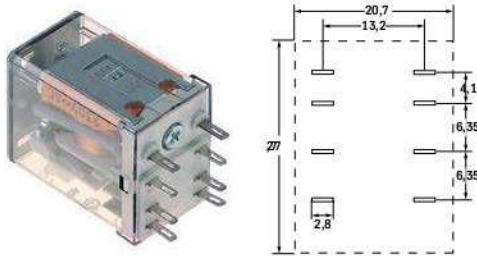

1

Part No.	380377	Ref. No.	4000022
description	power relays FINDER 220-240VAC 10A 2CO connection F2 plug-in connection manuf. no. 55.32.8.230.0000 94.92.3 250V		
For models:	OD10.20, OD12.20		
accessories for	380377		
	Part No.	380341	Ref. No. —
	relay socket 4-pole contacts 12 300V voltage AC 6A Italiana Relè manuf. no. ZMD4		
	Part No.	380378	Ref. No. —
	relay socket 2-pole 55/85 dimensions 70.5x30x27mm 250V voltage AC 10A FINDER manuf. no. 94.72		
	Part No.	380384	Ref. No. —
	relay socket 2-pole contacts male faston 2.8mm 250V voltage AC 10A W 23mm for		
	Part No.	380399	Ref. No. —
	relay socket 4-pole dimensions 76.2x27x86.1mm 250V voltage AC 1A FINDER manuf. no. 94.94.3		

plug-in/print relays



1

Part No.	381090	Ref. No.	4000012
description	print relay 12VDC at 250V 10A with relay socket		
spare parts for	381090		
	Part No.	380500	Ref. No. —
	print relay 12VDC 2CO at 250V 8A connection pins raster size 5mm REIPOL		

vsezip.ru

+7(812)987-08-81



1

Part No.	381091	Ref. No.	4000013
description	print relay 230V voltage AC at 250V 10A with relay socket		
For models:	OD10.10, OD12.20, OD20.20, OD6.10, OSG10.10, OSG12.20, OSG20.20, OSG6.10		

transformers

power supplies



1

Part No.	402981	Ref. No.	2618809 5056385
description	power supply primary 100-240VAC secondary 12VDC 60VA secondary 5A H.38mm L.99mm W.155mm connection screw 50/60Hz type ABL1REM12050 combi-steamer P3-devices		
For models:	OES6.06		

probes

producer-specific probes

probes



1

Part No.	400024	Ref. No.	5009050
description	temperature probe NTC 100kOhm cable PVC probe -40 up to +125°C cable -10 up to 100°C connection plug thread M10 probe ø6x120mm cable length 0.1m		
For models:	HUD10.10, HUD12.20, HUD20.10, HUD20.20, HUD6.10		



1

Part No.	379409	Ref. No.	5001035
description	temperature probe Pt100 cable PVC probe -100 up to 450°C cable -10 up to 100°C connection 2-wire thread M10 probe ø3x60mm cable length 0.7m		
For models:	OD10.10, OD10.20, OD12.20, OD20.20, OD6.10		



1



Part No.	379726	Ref. No.	5009053
description	temperature probe Pt100 cable silicone probe -100 up to 450°C cable -50 up to +180°C connection 3-wire thread M10x1 probe ø3x130mm cable length 1.5m		
For models:	OD10.10, OD10.20, OD12.20, OD20.20, OD6.10		





Зип Общепит

vsezip.ru



+7(812)987-08-81

			
Part No.	379104	Ref. No.	5009052
description	temperature probe Pt100 cable silicone probe -50 up to +300°C cable -50 up to +200°C connection 2-wire thread M10 probe ø4.5x-20mm cable length 3m		
For models:	OD10.10, OD10.20, OD12.20, OD20.10, OD20.20, OD6.10, OSP10.20, OSP12.20		
accessories for	379104		
	Part No.	510416	Ref. No. 6005016
flat gasket fibre ED ø 19mm ID ø 10.5mm thickness 1.5mm for thread M10 Qty 1 pcs			

			
Part No.	379105	Ref. No.	5001022 5001023
description	temperature probe Pt100 cable silicone probe -50 up to +600°C cable -50 up to +180°C connection 2-wire thread M14x1.5 probe ø3x350mm cable length 2.4m		
For models:	OD10.10, OD10.20, OD12.20, OD20.10, OD20.20, OD6.10		

			
Part No.	379410	Ref. No.	5001015
description	temperature probe thermocouple K (NiCr-Ni) cable silicone probe -50 up to 1150°C cable -50 up to +180°C connection 2-wire thread M10 probe ø3x125mm cable length 1.5m		
For models:	OSG10.10, OSG12.20, OSG20.20, OSG6.10		

			
Part No.	379420	Ref. No.	5001016
description	temperature probe thermocouple K (NiCr-Ni) cable silicone probe -50 up to 1150°C cable -50 up to +180°C connection 2-wire thread M10 probe ø3x70mm cable length 0.7m		
For models:	OSG10.10, OSG12.20, OSG20.20, OSG6.10		

			
Part No.	379800	Ref. No.	5002100 5002100K 5002101 5016014K 5030618
description	temperature probe thermocouple K (NiCr-Ni) cable silicone probe -50 up to 1150°C cable -50 up to +180°C connection 2-wire thread M5 probe ø4x20mm cable length 3m		
For models:	OEB10.10, OEB10.20, OEB12.20, OEB20.10, OEB20.20, OEB6.10, OEB6.20, OES10.10, OES10.20, OES12.20, OES20.10, OES20.20, OES6.06, OES6.10, OES6.20, OGB10.10, OGB10.20, OGB12.20, OGB20.10, OGB20.20, OGB6.10, OGB6.20, OGS10.10, OGS10.20, OGS12.20, OGS20.10, OGS20.20, OGS6.10, OGS6.20, OS10.10, OS10.20, OS12.20, OS20.10, OS20.20, OS6.10, OSC10.10, OSC10.20, OSC12.20, OSC20.10, OSC20.20, OSC6.10, OSG20.20, OSP10.10, OSP10.20, OSP12.20, OSP20.10, OSP20.20, OSP6.10		
accessories for	379800		
	Part No.	521012	Ref. No. 6005260
gasket graphite ED ø 15mm ID ø 5mm thickness 1.2mm Qty 1 pcs			

			
Part No.	402164	Ref. No.	5002102 5002102K 5030619
description	temperature probe thermocouple K (NiCr-Ni) cable silicone probe -50 up to 1150°C cable -50 up to +180°C connection 2-wire thread M8 probe ø3x130/230mm cable length 2.1m		
For models:	OS10.10, OS10.20, OS12.20, OS20.10, OS20.20, OS6.10, OSC10.10, OSC10.20, OSC12.20, OSC20.10, OSC20.20, OSC6.10, OSP10.10, OSP10.20, OSP12.20, OSP20.10, OSP20.20, OSP6.10		

			
Part No.	379536	Ref. No.	5016003
description	temperature probe thermocouple K (NiCr-Ni) cable silicone probe -50 up to 1150°C cable -50 up to +180°C connection 2-wire thread probe ø1.5x230mm cable length 2m		
For models:	OEB20.20, OGB10.10, OGB10.20, OGB12.20, OGB20.10, OGB20.20, OGB6.10, OGB6.20, OGS10.10, OGS10.20, OGS12.20, OGS20.10, OGS20.20, OGS6.10, OGS6.20		

			
Part No.	379440	Ref. No.	5002103 5016017
description	temperature probe thermocouple K (NiCr-Ni) cable silicone probe -50 up to 1150°C cable -50 up to +180°C connection 2-wire thread probe ø1.5x35mm cable length 1.6m		
For models:	OS10.20, OS6.10, OSC10.10, OSC10.20, OSC12.20, OSC20.10, OSC20.20, OSC6.10, OSP10.10, OSP10.20, OSP12.20, OSP20.10, OSP20.20, OSP6.10		

			
Part No.	379751	Ref. No.	5002104
description	temperature probe thermocouple K (NiCr-Ni) cable silicone probe -50 up to 1150°C cable -50 up to +180°C connection 2-wire thread probe ø1.5x35mm cable length 2.8m		
For models:	OEB10.10, OEB10.20, OEB12.20, OEB20.10, OEB20.20, OEB6.10, OEB6.20, OES10.10, OES10.20, OES12.20, OES20.10, OES20.20, OES6.10, OES6.20, OGB10.10, OGB10.20, OGB12.20, OGB20.10, OGB20.20, OGB6.10, OGB6.20, OS10.10, OS12.20, OS20.10, OS20.20, OSC10.10, OSC12.20, OSC20.10, OSC20.20, OSP10.10, OSP12.20, OSP20.10, OSP20.20		

			
Part No.	379751	Ref. No.	5002104
description	temperature probe thermocouple K (NiCr-Ni) cable silicone probe -50 up to 1150°C cable -50 up to +180°C connection 2-wire thread probe ø1.5x35mm cable length 2.8m		
For models:	OEB10.10, OEB10.20, OEB12.20, OEB20.10, OEB20.20, OEB6.10, OEB6.20, OES10.10, OES10.20, OES12.20, OES20.10, OES20.20, OES6.10, OES6.20, OGB10.10, OGB10.20, OGB12.20, OGB20.10, OGB20.20, OGB6.10, OGB6.20, OS10.10, OS12.20, OS20.10, OS20.20, OSC10.10, OSC12.20, OSC20.10, OSC20.20, OSP10.10, OSP12.20, OSP20.10, OSP20.20		