

Зип Общепит

vsezip.ru

+7(812)987-08-81



**SC6**

**Edition 20030301-**

FINO AL '08-2  
UNTIL '08-20

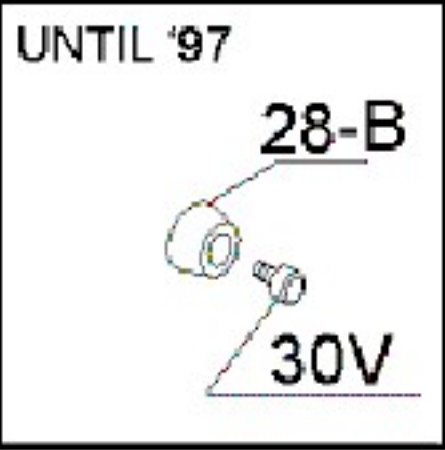

Зип Общепит

vsezip.ru

54  
+7(812)987-08-81

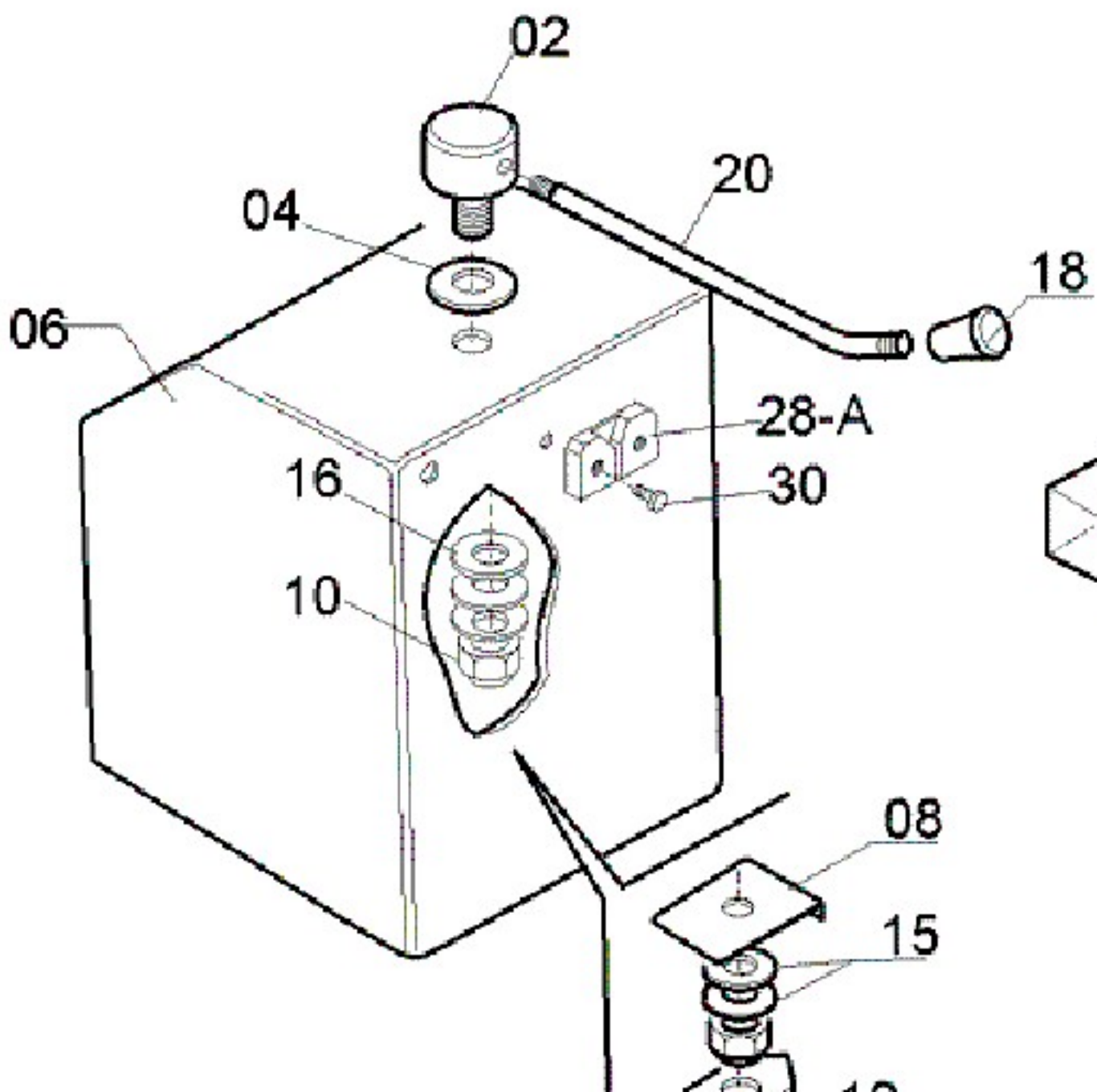

Зип Общепит

vsezip.ru

+7(812)987-08-81

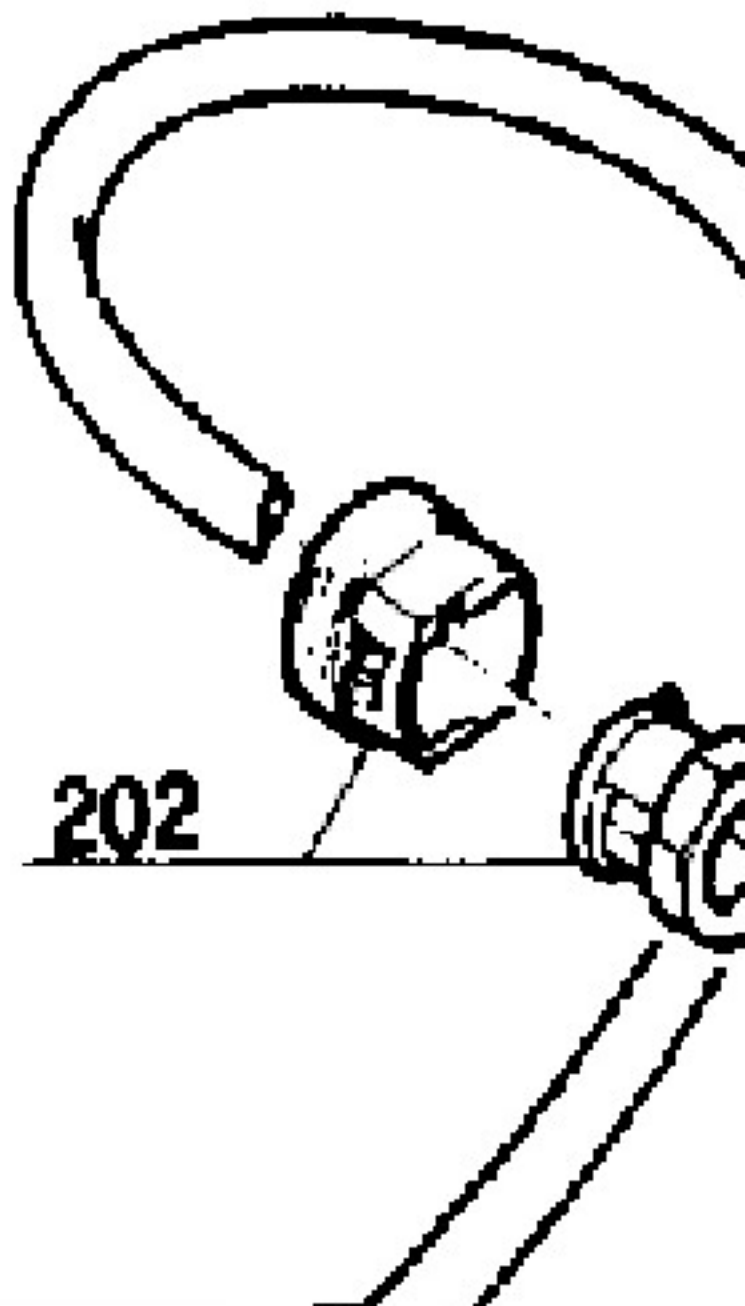

202

SIMO LINE 200-A

Зип Общепит

[vsezip.ru](http://vsezip.ru)

+7(812)987-08-81

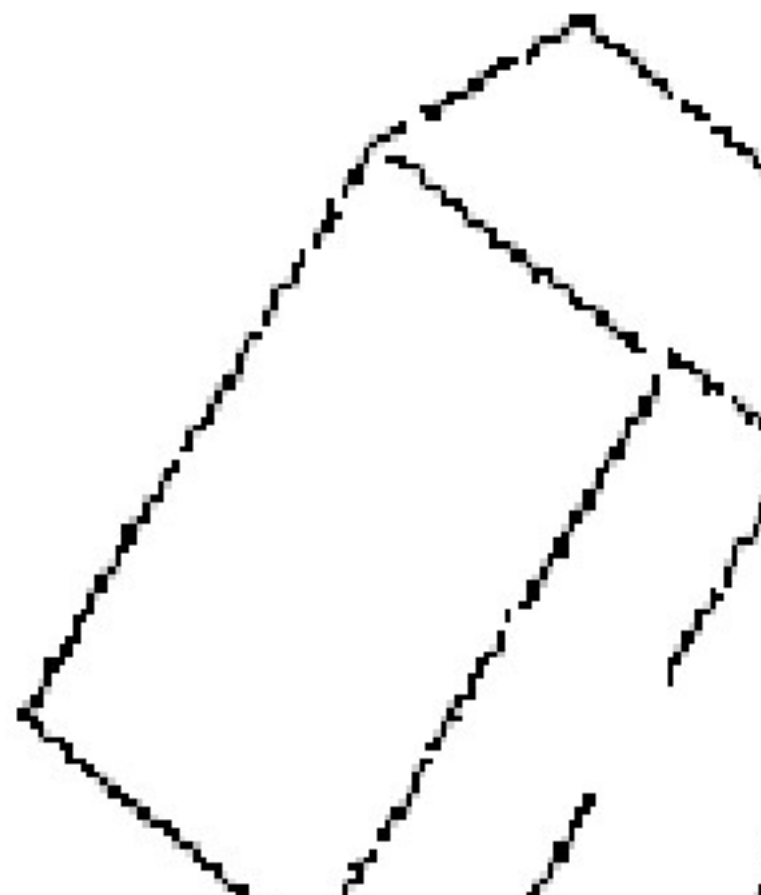

Page	Pos	Code	Description	Info
002	002	SC6-Pos.002	PIN	01/03/2003-
002	004	SC6-Pos.004	WASHER	01/03/2003-
002	006	SC6-Pos.006	FRAME	01/03/2003-
002	008	3106090	"L" PROFILE	01/03/2003-
002	010	SC6-Pos.010	NUT	01/03/2003-
002	012	3106100	PLATE	01/03/2003-
002	018	3028750	BALL GRIP	01/03/2003-
002	020	SC6-Pos.020	BASKET HOLDER BAR	01/03/2003-
002	028	3042700	SLIDE	01/03/2003-
002	052	3016940	CUTTER COVER	01/03/2003-
002	052	3031610	CUTTER COVER + GASKET	01/03/2003-
002	054	3016950	PLUG	01/03/2003-
002	056	SC6-Pos.056	MAGNET	01/03/2003-
002	060	3064890	LOCKPIN	01/03/2003-
002	062	3064900	HUB	01/03/2003-
002	062	SC6-Pos.062	HUB	01/03/2003-
002	064	3017940	BLADE CUTTER	01/03/2003-
002	064	3031590	BLADE CUTTER	01/03/2003-
002	064	3054690	BLADE CUTTER	01/03/2003-
002	064	3272810	BLADE CUTTER	01/03/2003-
002	068	SC6-Pos.068	SPACER	01/03/2003-
002	068	SC6-Pos.068	SPACER	01/03/2003-
002	072	3017950	BLADE CUTTER	01/03/2003-
002	072	3031600	BLADE CUTTER	01/03/2003-
002	072	3054700	BLADE CUTTER	01/03/2003-
002	076	3197280	TANK	01/03/2003-
002	080	3072990	REINFORCEMENT	01/03/2003-
002	080	SC6-Pos.080	REINFORCEMENT	01/03/2003-
002	090	SC6-Pos.090	FRAME	01/03/2003-
002	094	3071460	GASKET	01/03/2003-
002	102	SC6-Pos.102	MOUNTING PLATE	01/03/2003-
002	102	SC6-Pos.102	MOUNTING PLATE	01/03/2003-
002	104	3075810	MOZZO ALLUM. COMPL. C6	01/03/2003-
002	108	3176680	HUB	01/03/2003-
002	112	3042690	BELT 630X6	01/03/2003-
002	112	3042690	BELT 630X6	01/03/2003-
002	114	3019170	FOOT	01/03/2003-
002	116	SC6-Pos.116	GRID	01/03/2003-
002	136	3070350	MOTOR 230V 50HZ	01/03/2003-
002	136	SC6-Pos.136	MOTOR 110V/60Hz	01/03/2003-
002	154	SC6-Pos.154	PLATE	01/03/2003-
002	160	SC6-Pos.160	SUPPORT	01/03/2003-
002	162	SC6-Pos.162	PLATE	01/03/2003-
002	170	3065810	FINE STAINLESS STEEL	01/03/2003-
002	174	3065820	STONE	01/03/2003-
002	175	3038100	ROTOR SMOOTH PBADES	01/03/2003-
003	200	SC6-Pos.200	POWER CABLE	01/03/2003-
003	200	SC6-Pos.200	POWER CABLE	01/03/2003-
003	200	SC6-Pos.200	POWER CABLE	01/03/2003-
003	202	SC6-Pos.202	GROMMET	01/03/2003-
003	202	SC6-Pos.202	GROMMET	01/03/2003-

Page	Pos	Code	Description	Info
003	208	3023410	ASSEMBLY ELECTRONICS CARD	01/03/2003-
003	214	SC6-Pos.214	SUPPORT MICRO SWITCH	01/03/2003-
003	230	SC6-Pos.230	ELECTRONICS CARD	01/03/2003-
003	230	3038260	110V/60Hz ELECTRONICS CARD	01/03/2003-
003	262	3084980	220V 1F MICRO SWITCH	01/03/2003-
003	264	3021910	PROTECTED MICROSWITCH	01/03/2003-
003	274	SC6-Pos.274	SPACER	01/03/2003-
003	276	SC6-Pos.276	MICRO SWITCH	01/03/2003-
003	280	SC6-Pos.280	TERMINAL BLOCK	01/03/2003-
003	286	SC6-Pos.286	FILTER	01/03/2003-
003	292	3062470	MICRO SWITCH	01/03/2003-
004	001	3018180	SWITCH ASSY	01/03/2003-