	TAVOLA	REV
	IT3110	03
GS 45		

Зип Общепит

vsezip.ru

+7(812)987-03-81

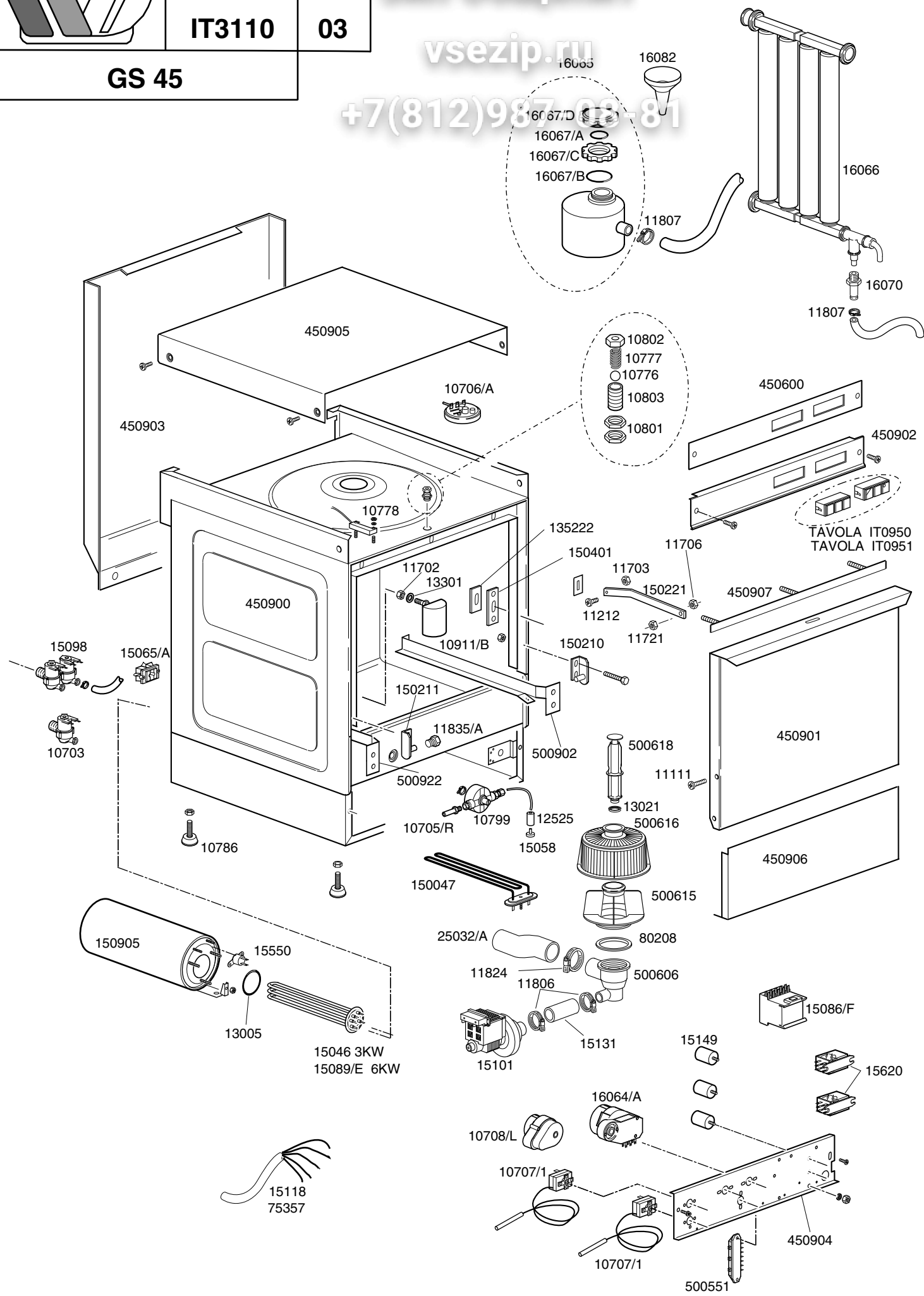

LAVASTOVIGLIE GS 45

Зип Общепит

TAVOLA

IT3110

vsezin.ru

+7(812)9160933

CODICE	DESCRIZIONE	CODICE	DESCRIZIONE
10703	Elettrovalvola singola	500615	Ghiera con innesto filtro
10776	Sfera inox d.9.52	500616	Filtro aspirazione
10777	Molla per cricco porta	500618	Assieme troppopieno
10778	Microcontatto reed	500902	Correntino interno dx
10786	Piedino M10x25 d.40 nero	500922	Correntino interno sx
10799	Dosatore brillantante	10705/R	Raccordo per tubo d.8
10801	Dado cricco porta	10706/A	Pressostato 55-30
10802	Controdado cricco porta	10707/1	Termostato 0-90° TR2
10803	Corpo cricco porta	10708/L	Timer 120"
11111	Vite M6x16 inox	10911/B	Gabbia d'aria L=75
11212	Vite autofilettante 2,9x19 inox	11835/A	Boccola in ottone filetto completo
11702	Dado M8 inox	15065/A	Fissacavo con viti
11703	Dado M4 inox	15086/F	Teleruttore 230V
11706	Dado M6 inox	15089/E	Resistenza boiler 6 Kw
11721	Dado autobloccante M6 inox	16064/A	Timer 18' depurazione
11806	Fascetta inox 25-40	16067/A	Guanizione OR tappo boccia
11807	Fascetta inox 12-22	16067/B	Guarnizione boccia sale
11824	Fascetta inox 50-70	16067/C	Ghiera boccia sale
12525	Contropeso per filtrino	16067/D	Tappo boccia sale
13005	Guarnizione OR 151	25032/A	Manicotto aspirazione
13021	Guarnizione DEM 40		
13301	Guarnizione 14x8x1,5		
15043	Resistenza boiler 3 KW		
15046	Resistenza boiler 3KW		
15058	Filtro aspirazione brillantante		
15089	Resistenza boiler 4,5KW		
15098	Elettrovalvola doppia		
15101	Pompa di scarico		
15131	Tubo rony-flex 30-450		
15149	Filtro antidisturbo F1		
15550	Termostato sicurezza		
15620	Relè in deviazione		
16065	Contenitore sale (Versione bassa)		
16066	Decalcificatore 4 elementi		
16070	Valvola non ritorno		
16082	Imbuto		
75357	Cavo alimentazione antifiama		
80208	Guarnizione 95x75x3		
135222	Battuta cerniera porta		
150047	Resistenza vasca 2,7KW		
150210	Assieme cerniera dx		
150211	Assieme cerniera sx		
150221	Asta curva per porta		
150401	Guida asta curva		
150905	Boiler		
450600	Mostrina serigrafata		
450900	Carrozzeria		
450901	Porta completa		
450902	Assieme pannello comandi		
450903	Schienale		
450904	Portacomponenti		
450905	Coperchio		
450906	Sottoporta		
450907	Angolare per guarnizione porta		
500551	Morsettiera 6 poli FV122		
500606	Pozzetto con scarico laterale dx		

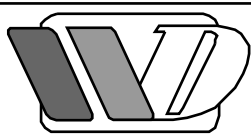

TABLE
IT3130

REV
01

GS 45

From serial Nr.0012907 on

Зип Общепит

vsezip.ru

+7(812)987-08-81



	TAVOLA IT0950	REV 00
	TASTI GS50-GS45-GS40	

Зип Общепит

vsezip.ru

+7(812)987-08-81

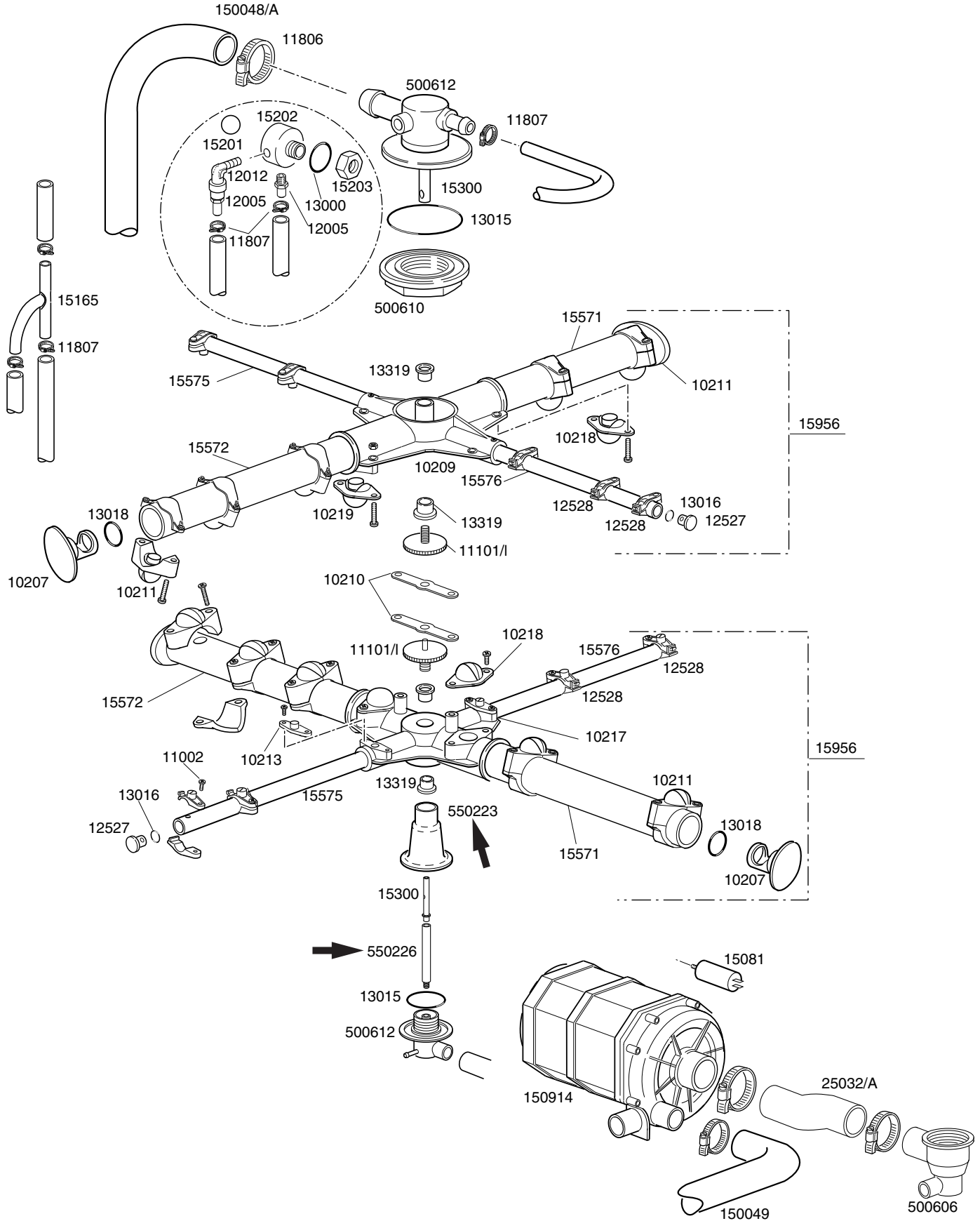
SERIE GS50-GS45-GS40 DI SERIE

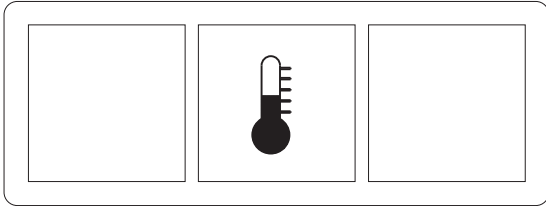

15889

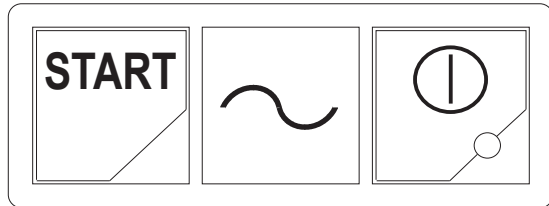

15888

SERIE GS50-GS45-GS40 POMPA DI SCARICO

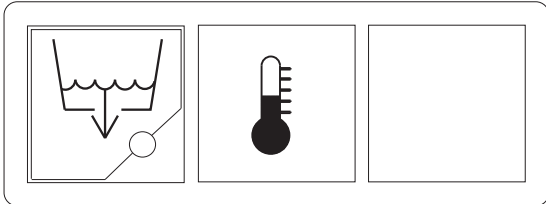

15893

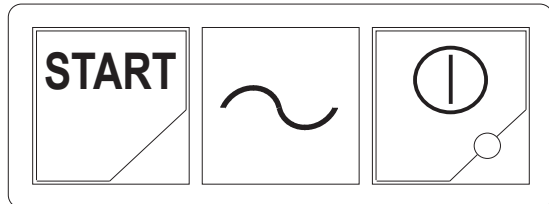

15888

SERIE GS50-GS45-GS40 DEPURAZIONE

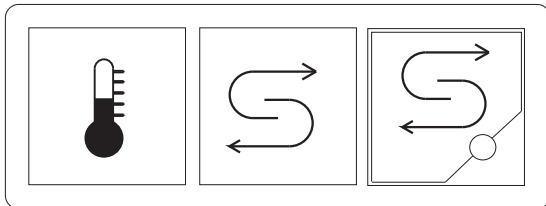

15894

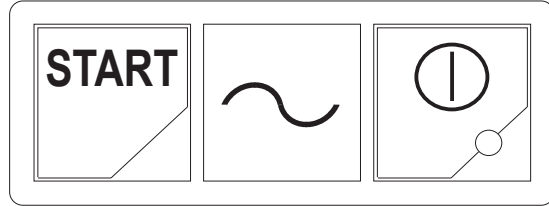

15891

SERIE GS50-GS45-GS40 DEPURAZIONE-POMPA DI SCARICO

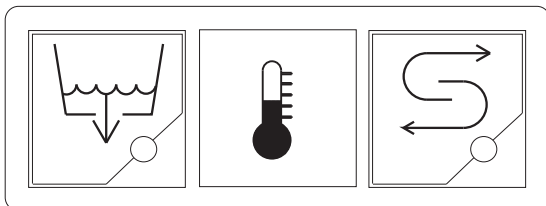

15892

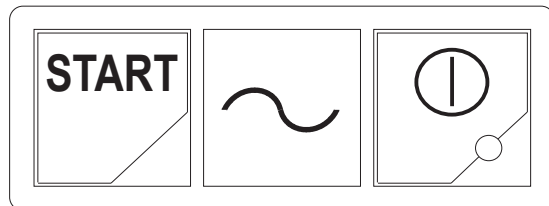

15891

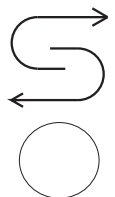

10711/B

	TAVOLA IT0951	REV 01
---	--------------------------	-------------------

TASTI GS45-GS40-GS50

Dalla matricola 99027816

Зип Общепит

vsezip.ru

+7(812)987-08-81

SERIE GS40-GS45 CALDO FREDDO COMBINATO

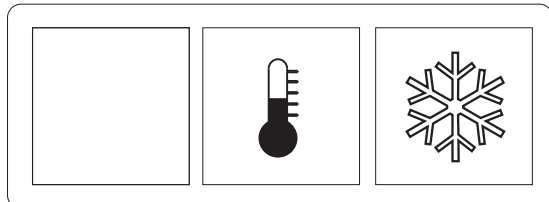

15796

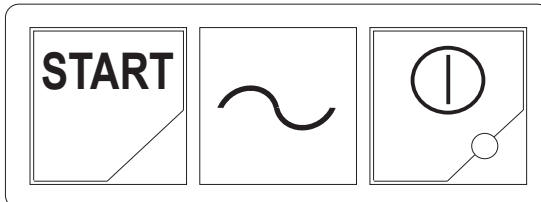

15888

SERIE GS50 RISCIAQUO FREDDO- POMPA DI SCARICO

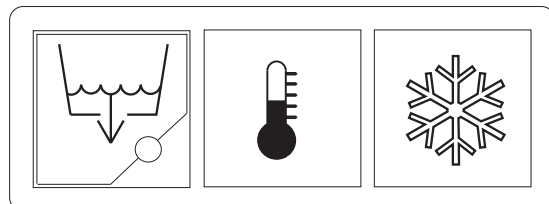

15893/A

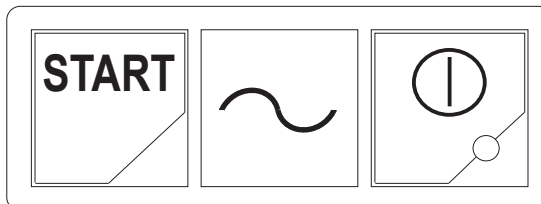

15888

CODICE

DESCRIZIONE

SERIE GS40-GS45 CALDO-FREDDO COMBINATO

- 15888 Pulsante unipolare **Start** - Spia **Ciclo** - Interruttore bipolare **0-1**
- 15796 Pulsante deviatore **Freddo** - Spia **Temperatura** -vuoto

SERIE GS50 RISCIAQUO CALDO-FREDDO /POMPA DI SCARICO

- 15893/A Pulsante bipolare **Scarico**- spia **Temperatura**- Pulsante deviatore **Freddo**
- 15888 Pulsante unipolare **Start** - Spia **Ciclo** -Interruttore bipolare **0-1**