

Зип Общепит

vsezip.ru

+7(812)987-08-81

# COOKING APPLIANCES

COOKING LINES

TYPE: CT

Accessories

WITHOUT ACCESSORY

---

## Spare Parts Manual

---

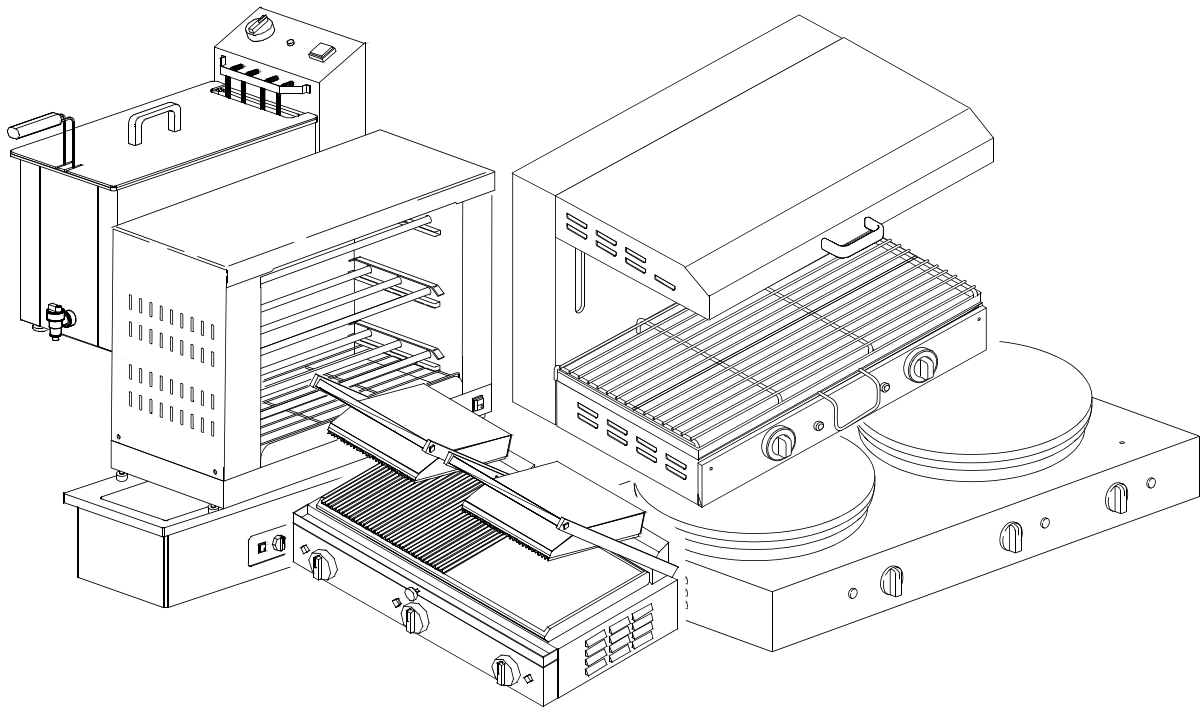

---

S/N:

Valid from:07/2006

Rev.: 7.0

---

**INFORMAZIONI GENERALI**

Questo catalogo serve per richiedere con esattezza le parti di ricambio

Nelle ordinazioni indicare:

1) il numero dei codici dei particolari seguito dalla descrizione e la quantità desiderata;

2) Il codice alfa-numerico presente nella seconda colonna della tabella ;

**I disegni delle parti di ricambio sono solo indicativi e non rappresentano il pezzo in oggetto.**

**I dati contenuti in questo catalogo sono indicativi e possono essere soggetti a modifiche senza impegno di preavviso.**

**ALLGEMEINE INFORMATIONEN**

Dieser Ersatzteilkatalog dient zur genauen Angabe der Teile bei Ersatzteilbestellungen.

Bei Ersatzbestellung ist folgendes anzugeben:

1) Die Bestellnummer der Ersatzteile mit der entsprechenden Beschreibung genaue Menge;

2) Der alpha-numerischer Code auf der zweiten Reihe in dein Sculd;

**Die Zeichnungen der Ersatzteile sind nur als Hinweise gedacht und stellen nicht das betroffene Teil dar.**

**Bei den im Katalog angeführten Daten handelt es sich um Anhaltsdaten, die jederzeit, ohne Vorankündigung, geändert werden können.**

**GENERAL INFORMATION**

The present spare parts order exactly the right spare parts

When ordering specify:

1) the part's code number followed by its description and quantity needed;

2) The alpha-numeric code is in the second column in the chart;

**Spare parts drawings are general and do not represent the part.**

**The contents of this catalogue are general and can undergo changes without prior notice.**

**INFORMACIONES GENERALES**

El presente catálogo sirve para pedir con exactitud las partes de repuesto

En los pedidos se debe indicar:

1) el número de código de la parte y a continuación la descripción cantidad deseada;

2) El código alfanumerico presente en la segnada columna de la tabla;

**Los diseños de las partes de recambio son solo indicativos y no representan la pieza en cuestión.**

**Los datos contenidos en el presente catálogo son indicativos y pueden modificarse sin aviso previo.**

**INFORMATIONS GENERALES**

Ce catalogue permet de commander correctement les pièces détachées

Les commandes doivent être passées en indiquant:

1) le numero de code des pièces détachées suivi de leur description quantité désirée;

2) le code alphanumérique dans la deuxième colonne du tableau;

**Les plans des pièces détachées sont fournis seulement à titre indicatif et ne représentent pas la pièce concernée.**

**Les données de ce catalogue sont citées seulement à titre indicatif et peuvent être l'objet de modifications sans avis préalable.**

**ESEMPIO  
EXAMPLE  
EXEMPLE  
BEISPIEL**

Rif.	Codici
MODULE:Particolari	
10505	540903
10510	540908
10515	15065/A
10520	540086
10525	540028



**Note**

Tutte le informazioni riportate si intendono aggiornate alla data di stampa. Il Produttore si riserva il diritto di apportare qualsiasi modifica richiesta dallo sviluppo evolutivo dei suddetti prodotti.

Per la sicurezza, la garanzia, l'affidabilità ed il valore della lavastoviglie usa solo ricambi originali. **Per alcuni codici, sono richieste quantità minime d'ordine.**



**Attenzione**

Questo libretto è parte integrante della lavastoviglie e, in caso di passaggio di proprietà, deve essere consegnato al nuovo acquirente.



**Remarque**

Toutes les informations contenues dans ce manuel s'entendent mises à jour à la date d'impression. En raison du développement constant de ses produits, usine se réserve le droit d'apporter à tout instant les modifications qu'elle jugera utiles.

Pour la sécurité, la garantie, la fiabilité et la valeur de votre lavevaisselles n'utilisez que des pièces de rechange d'origine. **Pour quelque référence on demande un minimum de pièces par commande**



**Attention**

Ce manuel doit être considéré comme partie intégrante de la lavevaisselles, en cas de transfert de propriété, doit toujours être remis au nouveau propriétaire.



**Note**

The information contained herein is valid at the time of going to print. The Company reserves the right to make any changes required by the future development of the above-mentioned products.

For your safety, as well as to preserve the warranty reliability and worth of your dishwashers, use original spare parts only. **For some codes a minimum quantity for order is required.**



**Warning**

This manual forms an integral part of the dishwashers and - if a transfer of title occurs - must always be handed over to the new owner.



**Hinweis**

Die Der Hersteller behält sich das Recht vor, jegliche, durch eine Weiterentwicklung der genannten Produkte bedingte Änderungen vornehmen zu können.

Verwenden Sie für Ihre Sicherheit, die Garantie, die Zuverlässigkeit und den Wert Ihrer machine originale Ersatzteile. **Für bestimmte Code nummer werden mindesten bestellungen verlangt.**



**Achtung**

Diese Betriebsanleitung ist Bestandteile des machine und muss bei seinem Weiterverkauf dem neuen Besitzer ausgehändigt werden.

vsezip.ru  
+7(812)987-08-81



**Code** DW 999XYYYY **CL/Part**

**Model DESCRIPTION**

**S/N** DW A 1015770 **Type** .....

400V 3N 50HZ 8A  
3500W 500W

**IPX3**  16A

**200-500 kPa**

Pressione Dinamica alimentazione idrica  
Pression dynamique arrivée d'eau  
Dynamic pressure water supply  
Dynamischer Druck asserreinlauf

Pressione dinamica vapore saturo  
Pression dynamique vapore satueèè  
Dymanischer Druck gesattigter Dampf  
Pression Dinamica Vapor Saturado

**TECHICAL SPECIFICATION**

**MADE IN ITALY**

Temperatura massima acqua in ingresso **60°C**  
Temperature max eau a l'entre  
Maximale Temperatur Wasseranschlù  
Maximum Water temperature in-feeding

Model 

S/N 

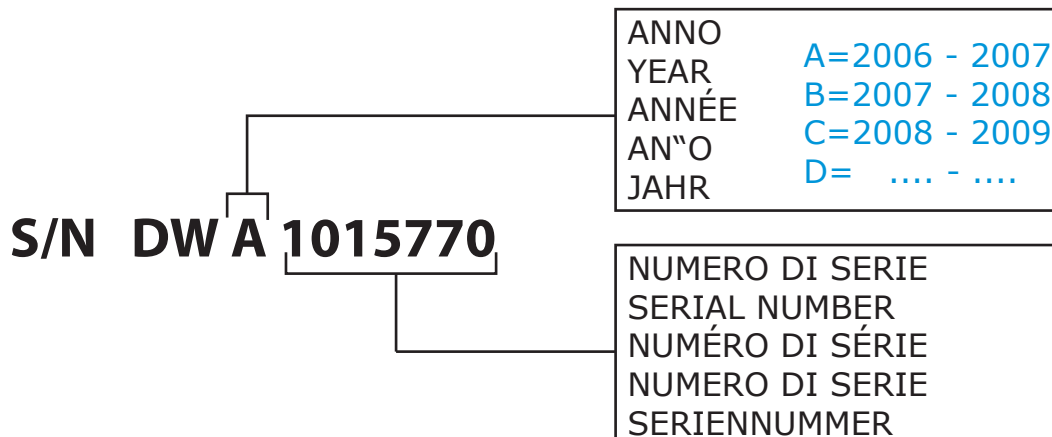
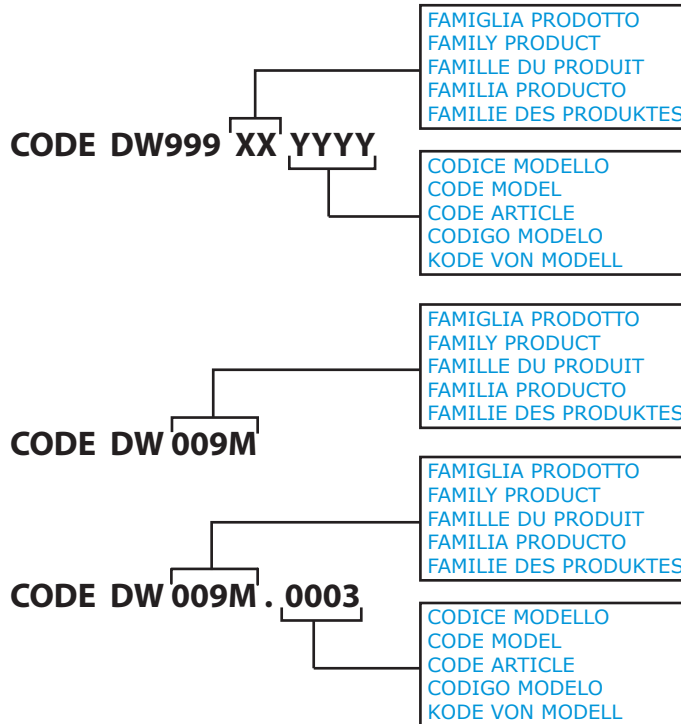

Spare parts

---

**Зип Общепит**

**vsezip.ru**

**+7(812)987-08-81**

vsezip.ru

+7(812)987-08-81

## 1. Spare parts

Toaster F6 .....	5
Toaster F60 ( TK-60P) .....	7
Toaster F60 ( TK-60P) .....	9
Toaster F12 .....	11
Toaster F120 ( TK-120 P) .....	13
Toaster F120 ( TK-120 P) .....	15
Crepe-X1 ( TK-20 ) .....	17
Crepe-X2 ( TK-21 ) .....	19
Single grill ( K1-L + K1-R ) .....	21
Double grill ( K2-L + K2-R + K2-M ).	25
Salamander S1 .....	29
Salamander S2 .....	31
Bain Marie BM100-200-300 .....	33
5M-6M/T-8T deep-fryer .....	37
5+5M-6+6M/T-8+8T deep-fryer .....	39

vsezip.ru

+7(812)987-08-81

## 1.1 Voltage codes

Volt	Voltage code
A	3/N/PE~380-400V 50-60Hz
D	3/PE~200-210V 50-60Hz
F	2/PE~220-240V 50-60Hz
G	3/N/PE~415V 50-60Hz
H	3/PE~220-230V 50-60Hz
K	3/PE~380-400V 50-60Hz
L	3/PE~415V 50-60Hz
M	3/PE~440V 60Hz
P	1/N/PE~220-230V 50-60Hz
R	2/PE~220-240V 50-60Hz
U	1/N/PE~240V 50-60Hz
V	3/PE~240V 50-60Hz
W	1/N/PE~100-110V 50-60Hz

## 1.2 Product codes

Product code	Full name
Model codes	
ct	COOKING LINES
Type codes	
CT	CT
Accessory codes	
wa	WITHOUT ACCESSORY





vsezip.ru

ID	P-code	SN from	SN to	Mod.	Acces.	Volt	Description
<b>Module: Toaster F12</b>							
3500	8006		-				Top protection grid
3505	8007		-				Lower protection grid
3510	8008		-				Pliers
3515	8017		-				Drawer knob screw
3520	8018		-				Drawer knob
3525	8022		-				4,2x9,5 TCB cover screw
3530	8026		-				Complete insulator
3535	8029		-				Timer knob
3540	8030		-				Timer
3545	8050		-				Single grid with handle
3550	8063		-				Small foot
3555	8075		-				450W single quartz heating element
3560	8080		-				Stainless steel body
3565	8082		-				Stainless steel drawer
3570	8083		-				Shell covering
3575	8085		-				False ceiling
3580	8086		-				Bottom protection
3585	8090		-				Top insulating panel
3590	8091		-				Lower insulating panel
3595	8092		-				Side insulating panel
3600	15861		-				0-1 green single key switch
3605	15065/A		-				Cable-fastener with screw

ct=COOKING LINES

CT=CT

wa= WITHOUT ACCESSORY

A=3/N/PE~380-400V 50-60Hz, D=3/PE~200-210V 50-60Hz, F=2/PE~220-240V 50-60Hz, G=3/N/PE~415V 50-60Hz, H=3/PE~220-230V 50-60Hz, K=3/PE~380-400V 50-60Hz, L=3/PE~415V 50-60Hz, M=3/PE~440V 60Hz, P=1/N/PE~220-230V 50-60Hz, R=2/PE~220-240V 50-60Hz, U=1/N/PE~240V 50-60Hz, V=3/PE~240V 50-60Hz, W=1/N/PE~100-110V 50-60Hz