

Зип Общежит
www.zip.ru
+7 (812) 987 08-81

LAVASTOVIGLIE
DISHWASHER
LAVE-VAISSELLE
885 - 120 - 160 - 240

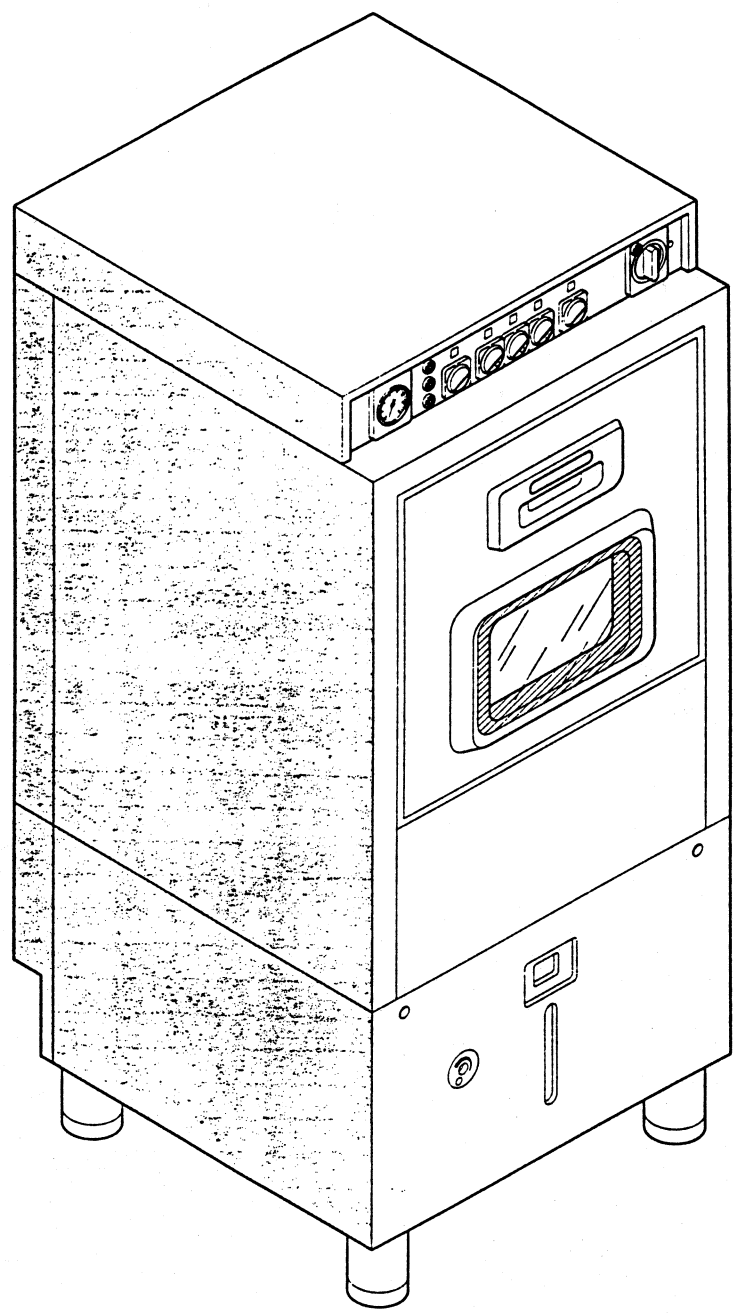

10/95

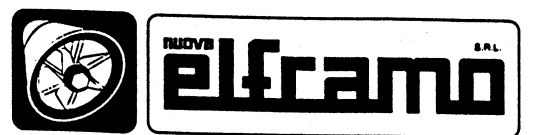

24127 BERGAMO (ITALIA) - VIA VERGA, 24
TELEFONO 035/4548111 - TELEFAX 035/4548150



NUOVE
elframo S.p.A.

Зип Общепит

LAVASTOVIGLIE

120-160-240 cm

TAV. 2

+7(812)987-08-81

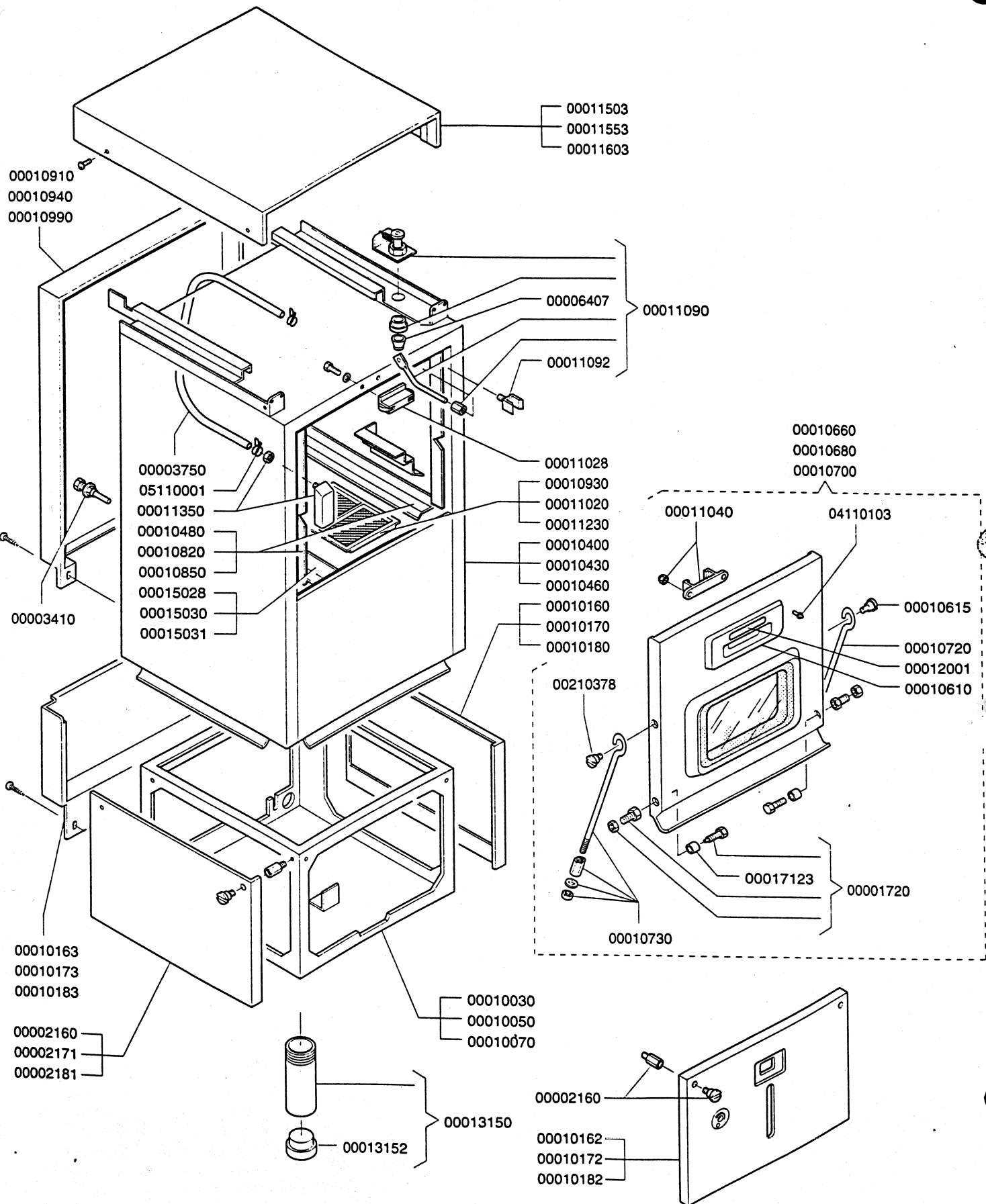

DISTINTA PER RICAMBIO (Per l'ordinazione riferire sempre il tipo/modello e l'anno di fabbricazione)
SPARE PARTS LIST (When ordering pls always indicate type, model and production year)
LISTE PIÈCES DÉTACHÉES (En cas de commande indiquer le modèle et l'an de fabrication)

TAV.
2

COD.	DENOMINAZIONE	DENOMINATION	DÉNOMINATION
00001720	Gruppo cerniere e bussola	Door hinge pin complete	Groupe charnières et douille
00002160	Distanziatore pannello	Panel securing screw	Boulon panneau
00002180	Campana pressostato	Air receiving box	Gloche pressostat
00003410	Guaina per termometro	Thermometer phial sleeve	Joint pour thermomètre
00003750	Tubetto pressostato	Prassure stat tube	Tuyau pressostat
00006407	Cuffia	Door switch lever sleeve	Coiffe
00010030	Telaio 120	Machine chasis for model 120	Chassis 120
00010050	Telaio 160	Machine chasis for model 160	Chassis 160
00010070	Telaio 240	Machine chasis for model 240	Chassis 240
00010160	Pannello laterale dx 160	Righthand side panel for model 160	Panneau lateral droite 160
00010161	Pannello laterale sx 160	Left hand side panel for model 160	Panneau lateral gauche 160
00010162	Pannello anteriore 160	Front facia panel for model 160	Panneau antérieur 160
00010163	Carter posteriore 160	Rear lower panel for model 160	Carter posterieur 160
00010170	Pannello laterale dx 120	Righthand side panel for model 120	Panneau lateral droite 120
00010171	Pannello laterale sx 120	Left hand side panel for model 120	Panneau lateral gauche 120
00010172	Pannello anteriore 120	Front facia panel for model 120	Panneau antérieur 120
00010173	Carter posteriore 120	Rear lower panel for model 120	Carter posterieur 120
00010180	Pannello laterale dx 240	Righthand side panel for model 240	Panneau lateral droit 240
00010181	Pannello laterale sx 240	Left hand side panel for model 240	Panneau lateral gauche 240
00010182	Pannello anteriore 240	Front facia panel for model 240	Panneau antérieur 240
00010183	Carter posteriore 240	Rear lower panel for model 240	Carter posterieur 240
00010400	Cassone 240	Machine case for model 240	Caisson 240
00010430	Cassone 120	Machine case for model 120	Caisson 120
00010460	Cassone 160	Machine case for model 160	Caisson 160
00010480	Coppia guide cestello 160	Basket runner for model 160	Couple guides panier 160
00010610	Maniglia plastica	Plastic door handle	Manette plastique
00010660	Portella 120	Complete door for model 120	Porte 120
00010680	Portella 160	Complete door for model 160	Porte 160
00010700	Portella 240	Complete door for model 240	Porte 240
00010720	Tirante portella dx	Right hand door stay	Entretoise porte droite
00010730	Tirante portella sx	Left hand door stay	Entretoise porte gauche
00010820	Coppia guide cestello 120	Basket runner for model 120	Couple guides panier 120
00010850	Coppia guida cestello 240	Basket runner for model 240	Cuple guides 240
00010910	Schienale 120	Back panel for model 120	Arrière 120
00010930	Filtro di superficie 120	Surface tray filter for model 120	Filtre de surface 120
00010940	Schienale 160	Back panel for model 160	Arrière 160
00010990	Schienale 240	Back panel for model 240	Arrière 240
00011020	Filtro di superficie 160	Surface tray filter for model 160	Filtre de surface 160
00011028	Blocchetto di chiusura posteriore	Sprung door catch	Bloc de fermeture posterieur
00011040	Blocchetto di chiusura anteriore	Clasp door catch	Bloc de fermeture antérieur
00011090	Gruppo microportella	Door micro switch assembly	Groupe microporte
00011092	Forcella di protezione	Door micro switch assembly guard	Fourche de protection
00011230	Filtro di superficie 240	Surface tray filter for model 240	Filtre de surface
00011503	Coperchio quadro elettrico 120	Top panel for model 120	Couvercle tableau électrique 120
00011553	Coperchio quadro elettrico 160	Top panel for model 160	Couvercle tableau électrique 160
00011603	Coperchio quadro elettrico 240	Top panel for model 240	Couvercle tableau électrique 240
00012001	Targa maniglia - 00012000	Door handle logo-00012000	Bandeau poignee - 00012000
00013150	Gamba con piedino	Complete leg	Jambe avec pied
00013152	Piedino	Rubber foot	Pied
00015028	Supporto collettore inferiore 240	Tray filter support for model 240	Support collecteur inferieur 240
00015030	Supporto collettore inferiore 120	Tray filter support for model 120	Support collecteur inferieur 120
00015031	Supporto collettore inferiore 160	Tray filter support for model 160	Support collecteur inferieur 160
00017123	Anello di spallamento	Hinge pin sleeve	Anneau de butée
00210378	Perno per tirante portella	Door stay securing screw	Boulon pour entretoise porte
04110103	Rivetto inox 3,2 mm	Stainless steel rivet 3,2 mm	Rivet inox 3,2 mm
05110001	Fascetta D=7	Jubilee clip Dia=7	Collier D=7



elcamo

Зип Общепит
LAVASTOVIGLIE
120-160
vsezip.ru

TAV. 4

+7(812)987-08-81

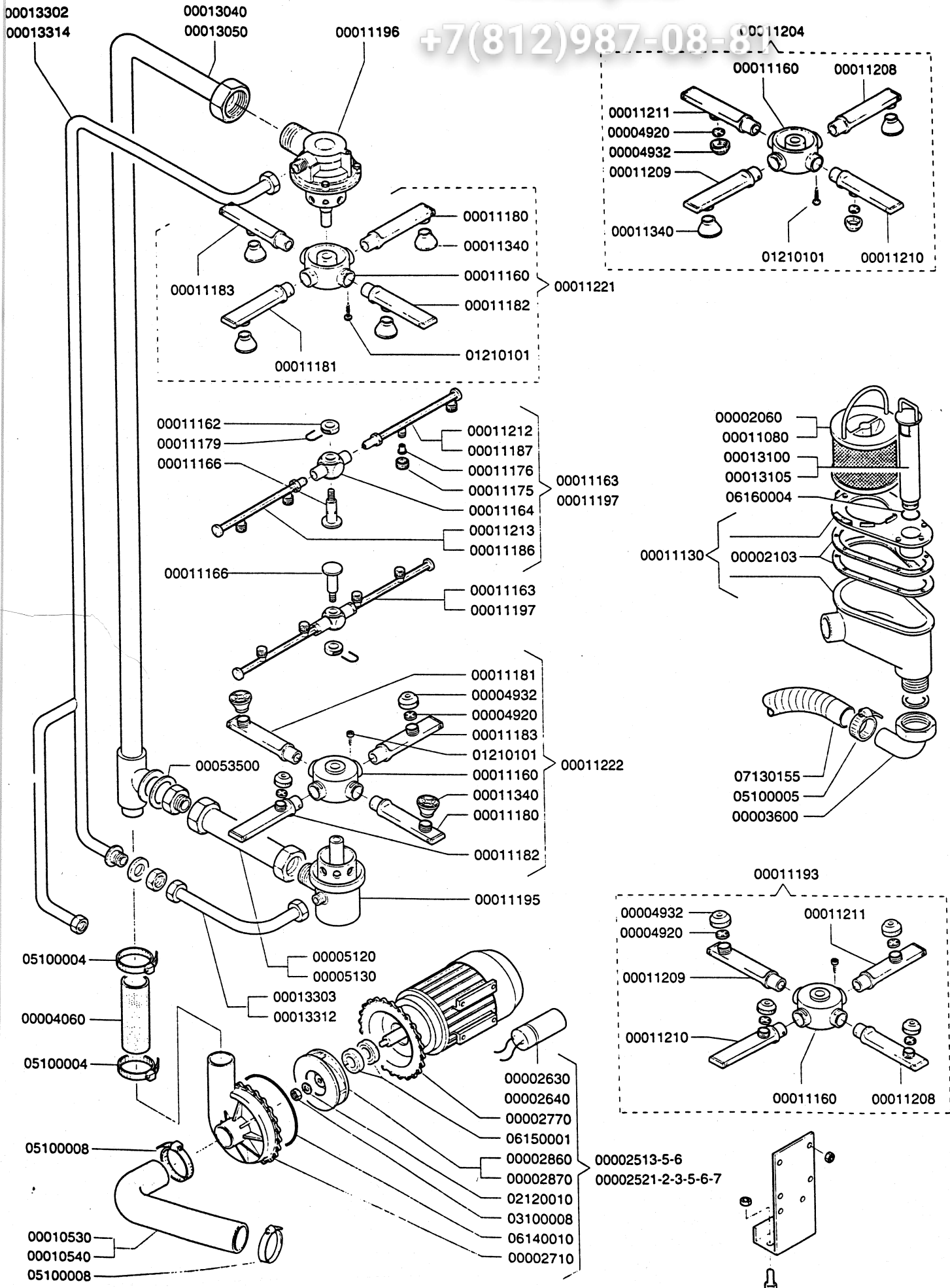

DISTINTA PER RICAMBIO (Per l'ordinazione indicare sempre il tipo/modello e l'anno di fabbricazione)
SPARE PARTS LIST (When ordering pls always indicate type/model and production year)
LISTE PIÈCES DÉTACHÉES (En cas de commande indiquer le modèle et l'an de fabrication)

TAV.
4

COD.	DENOMINAZIONE	DENOMINATION	DÉNOMINATION
00002060	Filtro pompa lavaggio 120	Wash pump filter 120	Filtre pompe 120
00002103	Guarnizione	Wash/drain sump gasket	
00002513	Elettropompa 1 220/240-50 monofase - 00002519	Wash pump 1HP 220V 50Hz 1PH-00002519	Pompe monophasé 1 220/240-50 - 00002519
00002515	Elettropompa 1 220-60 monofase - 00002519	Wash pump 1HP 220V 60Hz 1PH-00002519	Pompe monophasé 1 220-60 - 00002519
00002516	Elettropompa 1 115-60 monofase - 00002519	Wash pump 1HP 115V 60Hz 1PH-00002519	Pompe monophasé 1 115-60 - 00002519
00002521	Elettropompa 1,5 380/415-50 - 00002529	Wash pump 1.5HP 380/415V 50Hz 3PH-00002529	Pompe monophasé 1 115-60 - 00002519
00002522	Elettropompa 1,5 380/440-60 - 00002529	Wash pump 1.5HP 380/415V 60Hz 3PH-00002529	Pompe 1,5 380/415-50 - 0002529
00002523	Elettropompa 1,5 220/240-50 monofase - 00002529	Wash pump 1.5HP 220/240V 50Hz 1PH-00002529	Pompe 1,5 380/415-60 - 0002529
00002525	Elettropompa 1,5 220-60 monofase - 00002529	Wash pump 1.5HP 220V 60Hz 1PH-00002529	Pompe monophasé 1,5 220/240-50 - 00002529
00002526	Elettropompa 1,5 115-60 monofase - 00002529	Wash pump 1.5HP 115V 60Hz 1PH-00002529	Pompe monophasé 1,5 220-60 - 00002529
00002527	Elettropompa 1,5 115-60 - 00002529	Wash pump 1.5HP 115V 60Hz - 00002529	Pompe monophasé 1,5 115-60 - 00002529
00002630	Condensatore 20 µF 1	Capacitor 20 µF 1HP	Pompe 1,5 115-60 - 00002529
00002640	Condensatore 25 µF 1,5 240M	Capacitor 25 µF 1.5HP 240M	Condensateur 20 µF1
00002710	Chiocciola	Impellor cover	Condensateur 25 µF1,5 240M
00002770	Corpo pompa flangiato	Impellor rear cover	Écargot
00002860	Girante 1	Impellor 1HP	Corps pompe
00002870	Girante 1,5	Impellor 1,5HP	Turbine 1
00004000	Raccordo angolo	Drain outlet elbow	Turbine 1,5
00004060	Tubo premente	Wash pump outlet hose	Turbine 1,5
00004920	Anima ugello lavaggio	Wash jet insert	Raccord angle
00004932	Ugello di lavaggio	Wash jet	Tube refoulant
00005120	Tubo raccordo 1" 1/2 120	Lower wash connection tube 1"1/2 for model 120	Corps jet lavage
00005130	Tubo raccordo 160	Lower wash connection tube for model 160	Jet de lavage
00010530	Manicotto aspirante 160 - 240	Wash pump inlet pipe for model 160/240	Tube raccord 1" 1/2 120
00010540	Manicotto aspirante 120	Wash pump inlet pipe for model 120	Tube raccord 160
00011080	Filtro alto	Wash pump filter	Durite aspirante 160-240
00011130	Gruppo vaschetta alta	Complete wash/drain sump	Durite aspirante 120
00011160	Collettore rotante lavaggio	Rotating wash boss	Filtre haut
00011162	Piattello	Rinse boss washer	Groupe fond cuve haute
00011163	Gruppo risciacquo 160 completo	Complete rinse arm for model 160	Collecteur lavage rotatif
00011164	Collettore rotante risciacquo	Rotating rinse boss	Ecrou
00011166	Perno di bloccaggio	Wash/rinse fixing bolt	Group rincage 160 complet
00011175	Ugello di risciacquo	Rinse jet	Collecteur rotatif rincage
00011176	Anima ugello di risciacquo	Rinse jet insert	Broche de bloqua
00011179	Graffetta piattello	Washer fixing clip	Jet rincage
00011180	Braccio lavaggio lungo inclinato 160	Wash arm with long inclined jet for model 160	Corps jet rincage
00011181	Braccio lavaggio lungo diritto 160	Wash arm with long straight jet for model 160	Agrafe disque
00011182	Braccio lavaggio corto inclinato 160	Wash arm with short inclined jet for model 160	Bras lavage long incliné 160
00011183	Braccio lavaggio medio diritto 160	Wash arm with medium straight jet for model 160	Bras lavage long direct 160
00011186	Braccio risciacquo 1° diritto 160	Rinse arm with straight jet for model 160	Bras lavage court incliné 160
00011187	Braccio risciacquo 1° inclinato 160	Rinse arm with inclined jet for model 160	Bras lavage moyen direct 160
00011195	Collettore inferiore 1" 1/2	Lower fixed wash boss 1" 1/2	Bras lavage direct 160
00011193	Crociera inferiore 120	Complete lower wash arm for model 120	Bras rinçage incliné 160
00011196	Collettore superiore 1" 1/2 flangiato	Top fixed wash boss 1" 1/2	Collecteur inferieur 1" 1/2
00011197	Gruppo risciacquo completo 120	Complete rinse arm for model 120	Crochet inferieur 120
00011204	Crociera superiore 120	Complete top wash arm for model 120	Collecteur superieur 1" 1/2
00011208	Braccio lavaggio lungo inclinato 120	Wash arm with long inclined jet for model 120	Groupe rinçage complet 120
00011209	Braccio lavaggio lungo diritto 120	Wash arm with long straight jet for model 120	Crochet superieur 120
00011210	Braccio lavaggio corto inclinato 120	Wash arm with short inclined jet for model 120	Bras lavage long incliné 120
00011211	Braccio lavaggio medio diritto 120	Wash arm with medium straight jet for model 120	Bras lavage long direct 120
00011212	Braccio risciacquo 1° inclinato 120	Rinse arm with inclined jet for model 120	Bras lavage court incliné 120
00011213	Braccio risciacquo 1° diritto 120	Rinse arm with straight jet for model 120	Bras lavage moyen direct 120
00011221	Crociera superiore 160	Complete top wash arm for model 160	Bras rincage incliné 120
00011222	Crociera inferiore 160	Complete lower wash arm for model 160	Bras rincage direct 120
00011340	Ventola di lavaggio bassa	Turbo wash jet	Crochet superieur 160
00013040	Colonna lavaggio 120	Top wash supply pipe for model 120	Crochet inferieur 160
00013050	Colonna lavaggio 160	Top wash supply pipe for model 160	Tete de lavage basse
00013100	Tappo troppopieno 160	Overflow pipe for model 160	Colonne lavage 120
			Colonne lavage 160
			Bonde 160



NUOVE elframo S.p.A.

Зип Общепит LAVASTOVIGLIE 120-160

vsezip.ru

TAV. 4

+7(812)987-08-81

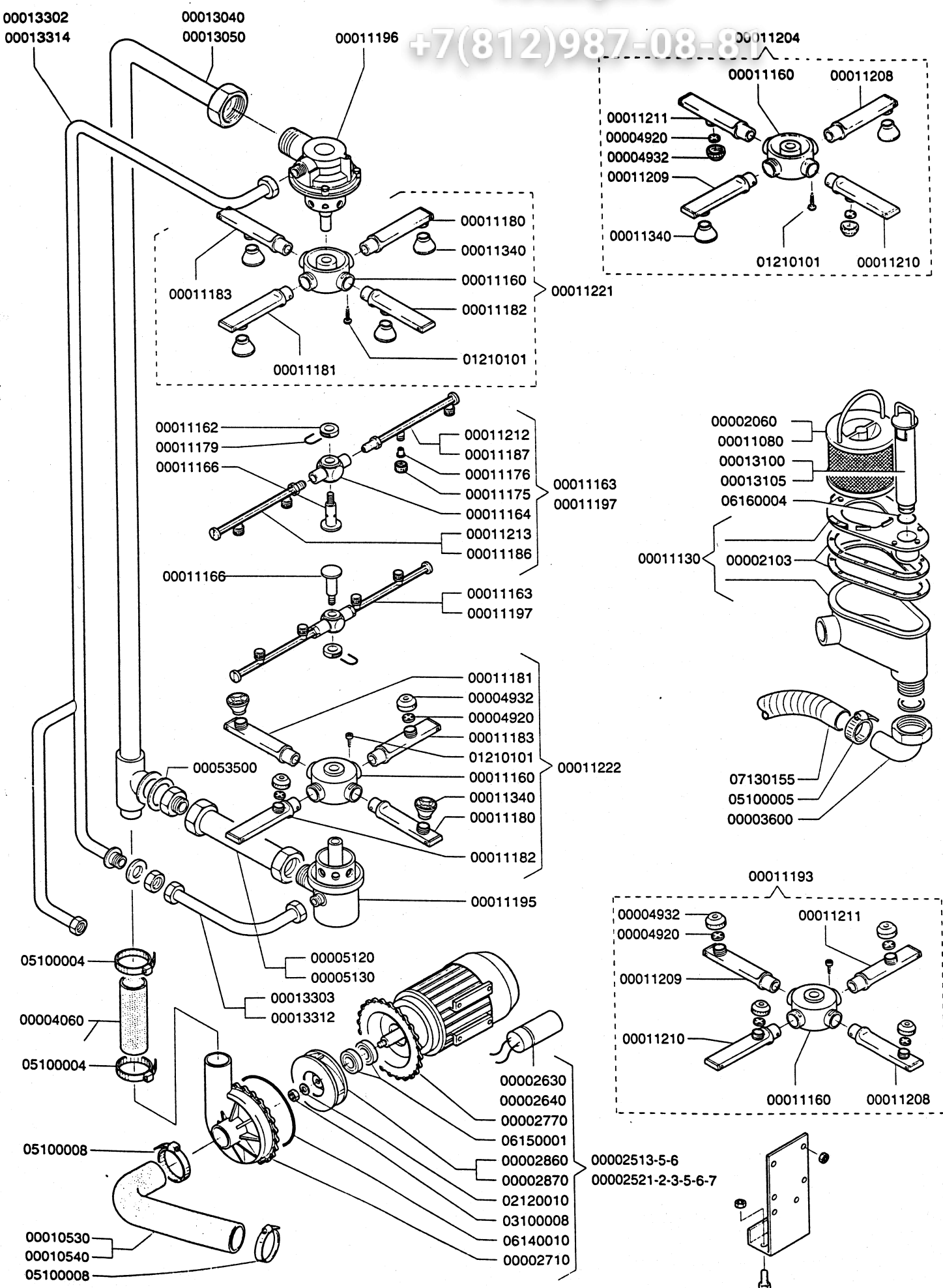



RUSSIA
elcamo S.p.A.

Зип Общепит LAVASTOVIGLIE vs160

TAV. 8

+7(812)987-08-81

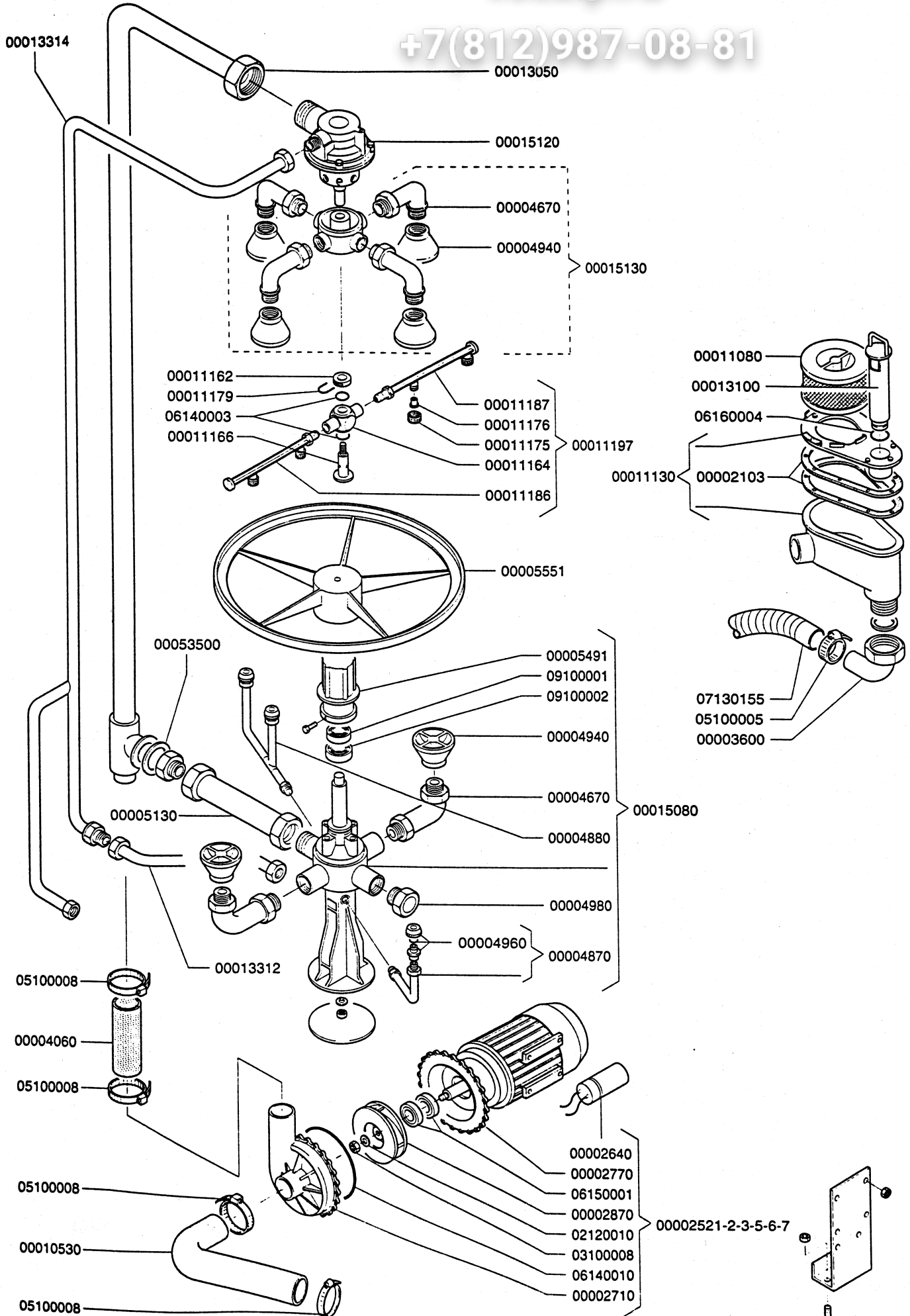

DISTINTA PER RICAMBIO (Per l'ordinazione indicare sempre il tipo/modello e l'anno di fabbricazione)
SPARE PARTS LIST (When ordering pls always indicate type/model and production year)
LISTE PIÈCES DÉTACHÉES (En cas de commande indiquer le modèle et l'an de fabrication)

TAV.

8

COD.	DENOMINAZIONE	DENOMINATION	DÉNOMINATION
00002103	Guarnizione	Wash/drain sump gasket	Joint
00002521	Elettropompa 1,5 380/415-50 - 00002529	Wash pump 1.5HP 380/415V 50Hz 3PH - 00002529	Pompe 1,5 380/415-50 - 00002529
00002522	Elettropompa 1,5 380/440-60 - 00002529	Wash pump 1.5HP 380/440V 50Hz 3PH - 00002529	Pompe 1,5 380/440-60 - 00002529
00002523	Elettropompa 1,5 220/240-50 monofase - 00002529	Wash pump 1.5HP 220/240V 50Hz 1PH - 00002529	Pompe monophasé 1,5 220/240-50 - 00002529
00002525	Elettropompa 1,5 220-60 monofase - 00002529	Wash pump 1.5HP 220V 60Hz 1PH - 00002529	Pompe monophasé 1,5 220-60 - 00002529
00002526	Elettropompa 1,5 115-60 monofase - 00002529	Wash pump 1.5HP 115V 60Hz 1PH - 00002529	Pompe monophasé 1,5 115-60 - 00002529
00002527	Elettropompa 1,5 115-60 - 00002529	Wash pump 1.5HP 115V 60Hz - 00002529	Pompe 1,5 115-50 - 00002529
00002640	Condensatore 25 µF 1,5 240M	Capacitor 25 µF 1,5 240M	Condensateur 25 µF 1,5 240M
00002710	Chiocciola	Impellor cover	Écargot
00002770	Corpo pompa flangiato	Impellor rear cover	Corps pompe
00002870	Girante 1,5	Impellor 1,5HP	Turbine 1,5
00003600	Raccordo angolo	Drain outlet elbow	Raccord angle
00004060	Tubo premente	Wash pump outlet hose	Tube refoulant
00004670	Braccio lavaggio pipa	Lower wash jet elbow	Coude bras lavage
00004870	Braccio risciacquo inferiore	Lower rinse arm	Bras rincage inferieur
00004880	Braccio risciacquo doppio	Lower rinse arm with double jet	Bras rincage double
00004940	Ugello lavaggio a ventola	Turbo wash jet	Tete de lavage rotatif
00004960	Ugello risciacquo	Lower rinse jet	Jets rincage
00004980	Tappo G 1"	Plug 1"	Bouchon 1"
00005130	Tubo raccordo	Lower wash connection tube 1" 1/2 for model 160	Tube raccord
00005491	Mozzo portaruota ø 47	Wheel bearing housing DIA=47	Moyeu porte roue D=47
00005551	Ruota portacestello ø 47	Basket wheel DIA=47	Roue porte panier D=47
00010530	Manicotto aspirante	Wash pump inlet pipe for model 160/240	Durite aspirante
00011080	Filtro alto	Upper filter	Filtre haut
00011130	Gruppo vaschetta alta	Complete wash/drain sump	Groupe cuve haut
00011162	Piattello	Rinse boss washer	Écrou
00011163	Gruppo risciacquo completo	Complete rinse arm for model 160	Groupe rincage complet
00011164	Collettore rotante risciacquo	Rotating rinse boss	Collecteur rincage rotatif
00011166	Perno di bloccaggio	Wash/rinse fixing bolt	Broche de blocage
00011175	Ugello di risciacquo	Rinse jet	Jets rincage
00011176	Anima ugello di risciacquo	Rinse jet insert	Corp jet rincage
00011179	Graffetta piattello	Washer fixing clip	Agrafe écrou
00011186	Braccio risciacquo 1° diritto 160	Rinse arm with straight jet 1° 160	Bras rincage 1° direct 160
00011187	Braccio risciacquo 1° inclinato 160	Rinse arm with inclined 1° 160	Bras rincage 1° incliné 160
00013050	Colonna lavaggio	Top wash supply pipe for model 160	Colonne lavage
00013100	Tappo troppopieno	Overflow pipe for model 160	Bonde
00013312	Tubetto risciacquo inferiore	Lower rinse pipe	Tube rincage inferieur
00013314	Colonna risciacquo completa	Top rinse supply pipe for model 160	Tube rincage complet
00015080	Gruppo inferiore 1" 1/2 di lavaggio	Complete lower wash assy 1" 1/2	Groupe inferieur 1" 1/2 lavage
00015120	Collettore superiore flangiato 1" 1/2	Fixed top wash boss 1" 1/2	Collecteur superieur 1" 1/2
00015130	Crociera superiore 160 - 240	Complete wash arm assy 160-240	Crochet superieur 160-240
00053500	Guarnizione 1" 1/2 59x45x2	Wash pipe gasket 1" 1/2 59x45x2	Joint 1" 1/2 59x45x2
02120010	Rosetta inox M10 UNI 6592	Stainless steel washer M10 UNI 6592	Rondelle inox M10 UNI 6592
03100008	Dado ES inox M8 UNI 5588	Impellor fixing nut M8 UNI 5588	Écrou Hes M8 UNI 5588
05100005	Fascetta D=26-38	Jubilee clip D=26-38	Collier D=26-38
05100008	Fascetta D=68-85	Jubilee clip D=68-85	Collier D=68-85
06140003	Anello OR 113 2,62x10,78	Impellor OR ring 113 2,62x10,78	Anneau OR 113 2,62x10,78
06140010	Anello OR 4650 3,53x164,7	Impellor cover OR ring 4650 3,53x164,7	Anneau OR 4650 3,53x164,7
06150001	Tenuta meccanica 1-1,5	Mechanical seal 1-1,5	Joint étanchéité 1-1,5
06160004	Angus 32x22x5,5	Drain plug seal 32x22x5,5	Étanchéité 32x22x5,5
07130155	Tubo di scarico LG=1500x32	Drain hose LG=1500x32	Tube de vidange LG=1500x32
09100001	Cuscinetto 12x32x10 inox	s/s bearing 12x32x10	Coussinet 12x32x10 inox
09100002	Cuscinetto 15x35x11 inox	s/s bearing 15x35x11	Coussinet 15x35x11 inox



elcanto

Зип Общепит

LAVASTOVIGLIE

885-120-760-240

TAV. 10

+7(812)987-08-81

2

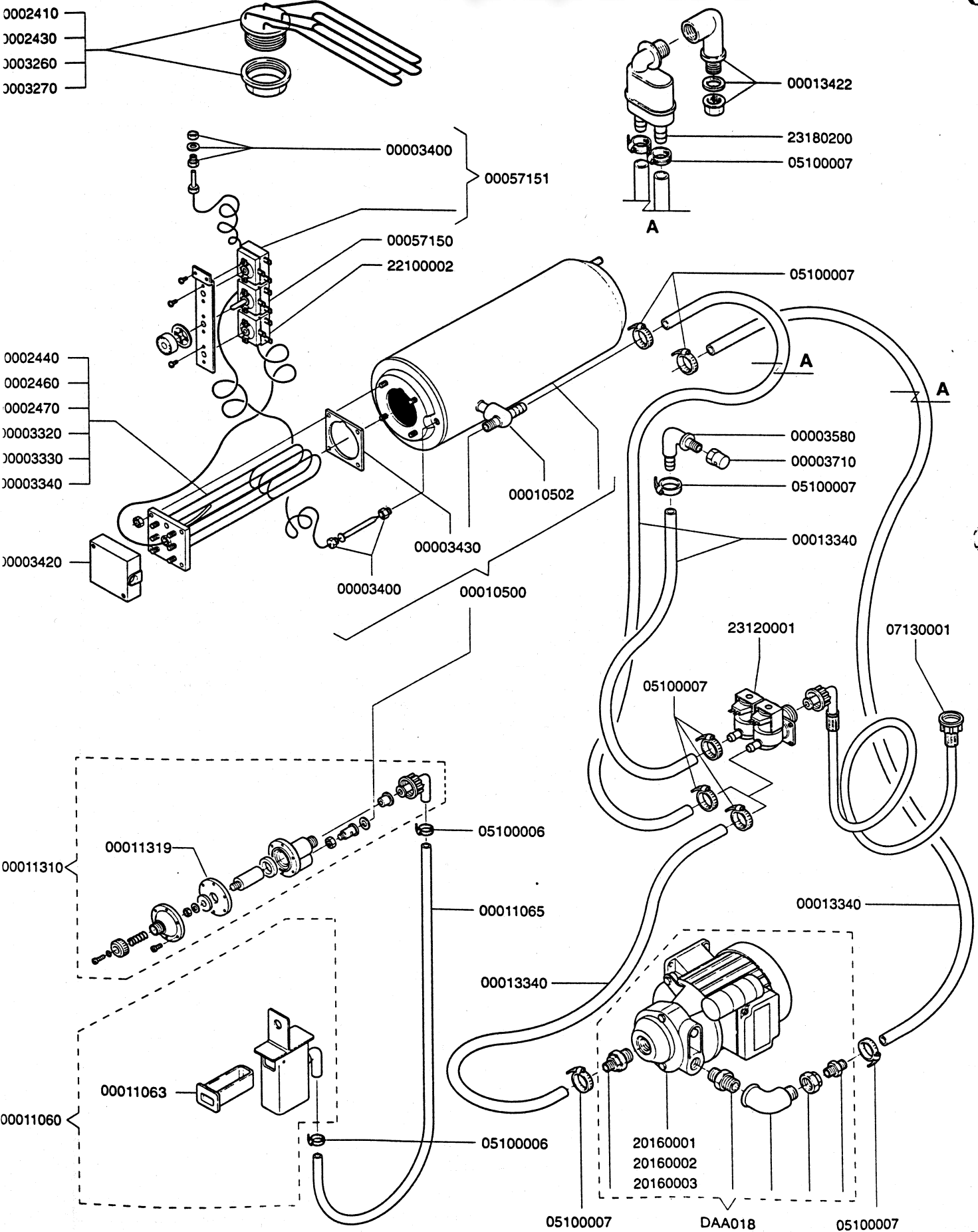



Зип Общепит

LAVASTOVIGLIE
885-129-160-240

TAV. 11

+7(812)987-08-81

000115F0
00011700
00011750
00011800

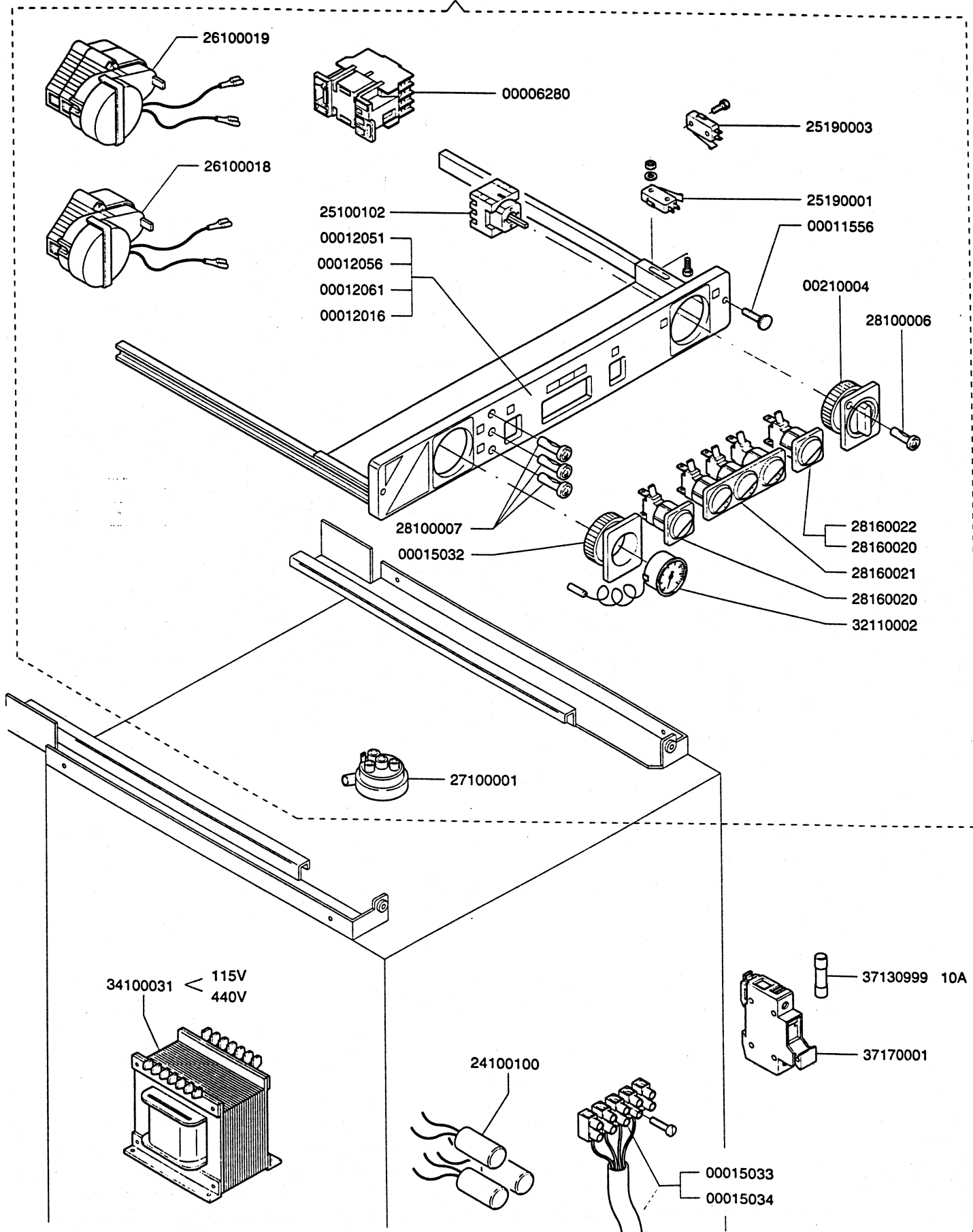



FRIGORIFERO
elcamo S.R.L.

Зип Ощепит
LAVASTOVIGLIE
885-129-160-240

TAV. 12

+7(812)987-08-81

00007000
00007020
00007040
00007060

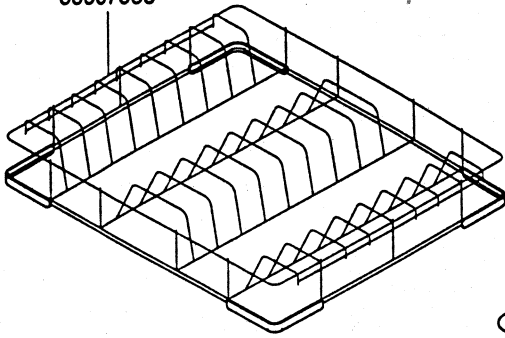

00049550

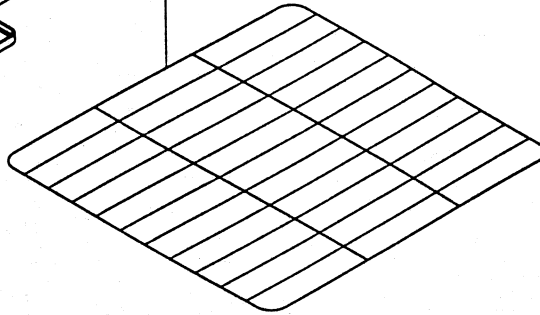

00007500
00007520
00007540

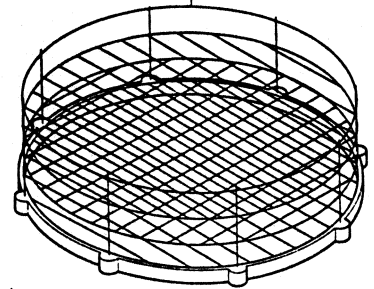

FAA020

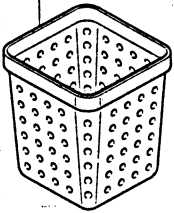

00007100
00007120
00007130
00007140

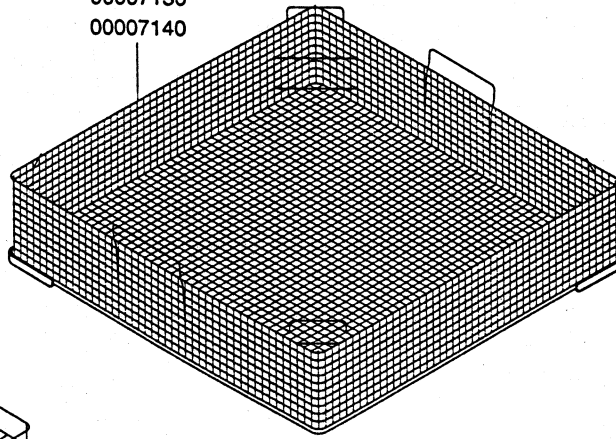

00007300
00007320
00007340

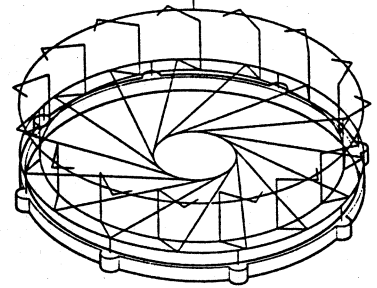

00006900
00006920
00006940

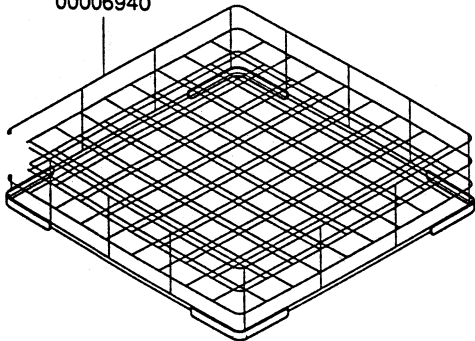

00007600
00007620
00007640

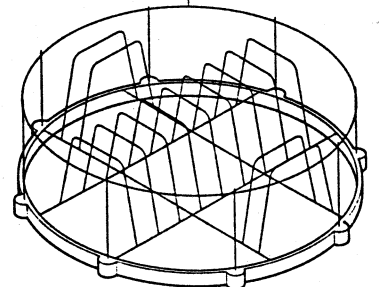

00007250



00007150
00007160
00007170
00007180

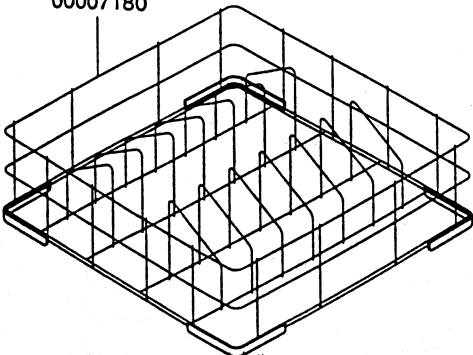

00007200

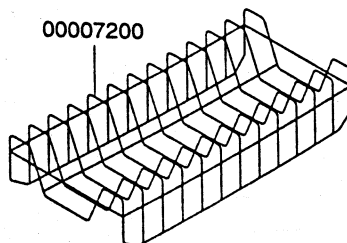

00007400
00007420
00007440

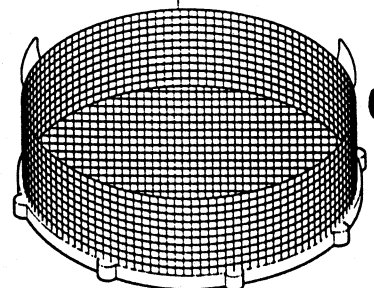



NUOVA
elframo S.M.I.

Зип Общепит
LAVASTOVIGLIE
885-160
vsezip.ru

TAV. 13

+7(812)987-08-81

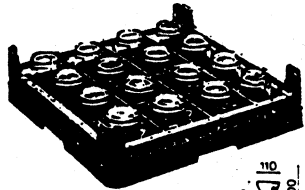

FAA029

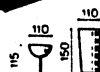
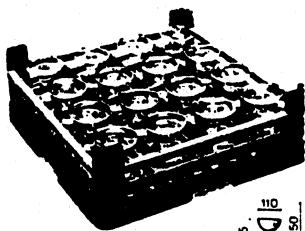

FAA009

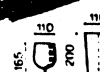
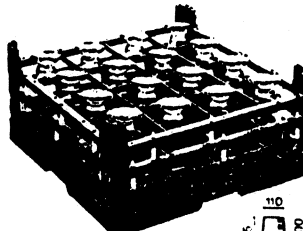

FAA010

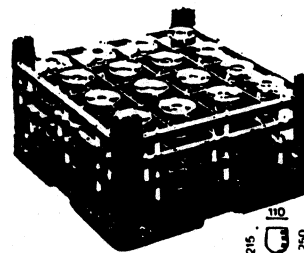

FAA011

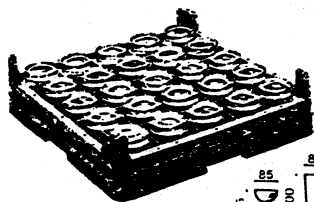

FAA012

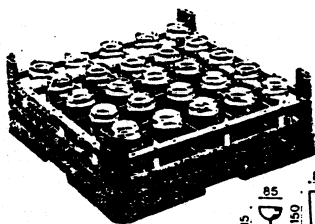

FAA013

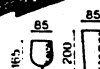
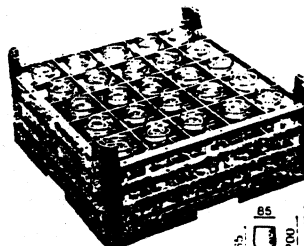

FAA014

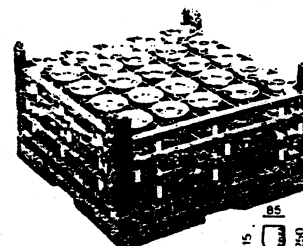

FAA015

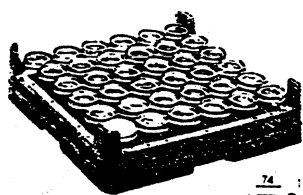

FAA016

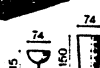
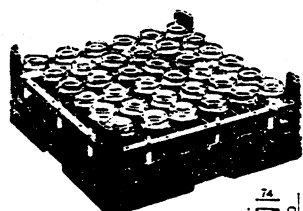

FAA017

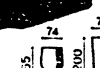
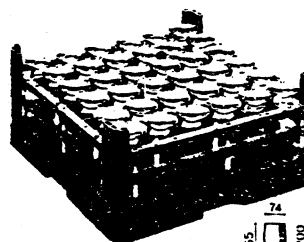

FAA018

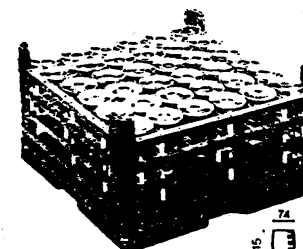

FAA019

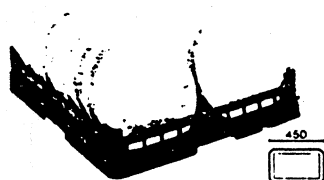

FAA006
7 vassoi - 18 piatti - 27 piattini



FAA007 16 piatti

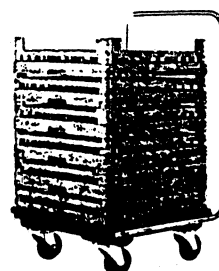

FAA050

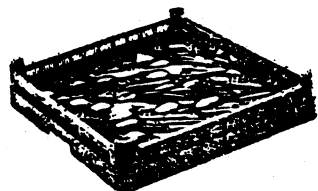

FAA021 60/80 posate

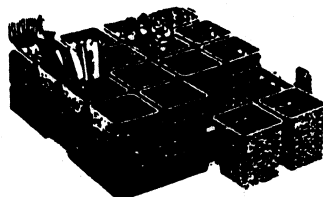

FAA024 240 posate

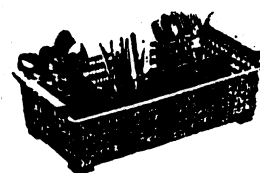

FAA027 contenitore posate

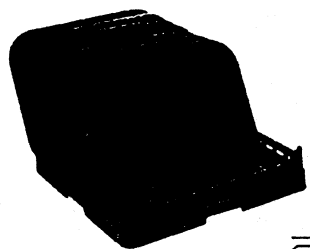

FAA022 7 vassoi

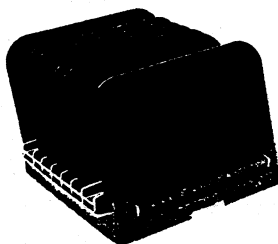

FAA028 7 vassoi



FAA025 20 tazze

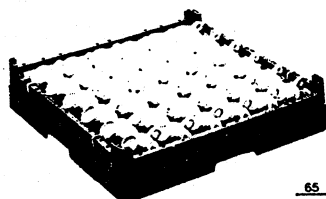

FAA026 36 tazze

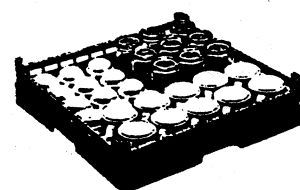

FAA001 cestello base

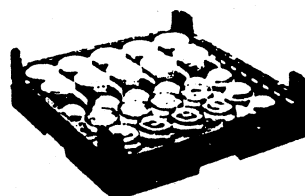

FAA002 oggetti alti mm 100

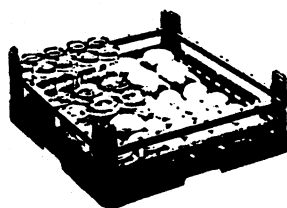

FAA003 oggetti alti mm 150

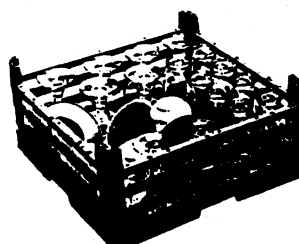

FAA004 oggetti alti mm 200

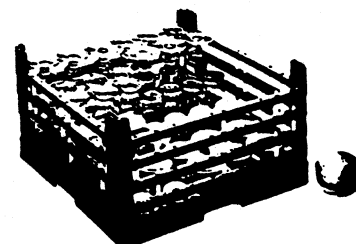

FAA005 oggetti alti mm 250

Зип Общепит

vsezip.ru

+7(812)987-08-81

9

9