

NP70-10

Зип Общени

PENTOLE A GAS ED ELETTRICHE 50 LITRI  
 GAS AND ELECTRIC HEATED BOILING PANS 50 LITERS  
 MARMITES A GAZ ET ELECTRIQUES 50 LITRES  
 GAS UND ELEKTROBEHEIZT KOCHKESSEL 50 LITERS

vsezip.ru

+7(312)987-08-81

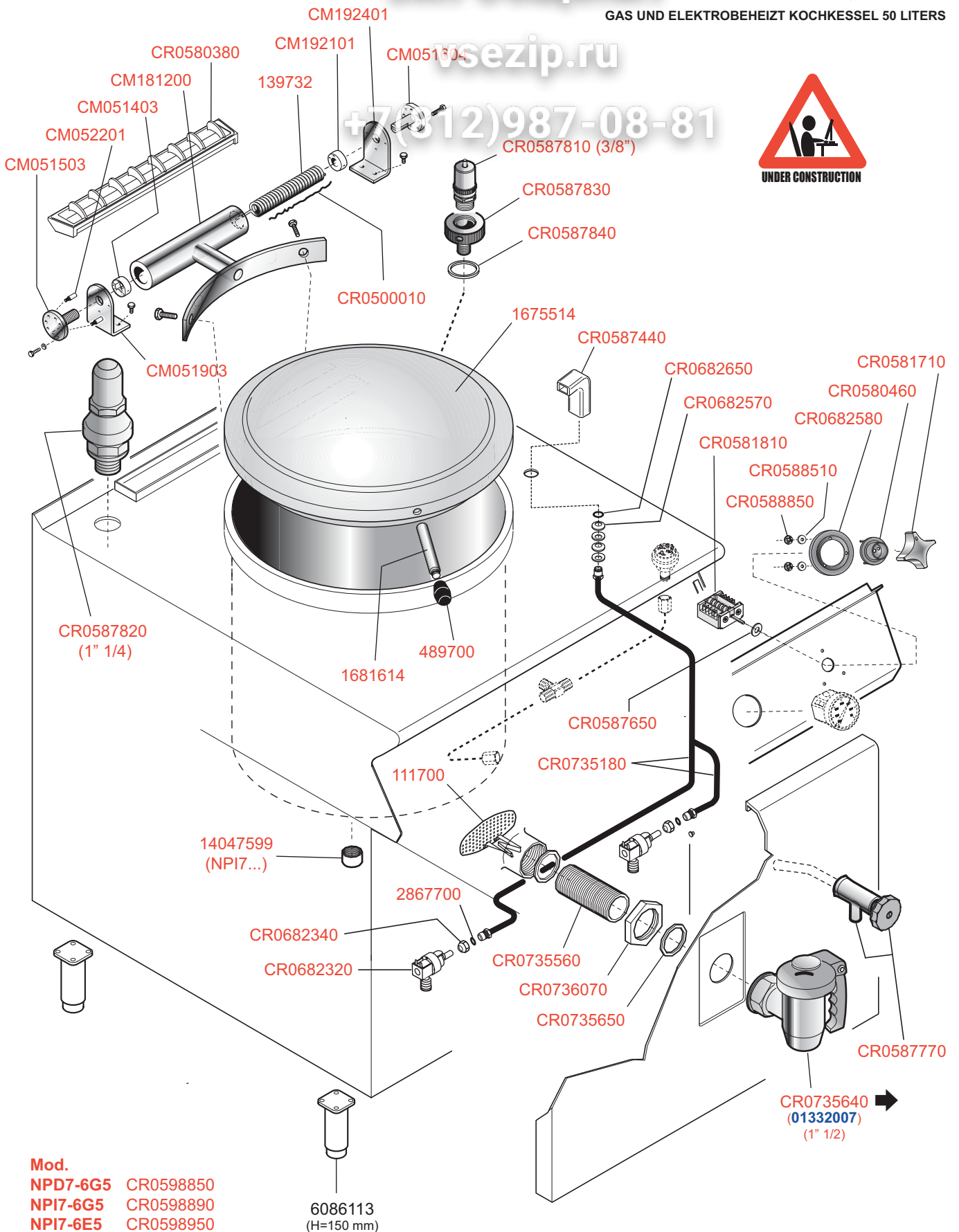

Mod.  
**NPD7-6G5** CR0598850  
**NPI7-6G5** CR0598890  
**NPI7-6E5** CR0598950

 MARENO INDUSTRIE ALI spa Mareno di Piave (TV)	ELABORATO:	APPROVATO:	GRUPPO:	DENOMINAZIONE:		
			Serie NP70	Impianto idraulico e mobile - Particolari comuni		
	DATA:	DATA:	PARTICOLARE:	REV. N.	DEL	DISEGNO N.
	21 Mar 2010	21 Mar 2010	Disegno esploso per ricambi	Z00	0310	3.P70.20/1
SOST. DIS.						

8(812)987-08-81

**A**

**1" 1/2 CON - 50 Lit.**  
**Cod. CR0735640 (01332007)**  
 (Serie N-Protagonista 70 e 90 - 2008)

- 1 Corpo cod. 22901077
- 2 Cilindro cod. 2100059
- 3 Calotta cod. 22901074
- 4 Vite fissaggio cilindro cod. 51007375
- 5 Vite di fermo rotazione cod. 31007370
- 6 Impugnatura atermica cod. 34003011
- 7 Perno fissaggio impugnatura cod. 31004854
- 8 Anello tipo RA cod. 51000209
- 9 Dado cod. 22801231
- 10 Guarnizione cod. 34012778

Serial No.  
 < MA020.....



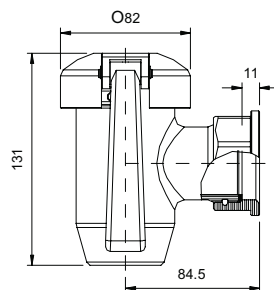

**Cod. 77122400**  
 Grasso/Grease  
 art. 36206760  
 KLUBER Non Trop  
 PLB DR  
 (Cod. art. 572411)  
 tubo da 100 g)

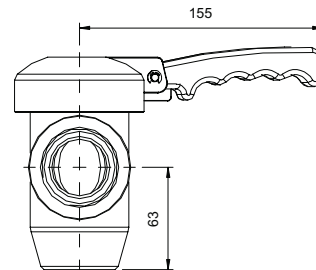

Dimens.  
mm



 MARENO INDUSTRIE ALI spa Mareno di Piave (TV)	ELABORATO:	APPROVATO:	GRUPPO:	DENOMINAZIONE:		
			Serie NP70 - 90	Rubinetto di scarico da 1" 1/2		
	DATA:	DATA:	PARTICOLARE:	REV. N.	DEL	DISEGNO N.
	16 Nov 2010	16 Nov 2010	Disegno esploso per ricambi 	Z00	1110	3.P70.20/2
SOST. DIS.						

Np70-10

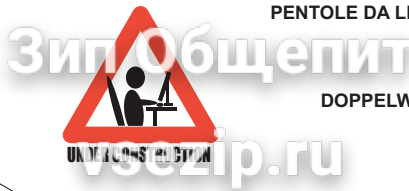

PENTOLE DA LITRI 50 - RISCALDAMENTO INDIRETTO A GAS  
 GAS HEATED (JACKETED) BOILING PANS  
 MARMITES A GAZ CHAUFFE INDIRECTE  
 DOPPELWANDIGE AUSF. - GASBEHEIZT KOCHKESSEL



Mod.

NPI76G5 CR0598890

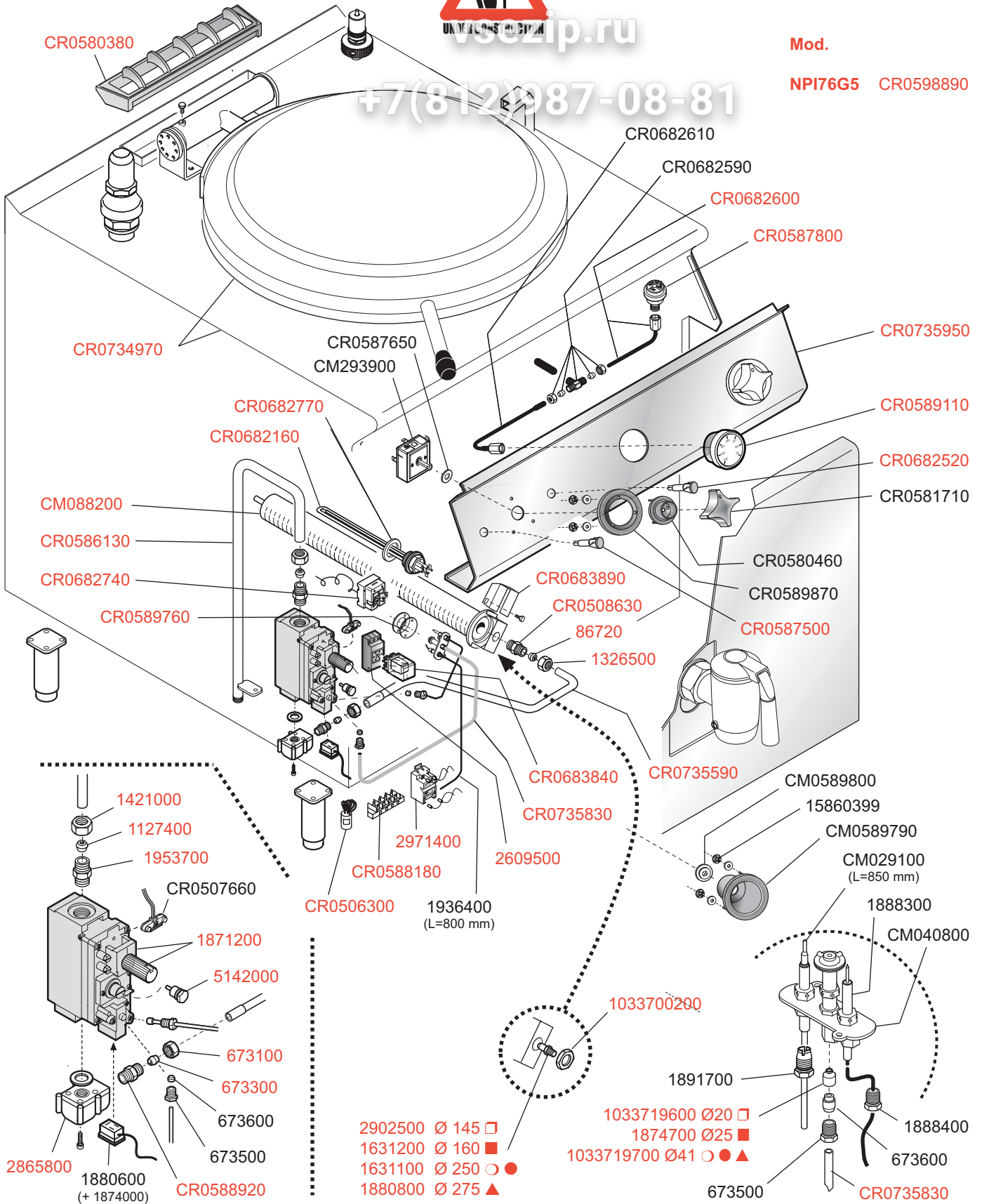
+7(812)987-08-81



□ G30/50 ■ G30/29 ○ G20/20 ● G25/25 △ G25/20 ▲ G110/8 ● G120/8 ● G140/8

 MARENO INDUSTRIE ALI spa Mareno di Piave (TV)	ELABORATO:	APPROVATO:	GRUPPO:	DENOMINAZIONE:		
			Serie NP70	Impianto gas		
	DATA:	DATA:	PARTICOLARE:	REV. N.	DEL	DISEGNO N.
	23 Mar 2010	23 Mar 2010	Disegno esploso per ricambi	▼	▼	▼
SOST. DIS.				Z00	0310	3.P70.24