



Зип Общепит

vsezip.ru

+7(812)987-08-81



GAS COMPONENTS



ELECTRIC COMPONENTS



WATER TECHNOLOGY



MECHANICAL COMPONENTS



TOOLS

Spare parts suitable for

LASA

Find the complete and up-to-date range of products in our GEV Webshop

Зип Общепит

vsezip.ru

+7(812)987-08-81

Manufacturer catalogue

The most important spare parts and accessories arranged clearly for every manufacturer



Complete product range and all appliance data always up to date in the GEV Webshop







Alphabetical Index at the end of the catalogue

GEV Webshop

www.gev-online.co.uk

www.gev-online.com



-  Add to Favourites
-  Sign In with email address and usual password
-  Easy-order – place several items in your basket at the same time
-  Quick item search – no login needed







heating elements

heating elements for pasta cookers



 <p>1</p>			
GEV No.	415020	Ref. No.	3205500+2188400
description	heating element 4500W 230V mounting \varnothing 57.5mm heating circuits 3 L 355mm W 35mm H 47mm number of thermostat sleeves 1 thermostat sleeves \varnothing 7mm length thermostat sleeves 295mm thermostat sleeve upper tube \varnothing 8.5mm hole distance 70mm hole \varnothing 10mm connection length 25mm connection male faston 6.3mm 3 hole flange immersion heater		

heating elements for salamanders/toast-

 <p>1</p>			
GEV No.	415938	Ref. No.	320803 3208030
description	heating element 1800W 230V heating circuits 1 L 330mm W 82mm H 25mm thread M10x1 mounting distance 72mm tube \varnothing 6.3mm 2 hole fixing connection length 20mm immersion heater		
accessories for	415938		
	GEV No.	510416	Ref. No. —
	flat gasket fibre ED \varnothing 19mm ID \varnothing 10.5mm thickness 1.5mm for thread M10 Qty 1 pcs		
	GEV No.	510893	Ref. No. —
	O-ring EPDM thickness 2.62mm ID \varnothing 9.92mm Qty 1 pcs		
	GEV No.	520231	Ref. No. —
	nut thread M10x1 H 6mm WS 14 zinc-coated steel Qty 1 pcs		
	GEV No.	521129	Ref. No. —
	nut thread M10 H 6mm SS WS 17 Qty 1 pcs DIN/ISO DIN 439		

immersion heating elements

3 hole flange \varnothing 47.5mm

 <p>1</p>			
GEV No.	416205	Ref. No.	3202500 4194
description	heating element 3000W 230V heating circuits 1 L 260mm W 29mm H 35mm number of thermostat sleeves 1 thermostat sleeves \varnothing 10mm length thermostat sleeves 214mm tube \varnothing 6.2mm hole distance 65mm hole \varnothing 8mm connection M4 immersion heater		
spare parts for	416205		
	GEV No.	510408	Ref. No.
	O-ring EPDM thickness 5.34mm ID \varnothing 47mm Qty 1 pcs		

Зип-Общепит

accessories for	416205		
GEV No.	510562	Ref. No.	—
	O-ring silicone thickness 5.34mm ID \varnothing 47mm Qty 1 pcs		

+7(812)987-08-81

 <p>1</p>			
GEV No.	415935	Ref. No.	103705400 320801 3208010
description	heating element 4500W 230V mounting \varnothing 47.5mm heating circuits 3 L 320mm W 34mm H 30mm number of thermostat sleeves 1 thermostat sleeves \varnothing 7mm length thermostat sleeves 300mm thermostat sleeve eccentric, clinging tube \varnothing 6.3mm hole distance 63mm hole \varnothing 10mm connection male faston 6.3mm 3 hole flange immersion heater		

spare parts for	415935		
	GEV No.	510408	Ref. No.
	O-ring EPDM thickness 5.34mm ID \varnothing 47mm Qty 1 pcs		

accessories for	415935		
	GEV No.	510562	Ref. No.
	O-ring silicone thickness 5.34mm ID \varnothing 47mm Qty 1 pcs		

accessories for	415935		
	GEV No.	510408	Ref. No.
	O-ring EPDM thickness 5.34mm ID \varnothing 47mm Qty 1 pcs		

 <p>1</p>			
GEV No.	418686	Ref. No.	3201500 3206000 320808 3208080 4306
description	heating element 6000W 230V mounting \varnothing 47.5mm heating circuits 3 L 350mm W 35mm H 40mm number of thermostat sleeves 1 thermostat sleeves \varnothing 7mm length thermostat sleeves 220mm thermostat sleeve clinging tube \varnothing 6.3mm hole distance 63mm hole \varnothing 8mm connection length 7mm connection M4 3 hole flange immersion heater		

accessories for	418686		
	GEV No.	510408	Ref. No.
	O-ring EPDM thickness 5.34mm ID \varnothing 47mm Qty 1 pcs		

	GEV No.	510562	Ref. No.
	O-ring silicone thickness 5.34mm ID \varnothing 47mm Qty 1 pcs		











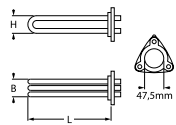

Зип-Общепит

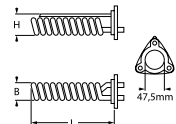

group

vsezip.ru

+7(812)987-08-81

			
			
GEV No.	418687	Ref. No.	320816 3208160
description	heating element 8800W 230V mounting ø 47.5mm heating circuits 3 L 550mm W 35mm H 40mm number of thermostat sleeves 1 thermostat sleeves ø 7mm length thermostat sleeves 235mm thermostat sleeve clinging tube ø 6.3mm hole distance 63mm hole ø 8mm connection length 7mm connection M4 3 hole flange immersion heater		
accessories for	418687		
	GEV No.	510408	Ref. No.
			218800 2188000 218840 2188400
	O-ring EPDM thickness 5.34mm ID ø 47mm Qty 1 pcs		
	GEV No.	510562	Ref. No.
			—
	O-ring silicone thickness 5.34mm ID ø 47mm Qty 1 pcs		

			
			
GEV No.	417165	Ref. No.	320700 3207000
description	heating element 2470/2940W 220/240V mounting ø 47.5mm heating circuits 1 L 196mm W 35mm H 45mm number of thermostat sleeves 1 thermostat sleeves ø 9mm length thermostat sleeves 170mm thermostat sleeve upper tube ø 6.4mm hole distance 63mm connection length 23mm connection M4 immersion heater		
accessories for	417165		
	GEV No.	510408	Ref. No.
			218800 2188000 218840 2188400
	O-ring EPDM thickness 5.34mm ID ø 47mm Qty 1 pcs		
	GEV No.	510562	Ref. No.
			—
	O-ring silicone thickness 5.34mm ID ø 47mm Qty 1 pcs		
	GEV No.	521103	Ref. No.
			—
	nut thread M4 H 3mm WS 7 brass Qty 20 pcs		
	GEV No.	521104	Ref. No.
			—
	washer ID ø 4.3mm ED ø 8mm thickness 0.5mm brass Qty 20 pcs for thread M4		
	GEV No.	560111	Ref. No.
			—
	plain washer ID ø 4.3mm ED ø 9mm thickness 0.8mm SS Qty 20 pcs DIN 125A for thread M4		
	GEV No.	560131	Ref. No.
			—
	hexagonal nut thread M4 H 3.2mm WS 7 SS DIN/ISO DIN 934 / ISO 4032/8673 Qty 20 pcs		

			
GEV No.	418636	Ref. No.	320809 3208090
description	heating element 4500W 230V mounting ø 47.5mm heating circuits 3 L 290mm W 28mm H 45mm H1 25mm H2 20mm tube ø 6mm hole distance 62mm hole ø 8x10mm 3 hole flange immersion heater		
spare parts for	418636		
	GEV No.	510408	Ref. No.
			218800 2188000 218840 2188400
	O-ring EPDM thickness 5.34mm ID ø 47mm Qty 1 pcs		
	GEV No.	521030	Ref. No.
			—
	O-ring Viton thickness 5.34mm ID ø 47mm Qty 1 pcs		

3 hole flange ø57.5mm

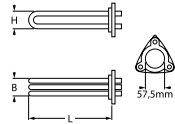
			
			
GEV No.	415934	Ref. No.	320804 3208040
description	heating element 3500W 230V mounting ø 57.5mm heating circuits 3 L 192mm W 38mm H 50mm number of thermostat sleeves 1 thermostat sleeves ø 7.5mm length thermostat sleeves 180mm thermostat sleeve eccentric, clinging tube ø 8.5mm hole distance 72mm hole ø 8mm connection male faston 6.3mm 3 hole flange immersion heater		

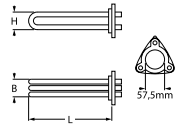
			
			
GEV No.	415020	Ref. No.	3205500+2188400
description	heating element 4500W 230V mounting ø 57.5mm heating circuits 3 L 355mm W 35mm H 47mm number of thermostat sleeves 1 thermostat sleeves ø 7mm length thermostat sleeves 295mm thermostat sleeve upper tube ø 8.5mm hole distance 70mm hole ø 10mm connection length 25mm connection male faston 6.3mm 3 hole flange immersion heater		



Зип Общепит
accessories

vsezip.ru
O-rings

+7(812)987-08-81



GEV No.	415021	Ref. No.	320802 3208020
description	heating element 6000W 230V mounting ϕ 57.5mm heating circuits 3 L 343mm W 37mm H 50mm number of thermostat sleeves 1 thermostat sleeves ϕ 7mm length thermostat sleeves 294mm thermostat sleeve not clinging tube ϕ 8.5mm hole distance 72mm hole ϕ 8mm connection M5 3 hole flange		
spare parts for	415021		
	GEV No.	510409	Ref. No. 218845 2188450
accessories for	415021		
	GEV No.	550002	Ref. No. —
description	tension strap H 10mm L 21mm W 10mm hole ϕ 6.5mm for heating element		



GEV No.	415937	Ref. No.	320805 3208050
description	heating element 9000W 230V mounting ϕ 57.5mm heating circuits 3 L 340mm W 37mm H 52mm number of thermostat sleeves 1 thermostat sleeves ϕ 7mm length thermostat sleeves 300mm thermostat sleeve clinging tube ϕ 8.5mm hole distance 72mm hole ϕ 8mm connection M5 3 hole flange immersion heater		
spare parts for	415937		
	GEV No.	510409	Ref. No. 218845 2188450
description	O-ring EPDM thickness 5.34mm ID ϕ 56.52mm Qty 1 pcs		

with compression flange 62 x 26mm

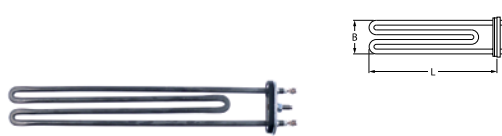

GEV No.	415266	Ref. No.	10714
description	heating element 2000W 230V heating circuits 1 compression flange flange 62x26mm L 300mm W 41mm Hmm connection male faston 6.3mm tube ϕ 6.3mm immersion heater		

sealing washers



GEV No.	510408	Ref. No.	218800 2188000 218840 2188400
description	O-ring EPDM thickness 5.34mm ID ϕ 47mm Qty 1 pcs		

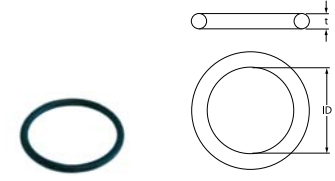

GEV No.	510409	Ref. No.	218845 2188450
description	O-ring EPDM thickness 5.34mm ID ϕ 56.52mm Qty 1 pcs		

thermostats

bi-metal thermostats

bi-metal thermostats



GEV No.	390232	Ref. No.	326722 3267220
description	bi-metal thermostat switch-off temp. 55°C 1-pole		

electric components



control and safety thermostats

Зип-Общепит

EGO

control thermostats

55.10/19_series

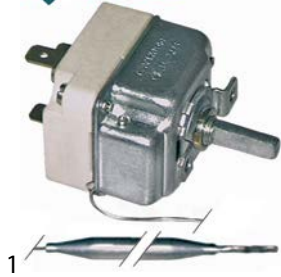

GEV No.	375211	Ref. No.	326732 3267320
----------------	--------	-----------------	-------------------

description thermostat t.max. 85°C temperature range 30-85°C 1-pole 1CO 16A probe ø 6mm probe L 130mm capillary pipe 900mm capillary pipe isolated 900mm gland nut shaft L 23mm shaft position upper rotation 270° probe material SS

55.34_series

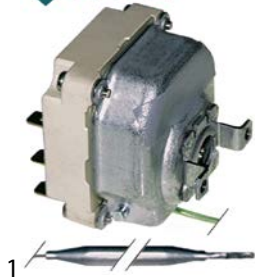

GEV No.	375210	Ref. No.	326724 3267240
----------------	--------	-----------------	-------------------

description thermostat t.max. 90°C temperature range 38-90°C 3-pole 3CO 16A probe ø 6mm probe L 215mm capillary pipe 900mm capillary pipe isolated 900mm gland nut shaft Lmm rotation 270°

safety thermostats

55.32_series

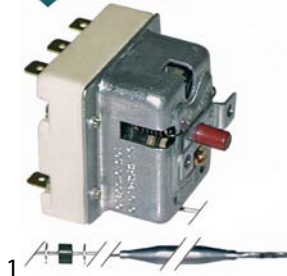

GEV No.	375209	Ref. No.	326726 3267260
----------------	--------	-----------------	-------------------

description safety thermostat switch-off temp. 140°C 3-pole 20A probe ø 6mm probe L 89mm capillary pipe 900mm capillary pipe isolated 900mm gland nut probe SS

control thermostats

vsezip.ru

+7(812)987-08-81



GEV No.	390006	Ref. No.	326400 3264000
----------------	--------	-----------------	-------------------

description thermostat t.max. 86°C temperature range 0-86°C 1-pole 1CO 16A probe ø 6.5mm probe L 95mm capillary pipe 1500mm capillary pipe isolatedmm gland nut shaft ø 6x4.6mm shaft L 19mm rotation 270°

accessories for 390006

GEV No.	110100	Ref. No.	—
----------------	--------	-----------------	---

knob thermostat t.max. 90°C 0-90°C ø 42mm shaft ø 6x4.6mm shaft flat -135° black



GEV No.	110105	Ref. No.	—
----------------	--------	-----------------	---

rosette knob ø 42mm ø 56mm zero mark

safety thermostats



GEV No.	390601	Ref. No.	326710 3267100
----------------	--------	-----------------	-------------------

description safety thermostat switch-off temp. 120°C 1-pole 16A probe ø 6.5mm probe L 93mm capillary pipe 1500mm capillary pipe isolated 1440mm gland nut probe

accessories

gland nut accessories

locking screws



GEV No.	550913	Ref. No.	241729 2417290
----------------	--------	-----------------	-------------------

description union screw thread M12x1 probe ø max. 6mm WS 12 brass





Зип Общепит

vsezip.ru

(812)987-08-81

plunger sockets

			
1			
GEV No.	541519	Ref. No.	241738 2417380
description	thermowell IT M10x1 ET M14x1.5 L 33mm brass single ø 10.5mm		
accessories for	541519		
	GEV No.	521101	Ref. No. —
nut thread M14x1.5 H 5mm WS 19 SS Qty 1 pcs			

microswitches

			
1			
GEV No.	345254	Ref. No.	312103 3121030
description	microswitch with lever 250V 16A 1CO connection male faston 6.3mm ambient temperature max. 120°C mounting distance 22mm actuating force: 60g lever length 58mm		



switches and momentary switches



rocker/momentary rocker switches

30x22mm			
			
1			
GEV No.	347704	Ref. No.	316720 3167200
description	momentary rocker switch mounting measurements 30x22mm red 2CO 250V 16A illuminated connection male faston 6.3mm ambient temperature max. 100/55°C protection IP40		

pin-plunger actuated

M10			
			
1			
GEV No.	345032	Ref. No.	3121000 3276
description	microswitch with plunger thread M10x1 thread L 12mm 250V 16A 1CO connection male faston 6.3mm stroke 7mm mounting distance 22mm L 28mm ambient temperature max. 125°C type SP9603 actuating force: 180g		

			
1			
GEV No.	346978	Ref. No.	316560 3165600
description	momentary rocker switch mounting measurements 30x22mm black 2CO 250V 16A connection male faston 6.3mm ambient temperature max. 125/55°C protection IP40		
accessories for	346978		
	GEV No.	301036	Ref. No. —
protective cover internal size 30x22mm for rocker switch mounting measurementsmm			

M12			
			
1			
GEV No.	345350	Ref. No.	3121010
description	microswitch with plunger mounting distance 22mm thread M12x0.75 thread L 16mm 250V 16A 1CO connection male faston 6.3mm stroke 4mm ambient temperature max. 125°C type EF83161.3 actuating force: 66g		
accessories for	345350		
	GEV No.	345351	Ref. No. —
nut thread M12x0.75 H 1.6mm WS 14 chrome-plated brass Qty 1 pcs			

push/momentary push switches

ø25mm			
			
1			
GEV No.	346936	Ref. No.	316824 3168240
description	momentary push switch mounting ø 25mm green 1NO/indicator light 250V 16A connection male faston 6.3mm ambient temperature max. 85°C protection IP40		

position switches

SIEMENS			
3SE2 series			
position switches (complete)			
			
1			
GEV No.	346935	Ref. No.	316820 3168200
description	microswitch 1NO/1NC		

1 electric components

Зип-Общепит
magnetic switches

cam switches

3 operating positions



1

GEV No.	300086	Ref. No.	316812 3168120
description	cam switch 3 operating positions programme sequence 1-0-2 shaft \varnothing 6x4.6mm connection male faston 10-pole		

rotary switches

TECNOMATIC



1

GEV No.	346034	Ref. No.	316810 3168100
description	rotary switch 2 0-1 sets of contacts 4 type HD12X275R000 600V 12A shaft \varnothing 6x4.6mm shaft L 40mm shaft round connection male faston 6.3mm		



1

GEV No.	300366	Ref. No.	316818 3168180
description	rotary switch 3 0-1-2 sets of contacts 3 type HD12X312AR000 600V 12A shaft \varnothing 5x5mm shaft L 23mm shaft square connection male faston 6.3mm		



1

GEV No.	300365	Ref. No.	316819 3168190
description	rotary switch 4 0-1-2-3 sets of contacts 4 type HD12X274R000 600V 12A shaft \varnothing 5x5mm shaft L 22mm shaft square connection male faston 6.3mm		

36x13mm

vsezip.ru

+7(812)987-08-81



1

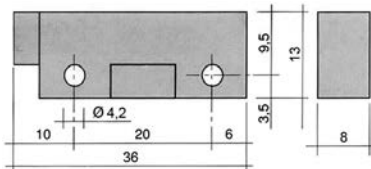

GEV No.	345792 ¹	Ref. No.	312104 3121040 312106 3121060
description	magnetic switch L 36mm W 13mm 1NO 250V 0.04A P max. 10W connection cable length 2500mm mounting distance 20mm		

¹with coded connector

accessories

magnets



1

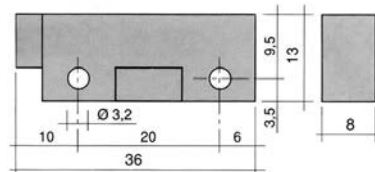

GEV No.	345398	Ref. No.	312105 3121050
description	magnet \varnothing mm L 36mm H 8mm W 13mm hole distance 20mm M3 hole \varnothing 3mm		

lamps

indicator lights

indicator lights 2-piece (lens and indicator lamp)

indicator light lenses

 \varnothing 12mm (type SDY-3)

1

GEV No.	359262	Ref. No.	310906 3109060
description	indicator light housings mounting measurements \varnothing 12mm green round Qty 1 pcs		



Зип-Общепит

vsezip.ru

(812)987-08-81

indicator lamps for socket type SRZ / SDK / SDY / SFK

 <p>1</p>			
GEV No.	359132	Ref. No.	3109030 310905 3109050
description	indicator lamp green 250V connection male faston 6.3mm protection IP54 ambient temperature max. 85°C		

accessories for	360040		
GEV No.	110197	Ref. No.	—
description	knob switch zero mark ø 42mm shaft ø 6x4.6mm shaft flat adjustable black		

timers



programme timers

 <p>1</p>			
GEV No.	360397	Ref. No.	340609 3406090 (old version)
description	timer BIGATTI engines 2 chambers 5 operation time 60s up to 3min 230V manuf. no. LA007 / 3406090 motor type UDS40NE1RK		

 <p>1</p>			
GEV No.	360395	Ref. No.	3406031
description	timer FIBER P25 engines 1 chambers 4 operation time 180s 230V shaft ø 6x4.6mm shaft L 40mm manuf. no. P255J04H5J6 motor type M51BJ0R6400 for devices with mechanical dosing pump edition since year of construction 2000		

 <p>1</p>			
GEV No.	360687	Ref. No.	3406090
description	timer CDC 4905DV engines 2 chambers 5 operation time 60s up to 3min 230V		

 <p>1</p>			
GEV No.	360120	Ref. No.	3406030
description	timer FIBER P25 engines 1 chambers 5 operation time 180s 230V shaft ø 6x4.6mm shaft L 40mm manuf. no. P255J05H542 motor type M51BJ0R6400 for devices with electric dosing pump edition until year of construction 2000		

 <p>1</p>				
GEV No.	360040	Ref. No.	3324 340200 3402000 4188	
description	timer CDC 9003F engines 1 chambers 3 operation time 6min 230V shaft ø 6x4.6mm shaft L 21mm manuf. no. 9003F3 / PRCIH5 motor type M48R ATS			
For models:	LB925H, LS3-A			
spare parts for	360040			
	GEV No.	360118	Ref. No.	—
	motor CDC pinion ø 4.9mm teeth 10 230V voltage AC 50/60Hz turn direction right motor ø 47mm H 19.3mm motor type M48R ATS for timer cable length 260mm 1.9/2.5W			

GEV No.	360120	Ref. No.	3406030	
description	timer FIBER P25 engines 1 chambers 5 operation time 180s 230V shaft ø 6x4.6mm shaft L 40mm manuf. no. P255J05H542 motor type M51BJ0R6400 for devices with electric dosing pump edition until year of construction 2000			
spare parts for	360120			
	GEV No.	360673	Ref. No.	—
	motor kit pinion ø 6.8mm teeth 15 230V voltage AC 50/60Hz turn direction clockwise motor ø 48mm H 18.5mm motor type UDS-40NE1RNZ165 cable length 150mm with holder			

 <p>1</p>			
GEV No.	360398	Ref. No.	3406051
description	timer FIBER P25 engines 2 chambers 7 operation time 12s / 2min 230V shaft ø 6mm shaft L 40mm manuf. no. P255J07JGJ7 motor type M51BJ0R6400 / M51BJ0L6400		

1 electric components



Зип Общепит

vsezip.ru

+7(812)987-08-81



1

GEV No.	360122	Ref. No.	340605 3406050
description	timer FIBER P25 engines 2 chambers 8 operation time 12s / 2min 230V shaft ømm shaft Lmm manif. no. P255J08JG75 motor type M51BJ0R6400 / M51BJ0L6400		
spare parts for	360122		
	GEV No.	360673	Ref. No. —
	motor kit pinion ø 6.8mm teeth 15 230V voltage AC 50/60Hz turn direction clockwise motor ø 48mm H 18.5mm motor type UDS-40NE1RNZ165 cable length 150mm with holder		
	GEV No.	360674	Ref. No. —
	motor kit pinion ø 6.8mm teeth 15 230V voltage AC 50/60Hz turn direction counterclockwise motor ø 48mm H 18.5mm motor type UDS40NE1RNZ165 cable length 150mm with holder		



1

GEV No.	360396	Ref. No.	340607 3406070
description	timer FIBER P26 engines 1 chambers 5 operation time 18min 230V shaft ømm shaft Lmm manif. no. P265J05J9017 motor type M61B40L6400		





1

GEV No.	360076	Ref. No.	512069300
description	timer FIBER P37 engines 1 chambers 3 operation time 180s 230V shaft ø 6x4.6mm shaft L 18mm manif. no. P375J03H524 motor type M51BJ0R6400		



1

GEV No.	360121	Ref. No.	340604 3406040
description	timer FIBER P25 engines 2 chambers 8 operation time 40s / 120s 230V shaft ømm shaft Lmm manif. no. P255J08JH76 motor type M51BJ0R6400 / M51BJ0L6400		
spare parts for	360121		
	GEV No.	360673	Ref. No. —
	motor kit pinion ø 6.8mm teeth 15 230V voltage AC 50/60Hz turn direction clockwise motor ø 48mm H 18.5mm motor type UDS-40NE1RNZ165 cable length 150mm with holder		
	GEV No.	360674	Ref. No. —
	motor kit pinion ø 6.8mm teeth 15 230V voltage AC 50/60Hz turn direction counterclockwise motor ø 48mm H 18.5mm motor type UDS40NE1RNZ165 cable length 150mm with holder		



1

GEV No.	360406	Ref. No.	340400 3404000
description	timer FIBER P26 engines 1 chambers 4 operation time 18min 230V shaft ømm shaft Lmm manif. no. P265J04J907 motor type M61B40R6400		

contactors

SIEMENS

power contactors



1

GEV No.	380848	Ref. No.	342623 3426230
description	power contactor resistive load 20A 230VAC (AC3/400V) 8.4A/4kW main contacts 3NO connection screw connection type 3TF30000-0A		
accessories for	380848		
	GEV No.	380849	Ref. No. 342624 3426240
	contact block contacts 1NO/1NC		



Зип Обществит

vsezip.ru

+7(812)987-08-81

auxiliary contacts



1			
GEV No.	380849	Ref. No.	342624 3426240
description	contact block contacts 1NO/1NC		

overload switches



1			
GEV No.	380850	Ref. No.	342625 3426250
description	overload switch setting range 3.2-5A type 3UA50 00-1F		

relays

power relays

with DIN rail mounting

upper





1			
GEV No.	380183	Ref. No.	342626 3426260
description	power relays FINDER 230VAC 12A 2CO connection male faston 4.8mm DIN rail manif. no. 56.32.8.230.0007		
accessories for	380183		
	GEV No.	Ref. No.	—
	380476		
	relay socket dimensions 78x27x33.5mm 250V voltage AC 10A FINDER manif. no. 96.72		

solenoid valves (water)

ELBI

straight



1			
GEV No.	373021	Ref. No.	330050 3300500
description	solenoid valve double straight 230VAC inlet 3/4" outlet 11.5mm output 1x 4.7l/min DN10 ELBI		
spare parts for	373021		
	GEV No.	Ref. No.	—
	370467		
	solenoid valve filter suitable for ELBI		
	GEV No.	Ref. No.	—
	371263		
	reducer ELBI type EATON (INVENSYS) flow rate 4.7l/min pressure range 0 up to 10bar tolerance ±15/25% grey		



1			
GEV No.	373025	Ref. No.	330500 3305000 4165
description	solenoid valve triple straight 230VAC inlet 3/4" outlet 11.5mm DN10 ELBI		
spare parts for	373025		
	GEV No.	Ref. No.	—
	370467		
	solenoid valve filter suitable for ELBI		

spare parts and accessories

reducers

outlet side



















1			
GEV No.	371260	Ref. No.	330650 3306500
description	reducer type ELBI flow rate 0.5l/min pressure range 0 up to 10bar tolerance ±15/25% red		





Зип-Общепит

vsezip.ru

+7(812)987-08-81

TP			
			
GEV No.	370015	Ref. No.	330100 3301000 330651 3306510
description	solenoid valve single angled 230VAC inlet 3/4" outlet 11.5mm DN10 TP		
accessories for	370015		
	GEV No.	371220	Ref. No. —
reducer TP flow rate 3l/min red tolerance ±15%			
	GEV No.	371221	Ref. No. —
reducer TP flow rate 5.5l/min yellow tolerance ±15%			
	GEV No.	371222	Ref. No. —
reducer TP flow rate 6l/min grey tolerance ±15%			
	GEV No.	371223	Ref. No. —
reducer TP flow rate 10l/min white tolerance ±15%			
	GEV No.	371224	Ref. No. —
reducer TP flow rate 12l/min bronze tolerance ±15%			
	GEV No.	371225	Ref. No. —
reducer TP flow rate 16l/min light brown tolerance ±15%			
	GEV No.	371226	Ref. No. —
reducer TP flow rate 20l/min red tolerance ±15%			
	GEV No.	371230	Ref. No. —
reducer TP flow rate 0.25l/min red tolerance ±25%			
	GEV No.	371231	Ref. No. —
reducer TP flow rate 0.35l/min violet tolerance ±25%			
	GEV No.	371232	Ref. No. —
reducer TP flow rate 0.5l/min orange tolerance ±25%			
	GEV No.	371233	Ref. No. —
reducer TP flow rate 0.8l/min white tolerance ±25%			
	GEV No.	371234	Ref. No. —
reducer TP flow rate 1l/min light blue tolerance ±25%			
	GEV No.	371235	Ref. No. —
reducer TP flow rate 1.2l/min brown tolerance ±25%			
	GEV No.	371236	Ref. No. —
reducer TP flow rate 1.5l/min light brown tolerance ±25%			
	GEV No.	371237	Ref. No. —
reducer TP flow rate 2.5l/min yellow tolerance ±25%			

accessories for 370015			
	GEV No.	371238	Ref. No. —
reducer TP flow rate 3.4l/min dark green tolerance ±25%			
	GEV No.	371239	Ref. No. —
reducer TP flow rate 5l/min black tolerance ±25%			
	GEV No.	371240	Ref. No. —
reducer TP flow rate 8l/min blue tolerance ±20%			

metal

ASCO

spare parts and accessories

O-rings

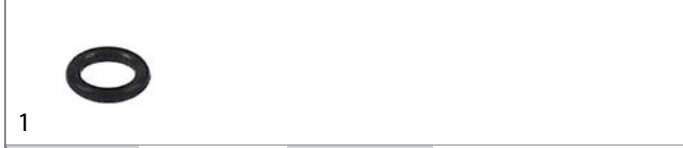

GEV No.	371095	Ref. No.	2182100
description	O-ring Viton thickness 1.78mm ID ø 6.07mm Qty 1 pcs		

Solenoid valve - accessories

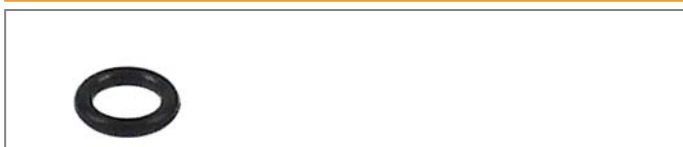

GEV No.	371095	Ref. No.	2182100
description	O-ring Viton thickness 1.78mm ID ø 6.07mm Qty 1 pcs		

pressure switches

for warewashing

ø 58mm with male faston 6.3mm

with connection horizontal

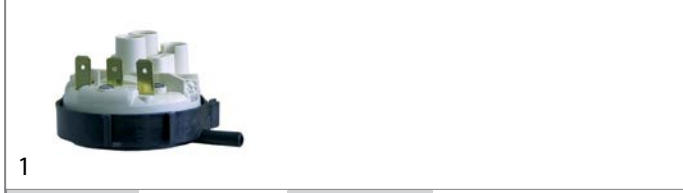

GEV No.	541047	Ref. No.	328303 3283030
description	pressure control pressure range 340/200mbar connection 6mm ø 58mm pressure connection horizontal warewashing		





Зип Общежит

accessories

vsezip.ru

7(812)987-08-81

			
1			
GEV No.	541046	Ref. No.	328301 3283010
description	pressure control pressure range 45/20mbar connection 6mm ø 58mm pressure connection horizontal warewashing		

			
1			
GEV No.	541140	Ref. No.	3281100 37610054
description	pressure control pressure range 55/30mbar connection 6mm ø 58mm pressure connection horizontal warewashing		

with connection vertical			
			
1			
GEV No.	541520	Ref. No.	328100 3281000 3609
description	pressure control pressure range 55/30mbar connection male faston 6.3mm ø 55mm pressure connection vertical warewashing pressure connection ø 6mm		

miscellaneous			
			
1			
GEV No.	541038	Ref. No.	328302 3283020
description	pressure control double		

			
1			
GEV No.	541109	Ref. No.	260032 2600320
description	Y-piece plastic hose ø 8-6-8mm for pressure switch		

pumps

wash and rinse pumps

FIR			
pumps			
			
1			
GEV No.	500465	Ref. No.	351890 3518900
description	pump inlet ø 28mm outlet ø 26mm type 2213.1601 230V 50Hz 1 phase 0.11kW 0.15HP L 195mm rotation direction left capacitor 5µF FIR		
spare parts for	500465		
	GEV No.	365017	Ref. No. 334600 3346000
	operating capacitor capacity 5µF 450V tolerance 5% 50/60Hz ambient temperature max. -25 to +85°C ø 28mm L 54mm M8 plastic connection male faston 6.3mm 16.10.08 protection		
	GEV No.	510384	Ref. No. —
	pump cover inlet ø 28mm outlet ø 26mm ø 100mm ID ø 76mm		
	GEV No.	510695	Ref. No. —
	mechanical shaft seal height counter ring 5.5mm ID ø 11mm		
	GEV No.	511711	Ref. No. —
	O-ring EPDM thickness 3.53mm ID ø 78.97mm Qty 1 pcs		
	GEV No.	521266	Ref. No. —
	impellor ø 67mm H 18mm thread M7 shaft ø 11mm shaft length 32mm blades 3		











Зип-Общепит

vsezip.ru +7(812)987-08-81





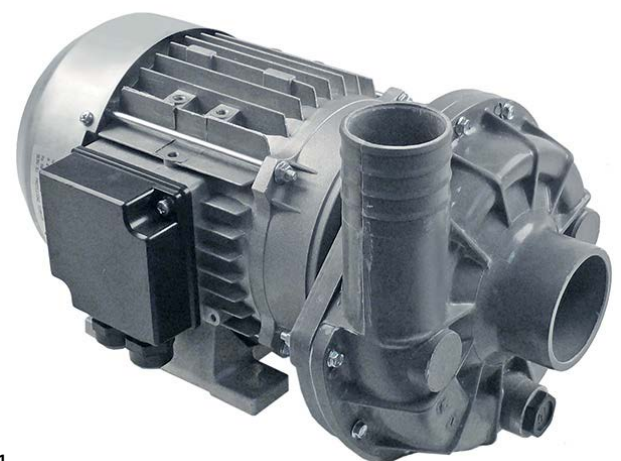

1

GEV No.	500028	Ref. No.	351890 old version 3518900 old version
description	pump inlet \varnothing 28mm outlet \varnothing 26mm type 2213.1912 230V 50Hz 1 phase 0.11kW 0.15HP L 195mm rotation direction left capacitor 6.3 μ F FIR		
spare parts for	500028		
	GEV No.	365012	Ref. No. —
	operating capacitor capacity 6.3 μ F 450V tolerance 5% 50Hz ambient temperature max. -25 to +85°C \varnothing 30mm L 61mm M8 plastic connection male faston 6.3mm protection		
	GEV No.	510384	Ref. No. —
	pump cover inlet \varnothing 28mm outlet \varnothing 26mm \varnothing 100mm ID \varnothing 76mm		
	GEV No.	510532	Ref. No. —
	impellor \varnothing 72mm H 22mm shaft \varnothing 11mm shaft length 32mm blades 3		
	GEV No.	510695	Ref. No. —
	mechanical shaft seal height counter ring 5.5mm ID \varnothing 11mm		
	GEV No.	521703	Ref. No. —
	pump cover gasket EPDM thickness 2.5mm ID \varnothing 75mm Qty 1 pcs		

	GEV No.	510508	Ref. No.	—
	pump cover FIR inlet \varnothing 45mm outlet \varnothing 40mm pump type PU 0.5/3911 turn direction right \varnothing 160mm ID \varnothing 125mm inner height 25mm			
	GEV No.	510610	Ref. No.	—
	impellor \varnothing 95.5mm H 23mm shaft intake \varnothing 9/8mm rotation direction right seat \varnothing 13mm blades 6			
	GEV No.	510692	Ref. No.	—
	mechanical shaft seal for shaft \varnothing 11mm slide ring ext. \varnothing 24mm slide ring H 13mm counter ring mounting \varnothing 26mm height counter ring 8mm counter ring int. \varnothing 14mm			
	GEV No.	521702	Ref. No.	—
	pump cover gasket thickness 3.5x4.5mm Qty 1 pcs			



1

GEV No.	500023	Ref. No.	351936 3519360
description	pump inlet \varnothing 63mm outlet \varnothing 47mm type 1225.2725 230/400V 50Hz 3 phase 1.1kW 1.5HP L 335mm rotation direction right FIR		
spare parts for	500023		
	GEV No.	510602	Ref. No. —
	impellor \varnothing 110mm H 34mm rotation direction right thread M8L shaft \varnothing 28mm seat \varnothing 12.2mm blades 6		
	GEV No.	510693	Ref. No. —
	mechanical shaft seal for shaft \varnothing 12mm slide ring ext. \varnothing 24mm slide ring H 15.5mm slide ring int. \varnothing 11mm counter ring mounting \varnothing 24mm height counter ring 8mm counter ring int. \varnothing 13.5mm		
	GEV No.	521513	Ref. No. —
	pump cover FIR inlet \varnothing 63mm outlet \varnothing 47mm turn direction right ID \varnothing 150mm inner height 32mm		
	GEV No.	524416	Ref. No. —
	pump cover gasket thickness 4x4mm Qty 1 pcs		



1

GEV No.	500479	Ref. No.	351934 3519340
description	pump inlet \varnothing 45mm outlet \varnothing 40mm type 3911.1423 230V 50Hz 1 phase 0.56kW 0.75HP L 204mm rotation direction right capacitor 10 μ F FIR		
spare parts for	500479		
	GEV No.	365015	Ref. No. —
	operating capacitor capacity 10 μ F 400V tolerance 5%Hz ambient temperature max. -25 to +85°C \varnothing 35.5mm L 59mm M8 plastic connection male faston 6.3mm protection		



Зип Общедит
vsezip.ru
+7(812)987-08-81

booster pumps I



1

GEV No.	500060	Ref. No.	351930 3519300
description	pump inlet ø 1" outlet ø 1" type PQM60 230V 50Hz 1 phase 0.37kW PEDRELLO		
accessories for	500060		
	GEV No.	Ref. No.	—
	365015		
description	operating capacitor capacity 10µF 400V tolerance 5%Hz ambient temperature max. -25 to +85°C ø 35.5mm L 59mm M8 plastic connection male faston 6.3mm protection		

accessories



1

GEV No.	365017	Ref. No.	334600 3346000
description	operating capacitor capacity 5µF 450V tolerance 5% 50/60Hz ambient temperature max. -25 to +85°C ø 28mm L 54mm M8 plastic connection male faston 6.3mm 16.10.08 protection		



1

GEV No.	500478	Ref. No.	351942 3519420 351948 3519480
description	pump inlet ø 13mm outlet ø 13mm type C.4035 230V 0.28kW ALBA PUMPS (C&A) turn direction left		

condensators & interference suppression filters

operating capacitors

plastic



1

GEV No.	365017	Ref. No.	334600 3346000
description	operating capacitor capacity 5µF 450V tolerance 5% 50/60Hz ambient temperature max. -25 to +85°C ø 28mm L 54mm M8 plastic connection male faston 6.3mm 16.10.08 protection		

drain pumps

ASKOLL



1

GEV No.	500210	Ref. No.	351935 3519350
description	drain pump 230V 40W		

filters

interference suppression filters



1

GEV No.	365044	Ref. No.	334606 3346060
description	interference suppression filter type FC701Y2F 250V 50-60Hz conductor 2 with E connection cable 200mm L 42mm ø 23mm Hmm Wmm plastic Qty 1 pcs		

1 electric components



Зип-Общепит

connection terminals with faston connections



GEV No.	550754	Ref. No.	308610 3086100
description	connection terminal 6-pole max. 16A max 380V		

terminal boards



GEV No.	550413	Ref. No.	308611 3086110
description	terminal board 3-pole thread M5 L 55mm W 36mm		

equipment-specific units

for espresso machines

brewing units

filter holder gaskets

O-rings



GEV No.	510409	Ref. No.	218845 2188450
description	O-ring EPDM thickness 5.34mm ID ø 56.52mm Qty 1 pcs		

for dishwashers

drain and intake components

LASA

drain /intake bodies



GEV No.	501356	Ref. No.	2440050 2440051	
description	drain fitting thread 1 1/2" ID ø 35mm L 40mm end piece ext. ø 57mm			
accessories for	501356			
	GEV No.	505180	Ref. No.	—
	O-ring EPDM thickness 3.53mm ID ø 47.22mm Qty 1 pcs			

Table continues overleaf

fuses

screw locks

D0-system (NEOZED)



GEV No.	358072	Ref. No.	316823 3168230
description	fuse size D01 6A rated 250/400V E14 ø 11mm L 36mm Qty 10 pcs		

fuse holders



GEV No.	358000	Ref. No.	342628 3426280 342629 3426290
description	fuse holder suitable fuse D01 16A rated 400V for DIN rail mounting suitable for D01		

electric accessories

terminals

connection terminals with screw/faston connections



GEV No.	550278	Ref. No.	308200 3082000
description	power terminal block 3-pole max. 40A max 400V connection ø6mm ² / F6.3 temp.-resist. 150°C cross section 6mm ²		



GEV No.	550411	Ref. No.	308300 3083000
description	power terminal block 6-pole max. 40A max 450V connection ø6mm ² / F6.3 temp.-resist. 150°C cross section 6mm ²		



1 electric components



Зип Общепит
vsezip.ru
+7(812)987-08-81



accessories for		501356	
	GEV No.	506224	Ref. No.
			244004 2440040 267160 2671600
nut thread 1½" plastic			

	1		
GEV No.	507374	Ref. No.	267340 2673400 (old version) 3589
description drain fitting thread 1¼"			
spare parts for 507374			

	GEV No.	507058	Ref. No.	267120 2671200 3591
screw connection thread 1¼" H 14mm WS 55				
	GEV No.	507373	Ref. No.	241430 2414300 3588
threaded rod L 42mm				

	1		
GEV No.	507577	Ref. No.	2673400
description drain fitting thread 1¼" H 87mm			

	1		
GEV No.	501374	Ref. No.	6490890
description drain fitting thread 1½" ID ø 39mm L 40mm hose ø 41mm			

 <p>Image not available</p>				
1				
GEV No.	511916	Ref. No.	260970 2609700	
description intake body				
spare parts for 511916				
	GEV No.	511917	Ref. No.	260969 2609690
intake filter				

	1		
GEV No.	506224	Ref. No.	244004 2440040 267160 2671600
description nut thread 1½" plastic			

	1		
GEV No.	532537	Ref. No.	2188600
description O-ring EPDM thickness 3.53mm ID ø 113.9mm Qty 1 pcs			

	1		
GEV No.	507058	Ref. No.	267120 2671200 3591
description screw connection thread 1¼" H 14mm WS 55			

filters			
	1		
GEV No.	524928	Ref. No.	743176
description flat filter L 560mm W 270mm H 20mm with hole mounting pos. right for dishwasher SS			



	1		
GEV No.	524929	Ref. No.	743177
description flat filter L 560mm W 270mm H 20mm without hole mounting pos. left for dishwasher SS			

Зип-Общепит

complete

vsezip.ru

+7(812)987-08-81

			
1			
GEV No.	511917	Ref. No.	260969 2609690
description	intake filter		
spare parts for	511917		
	GEV No.	511916	Ref. No. 260970 2609700
description	intake body		

			
1			
GEV No.	507373	Ref. No.	241430 2414300 3588
description	threaded rod L 42mm		

overflow pipes



			
1			
GEV No.	519454	Ref. No.	2609710
description	overflow pipe \varnothing 31mm L 238mm ID \varnothing 27mm ED \varnothing 31mm thickness 3mm		

			
1			
GEV No.	501357	Ref. No.	7451360 7451780
description	overflow pipe \varnothing 40mm L 460mm stainless steel		

softener cartridges

softening columns

			
1			
GEV No.	530000	Ref. No.	346100 3461000 346200 3462000
description	softener 4-fold L 380mm W 180mm		

			
1			
GEV No.	516086	Ref. No.	3464020
description	softener		
spare parts for	516086		
	GEV No.	516087	Ref. No. —
description	container lid		

hood mechanics for dishwashers

springs

			
1			
GEV No.	511968	Ref. No.	238517 2385170
description	spring for hood mechanics L 383mm wire gauge \varnothing 5.5mm \varnothing 43mm		

air traps

air traps

			
1			
GEV No.	510343	Ref. No.	277561 2775610
description	air trap L 140mm \varnothing 33mm plastic		

			
1			
GEV No.	511454	Ref. No.	260968 2609680 2609680+2185600+2023250+2035650 2609680+2187700+2023250+2035650
description	air trap W 45mm H 95mm		







Зип Общепит
vsezip.ru
+7(812)987-08-81

door mechanics

locks

			
1			
GEV No.	510628	Ref. No.	2609880
description	catch hook plastic for door latch		

			
1			
GEV No.	510627	Ref. No.	2609870
description	housing plastic for door latch		
accessories for	510627		
	GEV No.	Ref. No.	
	510628	2609880	
	description	catch hook plastic for door latch	
	GEV No.	Ref. No.	
	510629	2385150	
	description	spring for door latch	

			
1			
GEV No.	510629	Ref. No.	2385150
description	spring for door latch		

screw connections

			
1			
GEV No.	507058	Ref. No.	267120 2671200 3591
description	screw connection thread 1/4" H 14mm WS 55		

washing and rinsing systems

			
1			
GEV No.	524932	Ref. No.	266002
description	extension for wash arm support ø 68/62mm ID ø 53mm H 60mm		

			
1			
GEV No.	524933	Ref. No.	270302 2703020
description	gasket for wash arm support ø 100mm ID ø 68mm thickness 7mm		

			
1			
GEV No.	510238	Ref. No.	230598 2305980
description	knurled nut ø 27mm H 13.4mm wash arm support		

			
1			
GEV No.	519469	Ref. No.	260974 2609740
description	screw connection for wash arm support mounting pos. lower		

washing and rinsing systems (sorted by producer)

LASA

			
1			
GEV No.	518084	Ref. No.	260983 2609830
description	rinse arm L 215mm nozzles 4 mounting ø 18mm mounting pos. upper/lower		

			
1			
GEV No.	518083	Ref. No.	2610010
description	wash arm L 190mm nozzles 4 mounting ø 31.7mm mounting pos. upper/lower ø 32mm		



1

GEV No.	510237	Ref. No.	2600130
description	rinse jet H 18mm		



1

GEV No.	524931	Ref. No.	261003 2610030
description	wash arm boss mounting pos. upper/lower ø 71mm ID ø 59mm L 135mm W 88mm H 62mm		



1

GEV No.	519453	Ref. No.	260973 2609730 644657 6446570
description	wash arm support mounting pos. lower		

accessories for 519453

GEV No.	519469	Ref. No.	260974 2609740
screw connection for wash arm support mounting pos. lower			



1

GEV No.	519452	Ref. No.	260976 2609760
description	wash arm support mounting pos. upper ø 41mm H 64mm		

knobs

producer-specific knobs

LASA



1

GEV No.	111816	Ref. No.	263500 2635000
description	knob ø 20mm shaft ø 6x4.6mm shaft flat universal red		

Зип Общепит

vsezip.ru

+7(812)987-08-81

**GEV No.**

111815

Ref. No.260016
2600160
644660
6446600
6446600+2004400**description** knob switch zero mark ø 45mm shaft ø 6x4.6mm shaft flat right

1

GEV No.

112550

Ref. No.260007
2600070
644656
6446560**description** knob switch zero mark ø 45mm shaft ø 6x4.6mm shaft flat right black

accessories

gaskets



1

GEV No. 112563 **Ref. No.** 270310**description** gasket for shaft D1 ø 16mm D2 ø 6mm

rosettes



1

GEV No. 112551 **Ref. No.** 260010
2600100**description** rosette for knob up to ø 45mm

1

GEV No. 112552 **Ref. No.** 260009
2600090**description** rosette for knob up to ø 45mm



gaskets

O-rings

EPDM



GEV No.	510302	Ref. No.	218852 2188520
description	O-ring EPDM ID ø 12.42mm thickness 1.78mm Qty 1 pcs		



GEV No.	504512	Ref. No.	2182550
description	O-ring EPDM thickness 1.78mm ID ø 14mm Qty 1 pcs		



GEV No.	510303	Ref. No.	218030 2180300
description	O-ring EPDM thickness 1.78mm ID ø 6.75mm Qty 1 pcs		



GEV No.	532062	Ref. No.	2185700
description	O-ring EPDM thickness 2.62mm ID ø 29.82mm Qty 10 pcs		



GEV No.	532537	Ref. No.	2188600
description	O-ring EPDM thickness 3.53mm ID ø 113.9mm Qty 1 pcs		



GEV No.	510408	Ref. No.	218800 2188000 218840 2188400
description	O-ring EPDM thickness 5.34mm ID ø 47mm Qty 1 pcs		

Зип Общепит

vsezip.ru

+7(812)987-08-81



GEV No.	510409	Ref. No.	218845 2188450
description	O-ring EPDM thickness 5.34mm ID ø 56.52mm Qty 1 pcs		

silicone



GEV No.	532650	Ref. No.	218560 2185600 218770 2187700
description	O-ring silicone thickness 3.53mm ID ø 15.47mm Qty 1 pcs		

Viton

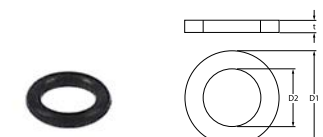

GEV No.	371095	Ref. No.	2182100
description	O-ring Viton thickness 1.78mm ID ø 6.07mm Qty 1 pcs		

NBR



GEV No.	532651	Ref. No.	218130
description	O-ring NBR thickness 3.53mm ID ø 71.44mm Qty 1 pcs		

springs

miscellaneous



GEV No.	511969	Ref. No.	238512
description	protection spring shaft diametermm ø 11mm L 112mm Wmm Hmm wire gauge ø 0.6mm		

manometers

			
1			
GEV No.	541272	Ref. No.	326728 3267280
description	manometer ø 40mm pressure range 0 up tp 4bar thread 1/8" connection on the backside		

dosing pumps

membrane dosing pumps



self-priming

various

			
1			
GEV No.	361015	Ref. No.	3489010
description	dosing pump membrane dosing pump rinse aid inlet 6x8mm outlet 4x6mm pressure connection ø 4x6mm suction connection ø 6x8mm		
spare parts for	361015		
	GEV No.	361132	Ref. No. —
membrane dosing pump			
	GEV No.	510298	Ref. No. —
lip valve dosing pump suitable for DB2/DS5			





			
1			
GEV No.	361741	Ref. No.	3489030
description	dosing pump type model 2 rinse aid inlet 4x6mm outlet 4x6mm pressure connection ø 4x6mm suction connection ø 4x6mm		
spare parts for	361741		
	GEV No.	361307	Ref. No. —
membrane dosing pump ø 68mm hole ø 6mm for type DIB3P/DIB5P			
	GEV No.	361459	Ref. No. —
hose connector ø 6mm for dosing pump			
	GEV No.	361462	Ref. No. —
container filter with weight SS hose ø 4x6mm			

Зип-Общепит

spare parts for 361741			
	GEV No.	508116	Ref. No. —
union nut thread M10x1 H 16mm WS 16 plastic Qty 1 pcs			
	GEV No.	508123	Ref. No. —
T-piece 3-way hose ø 10x15mm plastic			
	GEV No.	520090	Ref. No. —
PVC hose ID ø 4mm ED ø 6mm L 2m thickness 1mm t.max. 60°C transparent			

self-priming with supporting pressure

OMNIWASH

			
1			
GEV No.	361054	Ref. No.	3229 3929
description	dosing pump rinse aid pressure connection ø 6mm suction connection ø 6mm auxiliary pressure connection 10mm		
spare parts for	361054		
	GEV No.	361308	Ref. No. —
membrane rinse aid pressure connection ømm suction connection ømm auxiliary pressure connectionmm			
	GEV No.	361348	Ref. No. —
lip valve rinse aid pressure connection ømm suction connection ømm auxiliary pressure connectionmm			
accessories for	361054		
	GEV No.	520252	Ref. No. —
nylon hose ID ø 6mm ED ø 8mm L 5m thickness 1mm operating p. 10bar burst p. 50bar t.max. 100°C white			
	GEV No.	520278	Ref. No. —
PVC hose ID ø 6mm ED ø 8mm L 2m thickness 1mm t.max. 60°C transparent			

hoses

formed hoses

straight

			
1			
GEV No.	504273	Ref. No.	193318 1933180 271245 2712450
description	extraction hose hose ext. ø 68mm hose int. ø 60mm L 150mm		



Зип Общепит
ancillary products

vsezip.ru
hose clamps

DIN 3017 -W2
+7(812)987-08-81



1

GEV No.	519455	Ref. No.	270317 2703170
description	formed hose hose ext. ø 50/60mm hose int. ø 38/48mm L 69mm dishwasher black Qty 1		

with branch



1

GEV No.	524930	Ref. No.	270313 2703130
description	formed hose ext. ø 62/55 D1 ø 43mm D2 ø 49mm L 170mm warewashing black		

for dishwashers

miscellaneous



1

GEV No.	510806	Ref. No.	6422180
description	extraction hose ED ø 8mm ID ø 5mm Qty supplied by meter		

fittings, hose and pipe connectors

hose connectors

without screw connection



1

GEV No.	541109	Ref. No.	260032 2600320
description	Y-piece plastic hose ø 8-6-8mm for pressure switch		

clamps

hose clamps

DIN 3017 -W2



1

GEV No.	520111	Ref. No.	2140960
description	hose clamp ø 10-16mm width 9mm Qty 10 pcs DIN 3017		

fastening material

nuts

hexagonal nuts

DIN 934 / ISO 4032/8673



1

GEV No.	560340	Ref. No.	3231 3676
description	hexagonal nut thread M4 H 3.2mm WS 7 SS DIN/ISO DIN 934 / ISO 4032/8673 Qty 1 pcs		

fasteners

clamps

hose clamps

DIN 3017 -W2



1

GEV No.	520111	Ref. No.	2140960
description	hose clamp ø 10-16mm width 9mm Qty 10 pcs DIN 3017		

Зип Общепит

vsezip.ru

+7(812)987-08-81

consumables

fuses

screw locks

D0-system (NEOZED)



1

GEV No.	358072	Ref. No.	316823 3168230
description	fuse size D01 6A rated 250/400V E14 ø 11mm L 36mm Qty 10 pcs		

Зип Общепит

O-rings

21

B

bi-metal thermostats	5, 5
booster pumps I	15
booster pumps II	15

C

cam switches	8
clamps	23, 23
condensators & interference suppression filters	15
consumables	24
contactors	10
control thermostats	6, 6

D

dosing pumps	22
drain pumps	15

E

electric accessories	16
----------------------	----

F

fasteners	23
fastening material	23
filters	15
formed hoses	22
fuses	16, 24

H

heating elements	3
heating elements for pasta cookers	3
heating elements for salamanders/toasters	3
hexagonal nuts	23
hose clamps	23, 23
hose connectors	23
hoses	22

I

immersion heating elements	3
indicator lights	8

L

lamps	8
-------	---

M

magnetic switches	8
microswitches	7

N

nuts	23
------	----

O

operating capacitors	15
----------------------	----

vsezip.ru

+7(812)987-08-81

plunger sockets	7
-----------------	---

position switches	7
-------------------	---

pressure switches	12
-------------------	----

programme timers	9
------------------	---

pumps	13
-------	----

push/momentary push switches	7
------------------------------	---

R

relays	11
--------	----

rocker/momentary rocker switches	7
----------------------------------	---

rotary switches	8
-----------------	---

S

safety thermostats	6, 6
--------------------	------

screw locks	24
-------------	----

solenoid valves	11
-----------------	----

switches and momentary switches	7
---------------------------------	---

T

terminals	16
-----------	----

thermostats	5
-------------	---

timers	9
--------	---

W

wash and rinse pumps	13
----------------------	----