



Зип Ощепит

vsezip.ru

Spare Parts for

+7(812)987-08781 **Combi Ovens**



Spare parts suitable for

GIERRE

2017

Find the complete and up-to-date range of products in our GEV Webshop



heating elements

heating elements for ovens

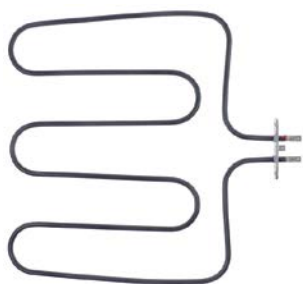

1

GEV No.	418792	Ref. No.	RES155
description	heating element 1400W 230V heating circuits 1 L 315mm W 320mm L1 55mm L2 260mm W1 150mm W2 30mm flange length 70mm flange width 22mm hole distance 56mm hole ϕ 4.2mm tube ϕ 6.3mm connection male faston 6.3mm rectangular flange		

heating elements for convection



1

GEV No.	418998	Ref. No.	KITRES230
description	heating element 3000W 230V heating circuits 1 ID ϕ 182mm ED ϕ 195mm L 245mm H 52mm L1 45mm W1 30mm H1 25mm H2 27mm flange length 70mm flange width 22mm hole distance 56mm connection male faston 6.3mm connection length 44mm tube ϕ 6.2mm convection heating element hole ϕ 5mm		



1

GEV No.	418503	Ref. No.	RES101
description	heating element 7500W 230V heating circuits 3 ID ϕ 305mm ED ϕ 315mm L 350mm H 106mm L1 27mm W1 105mm H1 16mm H2 90mm flange length 142mm flange width 25mm hole distance 63mm connection M4 connection length 72mm tube ϕ 6.5mm convection heating element hole ϕ 6.3mm rectangular flange		

Зип Общепит

energy regulators

vsezip.ru

+7(812)987-08-81

EGO

1-circuit



1

GEV No.	380015	Ref. No.	SIM123
description	energy regulator 230V 13A single-circuit turn direction right shaft ϕ 6x4.6mm shaft L 23mm mounting thread M4 power release 6-100% no. 50.57021.010		

thermostats

control and safety thermostats

EGO

control thermostats

55.10/19_ series



1

GEV No.	375652	Ref. No.	TER114
description	thermostat t.max. 266°C temperature range 50-255°C 1-pole 1NO 16A probe ϕ 3mm probe L 219mm capillary pipe 900mm capillary pipe isolated 350mm gland nut M10x1 shaft ϕ 6x4.6mm shaft L 23mm shaft position upper rotation 270°		

EGO



1

GEV No.	375664	Ref. No.	TER109
description	thermostat t.max. 287°C temperature range 60-287°C 1-pole 1NO 16A probe ϕ 3.1mm probe L 226mm capillary pipe 1470mm capillary pipe isolated 350mm gland nut shaft ϕ 6x4.6mm shaft L 23mm shaft position upper rotation 270°		



Зип Общепит
microswitches

lever actuated
vsezip.ru

+7(812)987-08-81



GEV No.	375860	Ref. No.	TER202.05015 TER205.05015
description	thermostat t.max. 289°C temperature range 57-289°C 1-pole 1NO 16A probe ø 3.1mm probe L 226mm capillary pipe 1780mm capillary pipe isolated 1770mm gland nut shaft ø 6x4.6mm shaft L 23mm shaft position upper° rotation 270° probe material SS		



GEV No.	345044	Ref. No.	MIC500
description	microswitch with lever 250V 16A 1CO connection male faston 6.3mm ambient temperature max. 85°C mounting distance 25mm type C99ZP3 actuating force: 25g lever length 71mm		

safety thermostats

55.10/19_ series



GEV No.	375807	Ref. No.	TER116
description	safety thermostat switch-off temp. 320°C 1-pole 16A probe ø 6mm probe L 77mm capillary pipe 870mm capillary pipe isolated 660mm gland nut M10x1 probe		

pin-plunger actuated

M12



GEV No.	345694	Ref. No.	MIC209
description	microswitch with plunger mounting distance 25mm thread M12x1 thread L 14mm 250V 16A 1CO connection screw stroke 4mm L 49mm ambient temperature max. 125°C type MS10 actuating force: 350g		

switches and momentary switches

push/momentary push switches

ø25mm



GEV No.	345160 ¹	Ref. No.	INT123
description	push switch mounting ø 25mm red 2NO 250V 16A illuminated connection male faston 6.3mm ambient temperature max. 85°C protection IP40		

¹illuminated

cam switches

on/off



GEV No.	300129	Ref. No.	COM123
description	cam switch 2 operating positions 2NO sequence 0-1 16A shaft ø 6x4.6mm shaft L 23mm connection male faston 6.3mm ceramic		

3 operating positions

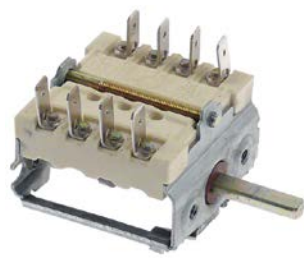

GEV No.	301315	Ref. No.	COM140
description	cam switch 3 operating positions 4NO sequence 1-0-2 16A shaft ø 6x4.6mm shaft L 23mm connection male faston 6.3mm 49.44915.712 ceramic		



rotary switches

BREMAS

A1200 series



1

GEV No.	346600	Ref. No.	COM160
description	rotary switch sets of contacts 8 4 0-1-2-3 type CS012461B 400V 12A shaft \varnothing 4x5mm shaft L 25mm shaft square connection male faston 6.3mm		

lamps

indicator lights

indicator lights (complete)

 \varnothing 10mm

with plug-in socket



1

GEV No.	359139	Ref. No.	SEG311 XSEG311
description	indicator light \varnothing 10mm green 230V connection male faston 6.3mm Qty 1 pcs		



1

GEV No.	359140	Ref. No.	SEG312 XSEG312
description	indicator light \varnothing 10mm yellow 230V connection male faston 6.3mm Qty 1 pcs		

screw-on/push-on fit

halogen lamp

for socket G4 / G6.35 / G9



1

GEV No.	359599	Ref. No.	LAM125
description	halogen lamp socket G4 12V 20W temp.-resist. 500°C		

Зип-Общепит

oven lamps

lamps

halogen lamps

for socket G4 / G6.35 / G9



1

GEV No.	359599	Ref. No.	LAM125
description	halogen lamp socket G4 12V 20W temp.-resist. 500°C		

sockets

G4 / G5,3 / G6,35



1

GEV No.	359369	Ref. No.	POR150/3
description	lamp socket socket G4/G5.3/G6.35 24V \varnothing 17mm H 10mm connection cable 120mm mounting distance 11.5mm for halogen lamp cable length 730mm		

timers

programme timers



1

GEV No.	360633	Ref. No.	TEM105
description	time switch kit 14000F3 operation time 120min impulse electric shaft \varnothing 6x4.6mm shaft L 20mm CDC 230V engines 1 chambers 2		



1

GEV No.	360627	Ref. No.	TEM115
description	timer FIBER P255J03H9U3c engines 1 chambers 3 operation time 6min 230V 50/60Hz shaft \varnothing 6mm shaft Lmm motor type M51BJ0R00AA		



electric timers

Зип Общепит

vsezip.ru

+7(812)987-08-81



1

GEV No.	350194	Ref. No.	TEM160
description	timer MS65 with bell operation time 60min time spreadmin 2NO at 250V 16A permanent position yes impulse electric shaft ø 6x4.6mm shaft L 23mm mounting distance 29mm mounting thread M4 connection male faston 6.3mm Invensys 230V voltage AC 2-pole		

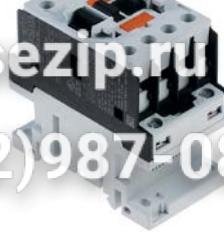

1

GEV No.	380714	Ref. No.	TEL145
description	power contactor resistive load 25A 230VAC (AC3/400V) 9A/4.2kW main contacts 3NO auxiliary contacts 1NO connection screw connection type BF0910A230		

mechanical timers



1

GEV No.	350061	Ref. No.	TEM1243 ZTEM1243
description	timer DTJ with bell 2-pole operation time 120min impulse mechanical 2NO at 250V 16A permanent position yes shaft ø 6x4.6mm shaft 6x4.6mm shaft L 24mm mounting distance 28mm connection lateral		

relays

level relays

GICAR



1

GEV No.	401224	Ref. No.	PRO065/1
description	level relay 230V connection F6.3 type RL30/3ES/F/G		

alarm devices

buzzer boards



1

GEV No.	401062	Ref. No.	TEM105/1
description	buzzer board 230VAC L 48mm W 45mm connection Faston 6.3mm		

solenoid valves

solenoid valves (water)

RPE



1

GEV No.	370379	Ref. No.	VAL110
description	solenoid valve double straight 230VAC inlet 3/4" outlet 1/4" DN10 RPE plastic inlet 3/4"mm		

contactors

LOVATO

power contactors



1

GEV No.	380083	Ref. No.	TEL144
description	power contactor resistive load 25A 230VAC (AC3/400V) 9A/4.2kW main contacts 3NO auxiliary contacts 1NC connection screw connection type BF0901A230		

1 electric components























Зип-Общепит

vsezip.ru

+7(812)987-08-81

electric components



TP			
			
GEV No.	370025	Ref. No.	VAL1000
description	solenoid valve triple straight 230VAC inlet 3/4" outlet 11.5mm DN10 TP		
spare parts for	370025		
	GEV No.	371013	Ref. No. —
	solenoid coil TP 230VAC 50/60Hz		
accessories for	370025		
	GEV No.	371220	Ref. No. —
	reducer TP flow rate 3l/min red tolerance ±15%		
	GEV No.	371221	Ref. No. —
	reducer TP flow rate 5.5l/min yellow tolerance ±15%		
	GEV No.	371222	Ref. No. —
	reducer TP flow rate 6l/min grey tolerance ±15%		
	GEV No.	371223	Ref. No. —
	reducer TP flow rate 10l/min white tolerance ±15%		
	GEV No.	371224	Ref. No. —
	reducer TP flow rate 12l/min bronze tolerance ±15%		
	GEV No.	371225	Ref. No. —
	reducer TP flow rate 16l/min light brown tolerance ±15%		
	GEV No.	371226	Ref. No. —
	reducer TP flow rate 20l/min red tolerance ±15%		
	GEV No.	371230	Ref. No. —
	reducer TP flow rate 0.25l/min red tolerance ±25%		
	GEV No.	371231	Ref. No. —
	reducer TP flow rate 0.35l/min violet tolerance ±25%		
	GEV No.	371232	Ref. No. —
	reducer TP flow rate 0.5l/min orange tolerance ±25%		
	GEV No.	371233	Ref. No. —
	reducer TP flow rate 0.8l/min white tolerance ±25%		
	GEV No.	371234	Ref. No. —
	reducer TP flow rate 1l/min light blue tolerance ±25%		
	GEV No.	371235	Ref. No. —
	reducer TP flow rate 1.2l/min brown tolerance ±25%		
	GEV No.	371236	Ref. No. —
	reducer TP flow rate 1.5l/min light brown tolerance ±25%		

accessories for 370025			
	GEV No.	371237	Ref. No. —
	reducer TP flow rate 2.5l/min yellow tolerance ±25%		
	GEV No.	371238	Ref. No. —
	reducer TP flow rate 3.4l/min dark green tolerance ±25%		
	GEV No.	371239	Ref. No. —
	reducer TP flow rate 5l/min black tolerance ±25%		
	GEV No.	371240	Ref. No. —
	reducer TP flow rate 8l/min blue tolerance ±20%		

ball valves electric

			
GEV No.	403042	Ref. No.	VAL550
description	ball valve inlet 3/4" IT outlet 3/4" IT 230V L 68mm closed off-current mode of operation electric connection cable 400mm		

electrodes

			
GEV No.	400260	Ref. No.	PRO065/2
description	level electrode 1/4" total length 220mm probe L 195mm insulated probe length 185mm PTFE insulated connection male faston 6.3mm stainless steel ø 2.5mm		
accessories for	400260		
	GEV No.	521003	Ref. No. —
	nut thread 1/4" H 6.3mm chrome-plated brass WS 20 Qty 1 pcs		



fans

hot air motors

Зип Общепит

vsezip.ru

+7(812)987-08-81

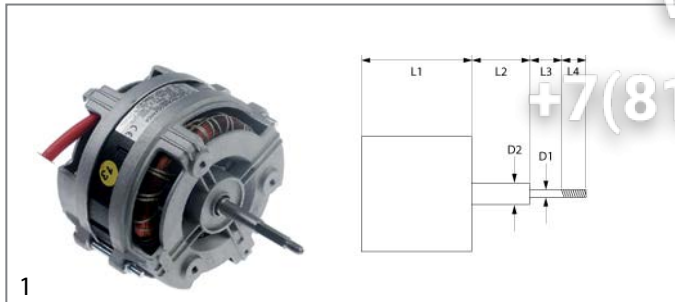

GEV No.	601648	Ref. No.	KITMOT310 MOT300
description	fan motor 220-240V 1 phase 50/60Hz 0.12kW 2800/3400rpm speeds 1 L1 95mm L2 32mm L3 23mm L4 12mm D1 ø 6x8mm D2 ø 10mm M6R ET 0.9A power input 0.12W at 50Hz 2800rpm at 60Hz 3400rpm suitable capacitor 6.3µF/450V		
accessories for	601648		
		GEV No.	365012 Ref. No. —
	operating capacitor capacity 6.3µF 450V tolerance 5% 50Hz ambient temperature max. -25 to +85°C ø 30mm L 61mm M8 plastic connection male faston 6.3mm protection		

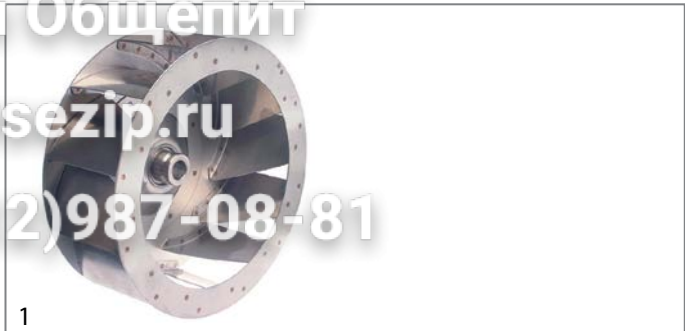

GEV No.	601355	Ref. No.	VEN127
description	fan wheel D1 ø 270mm H1 100mm blades 12 D2 ø 19.5mm D3 ø 23mm H2 45mm		

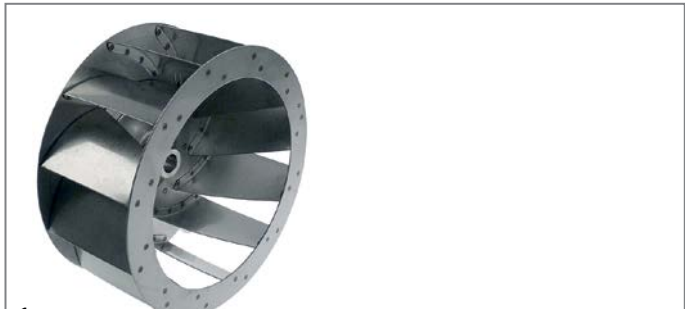

GEV No.	602023	Ref. No.	VEL100
description	fan wheel D1 ø 270mm H1 120mm blades 12 D2 ø 19.5mm D3 ø 23mm H2 46mm		

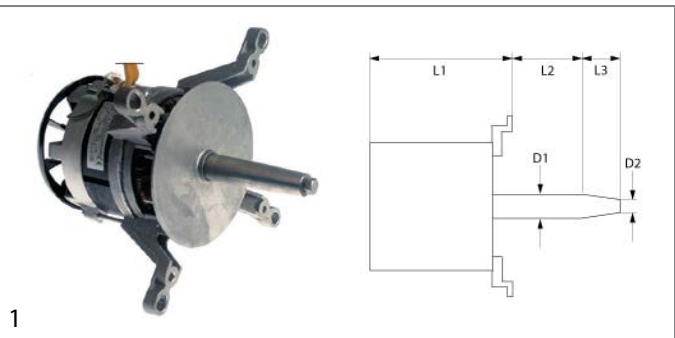

GEV No.	601356	Ref. No.	MOT103
description	fan motor 220-240V 1 phase 50Hz 0.37kW 1400rpm speeds 1 L1 168mm L2 45mm L3 47mm D1 ø 24mm D2 ø 20mm M8L IT 2A suitable capacitor 12.5µF/400V at 50Hz 1400rpm type 1021S2250		

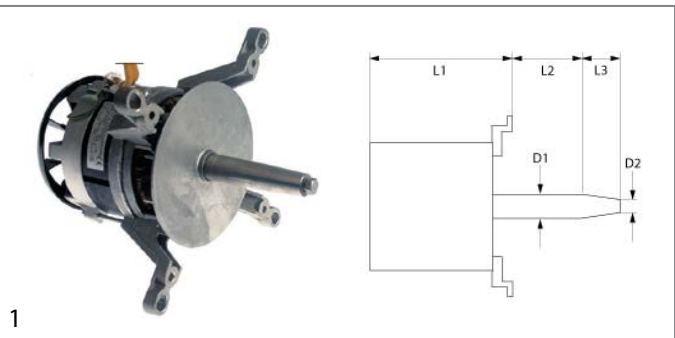

GEV No.	601544	Ref. No.	MOT101
description	fan motor 230/400V 3 phase 50Hz 0.5HP 1350rpm speeds 1 L1 168mm L2 45mm L3 27mm D1 ø 24mm D2 ø 20mm M8L IT 1.8/1A at 50Hz 1350rpm type FIR 1021		

hot air fans

miscellaneous



GEV No.	601011	Ref. No.	MOT214
description	hot air fan 220-240V 40W 50/60Hz L1 65mm L2 15mm L3 25mm L4 87mm fan wheel ø 150mm FIME type C25R8023CLH		
accessories for	601011		
		GEV No.	550879 Ref. No. ZMOT214/1
	insulation ø 130mm thickness 3mm hole ø 18mm for hot air fan		

Table continues overleaf



Зип.Общепит

LOCKS

vsezip.ru

+7(812)987-08-81

electric components

accessories for	601011		
	GEV No.	601260	Ref. No. —
	nut thread M6L IT for hot air fan		

handle latches
universal

inside fixing
locks



GEV No.	694054	Ref. No.	MAN710
description	door handle for headed units L 145mm W 40mm H 62mm spring length 33mm inner black		

accessories for	694054		
	GEV No.	514390	Ref. No. —
	spring for door handle ø 6mm L 54mm W 27.5mm		

	GEV No.	694675	Ref. No. —
	door catch L 88mm W 40mm H 37mm spring length 33mm mounting distance 60mm		

	GEV No.	694734	Ref. No. —
	door handle L 165mm W 40mm H 25mm black		

	GEV No.	694735	Ref. No. —
	cap ø 32mm black		

accessories for	694054		
	GEV No.	691123	Ref. No. —
	duct for door opener		

	GEV No.	694055	Ref. No. —
	door catch L 25mm W 14mm total length 54mm thread M8 thread L 29mm		

	GEV No.	694066	Ref. No. —
	door catch with spigot 2-stage L 28mm W 14mm H 15mm H1 16mm total length 51mm thread M8 thread L 23mm stainless steel		

	GEV No.	694067	Ref. No. MAN710/1
	door catch with spigot 1-stage L 26mm total length 51mm thread M8		

producer-specific

GIERRE

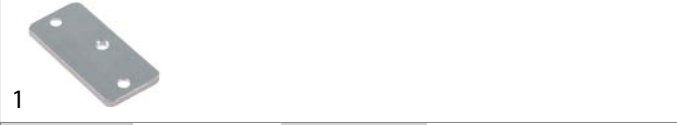

GEV No.	693840	Ref. No.	PIA530
description	base plate L 75mm W 35mm H 4mm for door handle mounting distance 60mm		

gas valves and ignition boxes

ignition boxes

SIT



GEV No.	103278	Ref. No.	ASM79521001 KITELE090300/1
description	ignition box kit SIT type 571DBC electrodes 2 waiting time 1.5s safety time 5s 250V 10VA 50/60Hz		

accessories for	103278		
	GEV No.	107246	Ref. No. —
	ignition box SIT type 571DBC electrodes 2 waiting time 1s safety time 10s 230V 12VA 50/60Hz		



GEV No.	107850	Ref. No.	ELE500/1
description	ignition box SIT type 579DBC electrodes 2 waiting time 1.5s safety time 6s 220/240V 12VA 50/60Hz		

for ovens

miscellaneous

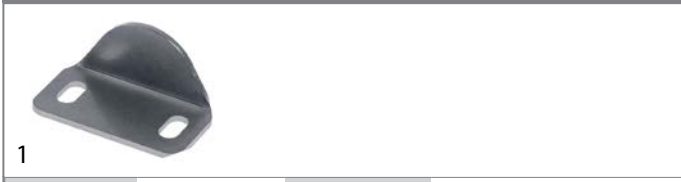

GEV No.	698648	Ref. No.	NSL100
description	counterpart for microswitch L 50mm W 28mm H 23mm		



Зип-Общепит

hinges

oven hinges

vsezip.ru

+7(812)987-08-81

			
1			
GEV No.	694067	Ref. No.	MAN710/1
description	door catch with spigot 1-stage L 26mm total length 51mm thread M8		

			
1			
GEV No.	694054	Ref. No.	MAN710
description	door handle for headed units L 145mm W 40mm H 62mm spring length 33mm inner black		

GEV No.	694054	Ref. No.	MAN710
----------------	--------	-----------------	--------

description door handle for headed units L 145mm W 40mm H 62mm spring length 33mm inner black

spare parts for 694054

	GEV No.	514390	Ref. No.	—
---	----------------	--------	-----------------	---

spring for door handle ø 6mm L 54mm W 27.5mm

	GEV No.	694675	Ref. No.	—
---	----------------	--------	-----------------	---

door catch L 88mm W 40mm H 37mm spring length 33mm mounting distance 60mm

	GEV No.	694734	Ref. No.	—
---	----------------	--------	-----------------	---

door handle L 165mm W 40mm H 25mm black

	GEV No.	694735	Ref. No.	—
---	----------------	--------	-----------------	---

cap ø 32mm black

accessories for 694054

	GEV No.	691123	Ref. No.	—
---	----------------	--------	-----------------	---

duct for door opener

	GEV No.	694055	Ref. No.	—
---	----------------	--------	-----------------	---

door catch L 25mm W 14mm total length 54mm thread M8 thread L 29mm

	GEV No.	694066	Ref. No.	—
---	----------------	--------	-----------------	---

door catch with spigot 2-stage L 28mm W 14mm H 15mm H1 16mm total length 51mm thread M8 thread L 23mm stainless steel

	GEV No.	694067	Ref. No.	MAN710/1
---	----------------	--------	-----------------	----------

door catch with spigot 1-stage L 26mm total length 51mm thread M8

			
1			
GEV No.	693045	Ref. No.	CER141/1
description	opposite support L 110mm W 12mm mounting distance 94mm		

GEV No.	693045	Ref. No.	CER141/1
description	opposite support L 110mm W 12mm mounting distance 94mm		

			
1			
GEV No.	690031	Ref. No.	CER151/1
description	opposite support oven hinge		

GEV No.	690031	Ref. No.	CER151/1
description	opposite support oven hinge		

			
1			
GEV No.	701118	Ref. No.	CER151
description	oven hinge lever length 126mm mounting ear position left L 155mm W 20mm Qty 1 pcs		

GEV No.	701118	Ref. No.	CER151
description	oven hinge lever length 126mm mounting ear position left L 155mm W 20mm Qty 1 pcs		

			
1			
GEV No.	694354	Ref. No.	CER145
description	oven hinge mounting distance 118mm lug mounting 13mm lever length 119mm groove distance 12mm spring thickness 4mm mounting ear position left spring length 53mm L 154mm W 22mm		

GEV No.	694354	Ref. No.	CER145
description	oven hinge mounting distance 118mm lug mounting 13mm lever length 119mm groove distance 12mm spring thickness 4mm mounting ear position left spring length 53mm L 154mm W 22mm		

mechanical components, equipment accessories

Зип.Общепит
gaskets

gaskets for heated units
vsezip.ru
door seals

+7(812)987-08-81

mechanical components, equipment accessories



1

GEV No.	694353	Ref. No.	CER146
description	oven hinge mounting distance 118mm lug mounting 13mm lever length 119mm groove distance 12mm spring thickness 4mm mounting ear position right spring length 53mm L 154mm W 22mm Qty 1 pcs		

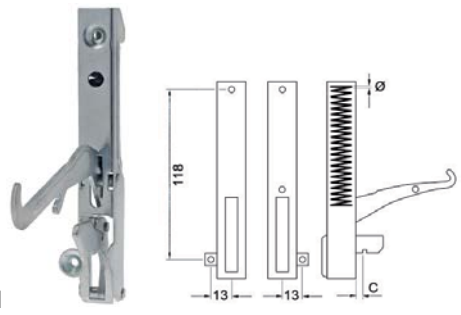

1

GEV No.	700013	Ref. No.	CER141
description	oven hinge mounting distance 118mm lug mounting 13mm lever length 119mm groove distance 13mm spring thickness 3.5mm mounting ear position left spring length 60mm L 154mm		
accessories for	700013		
	GEV No.	700003	Ref. No. —
	opposite support L 110mm W 12mm mounting distance 94mm		

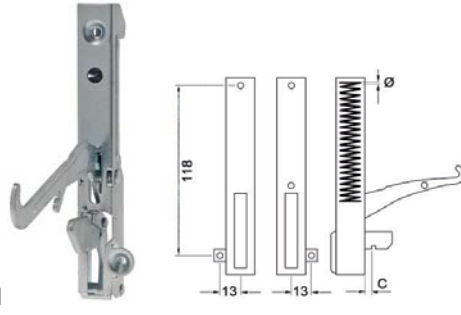

1

GEV No.	700014	Ref. No.	CER150
description	oven hinge mounting distance 118mm mounting distance 2mm lug mounting 13mm lever length 119mm groove distance 13mm spring thickness 3.5mm mounting ear position right spring length 60mm L 154mm		
accessories for	700014		
	GEV No.	700003	Ref. No. —
	opposite support L 110mm W 12mm mounting distance 94mm		

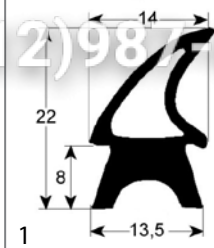

GEV No.	901688	Ref. No.	GUA400
description	door seal profile 2455 W 465mm L 745mm external size		

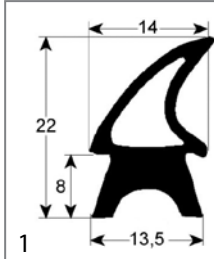

GEV No.	900770	Ref. No.	GUA500
description	door seal profile 2455 W 475mm L 650mm external size Qty 1		

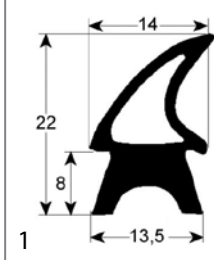

GEV No.	901689	Ref. No.	GUA090 GUA600 XXGUA600
description	door seal profile 2455 W 635mm L 1700mm external size		

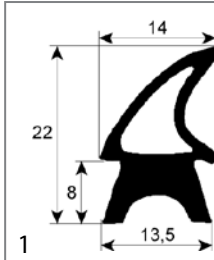

GEV No.	900771	Ref. No.	GUA510
description	door seal profile 2455 W 650mm L 870mm external size Qty 1		



Зип Общепит

vsezip.ru

+7(812)987-08-81

GEV No.	901687	Ref. No.	GUA410
description	door seal profile 2455 W 745mm L 865mm external size		

GEV No.	900773	Ref. No.	GUA312 GUA504.03040
description	oven gasket L 670mm W 280mm with 6 mounting clips external size		

GEV No.	901331	Ref. No.	GUA504.03060
description	door seal profile 2756 Qty supplied by meter		

valves and tank inlets

ball valves

ball valves electric

GEV No.	403042	Ref. No.	VAL550
description	ball valve inlet 3/4" IT outlet 3/4" IT 230V L 68mm closed off-current mode of operation electric connection cable 400mm		

GEV No.	900772	Ref. No.	GUA320
description	door seal profile 2926 L 1500mm Qty 1		

door seals with fixing hook

GEV No.	900774	Ref. No.	GUA315
description	oven gasket L 660mm W 350mm with 6 mounting clips external size		

water cycle components

pressure reduction valves

pressure reduction valves

producer-specific

GEV No.	541185	Ref. No.	MIC510
description	pressure controller Metal Work series Bit MRA connection 1/4" default settingbar setting range 0-8bar p max 13bar t.max. 50°C plastic thread 1/4"		

mechanical components, equipment accessories



fastening material

Зип Общепит

fasteners

vsezip.ru

roll pins

+7(812)987-08-81



1

GEV No.	691637	Ref. No.	SPI102
description	roll pin ø 3mm L 20mm		

Зип Общепит

vsezip.ru

+7(812)987-08-81

A			
alarm devices	5		
B			
ball valves	11		
ball valves electric	6, 11		
C			
cam switches	3		
contactors	5		
control thermostats	2		
D			
door seals	10		
door seals with fixing hook	11		
E			
electric timers	5		
electrodes	6		
energy regulators	2		
F			
fans	7		
fasteners	12		
fastening material	12		
G			
gaskets for heated units	10		
H			
halogen lamp	4		
heating elements	2		
heating elements for convection	2		
heating elements for ovens	2		
hot air fans	7		
hot air motors	7		
I			
ignition boxes	8		
indicator lights	4		
indicator lights (complete)	4		
L			
lamps	4		
M			
mechanical timers	5		
microswitches	3		
O			
oven hinges	9		
oven lamps	4		
P			
pressure reduction valves		11, 11	
programme timers		4	
push/momentary push switches		3	
R			
relays		5	
roll pins		12	
rotary switches		4	
S			
safety thermostats		3	
solenoid valves		5	
switches and momentary switches		3	
T			
thermostats		2	
timers		4	
V			
valves and tank inlets		11	
W			
water cycle components		11	