



Зип Общепит

vsezip.ru

+7(812)987-08-81



**GAS COMPONENTS**



**ELECTRIC COMPONENTS**



**WATER TECHNOLOGY**



**MECHANICAL COMPONENTS**



**TOOLS**

Spare parts suitable for

**DEXION**

Find the complete and up-to-date range of products in our GEV Webshop

Зип Общепит

vsezip.ru

+7(812)987-08-81

# Manufacturer catalogue

The most important spare parts and accessories arranged clearly for every manufacturer



**Complete product range and all appliance data always up to date in the GEV Webshop**







**Alphabetical Index at the end of the catalogue**

## GEV Webshop

[www.gev-online.co.uk](http://www.gev-online.co.uk)

[www.gev-online.com](http://www.gev-online.com)



-  Add to Favourites
-  Sign In with email address and usual password
-  Easy-order – place several items in your basket at the same time
-  Quick item search – no login needed



## heating elements

### heating elements for ovens

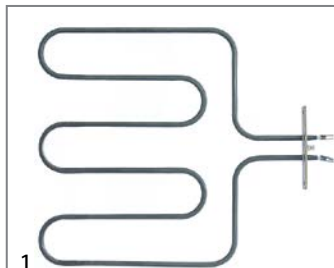

<b>GEV No.</b>	416541	<b>Ref. No.</b>	RIC0002548
<b>description</b>	heating element 1500W 230V heating circuits 1 L 350mm W 510mm L1 40mm L2 305mm W1 233mm W2 30mm flange length 100mm flange width 22mm hole distance 86mm hole $\varnothing$ 5mm tube $\varnothing$ 6.6mm connection male faston 6.3mm windings 3 rectangular flange dry heating element oven grill setin		
<b>For models:</b>	ME103-03-013XL, ME106-03-010XL, MG106-03-010, MG106-03-010XL		

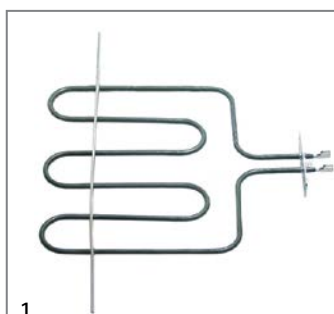

<b>GEV No.</b>	418495	<b>Ref. No.</b>	9303350400 RIC0001836
<b>description</b>	heating element 1800W 230V heating circuits 1 L 320mm W 287mm L1 78mm L2 242mm W1 127mm W2 30mm flange length 100mm flange width 22mm hole distance 86mm bridge length 480mm hole $\varnothing$ 5mm tube $\varnothing$ 6.3mm connection male faston 6.3mm connection length 35mm windings 3 rectangular flange dry heating element oven grill setin		
<b>For models:</b>	ME066-03-010, ME066-03-013, ME106-03-013, MG066-03-010		

### heating elements for bain maries

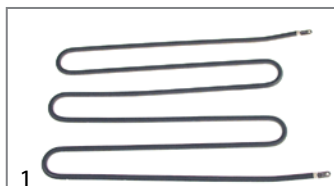

<b>GEV No.</b>	418344	<b>Ref. No.</b>	3710003
<b>description</b>	heating element 1200W 220V heating circuits 1 L 395mm W 220mm H 24mm connection M4 tube $\varnothing$ 8mm dry heating element L1 50mm L2 345mm connection distance 212mm		

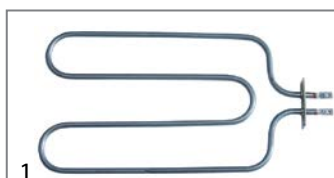

<b>GEV No.</b>	416554	<b>Ref. No.</b>	RTCU700280
<b>description</b>	heating element 1500W 230V heating circuits 1 L 355mm W 203mm flange length 70mm flange width 22mm hole distance 56mm connection M4 tube $\varnothing$ 8.5mm rectangular flange hole $\varnothing$ 5mm dry heating element L1 40mm L2 315mm W1 85mm W2 33mm		
<b>For models:</b>	ME046-03-003, ME066-03-006		

Зип Общепит

vsezip.ru

+7(812)987-08-81

<b>GEV No.</b>	416032	<b>Ref. No.</b>	013448-00 013448-00R
<b>description</b>	heating element 850W 230V heating circuits 1 L 430mm L1 30mm W 145mm connection M4 connection distance 140mm tube $\varnothing$ 6.5mm dry heating element bain marie L2 400mm H 16mm		

### heating elements for frying pans



<b>GEV No.</b>	416550	<b>Ref. No.</b>	RTCU600125
<b>description</b>	heating element 1500W 230V heating circuits 1 L 350mm W 155mm hole distance 141mm connection length 23mm connection M4 tube $\varnothing$ 8.6mm bracket mounting hole $\varnothing$ M5mm dry heating element L1 148mm L2 158mm H 30mm lug length 40mm lug width 18mm		
<b>For models:</b>	ME066-03-015		

### heating elements for fryers

#### off-center connection

#### with retaining rings



<b>GEV No.</b>	416557	<b>Ref. No.</b>	RTCU600122
<b>description</b>	heating element 9000W 230V heating circuits 3 mounting pos. right L 290mm W 202mm H 35mm thermostat sleeves $\varnothing$ M10mm number of thermostat sleeves 2 windings 5 L1 18mm L2 272mm W1 32mm W2 35mm tube $\varnothing$ 8.5mm cable length 375mm rotation flange immersion heater connection length 65mm		
<b>For models:</b>	ME046-03-004, ME066-03-007		

<b>accessories for</b>	416557			
	<b>GEV No.</b>	510243	<b>Ref. No.</b>	RTCU700565
	O-ring Viton thickness 3.53mm ID $\varnothing$ 55.56mm Qty 1 pcs			
	<b>GEV No.</b>	510244	<b>Ref. No.</b>	RTMIN00283
	retaining ring shaft $\varnothing$ 60mm thickness 2mm steel DIN 471			
	<b>GEV No.</b>	551117	<b>Ref. No.</b>	—
	plug conical $\varnothing$ 6.2/8mm L 37.5mm for probe rubber			

electric components

Зип Общежит  
heating elements for refrigeration

## 2 hole fixing

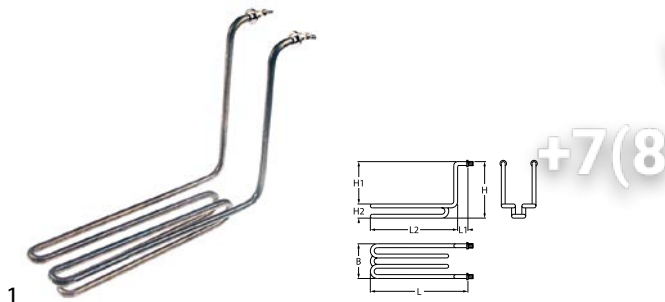

<b>GEV No.</b>	416889	<b>Ref. No.</b>	180588
----------------	--------	-----------------	--------

**description** heating element 2000W 230V heating circuits 1 L 310mm W 73mm H 225mm L1 40mm L2 270mm H1 190mm H2 36mm thread 1/4" mounting distance 65mm tube ø 8.5mm 2 hole fixing connection M5 fryer heaters windings 3

**accessories for** 416889

	<b>GEV No.</b>	361182	<b>Ref. No.</b>	—
	nut thread 1/4" H 5mm nickel-plated brass WS 17 Qty 1 pcs			
	<b>GEV No.</b>	510417	<b>Ref. No.</b>	—
	flat gasket fibre ED ø 20mm ID ø 14mm thickness 2mm Qty 1 pcs			
	<b>GEV No.</b>	520228	<b>Ref. No.</b>	—
	tooth lock washer ID ø 15.3mm ED ø 24mm steel Qty 1 pcs for thread M14			
	<b>GEV No.</b>	550262	<b>Ref. No.</b>	—
	flat gasket copper ED ø 20mm ID ø 14mm thickness 2mm			
	<b>GEV No.</b>	560112	<b>Ref. No.</b>	—
	plain washer ID ø 5.3mm ED ø 10mm thickness 1mm SS Qty 20 pcs DIN 125A for thread M5			
	<b>GEV No.</b>	560132	<b>Ref. No.</b>	—
	hexagonal nut thread M5 H 4mm WS 8 SS DIN/ISO DIN 934 / ISO 4032/8673 Qty 20 pcs			

## heating elements for griddles



<b>GEV No.</b>	416544	<b>Ref. No.</b>	RTCU600183
----------------	--------	-----------------	------------

**description** heating element 1250W 240V heating circuits 1 L 416mm W 70mm H 65mm tube ø 8.5mm connection M4 connection distance 53mm dry heating element

**For models:** ME046-03-001, ME046-03-002, ME046-13-001, ME046-13-002, ME066-03-003, ME066-03-004, ME066-13-003, ME106-13-003

## heating elements for defrosting



<b>GEV No.</b>	416313	<b>Ref. No.</b>	01152700R
----------------	--------	-----------------	-----------

**description** heating element 1100W 230V L 277mm W 630mm L1 54mm L2 223mm W1 40mm W2 590mm cable length 1500mm tube ø 6.3mm dry heating element defrosting

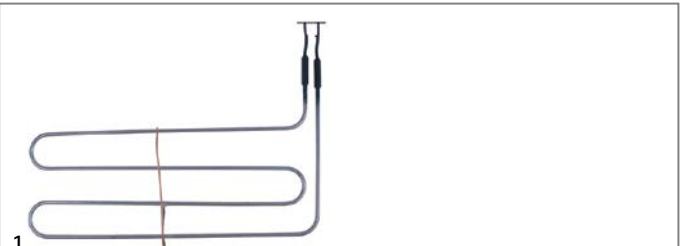

<b>GEV No.</b>	416312	<b>Ref. No.</b>	011526-00 011526-00R 011526-01 011526-01R
----------------	--------	-----------------	--

**description** heating element 550W 230V L 420mm W 210mm L1 26mm L2 394mm W1 45mm W2 165mm cable length 1500mm tube ø 6.3mm immersion heater defrosting connection cable suitable for DEXION

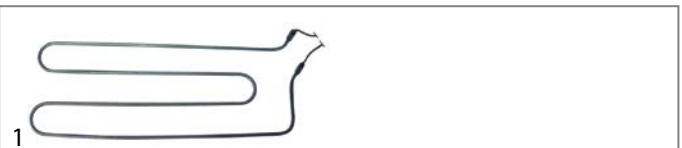

<b>GEV No.</b>	416418	<b>Ref. No.</b>	01447401R 022258-01R
----------------	--------	-----------------	-------------------------

**description** heating element 550W 230V L 440mm W 160mm H 60mm W1 85mm W2 42mm cable length 1500mm tube ø 6.3mm connection length 40mm immersion heater defrosting



<b>GEV No.</b>	420338	<b>Ref. No.</b>	022258-02R
----------------	--------	-----------------	------------

**description** heating element 550W 230V L 440mm W 180mm H 80mm W1 60mm W2 60mm connection Faston 6.3mm cable length 1500mm tube ø 6.25mm immersion heater with thermal fuse switch-off temp. 72°C

## heating elements for condensate evaporation



<b>GEV No.</b>	416374	<b>Ref. No.</b>	019430-02R
----------------	--------	-----------------	------------

**description** heating element 135W 230V L 480mm W 115mm Hmm cable length 2200mm tube ø 6.25mm



Зип Общежит  
heating cables

vsezip.ru  
connection on both sides  
with wire end ferrules

+7(812)987-08-81

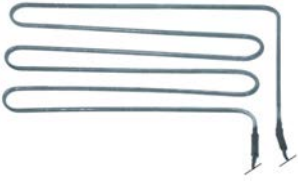

1

<b>GEV No.</b>	420393	<b>Ref. No.</b>	019014-00R
<b>description</b>	heating element 750W 230V L 425mm W 350mm for blast chiller suitable for DEXION		





1

<b>GEV No.</b>	416310	<b>Ref. No.</b>	00-556093 011524-00 011524-00R
<b>description</b>	heating cable 20W 230V L 6190mm L1 (unheated) 800mm L2 (heated) 4590mm silicone ø 3mm		

heating elements for pasta cookers



1

<b>GEV No.</b>	416552	<b>Ref. No.</b>	RTCU700283	
<b>description</b>	heating element 1850W 230V L 284mm W 48mm H 28mm 2 hole fixing connection M4 thread M16x1.5 tube ø 8.5mm L1 40mm L2 248mm mounting distance 40mm connection length 26mm pasta cooker immersion heater			
<b>For models:</b>	LX7EC4			
<b>spare parts for</b>	416552			
	<b>GEV No.</b>	521137	<b>Ref. No.</b>	—
<b>accessories for</b>	flat gasket fibre ED ø 20mm ID ø 18mm thickness 1.5mm for thread 3/8" Qty 1 pcs			
	<b>GEV No.</b>	361183	<b>Ref. No.</b>	—
<b>accessories for</b>	nut thread 3/8" H 6mm nickel-plated brass WS 20 Qty 1 pcs			



1



<b>GEV No.</b>	416311	<b>Ref. No.</b>	011525-00 011525-00R
<b>description</b>	heating cable 46W 230V 50Hz L 7560mm L1 (unheated) 800mm L2 (heated) 5960mm silicone door frame heating ø 3mm connection terminal		

ceramic heaters

245x60mm



1

<b>GEV No.</b>	415104	<b>Ref. No.</b>	RTCU600117	
<b>description</b>	ceramic emitter 1000W 230V cable beaded cord L 245mm W 60mm H 35mm			
<b>For models:</b>	ME046-03-005			
<b>spare parts for</b>	415104			
	<b>GEV No.</b>	415109	<b>Ref. No.</b>	—
<b>accessories for</b>	spring clip			
	<b>GEV No.</b>	415110	<b>Ref. No.</b>	—
<b>accessories for</b>	reflector L 245mm W 95mm H 31mm thickness 0.75mm hole ø 15x40mm			

heating elements for heated cabinets



1

<b>GEV No.</b>	418344	<b>Ref. No.</b>	3710003
<b>description</b>	heating element 1200W 220V heating circuits 1 L 395mm W 220mm H 24mm connection M4 tube ø 8mm dry heating element L1 50mm L2 345mm connection distance 212mm		

electric components



## immersion heating elements

## 3 hole flange ø47.5mm

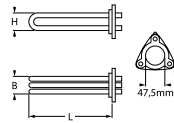

<b>GEV No.</b>	417440	<b>Ref. No.</b>	230111
<b>description</b>	heating element 4900W 230V mounting ø 47.5mm heating circuits 3 L 330mm W 32mm H 34mm number of thermostat sleeves 1 thermostat sleeves ø 7mm length thermostat sleeves 177mm thermostat sleeve not clinging tube ø 6.5mm hole distance 62mm hole ø 8mm connection M4 3 hole flange immersion heater		

For models: D501LS

accessories for 417440



<b>GEV No.</b>	510408	<b>Ref. No.</b>	456002 REB456002
----------------	--------	-----------------	---------------------

O-ring EPDM thickness 5.34mm ID ø 47mm Qty 1 pcs



<b>GEV No.</b>	510562	<b>Ref. No.</b>	—
----------------	--------	-----------------	---

O-ring silicone thickness 5.34mm ID ø 47mm Qty 1 pcs

## with round flange ø47.5mm



<b>GEV No.</b>	420057	<b>Ref. No.</b>	230116
<b>description</b>	heating element 3000W 230V heating circuits 1 mounting ø 47.5mm L 330mm W 33mm H 19mm tube ø 8.4mm thermostat sleeves ø 7.4mm number of thermostat sleeves 1 length thermostat sleeves 170mm		

For models: D500LS, D501LS

spare parts for 420057



<b>GEV No.</b>	510408	<b>Ref. No.</b>	456002 REB456002
----------------	--------	-----------------	---------------------

O-ring EPDM thickness 5.34mm ID ø 47mm Qty 1 pcs



<b>GEV No.</b>	415665	<b>Ref. No.</b>	230086
<b>description</b>	heating element 2750/3250W 220/240V heating circuits 1 L 380mm W 110mm H 30mm thread M10x1 mounting distance 75mm tube ø 6.5mm connection M4 immersion heater 2 hole fixing		

For models: D500LS, D501LS

spare parts for 415665



<b>GEV No.</b>	510893	<b>Ref. No.</b>	456015
----------------	--------	-----------------	--------

O-ring EPDM thickness 2.62mm ID ø 9.92mm Qty 1 pcs

accessories for 415665



<b>GEV No.</b>	510416	<b>Ref. No.</b>	—
<b>description</b>	flat gasket fibre ED ø 19mm ID ø 10.5mm thickness 1.5mm for thread M10 Qty 1 pcs		







<b>GEV No.</b>	520231	<b>Ref. No.</b>	—
----------------	--------	-----------------	---

nut thread M10x1 H 6mm WS 14 zinc-coated steel Qty 1 pcs

Зип-Общепит

vsezip.ru

+7(812)987-08-81

	<b>GEV No.</b>	521103	<b>Ref. No.</b>	—
<b>description</b>	nut thread M4 H 3mm WS 7 brass Qty 20 pcs			
	<b>GEV No.</b>	521104	<b>Ref. No.</b>	—
<b>description</b>	washer ID ø 4.3mm ED ø 8mm thickness 0.5mm brass Qty 20 pcs for thread M4			
	<b>GEV No.</b>	521129	<b>Ref. No.</b>	—
<b>description</b>	nut thread M10 H 6mm SS WS 17 Qty 1 pcs DIN/ISO DIN 439			
	<b>GEV No.</b>	560111	<b>Ref. No.</b>	—
<b>description</b>	plain washer ID ø 4.3mm ED ø 9mm thickness 0.8mm SS Qty 20 pcs DIN 125A for thread M4			
	<b>GEV No.</b>	560131	<b>Ref. No.</b>	—
<b>description</b>	hexagonal nut thread M4 H 3.2mm WS 7 SS DIN/ISO DIN 934 / ISO 4032/8673 Qty 20 pcs			

## heating elements for convection



<b>GEV No.</b>	418345	<b>Ref. No.</b>	3710004
<b>description</b>	heating element 1600W 230V heating circuits 1 ID ø 178mm ED ø 191mm L 250mm H 40mm L1 50mm W1 32mm H1 16mm H2 24mm flange length 70mm flange width 22mm hole distance 56mm connection male faston 6.3mm tube ø 6.3mm convection heating element hole ø 5mm rectangular flange		

accessories for 418345



<b>GEV No.</b>	510368	<b>Ref. No.</b>	—
<b>description</b>	gasket L 70mm W 23.5mm hole ø 5mm hole distance 56mm FIBER thickness 2mm for heating element		



<b>GEV No.</b>	416030	<b>Ref. No.</b>	011482-01 011482-01R 019522-00 019522-00R
----------------	--------	-----------------	--

<b>description</b>	heating element 1900W 230V heating circuits 1 ID ø 175mm ED ø 192mm L 255mm H 42mm L1 47mm W1 30mm H1 16mm H2 26mm flange length 70mm flange width 22mm hole distance 56mm connection male faston 6.3mm tube ø 6.5mm convection heating element mounting thread M4 rectangular flange with thread bolt		
--------------------	--	--	--

spare parts for 416030





<b>GEV No.</b>	510368	<b>Ref. No.</b>	—
<b>description</b>	gasket L 70mm W 23.5mm hole ø 5mm hole distance 56mm FIBER thickness 2mm for heating element		



Зип Общепит

vsezip.ru

+7(812)987-08-81

 <p>1</p>			
<b>GEV No.</b>	415966	<b>Ref. No.</b>	RIC0001835
<b>description</b>	heating element 2500W 230V heating circuits 1 ID ø 176mm ED ø 188mm L 210mm H 28mm L1 22mm W1 30mm H1 3mm H2 25mm flange length 70mm flange width 22mm hole distance 56mm connection male faston 6.3mm tube ø 6.3mm convection heating element hole ø 5mm rectangular flange		
<b>For models:</b>	ME066-03-010, ME066-03-013, ME103-03-013XL, ME106-03-010XL, ME106-03-013		
<b>spare parts for</b>	415966		
	<b>GEV No.</b>	510368	<b>Ref. No.</b> —
<b>accessories for</b>	415966		
	<b>GEV No.</b>	510368	<b>Ref. No.</b> —
	gasket L 70mm W 23.5mm hole ø 5mm hole distance 56mm FIBER thickness 2mm for heating element		

 <p>1</p>			
<b>GEV No.</b>	419014	<b>Ref. No.</b>	011482-00-R
<b>description</b>	heating element 2700W 230V heating circuits 1 ID ø 179mm ED ø 192mm L 247mm H 34mm L1 50mm W1 30mm H1 8mm H2 25mm flange length 70mm flange width 23mm hole distance 56mm tube ø 6.3mm mounting thread M4 mounting distance 56mm		

radiation heaters

1-circuit

 <p>1</p>			
<b>GEV No.</b>	490113	<b>Ref. No.</b>	RIC0001295
<b>description</b>	radiation heater ø 200mm 1800W 230V heating circuits 1 energy regulation with temperature signalization with ribbon heater connections 2+2 connection type male faston 6.3mm CERAMASPEED		
<b>For models:</b>	ME046-03-000V, ME066-03-000V		

 <p>2-circuit</p>			
<b>GEV No.</b>	490139	<b>Ref. No.</b>	RIC0001294
<b>description</b>	radiation heater ø 250mm 2500W 230V heating circuits 2 energy regulation with temperature signalization partial power 1000W with ribbon heater connections 3+2 connection type male faston 6.3mm EGO		
<b>For models:</b>	ME046-03-000V, ME066-03-000V		

foil heating elements

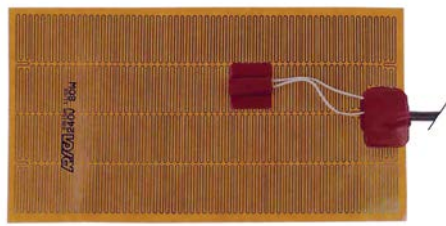
 <p>1</p>			
<b>GEV No.</b>	416416	<b>Ref. No.</b>	01233602R
<b>description</b>	foil heating element L 240mm W 130mm 80W 230V with temperature limiter 80°C t.max.°C plastic cable length 1270mm thickness 0.5mm connection cable		

 <p>1</p>			
<b>GEV No.</b>	416315	<b>Ref. No.</b>	01233501R 0123500R
<b>description</b>	heater mat L 470mm W 65mm 87W 230V with temperature limiter t.max. 80°C plastic cable length 3500mm		

 <p>1</p>			
<b>GEV No.</b>	416314	<b>Ref. No.</b>	01943001R
<b>description</b>	heating element 110W 230V cable length 2500mm		

accessories

retaining rings

 <p>1</p>			
<b>GEV No.</b>	510244	<b>Ref. No.</b>	RTMIN00283
<b>description</b>	retaining ring shaft ø 60mm thickness 2mm steel DIN 471		
<b>For models:</b>	ME046-03-004, ME066-03-007		



Зип.Общепит

vsezip.ru

With rad used edge

for domestic and commercial kitchens

+7(812)987-08-81

## sealing washers

## O-rings

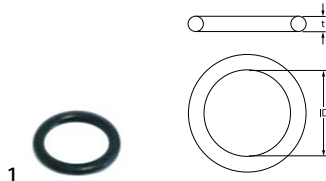

1

<b>GEV No.</b>	510893	<b>Ref. No.</b>	456015
<b>description</b>	O-ring EPDM thickness 2.62mm ID $\varnothing$ 9.92mm Qty 1 pcs		
<b>For models:</b>	D500LS, D501LS		

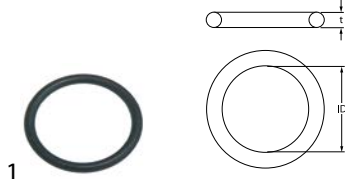

1

<b>GEV No.</b>	510408	<b>Ref. No.</b>	456002 REB456002
<b>description</b>	O-ring EPDM thickness 5.34mm ID $\varnothing$ 47mm Qty 1 pcs		
<b>For models:</b>	D500LS, D501LS, LB03100000, LB03300000, LP05500010		

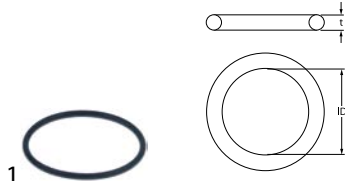

1

<b>GEV No.</b>	510243	<b>Ref. No.</b>	RTCU700565
<b>description</b>	O-ring Viton thickness 3.53mm ID $\varnothing$ 55.56mm Qty 1 pcs		
<b>For models:</b>	ME046-03-004, ME066-03-007		

## protection caps



1

<b>GEV No.</b>	510093	<b>Ref. No.</b>	69870
<b>description</b>	protection cap		
<b>For models:</b>	D500LS, D501LS		



1

<b>GEV No.</b>	520876	<b>Ref. No.</b>	463007
<b>description</b>	protection cap for heating element $\varnothing$ 11.5mm H 32mm W 25mm plastic		
<b>For models:</b>	D500LS, D501LS		

## round

With rad used edge

for domestic and commercial kitchens



1

<b>GEV No.</b>	490012	<b>Ref. No.</b>	RTCU700087
<b>description</b>	hot plate $\varnothing$ 145mm 1500W 230V connection 4 screw clamps with 8mm spill ring		
<b>For models:</b>	ME046-03-000, ME066-03-000, ME066-03-013, ME103-03-013XL, ME106-03-000, ME106-03-013		



1

<b>GEV No.</b>	490020	<b>Ref. No.</b>	RTCU700086
<b>description</b>	hot plate $\varnothing$ 220mm 2600W 230V connection 4 screw clamps with 8mm spill ring		
<b>For models:</b>	ME046-03-000, ME066-03-000, ME066-03-013, ME103-03-013XL, ME106-03-000, ME106-03-013		

**accessories for** 490020

<b>GEV No.</b>	550796	<b>Ref. No.</b>	—
----------------	--------	-----------------	---

fixing plate for hot plate  $\varnothing$ 220mm

## accessories

## miscellaneous

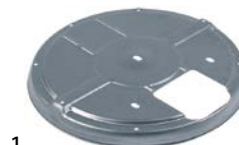

1

<b>GEV No.</b>	490111	<b>Ref. No.</b>	RTCU700083
<b>description</b>	cover for hot plate $\varnothing$ 237mm		
<b>For models:</b>	ME046-03-000, ME066-03-000, ME066-03-013, ME103-03-013XL, ME106-03-000, ME106-03-013		





## energy regulators

### EGO

#### 1-circuit



<b>GEV No.</b>	380015	<b>Ref. No.</b>	RTCU800066
<b>description</b>	energy regulator 230V 13A single-circuit turn direction right shaft ø 6x4.6mm shaft L 23mm mounting thread M4 power release 6-100% no. 50.57021.010		
<b>For models:</b>	ME046-03-005		



<b>GEV No.</b>	380019	<b>Ref. No.</b>	RIC0001299
<b>description</b>	energy regulator 240V 13A single-circuit turn direction right shaft ø 6x4.6mm shaft L 23mm mounting thread M4 power release 6-100% no. 50.57071.010		
<b>For models:</b>	ME046-03-000V, ME066-03-000V		

#### 2-circuit



<b>GEV No.</b>	380024	<b>Ref. No.</b>	RIC0001010
<b>description</b>	energy regulator 240V 13A turn direction right shaft ø 6x4.6mm shaft L 36mm mounting thread M4 no. 50.67079.601 with operation switch 1-pole		
<b>For models:</b>	ME046-03-000V, ME066-03-000V		

## thermostats

### bi-metal thermostats

#### safety bi-metal thermostats



<b>GEV No.</b>	390233	<b>Ref. No.</b>	236039
<b>description</b>	bi-metal safety thermostat hole distance 24mm switch-off temp. 110°C 1NC 1-pole 16A connection F6.3 2 hole fixing without holder		
<b>For models:</b>	D501LS		
<b>accessories for</b>	390233		



<b>GEV No.</b>	504736	<b>Ref. No.</b>	—
bracket for contact thermostat			

<b>accessories for</b>	390233	<b>GEV No.</b>	550388	<b>Ref. No.</b>	—
bracket for contact thermostat mounting distance 24.5mm mounting ø 3.3					



<b>GEV No.</b>	390526	<b>Ref. No.</b>	012728-00 01272800R
<b>description</b>	bi-metal safety thermostat hole distance mm switch-off temp. 25°C 1NO 1-pole AV connection F6.3		



<b>GEV No.</b>	390959	<b>Ref. No.</b>	2LT135
<b>description</b>	bi-metal safety thermostat switch-off temp. 60°C 1-pole connection F6.3		
<b>For models:</b>	KL030-10-000W		



<b>GEV No.</b>	390318	<b>Ref. No.</b>	236047
<b>description</b>	bi-metal safety thermostat switch-off temp. 95°C 1-pole 2 hole fixing		
<b>For models:</b>	D500LS, D501LS		

### control and safety thermostats

#### EGO

#### control thermostats

#### 51\_ series



<b>GEV No.</b>	375347	<b>Ref. No.</b>	RTCU700609
<b>description</b>	thermostat t.max. 175°C temperature range 95-175°C 1-pole capillary pipe isolated mm gland nut shaft ø 6x4.6mm		
<b>For models:</b>	ME046-03-004, ME066-03-007		

Зип-Общепит

vsezip.ru

+7(812)987-08-81



1

<b>GEV No.</b>	375334	<b>Ref. No.</b>	RTBF800152
<b>description</b>	thermostat t.max. 85°C temperature range 30-85°C 1-pole 1NO 16A probe ø 6mm probe L 130mm capillary pipe 900mm capillary pipe isolated 900mm gland nut shaft ø 6x4.6mm shaft L 23mm shaft position upper rotation 270°		
<b>For models:</b>	ME046-03-003		



1

<b>GEV No.</b>	375385	<b>Ref. No.</b>	53401031820
<b>description</b>	thermostat t.max. 180°C temperature range 100-180°C 3-pole 3NO 16A probe ø 6mm probe L 131mm capillary pipe 2000mm capillary pipe isolated 1800mm gland nut shaft ø 6x4.6mm shaft L 23mm shaft position upper rotation 270°		

55.10/19\_series

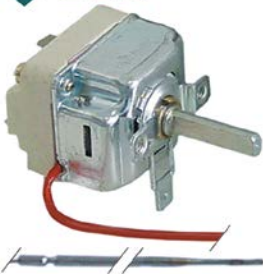

1

<b>GEV No.</b>	375354	<b>Ref. No.</b>	RTCU600186
<b>description</b>	thermostat t.max. 270°C temperature range 50-270°C 1-pole 1NO 16A probe ø 3mm probe L 219mm capillary pipe 900mm capillary pipe isolated 900mm gland nut shaft ø 6x4.6mm shaft L 23mm shaft position upper rotation 270°		
<b>For models:</b>	ME066-03-010, ME066-03-013, ME103-03-013XL, ME106-03-010XL, ME106-03-013		

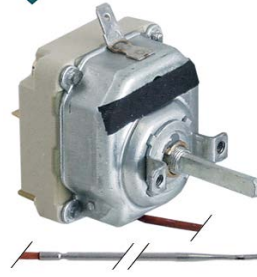

1

<b>GEV No.</b>	375355	<b>Ref. No.</b>	RTCU600067
<b>description</b>	thermostat t.max. 300°C temperature range 50-300°C 3-pole 3NO 16A probe ø 3mm probe L 219mm capillary pipe 900mm capillary pipe isolated 900mm gland nut shaft ø 6x4.6mm shaft L 23mm shaft position upper rotation 270°		
<b>For models:</b>	ME046-03-001, ME046-03-002, ME046-13-001, ME046-13-002, ME066-03-003, ME066-03-004, ME066-03-015, ME066-13-003, ME106-13-003		

safety thermostats

55.10/19\_series

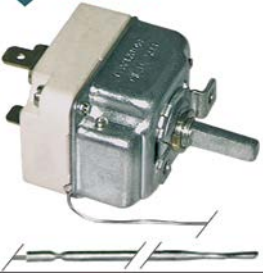

1

<b>GEV No.</b>	375232	<b>Ref. No.</b>	RTCU700085
<b>description</b>	thermostat t.max. 320°C temperature range 55-320°C 1-pole capillary pipe isolatedmm gland nut		
<b>For models:</b>	MG099-03-012, MG099-03-012M, MG099-13-012I, MG099-13-012IM		



1

<b>GEV No.</b>	375339	<b>Ref. No.</b>	RTBF900094
<b>description</b>	safety thermostat switch-off temp. 225°C 1-pole 0.5A probe ø 6mm probe L 133mm capillary pipe 870mm capillary pipe isolatedmm gland nut M10x1 probe		
<b>For models:</b>	MG046-03-004, MG066-03-007		

<b>accessories for</b>	375339			
	<b>GEV No.</b>	551083	<b>Ref. No.</b>	—
	cap for safety thermostat thread M8x1			



Зип Общепит

vsezip.ru

+7(812)987-08-81



<b>GEV No.</b>	375656	<b>Ref. No.</b>	RTBF800076
<b>description</b>	safety thermostat switch-off temp. 360°C 1-pole 0.5A probe ø 3.1mm probe L 201mm capillary pipe 900mm capillary pipe isolated 870mm gland nut probe SS		
<b>For models:</b>	MG099-03-012, MG099-03-012M, MG099-13-012I, MG099-13-012IM		



<b>GEV No.</b>	375228	<b>Ref. No.</b>	RTCU800152
<b>description</b>	safety thermostat switch-off temp. 350°C 3-pole 20A probe ø 3mm probe L 188mm capillary pipe 900mm capillary pipe isolated 900mm gland nut probe SS		
<b>For models:</b>	ME066-03-006		

55.32\_series





<b>GEV No.</b>	375333	<b>Ref. No.</b>	RTCP900074
<b>description</b>	safety thermostat switch-off temp. 135°C 3-pole 20A probe ø 3.1mm probe L 225mm capillary pipe 890mm capillary pipe isolated 890mm gland nut probe SS		
<b>For models:</b>	LX7EC4, ME066-03-008		





<b>GEV No.</b>	375258	<b>Ref. No.</b>	RTBF800164
<b>description</b>	safety thermostat switch-off temp. 232°C 3-pole 20A probe ø 6mm probe L 94mm capillary pipe 900mm capillary pipe isolated 670mm gland nut M10x1 probe SS		
<b>For models:</b>	ME046-03-004, ME066-03-007		

IMIT / TEMPOMATIC / ARTHERMO control thermostats

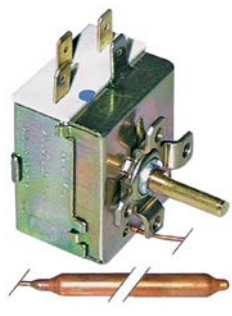

<b>GEV No.</b>	390008	<b>Ref. No.</b>	019310-00 01931000R
<b>description</b>	thermostat t.max. 210°C temperature range 64-210°C 1-pole 1CO 16A probe ø 5mm probe L 100mm capillary pipe 1000mm capillary pipe isolatedmm gland nut shaft L 19mm rotation 270° probe material copper		
<b>accessories for</b>	390008		
	<b>GEV No.</b>	110102	<b>Ref. No.</b> —
	knob thermostat t.max. 210°C 40-210°C ø 42mm shaft ø 6x4.6mm shaft flat -135° black		



<b>GEV No.</b>	390006	<b>Ref. No.</b>	014688-00 01468800R
<b>description</b>	thermostat t.max. 86°C temperature range 0-86°C 1-pole 1CO 16A probe ø 6.5mm probe L 95mm capillary pipe 1500mm capillary pipe isolatedmm gland nut shaft ø 6x4.6mm shaft L 19mm rotation 270°		
<b>accessories for</b>	390006		
	<b>GEV No.</b>	110100	<b>Ref. No.</b> —
	knob thermostat t.max. 90°C 0-90°C ø 42mm shaft ø 6x4.6mm shaft flat -135° black		
	<b>GEV No.</b>	110105	<b>Ref. No.</b> —
	rosette knob ø 42mm ø 56mm zero mark		

Зип-Общепит  
refrigeration thermostatsuniversal without housing  
vsezip.ru



+7(812)987-08-81

CAEM

control thermostats



1

<b>GEV No.</b>	390672	<b>Ref. No.</b>	236042
<b>description</b>	thermostat t.max. 53°C temperature range fixed 53°C 1-pole 1CO 16A probe ø 9.5mm probe L 30mm capillary pipe 600mm capillary pipe isolated 540mm gland nut shaft Lmm screw-in probe probe thread M14x1		
<b>For models:</b>	D500LS, D501LS		
<b>spare parts for</b>	390672		
	<b>GEV No.</b>	510417	<b>Ref. No.</b> —
	flat gasket fibre ED ø 20mm ID ø 14mm thickness 2mm Qty 1 pcs		
	<b>GEV No.</b>	550261	<b>Ref. No.</b> —
	nut thread M14x1 H 4mm WS 19 SS Qty 1 pcs		



1

<b>GEV No.</b>	390686	<b>Ref. No.</b>	236043
<b>description</b>	thermostat t.max. 83°C temperature range°C 1-pole 1CO 20A probe ø 6mm probe L 90mm capillary pipe 630mm capillary pipe isolated 550mm gland nut shaft ømm shaft Lmm shaft position rotation 270° probe material copper		
<b>For models:</b>	D500LS, D501LS		

PRODIGY / FIRT

control thermostats



1

<b>GEV No.</b>	390723	<b>Ref. No.</b>	012727-00
<b>description</b>	thermostat PRODIGY temperature range -35 up to +35°C probe ø 6mm probe L 110mm capillary pipe 1500mm type TR/711-N		
<b>accessories for</b>	390723		
	<b>GEV No.</b>	110305	<b>Ref. No.</b> —
	knob thermostat t.max. 35°C temperature range -35 up to +35°C ø 45mm shaft ø 6x4.6mm shaft flat inclined rotation 270° white		

universal without housing



1

<b>GEV No.</b>	390534	<b>Ref. No.</b>	012727-00 01272700R
<b>description</b>	thermostat temperature range -35 up to +35°C probe ø6x110mm capillary pipe 1800mm PRODIGY		
<b>accessories for</b>	390534		
	<b>GEV No.</b>	110305	<b>Ref. No.</b> —
	knob thermostat t.max. 35°C temperature range -35 up to +35°C ø 45mm shaft ø 6x4.6mm shaft flat inclined rotation 270° white		

RANCO

K22 series

RANCO



1

<b>GEV No.</b>	390207	<b>Ref. No.</b>	1LT020
<b>description</b>	thermostat RANCO type K22L2030 probe ø 2mm probe Lmm capillary pipe 2000mm temperature range -13 up to -4°C		
<b>For models:</b>	KL030-10-000A		

K50 series

RANCO



1

<b>GEV No.</b>	390271	<b>Ref. No.</b>	013475-00 01347500R
<b>description</b>	thermostat RANCO type K50L3078 probe ømm probe Lmm capillary pipe 2000mm temperature range -7 up to -3°C		





Зип Общепит  
vsezip.ru

+7(812)987-08-81

			
<b>GEV No.</b>	390272	<b>Ref. No.</b>	013477-00 013477-00R
<b>description</b>	thermostat RANCO type K50P1117 probe ømm probe Lmm capillary pipe 2000mm temperature range -32 up to -12°C		

			
<b>GEV No.</b>	390273	<b>Ref. No.</b>	013471-00 01347100R
<b>description</b>	thermostat RANCO type K50L3194 capillary pipe 1870mm temperature range +1 up to +3°C probe ø10x40mm		

			
<b>GEV No.</b>	345386	<b>Ref. No.</b>	018153-00 01815300R
<b>description</b>	rocker switch mounting measurements 30x11mm yellow 1NO 250V 16A time/main switch connection male faston 6.3mm ambient temperature max. 90°C protection IP40		

			
<b>GEV No.</b>	345384	<b>Ref. No.</b>	013519-00 01351900R
<b>description</b>	rocker switch mounting measurements 30x11mm yellow 1NO/indicator light 250V 16A 0-lighting connection male faston 6.3mm ambient temperature max. 90°C protection IP40		

			
<b>GEV No.</b>	345383	<b>Ref. No.</b>	013474-00 01347400R
<b>description</b>	rocker switch mounting measurements 30x11mm yellow 1NO/indicator light 250V 16A fan connection male faston 6.3mm ambient temperature max. 90°C protection IP40		

accessories

connecting bows

			
<b>GEV No.</b>	550060	<b>Ref. No.</b>	RTBF900037
<b>description</b>	connecting bow long for thermostat Qty 1 pcs		
<b>For models:</b>	ME066-03-015		



switches and momentary switches

rocker/momentary rocker switches

<p>30x11mm</p> 			
<b>GEV No.</b>	345381	<b>Ref. No.</b>	017462-00 01746200R
<b>description</b>	rocker switch mounting measurements 30x11mm green 1NO/indicator light 24V 16A connection male faston 6.3mm		

			
<b>GEV No.</b>	345382	<b>Ref. No.</b>	013473-00 01347300R
<b>description</b>	rocker switch mounting measurements 30x11mm green 1NO/indicator light 250V 16A 0-I connection male faston 6.3mm ambient temperature max. 85°C protection IP40		

30x22mm

			
<b>GEV No.</b>	301003	<b>Ref. No.</b>	01273100R
<b>description</b>	rocker switch mounting measurements 30x22mm green 2NO 250V 16A illuminated 0-I connection male faston 6.3mm ambient temperature max. 125/55°C protection IP65		
<b>accessories for</b>	301003		
	<b>GEV No.</b>	301036	<b>Ref. No.</b> —
	protective cover internal size 30x22mm for rocker switch mounting measurementsmm		

push/momentary push switches

20.6x16.4mm

			
<b>GEV No.</b>	346595	<b>Ref. No.</b>	RTCU600189
<b>description</b>	momentary push switch mounting ø 20.6x16.4mm black 1NO 250V 16A ignition connection male faston 6.3mm ambient temperature max. 150/75°C protection IP40		
<b>For models:</b>	ME066-03-010, ME106-03-010XL, MG066-03-010, MG106-03-010, MG106-03-010XL		



Зип.Общепит

vsezip.ru

+7(812)987-08-81

			
1			
<b>GEV No.</b>	345663	<b>Ref. No.</b>	RTCU600187
<b>description</b>	push switch mounting measurements 20.6x16.4mm black 1NO 250V 16A lamp connection male faston 6.3mm ambient temperature max. 150°C protection IP40		
<b>For models:</b>	ME106-03-010XL, MG066-03-010, MG106-03-010, MG106-03-010XL		

			
1			
<b>GEV No.</b>	345667	<b>Ref. No.</b>	RTCU600188
<b>description</b>	push switch mounting ø 20.6x16.4mm black 1NO 250V 16A heating connection male faston 6.3mm ambient temperature max. 150°C protection IP40		
<b>For models:</b>	ME106-03-010XL, MG066-03-010, MG106-03-010, MG106-03-010XL		

## microswitches

## lever actuated

			
Image not available			
1			
<b>GEV No.</b>	345376	<b>Ref. No.</b>	01273000R
<b>description</b>	microswitch		

			
1			
<b>GEV No.</b>	346182	<b>Ref. No.</b>	9353445500
<b>description</b>	microswitch with lever 250V 10A 1CO connection male faston ambient temperature max. 85°C		
<b>For models:</b>	MG066-03-010, MG106-03-010, MG106-03-010XL		

			
1			
<b>GEV No.</b>	345742	<b>Ref. No.</b>	RTBF900277
<b>description</b>	microswitch with lever 250V 16A 1CO connection male faston 6.3mm L 55mm ambient temperature max. 120°C mounting distance 22mm actuating force: 75g lever length 46mm		
<b>For models:</b>	ME046-03-004, ME066-03-007		

			
roller lever actuated			
microswitches			
1			
<b>GEV No.</b>	348144	<b>Ref. No.</b>	25001301 25001311
<b>description</b>	microswitch 250V 8A 1CO connection F6.3 actuating force: 300g		

## roller actuated

			
roller 0°			
1			
<b>GEV No.</b>	346370	<b>Ref. No.</b>	RTBF800113
<b>description</b>	microswitch with roller plunger 230V 16A 1CO connection screw L1 49mm ambient temperature max. 125°C thread L 14mm thread M10 mounting distance 25mm actuating force: 300g type MV15-2		
<b>For models:</b>	MG099-03-012, MG099-03-012M, MG099-13-012I, MG099-13-012IM		

## system switches (ROLD)

			
1			
<b>GEV No.</b>	345606	<b>Ref. No.</b>	226071
<b>description</b>	momentary switch unit 2CO 250V 16A connection male faston 6.3mm		
<b>For models:</b>	D500LS, D501LS		

			
1			
<b>GEV No.</b>	347517	<b>Ref. No.</b>	227060
<b>description</b>	push button ø 21mm silver edition		
<b>For models:</b>	D500LS, D501LS		

			
1			
<b>GEV No.</b>	345605	<b>Ref. No.</b>	208010
<b>description</b>	switch 2CO 250V 16A connection male faston 6.3mm		
<b>For models:</b>	D500LS, D501LS		



cam switches

on/off

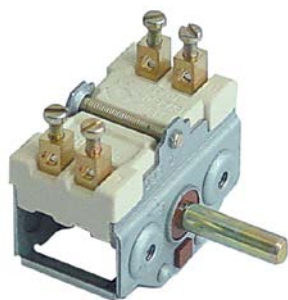

1

<b>GEV No.</b>	300151	<b>Ref. No.</b>	RTCU700212
<b>description</b>	cam switch 2 operating positions 2NO sequence 0-1 16A shaft ø 6x4.6mm shaft L 23mm connection screw ceramic		
<b>For models:</b>	ME046-03-003, ME066-03-006, MG099-03-012, MG099-03-012M, MG099-13-012I, MG099-13-012IM		

4-position





1

<b>GEV No.</b>	300104	<b>Ref. No.</b>	RTCP900036
<b>description</b>	cam switch 4 operating positions 3NO/1CO sequence 0-1-2-3 32A shaft ø 6x4.6mm shaft L 23mm connection screw ceramic		
<b>For models:</b>	LX7EC4, ME066-03-008		

7-position



1

<b>GEV No.</b>	300025	<b>Ref. No.</b>	RTCU700078
<b>description</b>	cam switch 7 operating positions 1NO/2CO sequence 0-1-2-3-4-5-6 16A shaft ø 6x4.6mm shaft L 23mm connection screw 7-position ceramic		
<b>For models:</b>	ME046-03-000, ME066-03-000, ME066-03-013, ME103-03-013XL, ME106-03-000, ME106-03-013		
<b>accessories for</b>	300025		
	<b>GEV No.</b>	112172	<b>Ref. No.</b> —
	knob universal ø 70mm black without adaptor/dial plate		
	<b>GEV No.</b>	112213	<b>Ref. No.</b> —
	knob dial plate silver switch 7-position t.max.°C ED ø 63mm ID ø 45.5mm		
	<b>GEV No.</b>	112311	<b>Ref. No.</b> —
	knob adapter shaft ø 6x4.6mm L 0mm with spring		

Зип Общепит

vsezip.ru

+7(812)987-08-81



1

<b>GEV No.</b>	300106	<b>Ref. No.</b>	RTCU800051
<b>description</b>	cam switch 7 operating positions 1NO/2CO sequence 0-1-2-3-4-5-6 32A shaft ø 6x4.6mm shaft L 23mm connection screw 7-position shaft flat upper		

operation switches



1

<b>GEV No.</b>	300080	<b>Ref. No.</b>	RTBF900007
<b>description</b>	cam switch 2 operating positions 4NO 16A sequence 0-1 shaft ø 6x4.6mm shaft L 23mm connection screw operation switch ceramic ambient temperature max. 150°C		
<b>For models:</b>	ME046-03-001, ME046-03-002, ME046-13-001, ME046-13-002, ME066-03-003, ME066-03-004, ME066-03-015, ME066-13-003, ME106-13-003		

<b>accessories for</b>	300080		
	<b>GEV No.</b>	551456	<b>Ref. No.</b> —
	gasket for switch ED ø 14mm ID ø 2.5mm thickness 3.5mm white		

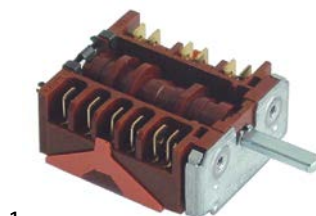

1

<b>GEV No.</b>	300157	<b>Ref. No.</b>	RTCU600185
<b>description</b>	cam switch 4 operating positions operation switch sequence 0-1-2-3 shaft ø 6x4.6mm connection male faston 3-pole ambient temperature max. 300°C		
<b>For models:</b>	ME066-03-010, ME066-03-013, ME103-03-013XL, ME106-03-010XL, ME106-03-013		



E-G-O



1

<b>GEV No.</b>	300091	<b>Ref. No.</b>	RTCU900110
<b>description</b>	operation switch EGO 2 operating positions 2NO 16A sequence 0-1 shaft $\varnothing$ 6x4.6mm shaft L 23mm connection screw ceramic		
<b>For models:</b>	ME046-03-004		

## magnetic switches

36x13mm



1

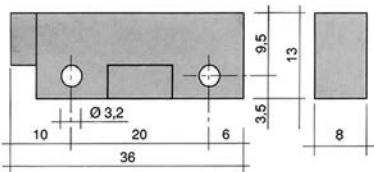

<b>GEV No.</b>	345118 <sup>1</sup>	<b>Ref. No.</b>	80871
<b>description</b>	magnetic switch L 36mm W 13mm 1NO 250V 1A P max. 50W connection cable length 980mm		
<b>For models:</b>	D500LS, D501LS		
<b>accessories for</b>	345118		
	<b>GEV No.</b>	345399	<b>Ref. No.</b> —
	magnet $\varnothing$ 3.3mm L 40mm H 8mm W 13mm hole distance 30mm M3		

<sup>1</sup>with coded connector

## accessories

## magnets



1

<b>GEV No.</b>	346953	<b>Ref. No.</b>	999108
<b>description</b>	magnet $\varnothing$ 3.3mm L 23mm H 17mm W 18mm M6 hole $\varnothing$ 6.5mm		
<b>For models:</b>	D500LS, D501LS		

Зип.Общепит  
control equipment

## TELEMECANIQUE (EFA)



vsezip.ru

XB2 series

+7(812)987-08-81



1

<b>GEV No.</b>	345412	<b>Ref. No.</b>	RTBF800125
<b>description</b>	contact block with holder 1NO		
<b>For models:</b>	MG099-03-012, MG099-13-012I		
<b>spare parts for</b>	345412		
	<b>GEV No.</b>	345220	<b>Ref. No.</b> —
	contact block EFA ZB2BE101 1NO max 230V 10(6)A black		
	<b>GEV No.</b>	345221	<b>Ref. No.</b> —
	contact block EFA ZB2BE102 1NC max 230V 10(6)A black		
	<b>GEV No.</b>	347526	<b>Ref. No.</b> —
	contact block holder for XB2		

## lamps

## indicator lights

## indicator lights (complete)

 $\varnothing$  6mm

1

<b>GEV No.</b>	359005	<b>Ref. No.</b>	216025
<b>description</b>	indicator light $\varnothing$ 6mm 230V yellow cable length 400mm		
<b>For models:</b>	D500LS, D501LS		

 $\varnothing$  10mm

## with plug-in socket



1

<b>GEV No.</b>	359140	<b>Ref. No.</b>	216018
<b>description</b>	indicator light $\varnothing$ 10mm yellow 230V connection male faston 6.3mm Qty 1 pcs		









Зип-Общепит



vsezip.ru

+7(812)987-08-81

ø12mm			
with screw socket			
			
1			
<b>GEV No.</b>	359291	<b>Ref. No.</b>	011486-00 01148600R
<b>description</b>	indicator light ø 12mm 400V green connection male faston 6.3mm		

30x11mm			
			
1			
<b>GEV No.</b>	359058	<b>Ref. No.</b>	013472-00 01347200R RIC0002907
<b>description</b>	indicator light mounting measurements 30x11mm 230V green		

ø13mm			
with screw socket			
			
1			
<b>GEV No.</b>	359145	<b>Ref. No.</b>	166465
<b>description</b>	indicator light ø 13mm 230V green t.max. 120°C		
<b>For models:</b>	LX7EC4		
<b>accessories for</b>	359145		
	<b>GEV No.</b>	510302	<b>Ref. No.</b> —
	O-ring EPDM ID ø 12.42mm thickness 1.78mm Qty 1 pcs		
	<b>GEV No.</b>	511505	<b>Ref. No.</b> —
	O-ring EPDM thickness 1.78mm ID ø 12.42mm Qty 10 pcs		

30x22mm			
			
1			
<b>GEV No.</b>	359157	<b>Ref. No.</b>	012732-00 01273200R
<b>description</b>	indicator light mounting measurements 30x22mm 230V green connection male faston 6.3mm temp.-resist. 125/55°C type RL2		
<b>accessories for</b>	359157		
	<b>GEV No.</b>	301036	<b>Ref. No.</b> —
	protective cover internal size 30x22mm for rocker switch mounting measurementsmm		

with plug-in socket			
			
1			
<b>GEV No.</b>	359142	<b>Ref. No.</b>	RTC900290
<b>description</b>	indicator light ø 13mm green 230V connection male faston 6.3mm temp.-resist. 120°C Qty 1 pcs		
<b>For models:</b>	ME046-03-000, ME046-03-000V, ME046-03-001, ME046-03-002, ME046-03-003, ME046-03-004, ME046-03-005, ME046-13-001, ME046-13-002, ME066-03-000, ME066-03-000V, ME066-03-003, ME066-03-004, ME066-03-006, ME066-03-007, ME066-03-008, ME066-03-010, ME066-03-013, ME066-03-015, ME066-13-003, ME103-03-013XL, ME106-03-000, ME106-03-010XL, ME106-03-013, ME106-13-003, MG066-03-010, MG099-03-012, MG099-03-012M, MG099-13-012I, MG099-13-012IM, MG106-03-010, MG106-03-010XL		

screw-on/push-on fit

light bulbs			
for ovens			
			
1			
<b>GEV No.</b>	359610	<b>Ref. No.</b>	9303310100 RIC0002592
<b>description</b>	light bulb t.max. 300°C socket E14 15W 230V ø 22mm L 47mm lens L 20mm for oven lamp type Philips		
<b>For models:</b>	ME066-03-010, ME066-03-013, ME103-03-013XL, ME106-03-010XL, ME106-03-013, MG066-03-010, MG106-03-010, MG106-03-010XL		

			
1			
<b>GEV No.</b>	359143	<b>Ref. No.</b>	RTC900072
<b>description</b>	indicator light ø 13mm yellow 230V connection male faston 6.3mm temp.-resist. 120°C Qty 1 pcs		
<b>For models:</b>	ME046-03-001, ME046-03-002, ME046-03-003, ME046-03-004, ME046-13-001, ME046-13-002, ME066-03-003, ME066-03-004, ME066-03-006, ME066-03-007, ME066-03-010, ME066-03-013, ME066-03-015, ME066-13-003, ME103-03-013XL, ME106-03-010XL, ME106-03-013, ME106-13-003, MG099-03-012, MG099-03-012M, MG099-13-012I, MG099-13-012IM		

electric components



## Зип.Общепит

defrost timers



## oven lamps

## universal oven lamps

mounting diameter 35.5mm



1

<b>GEV No.</b>	359718	<b>Ref. No.</b>	9303310000 RIC0002549
<b>description</b>	oven lamp mounting $\varnothing$ 35.5mm 230V 15W socket E14 temp.-resist. 300°C connection male faston 6.3mm hard glas		
<b>For models:</b>	ME066-03-010, ME066-03-013, ME103-03-013XL, ME106-03-010XL, ME106-03-013, MG066-03-010, MG106-03-010, MG106-03-010XL		
<b>spare parts for</b>	359718		
	<b>GEV No.</b>	359701	<b>Ref. No.</b> —
	lamp socket socket E14 220-230V mounting $\varnothing$ 35.5mm connection male faston 6.3mm 15W		
	<b>GEV No.</b>	359740	<b>Ref. No.</b> —
	light bulb t.max. 300°C socket E14 15W 230V $\varnothing$ 22mm L 48mm lens L 20mm for oven lamp IMPORT		

## lamps

## light bulbs



1

<b>GEV No.</b>	359610	<b>Ref. No.</b>	9303310100 RIC0002592
<b>description</b>	light bulb t.max. 300°C socket E14 15W 230V $\varnothing$ 22mm L 47mm lens L 20mm for oven lamp type Philips		
<b>For models:</b>	ME066-03-010, ME066-03-013, ME103-03-013XL, ME106-03-010XL, ME106-03-013, MG066-03-010, MG106-03-010, MG106-03-010XL		

## timers

## programme timers



1

<b>GEV No.</b>	360051	<b>Ref. No.</b>	1LT017
<b>description</b>	timer FIBER P36 engines 1 chambers 2 operation time 15min 230V shaft $\varnothing$ mm shaft Lmm manuf. no. P365JR2J717 motor type M51B-J0R6400		
<b>spare parts for</b>	360051		
	<b>GEV No.</b>	360673	<b>Ref. No.</b> —
	motor kit pinion $\varnothing$ 6.8mm teeth 15 230V voltage AC 50/60Hz turn direction clockwise motor $\varnothing$ 48mm H 18.5mm motor type UDS-40NE1RNZ165 cable length 150mm with holder		

BIGATTI  
vsezip.ru

1

<b>GEV No.</b>	360053	<b>Ref. No.</b>	013467-00 01346700R
<b>description</b>	defrost timer BIGATTI type D94.44 defrosting interval 4x per 24h defrosting time 10min fan delaymin 230V defr. funct. every 12h for 20 min.		



1

<b>GEV No.</b>	360058	<b>Ref. No.</b>	012720-01 01272001R
<b>description</b>	defrost timer type SB3.82 defrosting interval 1-12x in 24h defrosting time 2-54min fan delay 0-15min 230V defr. funct. 1-12x per 24h		

## CDC



1

<b>GEV No.</b>	360521	<b>Ref. No.</b>	013467-00
<b>description</b>	defrost timer CDC type 11901F defrosting interval 4x per 24h defrosting time 12min fan delaymin 230V 50-60Hz defr. funct. every 6h		



contactors

ISKRA (FANAL)

power contactors



1

<b>GEV No.</b>	380213	<b>Ref. No.</b>	019033-00 01903300R
<b>description</b>	power contactor resistive load 20A 230VAC (AC3/400V) 8.5A/5.5kW main contacts 3NO auxiliary contacts 1NO connection screw connection type Fanal DSL7 10 type ISKRA K07M 10		

LOVATO

power contactors



1

<b>GEV No.</b>	380888	<b>Ref. No.</b>	RTFOC00465
<b>description</b>	power contactor resistive load 20A 230VAC (AC3/400V) 12A/5.7kW main contacts 3NO auxiliary contacts 1NC connection screw connection type 11BG1201A230		
<b>For models:</b>	ME046-03-004, ME066-03-007		

relays

power relays

with bracket mounting



1

<b>GEV No.</b>	380312	<b>Ref. No.</b>	019032-00 01903200R
<b>description</b>	power relays FINDER 230VAC 10A 3CO connection male faston 4.8mm bracket mounting dimensions 52x32.2x36.5mm manuf. no. 60.63.8.230.0000		
<b>For models:</b>	LB03100000, LB03300000, LP05500010		

Зип Общепит

vsezip.ru

+7(812)987-08-81



1

<b>GEV No.</b>	380702	<b>Ref. No.</b>	229039 229040
<b>description</b>	power relays FINDER 230VAC 16A 3NO connection male faston 6.3mm flange dimensions 36x38x68mm manuf. no. 62.83.8.230.0300 230V		
<b>For models:</b>	D500LS, D501LS		

relay sockets

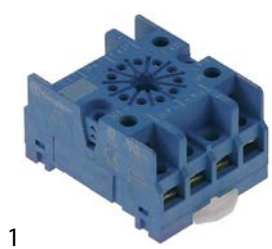

1

<b>GEV No.</b>	380667	<b>Ref. No.</b>	022031-00	
<b>description</b>	relay socket 11-pole dimensions 56x43x31mm 250V voltage AC 10A FINDER manuf. no. 90.27			
<b>accessories for</b>	380667			
	<b>GEV No.</b>	380805	<b>Ref. No.</b>	—
				support bracket

time relays

time relays



1

<b>GEV No.</b>	360172	<b>Ref. No.</b>	019028-00 01902800R	
<b>description</b>	time relay 2CO connection plug-in connection 100-240V 11-pole voltage AC 0.1s - 100h at 250V 5A			
<b>accessories for</b>	360172			
	<b>GEV No.</b>	360345	<b>Ref. No.</b>	—
				mounting frame for time relay for PM4H/LT4H
	<b>GEV No.</b>	380136	<b>Ref. No.</b>	—
				relay socket 11-pole connection plug-in connection round 11-pole dimensions 65x28x40mm 250V voltage AC 10A Italiana Relè manuf. no. ZVE11
	<b>GEV No.</b>	380667	<b>Ref. No.</b>	022031-00
				relay socket 11-pole dimensions 56x43x31mm 250V voltage AC 10A FINDER manuf. no. 90.27



+7(812)987-08-81

1 electric components

transformers

encapsulated transformers

with screw connection



1			
<b>GEV No.</b>	402016	<b>Ref. No.</b>	014687-00 01468700R
<b>description</b>	transformer 65VA		

PMA



1			
<b>GEV No.</b>	379054	<b>Ref. No.</b>	014675-00 01467500R
<b>description</b>	transformer primary 230VAC secondary 12VAC 3VA secondary 0.25A H 40mm L 45mm W 50mm connection screw 50/60Hz type 153/M		

electronic controllers

EKTRON

refrigeration controllers

built-in version



1			
<b>GEV No.</b>	402020	<b>Ref. No.</b>	014673-00 01467300R 014673-01 01467301R
<b>description</b>	electronic controller EKTRON type REK33-0020 mounting measurements 71x29mm 12V voltage AC/DC PTC relay outputs 3 NO-8A(4) NO-8A(4) NO-8A(4) PTC PTC built-in depth 71mm -50 up to +95°C display 3 digits		

refrigeration controllers



1			
<b>GEV No.</b>	402017	<b>Ref. No.</b>	019045-00 01904500R 019046-00 01904600R 019047-00 01904700R
<b>description</b>	electronic controller ELIWELL type EWPC974 mounting measurements 71x29mm		



1			
<b>GEV No.</b>	379645	<b>Ref. No.</b>	019497-00 024169-00
<b>description</b>	electronic controller ELIWELL type ID961 mounting measurements 71x29mm 230V voltage AC NTC/PTC relay outputs 1 relay -55 up to +150°C display 3½ digits compressor relay 15A		
<b>For models:</b>	SA100-00-000E		
<b>accessories for</b>	379645		
	<b>GEV No.</b>	379053	<b>Ref. No.</b> —
	temperature probe PTC 1kOhm cable PVC probe -50 up to +150°C cable -10 up to 100°C probe ø6x30mm cable length 3m without screw connection 2-wire		
	<b>GEV No.</b>	379064	<b>Ref. No.</b> 014674-00 01467400R 014674-01 01467401R
	temperature probe PTC 1kOhm cable silicone probe -50 up to +150°C cable -50 up to +180°C probe ø6x40mm cable length 3m without screw connection 2-wire		
	<b>GEV No.</b>	379161	<b>Ref. No.</b> —
	temperature probe NTC 10kOhm cable thermoplastic probe -40 up to +110°C cable -40 up to +110°C probe ø6x14mm cable length 3m without screw connection 2-wire		
	<b>GEV No.</b>	379782	<b>Ref. No.</b> —
	temperature probe PTC 1kOhm cable thermoplastic probe -50 up to +150°C cable -40 up to +110°C probe ø6x14mm cable length 3m 2-wire resistor 1kOhm		



LAE

refrigeration controllers

built-in version



1

<b>GEV No.</b>	378300	<b>Ref. No.</b>	025057-00R
<b>description</b>	electronic controller LAE mounting measurements 71x29mm 230V voltage AC NTC/PTC relay outputs 3 -50 to +120°C display 3 digits fan relay 7A 7A compressor relay 16A		



1

<b>GEV No.</b>	378420	<b>Ref. No.</b>	020518-01
<b>description</b>	electronic controller LAE type AT1-5AS2E-G mounting measurements 71x29mm 230V voltage AC NTC/PTC relay outputs 2 NO-16A(4) NO-7A(2) NTC/PTC front measurements 77x35mm built-in depth 70mm protection IP55 yes -50 to +120°C display 3 digits		
<b>accessories for</b>	378420		
	<b>GEV No.</b>	<b>Ref. No.</b>	025461-00
	temperature probe NTC 10kOhm cable TPE probe -40 up to +110°C cable -40 up to +110°C probe ø6x28mm cable length 2m cable colours grey 2-wire		



1

<b>GEV No.</b>	378184	<b>Ref. No.</b>	021226-00
<b>description</b>	electronic controller LAE type LCD32Q4E-C mounting measurements 149x30mm 230V voltage AC NTC relay outputs 4 NO-20A(6) NO-12A(4) NO-8A(3) CO-8A(3) NTC NTC DI DI front measurements 169x38mm built-in depth 78mm protection IP55 yes yes -30 up to +30°C display 3 digits		
<b>accessories for</b>	378184		
	<b>GEV No.</b>	<b>Ref. No.</b>	02128300 021283-00R
	temperature probe NTC 2kOhm cable thermoplastic probe -40 up to +110°C cable -40 up to +110°C probe ø6x35mm cable length 2m without screw connection 2-wire resistor 2kOhm		

Зип Общепит

vsezip.ru

+7(812)987-08-81



<b>GEV No.</b>	378260	<b>Ref. No.</b>	023382-00
<b>description</b>	electronic controller LAE type LD2-15B4E mounting measurements 71x29mm 230V voltage AC NTC relay outputs 3 relays yes yes -50 up to +80°C display 3 digits RoomTempIN yes DEF Relay 7A fan relay 7A compressor relay 16A		
<b>accessories for</b>	378260		
	<b>GEV No.</b>	<b>Ref. No.</b>	020519-00 020519-00R
	temperature probe NTC 10kOhm cable thermoplastic probe -40 up to +110°C cable -40 up to +110°C probe ø6x35mm cable length 3m without screw connection 2-wire		
	<b>GEV No.</b>	<b>Ref. No.</b>	02128300 021283-00R
	temperature probe NTC 2kOhm cable thermoplastic probe -40 up to +110°C cable -40 up to +110°C probe ø6x35mm cable length 2m without screw connection 2-wire resistor 2kOhm		

built-in version 2-piece



1

<b>GEV No.</b>	403413	<b>Ref. No.</b>	00-556225
<b>description</b>	power PCB LAE type LF28B253E-1FS mounting measurements 104x91mm 230V voltage AC NTC relay outputs 3 NO-20A(6) NO-12A(4) NO-7A(2) NTC NTC DI DI front measurements 105x63mm built-in depth 45mm protection IP2x -50 up to +80°C display		
<b>accessories for</b>	403413		
	<b>GEV No.</b>	<b>Ref. No.</b>	—
	keypad unit LAE type LCD5-5 mounting measurements 71x29mmV voltage relay outputs front measurements 77x35x20mm built-in depth 20mm protection IP55°C display 3 digits		
	<b>GEV No.</b>	<b>Ref. No.</b>	02128300 021283-00R
	temperature probe NTC 2kOhm cable thermoplastic probe -40 up to +110°C cable -40 up to +110°C probe ø6x35mm cable length 2m without screw connection 2-wire resistor 2kOhm		
	<b>GEV No.</b>	<b>Ref. No.</b>	—
	connection cable LAE type FC06-20M01		



## SHANGFANG

## accessories



1	<b>GEV No.</b>	379054	<b>Ref. No.</b>	014675-00 01467500R
<b>description</b> transformer primary 230VAC secondary 12VAC 3VA secondary 0.25A H 40mm L 45mm W 50mm connection screw 50/60Hz type 153/M				

## miscellaneous

## electronic thermometers



1	<b>GEV No.</b>	379022	<b>Ref. No.</b>	527601R
<b>description</b> thermometer mounting measurements 28.5x70.5mm -55 up to +99°C type EWTM 101				

## probes

## universal probes

## temperature probes

1	<b>GEV No.</b>	379784	<b>Ref. No.</b>	02128300 021283-00R
<b>description</b> temperature probe NTC 2kOhm cable thermoplastic probe -40 up to +110°C cable -40 up to +110°C probe ø6x35mm cable length 2m without screw connection 2-wire resistor 2kOhm				

1	<b>GEV No.</b>	378261	<b>Ref. No.</b>	020519-00 020519-00R
<b>description</b> temperature probe NTC 10kOhm cable thermoplastic probe -40 up to +110°C cable -40 up to +110°C probe ø6x35mm cable length 3m without screw connection 2-wire				

1	<b>GEV No.</b>	379805	<b>Ref. No.</b>	025461-00
<b>description</b> temperature probe NTC 10kOhm cable TPE probe -40 up to +110°C cable -40 up to +110°C probe ø6x28mm cable length 2m cable colours grey 2-wire				

1	<b>GEV No.</b>	379064	<b>Ref. No.</b>	014674-00 01467400R 014674-01 01467401R
<b>description</b> temperature probe PTC 1kOhm cable silicone probe -50 up to +150°C cable -50 up to +180°C probe ø6x40mm cable length 3m without screw connection 2-wire				

## Зип-Общепит

## core probes

1	<b>GEV No.</b>	379640	<b>Ref. No.</b>	N/A
<b>description</b> core temperature probe PTC 1kOhm cable silicone probe -50 up to +150°C cable -50 up to +180°C probe ø6x110mm cable length 2.4m handle ø9mm handle length 80mm 2-wire				

## producer-specific probes

## core probes

1	<b>GEV No.</b>	378408	<b>Ref. No.</b>	019064-00 019064-00R
<b>description</b> core temperature probe PTC cable silicone probe -40 up to +120°C cable -50 up to +180°C connection 2-wire probe ø4-6x105mm cable length 3.5m handle ø13mm handle length 120mm				

## electronics

## PCBs

1	<b>GEV No.</b>	401936	<b>Ref. No.</b>	24000001
<b>description</b> keypad PCB with control				



Зип Общежит

membrane keypads

vsezip.ru

+7(812)987-08-81



1

<b>GEV No.</b>	401900	<b>Ref. No.</b>	215029
<b>description</b>	PCB L 120mm W 80mm		
<b>For models:</b>	D500LS, D501LS		

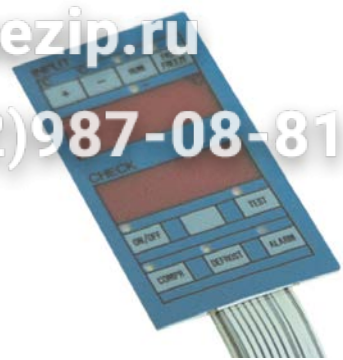

1

<b>GEV No.</b>	402023	<b>Ref. No.</b>	01086805R
<b>description</b>	membrane keypad		



1

<b>GEV No.</b>	402015	<b>Ref. No.</b>	016369-00R
<b>description</b>	PCB refrigerated counter Skin		

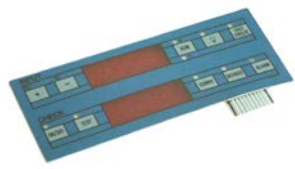

1

<b>GEV No.</b>	402024	<b>Ref. No.</b>	01087005R
<b>description</b>	membrane keypad		

## keypads

### front foils



1

<b>GEV No.</b>	402030	<b>Ref. No.</b>	01271301R
<b>description</b>	front foil		



1

<b>GEV No.</b>	402031	<b>Ref. No.</b>	01345001R
<b>description</b>	front foil		



1

<b>GEV No.</b>	402032	<b>Ref. No.</b>	01654900R
<b>description</b>	front foil		

## solenoïd valves

### solenoïd valves (water)

ELBI

straight



1

<b>GEV No.</b>	373017	<b>Ref. No.</b>	240016	
<b>description</b>	solenoïd valve single straight 230VAC inlet 3/4" outlet 11.5mm DN10 ELBI			
<b>For models:</b>	D500LS, D501LS			
<b>spare parts for</b>	373017			
	<b>GEV No.</b>	370467	<b>Ref. No.</b>	—
solenoïd valve filter suitable for ELBI				

ELTEK



1













<b>GEV No.</b>	370779	<b>Ref. No.</b>	2DR025
<b>description</b>	solenoïd valve single straight 230VAC inlet 3/4 outlet 11.5mm input 7l/min output 1.2l/min DN10 ELTEK		
<b>For models:</b>	KL030-10-000A		

Зип-Общепит

vsezip.ru

+7(812)987-08-81

RPE			
solenoid valves with reducers			
2-fold			
			
1			
<b>GEV No.</b>	370835	<b>Ref. No.</b>	2DR026
<b>description</b>	solenoid valve double straight 230VAC inlet 3/4" outlet 10.5mm input 7l/min output 2x1.2l/min DN10 t.max. 90°C RPE		
<b>For models:</b>	KL030-10-000W		

TP			
			
1			
<b>GEV No.</b>	370017	<b>Ref. No.</b>	240011
<b>description</b>	solenoid valve single straight 230VAC inlet 3/4" outlet 11.5mm DN10 TP p max 10bar		
<b>For models:</b>	D500LS, D501LS		
<b>spare parts for</b>	370017		
	<b>GEV No.</b>	371013	<b>Ref. No.</b> —
solenoid coil TP 230VAC 50/60Hz			
<b>accessories for</b>	370017		
	<b>GEV No.</b>	371220	<b>Ref. No.</b> —
reducer TP flow rate 3l/min red tolerance ±15%			
	<b>GEV No.</b>	371221	<b>Ref. No.</b> —
reducer TP flow rate 5.5l/min yellow tolerance ±15%			
	<b>GEV No.</b>	371222	<b>Ref. No.</b> —
reducer TP flow rate 6l/min grey tolerance ±15%			
	<b>GEV No.</b>	371223	<b>Ref. No.</b> —
reducer TP flow rate 10l/min white tolerance ±15%			
	<b>GEV No.</b>	371224	<b>Ref. No.</b> —
reducer TP flow rate 12l/min bronze tolerance ±15%			
	<b>GEV No.</b>	371225	<b>Ref. No.</b> —
reducer TP flow rate 16l/min light brown tolerance ±15%			
	<b>GEV No.</b>	371226	<b>Ref. No.</b> —
reducer TP flow rate 20l/min red tolerance ±15%			
	<b>GEV No.</b>	371230	<b>Ref. No.</b> —
reducer TP flow rate 0.25l/min red tolerance ±25%			
	<b>GEV No.</b>	371231	<b>Ref. No.</b> —
reducer TP flow rate 0.35l/min violet tolerance ±25%			
	<b>GEV No.</b>	371232	<b>Ref. No.</b> —
reducer TP flow rate 0.5l/min orange tolerance ±25%			

	<b>GEV No.</b>	371233	<b>Ref. No.</b>	—
reducer TP flow rate 0.8l/min white tolerance ±25%				
	<b>GEV No.</b>	371234	<b>Ref. No.</b>	—
reducer TP flow rate 1l/min light blue tolerance ±25%				
	<b>GEV No.</b>	371235	<b>Ref. No.</b>	—
reducer TP flow rate 1.2l/min brown tolerance ±25%				
	<b>GEV No.</b>	371236	<b>Ref. No.</b>	—
reducer TP flow rate 1.5l/min light brown tolerance ±25%				
	<b>GEV No.</b>	371237	<b>Ref. No.</b>	—
reducer TP flow rate 2.5l/min yellow tolerance ±25%				
	<b>GEV No.</b>	371238	<b>Ref. No.</b>	—
reducer TP flow rate 3.4l/min dark green tolerance ±25%				
	<b>GEV No.</b>	371239	<b>Ref. No.</b>	—
reducer TP flow rate 5l/min black tolerance ±25%				
	<b>GEV No.</b>	371240	<b>Ref. No.</b>	—
reducer TP flow rate 8l/min blue tolerance ±20%				









			
1			
<b>GEV No.</b>	370015	<b>Ref. No.</b>	015552-00 01555200R
<b>description</b>	solenoid valve single angled 230VAC inlet 3/4" outlet 11.5mm DN10 TP		
<b>accessories for</b>	370015		
	<b>GEV No.</b>	371220	<b>Ref. No.</b> —
reducer TP flow rate 3l/min red tolerance ±15%			
	<b>GEV No.</b>	371221	<b>Ref. No.</b> —
reducer TP flow rate 5.5l/min yellow tolerance ±15%			
	<b>GEV No.</b>	371222	<b>Ref. No.</b> —
reducer TP flow rate 6l/min grey tolerance ±15%			
	<b>GEV No.</b>	371223	<b>Ref. No.</b> —
reducer TP flow rate 10l/min white tolerance ±15%			
	<b>GEV No.</b>	371224	<b>Ref. No.</b> —
reducer TP flow rate 12l/min bronze tolerance ±15%			
	<b>GEV No.</b>	371225	<b>Ref. No.</b> —
reducer TP flow rate 16l/min light brown tolerance ±15%			
	<b>GEV No.</b>	371226	<b>Ref. No.</b> —
reducer TP flow rate 20l/min red tolerance ±15%			

Table continues overleaf













Зип Общедит  
solenoid valves (refrigeration)

vsezip.ru  
valve bodies

+7(812)987-08-81

accessories for		370015	
GEV No.	371230	Ref. No.	—
	reducer TP flow rate 0.25l/min red tolerance ±25%		
	reducer TP flow rate 0.35l/min violet tolerance ±25%		
	reducer TP flow rate 0.5l/min orange tolerance ±25%		
	reducer TP flow rate 0.8l/min white tolerance ±25%		
	reducer TP flow rate 1l/min light blue tolerance ±25%		
	reducer TP flow rate 1.2l/min brown tolerance ±25%		
	reducer TP flow rate 1.5l/min light brown tolerance ±25%		
	reducer TP flow rate 2.5l/min yellow tolerance ±25%		
	reducer TP flow rate 3.4l/min dark green tolerance ±25%		
	reducer TP flow rate 5l/min black tolerance ±25%		
	reducer TP flow rate 8l/min blue tolerance ±20%		

**DANFOSS**  
valve bodies



1

GEV No.	370160	Ref. No.	012719-00 01271900R
<b>description</b>	solenoid valve body NC type EVR 3 p max 45.2bar DN 3.2mm connection 6mm soldering connection -40° up to 105°C refrigeration straight DANFOSS		
<b>accessories for</b>	370160		
	GEV No.	371046	Ref. No. —
	console for solenoid valve for EVR2,3,6,10		

various



1

GEV No.	370726	Ref. No.	999288
<b>description</b>	solenoid valve double straight 220-240VAC inlet 11mm outlet 11mm MILANO plastic output B red		
<b>For models:</b>	D500LS, D501LS		

**PARKER**  
valves



1

GEV No.	370782	Ref. No.	1RF123
<b>description</b>	solenoid valve 230V connection 16mm soldering connection PARKER refrigeration straight		
<b>For models:</b>	KL030-10-000A, KL030-10-000W		
<b>spare parts for</b>	370782		
	GEV No.	371033	Ref. No. —
	solenoid coil PARKER 230VAC 9VA coil type YB09 with cable seat ø 14mm		

**pressure switches**  
for warewashing

ø 58mm with male faston 6.3mm  
with connection horizontal



1

GEV No.	541011	Ref. No.	224010
<b>description</b>	pressure control pressure range 110/70mbar connection 6mm ø 58mm pressure connection horizontal warewashing		
<b>For models:</b>	D500LS, D501LS		

electric components



ЗипОбщепит

R134A  
HMBP monophase

High/Medium evaporation temperature above -20/-15 °C



1

<b>GEV No.</b>	541003	<b>Ref. No.</b>	224003
<b>description</b>	pressure control pressure range 55/35mbar connection 6mm ø 58mm pressure connection horizontal warewashing pressure connection ø 6mm		
<b>For models:</b>	D500LS, D501LS		

accessories



1

<b>GEV No.</b>	541109	<b>Ref. No.</b>	035031
<b>description</b>	Y-piece plastic hose ø 8-6-8mm for pressure switch		
<b>For models:</b>	D500LS, D501LS		

### compressors

#### ACC/ZEL

R134A  
HMBP monophase

High/Medium evaporation temperature above -20/-15 °C



1

<b>GEV No.</b>	605009	<b>Ref. No.</b>	022260-00
<b>description</b>	compressor coolant R134a type GL90TB 220-240V 50Hz HMBP fully hermetic 10.8kg 1/4HP power input 293W cylinder capacity 8.8cm <sup>3</sup> CSIR H 175.5mmW 143W 194W 259W 339W 432W 539W 661W 796W test method ASHRAE		



1

<b>GEV No.</b>	605091	<b>Ref. No.</b>	014614-00	
<b>description</b>	compressor coolant R134a type FR8.5G 220-240V 50Hz HMBP 10.6kg 1/4HP power input 261W cylinder capacity 7.95cm <sup>3</sup> RSIR/CSIR H 196mm 85W 123W 171W 228W 298W 381W 478W 592W 722WW			
<b>spare parts for</b>	605091			
	<b>GEV No.</b>	380484	<b>Ref. No.</b>	—
	start relay DANFOSS 117U6015/F394 HST			

R404a/R507  
LBP monophase

Lower evaporation temperature below -20°C



1

<b>GEV No.</b>	605057	<b>Ref. No.</b>	015132-00	
<b>description</b>	compressor coolant R404a/R507 type SC12CL 220-240V 50Hz LBP fully hermetic 12.5kg 3/8HP cylinder capacity 12.87cm <sup>3</sup> CSIR H 209mm 410W 568W 754W 971W 1220W 1505WWWW test method ASHRAE			
<b>spare parts for</b>	605057			
	<b>GEV No.</b>	380078	<b>Ref. No.</b>	—
	start relay DANFOSS 117U6005 HST			



fans

axial fans

ebm-papst

Зип Общепит

vsezip.ru

+7(812)987-08-81



1

<b>GEV No.</b>	601089 <sup>1</sup>	<b>Ref. No.</b>	01348001R
<b>description</b>	axial fan L 119mm W 119mm H 38mm 230VAC 50/60Hz 19W bearing slide bearing manuf. no. 4650N metal connection male faston 2.8mm ebm-papst fan wheel ø 110mm temp.-resist. 55°C		
<b>accessories for</b>	601089		
	<b>GEV No.</b>	550898	<b>Ref. No.</b> —
	connecting cable cable length 2000mm connection F 2.8 connection distance 7.9mm for axial flow fan		
	<b>GEV No.</b>	691104	<b>Ref. No.</b> —
	guard ø 115mm mounting distance 105mm for axial fan 119mm		

<sup>1</sup>with slide bearings

ebmpapst



1

<b>GEV No.</b>	601082 <sup>1</sup>	<b>Ref. No.</b>	01468000R 01979700R
<b>description</b>	axial fan L 92mm W 92mm H 25mm 230VAC 50/60Hz 9/11W bearing ball bearing manuf. no. 3956 metal connection male faston 2.8mm ebm-papst fan wheel ø 85mm temp.-resist. 80°C		
<b>accessories for</b>	601082		
	<b>GEV No.</b>	691103	<b>Ref. No.</b> —
	guard ø 90mm mounting distance 83mm for axial fan 92mm		

<sup>1</sup>with ball bearings



1

<b>GEV No.</b>	601074 <sup>1</sup>	<b>Ref. No.</b>	01904100R
<b>description</b>	axial fan L 92mm W 92mm H 25mm 24VDC 2.3W bearing ball bearing manuf. no. 3414N connection cable 300mm ebm-papst fan wheel ø 85mm temp.-resist. 70°C		
<b>accessories for</b>	601074		
	<b>GEV No.</b>	691103	<b>Ref. No.</b> —
	guard ø 90mm mounting distance 83mm for axial fan 92mm		

<sup>1</sup>with ball bearings



1

<b>GEV No.</b>	601632 <sup>1</sup>	<b>Ref. No.</b>	01904100
<b>description</b>	axial fan L 92mm W 92mm H 25mm 24VDC 2.3W bearing slide bearing manuf. no. 3414NG connection cable 310mm ebm-papst		
<b>accessories for</b>	601632		
	<b>GEV No.</b>	691103	<b>Ref. No.</b> —
	guard ø 90mm mounting distance 83mm for axial fan 92mm		

<sup>1</sup>with slide bearings



1

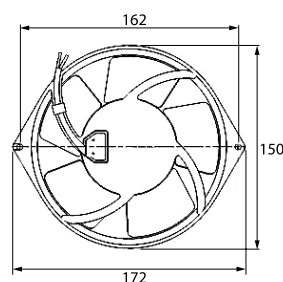

<b>GEV No.</b>	601088 <sup>1</sup>	<b>Ref. No.</b>	01468500R
<b>description</b>	axial fan L 172mm W 150mm H 55mm 230VAC 50/60Hz 39/45W bearing ball bearing connection cable 350mm manuf. no. 7855ES metal ebm-papst fan wheel ø 140mm temp.-resist. 50°C		

<sup>1</sup>with ball bearings

→ electric components



# Зип-Общепит

vsezip.ru

+7(812)987-08-81

import



<b>GEV No.</b>	601055 <sup>1</sup>	<b>Ref. No.</b>	01468000
<b>description</b>	axial fan L 92mm W 92mm H 25mm 230VAC 50/60Hz 14.5/14W bearing ball bearing connection male faston 2.8mm metal ADDA fan wheel ø 85mm temp.-resist. 70°C		
<b>accessories for</b>	601055		
	<b>GEV No.</b>	550898	<b>Ref. No.</b> —
	connecting cable cable length 2000mm connection F 2.8 connection distance 7.9mm for axial flow fan		
	<b>GEV No.</b>	691103	<b>Ref. No.</b> —
	guard ø 90mm mounting distance 83mm for axial fan 92mm		

<sup>1</sup>with ball bearings

## refrigeration fans

### refrigeration motors universal

IMPORT

multi fit fan motors



<b>GEV No.</b>	601022	<b>Ref. No.</b>	01272500R
<b>description</b>	fan motor 10W 230V 50-60Hz L1 44mm L2 54mm L3 85mm W 84mm cable length 500mm 1300rpm YZF10-20-18/26 5 mounting options bearing slide bearing		

accessories

fan wheels

<b>GEV No.</b>	601071	<b>Ref. No.</b>	013479-00
<b>description</b>	fan wheel sucking ø 230mm fan wheel mounting 25.4mm blade angle 25° W 37mm aluminium		

## cold air circulating fans (complete)

ebm-papst

A2E series

<b>GEV No.</b>	601962	<b>Ref. No.</b>	019055-00
<b>description</b>	fan A2E250AM06-01 fan wheel ø 250mm blades 9 230V 50Hz 120/160W 2450rpm cable length 400mm ebm-papst blowing suitable capacitor 3µF		
<b>spare parts for</b>	601962		
	<b>GEV No.</b>	365137	<b>Ref. No.</b> —
	capacitor capacity 3µF 450V tolerance 5% 50/60Hz ambient temperature max. -25 to +85°C ø 25mm L 56mm M8 plastic connection cable 250mm 416.17.77GF protection		





Зип Общежит

cross flow fans

COPREL  
with moulded coils

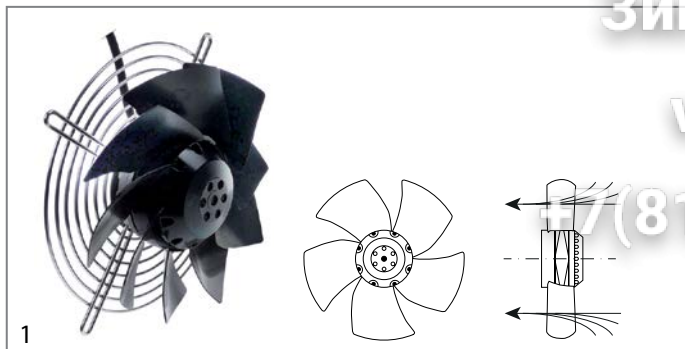
+7(812)987-08-81



<b>GEV No.</b>	601663 <sup>1</sup>	<b>Ref. No.</b>	019027-00
<b>description</b>	fan A2E200-AI38-10 fan wheel ø 200mm blades 9 230V 50/60Hz 64W 2600rpm cable length 450mm ebm-papst sucking suitable capacitor 1.5µF with protective grid		
<b>spare parts for</b>	601663		
	<b>GEV No.</b>	365171	<b>Ref. No.</b> 019051-00
	capacitor capacity 1.5µF 400V tolerance 5% 50/60Hz ambient temperature max. -40 up to +85°C ø 25mm L 50mm M8 plastic connection cable 250mm MLR25PRL		
	<b>GEV No.</b>	601958	<b>Ref. No.</b> —
	guard ø 210mm for fan hole distance 258mm		

<sup>1</sup>incl. capacitor and guard

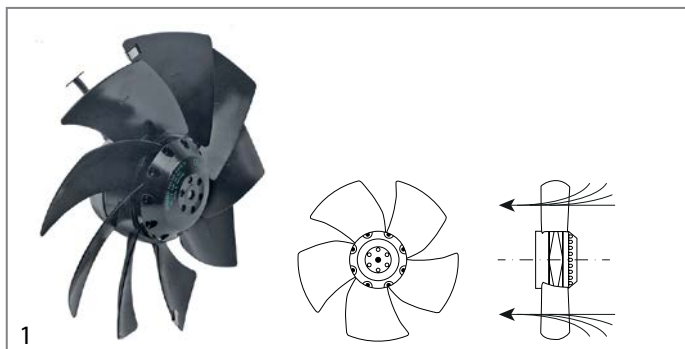

<b>GEV No.</b>	601964	<b>Ref. No.</b>	GF650/2 GF651
<b>description</b>	fan A2E250AM06-12 fan wheel ø 250mm blades 9 230V 50/60Hz 115/150W ø 250mm 2450rpm cable length 1400mm sucking suitable capacitor 3µF		
<b>spare parts for</b>	601964		
	<b>GEV No.</b>	365137	<b>Ref. No.</b> —
	capacitor capacity 3µF 450V tolerance 5% 50/60Hz ambient temperature max. -25 to +85°C ø 25mm L 56mm M8 plastic connection cable 250mm 416.17.77GF protection		

**1**



<b>GEV No.</b>	601456	<b>Ref. No.</b>	01272600R
<b>description</b>	cross flow fan roller ø 45mm roller length 180mm laminated core thickness 15mm motor position right 230V/50Hz 26W universal bearing silicone connection male faston 6.3mm -30 up to +100°C 230V 50/60Hz		

hot air fans  
miscellaneous

**1**

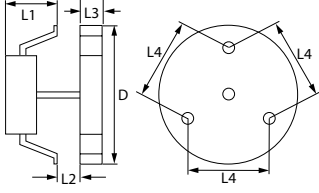
<b>GEV No.</b>	601094	<b>Ref. No.</b>	01154900R+01155000R
<b>description</b>	fan motor 240V 36W 50Hz L1 85mm L2 15mm L3 20mm L4 87mm fan wheel ø 150mm Emmevi type 260305X		

electric components

Зип,Общепит pumps

wash and rinse pumps vsezip.ru

+7(812)987-08-81

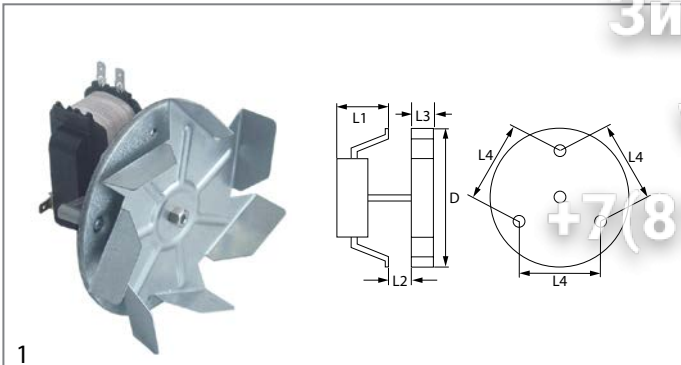

<b>GEV No.</b>	601124	<b>Ref. No.</b>	9343420000 RIC0002339
<b>description</b>	hot air fan 220-240V 30W L1 60mm L2 12mm L3 25mm L4 84mm fan wheel ø 150mm IMS type VRB150H2028		
<b>For models:</b>	ME066-03-010, ME066-03-013, ME103-03-013XL, ME106-03-010XL, ME106-03-013		



<b>GEV No.</b>	601531	<b>Ref. No.</b>	3740035
<b>description</b>	hot air fan 220V 30W 50Hz L1 70mm L2 12mm L3 30mm L4 87mm fan wheel ø 155mm FIME type C30R0407		



<b>GEV No.</b>	500156	<b>Ref. No.</b>	130109
<b>description</b>	pump inlet ø 50mm outlet ø 50mm type ZF400SX 230V 50Hz 1 phase 0.6kW 0.8HP L 210mm rotation direction right capacitor 16µF LGB		
<b>For models:</b>	D500LS, D501LS		
<b>spare parts for</b>	500156		

<b>GEV No.</b>	509020	<b>Ref. No.</b>	124031
<b>description</b>	impellor ø 104mm H 25mm M8L		
<b>GEV No.</b>	510703	<b>Ref. No.</b>	141007
<b>description</b>	mechanical shaft seal for shaft ø 13mm slide ring H 13mm height counter ring 5.5mm ED ø 26mm		
<b>GEV No.</b>	521548	<b>Ref. No.</b>	116019
<b>description</b>	pump cover LGB inlet ø 50mm outlet ø 50mm		
<b>GEV No.</b>	521734	<b>Ref. No.</b>	315022
<b>description</b>	pump cover bottom part		
<b>GEV No.</b>	523509	<b>Ref. No.</b>	314001
<b>description</b>	deep-groove ball bearing type 6201-2RS shaft ø 12mm ED ø 32mm W 10mm with sealing discs deep-groove ball bearing DIN 625-1		
<b>GEV No.</b>	532623	<b>Ref. No.</b>	—
<b>description</b>	O-ring EPDM thickness 2.62mm ID ø 120.32mm Qty 1 pcs		
<b>accessories for</b>	500156		
<b>GEV No.</b>	365021	<b>Ref. No.</b>	206004
<b>description</b>	operating capacitor capacity 16µF 425V tolerance 5% 50/60Hz ambient temperature max. -25 to +85°C ø 35mm L 73mm single M8 plastic connection male faston 6.3mm 416.10.99 protection		

motors

motors

for tilting bratt pans



<b>GEV No.</b>	500813	<b>Ref. No.</b>	RTBF900122
<b>description</b>	motor 120W 230V 50Hz 1 phase shaft ø 9mm shaft length 20mm 2750rpm type M TUBO 56 ø 100mm H 155mm capacitor 6.3µF AMI 0.12kW		
<b>For models:</b>	MG099-03-012, MG099-13-012I		



drain pumps

ASKOLL



1

<b>GEV No.</b>	500214	<b>Ref. No.</b>	130105
<b>description</b>	drain pump inlet ø 30mm outlet ø 22mm 230/240V 30W 50Hz ASKOLL type R113		
<b>For models:</b>	D500LS, D501LS		

pumps for ice machines



1

<b>GEV No.</b>	499341	<b>Ref. No.</b>	2DR100
<b>description</b>	pump MIGEL 100W 230V 50Hz inlet ø 23mm outlet ø 25mm L 170mm rotation direction right ice maker		
<b>For models:</b>	KL030-10-000A, KL030-10-000W		



1

<b>GEV No.</b>	499003	<b>Ref. No.</b>	1DR037 2DR093
<b>description</b>	pump MIGEL type 100W 230V 50Hz inlet ø 25mm outlet ø 23mm L 170mm rotation direction right for ice maker		

condensators & interference suppression filters

starting capacitors

starting capacitors



1

<b>GEV No.</b>	365061	<b>Ref. No.</b>	020551-00
<b>description</b>	starting capacitor 220/300V 50Hz DANFOSS duty cycle 1.7/0.10% capacity 80µF for FR/NL		

operating capacitors

plastic



1

<b>GEV No.</b>	365171	<b>Ref. No.</b>	019051-00
<b>description</b>	capacitor capacity 1.5µF 400V tolerance 5% 50/60Hz ambient temperature max. -40 up to +85°C ø 25mm L 50mm M8 plastic connection cable 250mm MLR25PRL		



1

<b>GEV No.</b>	365021	<b>Ref. No.</b>	206004
<b>description</b>	operating capacitor capacity 16µF 425V tolerance 5% 50/60Hz ambient temperature max. -25 to +85°C ø 35mm L 73mm single M8 plastic connection male faston 6.3mm 416.10.99 protection		
<b>For models:</b>	D500LS, D501LS		

fuses

fine fuses



1

<b>GEV No.</b>	358677	<b>Ref. No.</b>	228010
<b>description</b>	fine fuse size ø5x20mm 4A fast-acting rated 250V Qty 10 pcs		
<b>For models:</b>	D500LS, D501LS		

fine fuse holders



<b>GEV No.</b>	551234	<b>Ref. No.</b>	210010
<b>description</b>	fuse holder suitable fuse $\varnothing 5 \times 20 \text{mm}$ 1-pole 6.3A rated 600V L 52mm W 8mm H 51mm connection screw clamp cross section $4 \text{mm}^2$		
<b>For models:</b>	D500LS, D501LS		

electric accessories

terminals

terminal blocks



<b>GEV No.</b>	550239	<b>Ref. No.</b>	RTBF900045
<b>description</b>	lustre terminal 12-pole cross section $16 \text{mm}^2$ max. 75A max 500V temp.-resist. $150^\circ\text{C}$		
<b>For models:</b>	ME046-03-000, ME046-03-000V, ME046-03-001, ME046-03-002, ME046-03-003, ME046-03-004, ME046-03-005, ME046-13-001, ME046-13-002, ME066-03-000, ME066-03-000V, ME066-03-003, ME066-03-004, ME066-03-006, ME066-03-007, ME066-03-008, ME066-03-010, ME066-03-013, ME066-03-015, ME066-13-003, ME103-03-013XL, ME106-03-000, ME106-03-010XL, ME106-03-013, ME106-13-003, MG066-03-010, MG099-03-012, MG099-03-012M, MG099-13-012L, MG099-13-012IM, MG106-03-010, MG106-03-010XL		

connection terminals with screw/faston connections



<b>GEV No.</b>	550411	<b>Ref. No.</b>	220011
<b>description</b>	power terminal block 6-pole max. 40A max 450V connection $\varnothing 6 \text{mm}^2$ / F6.3 temp.-resist. $150^\circ\text{C}$ cross section $6 \text{mm}^2$		
<b>For models:</b>	D500LS, D501LS		

rail-mounted terminals

miscellaneous



<b>GEV No.</b>	551234	<b>Ref. No.</b>	210010
<b>description</b>	fuse holder suitable fuse $\varnothing 5 \times 20 \text{mm}$ 1-pole 6.3A rated 600V L 52mm W 8mm H 51mm connection screw clamp cross section $4 \text{mm}^2$		
<b>For models:</b>	D500LS, D501LS		

gas taps

PEL

vsezip.ru

215 series



<b>GEV No.</b>	101397	<b>Ref. No.</b>	RTCU700259	
<b>description</b>	gas tap PEL type 215 gas inlet M16x1.5 (tube $\varnothing 10 \text{mm}$ ) bypass nozzle $\varnothing 0.35 \text{mm}$ gas outlet M16x1.5 (tube $\varnothing 10/8 \text{mm}$ ) thermocouple connection M9x1 pilot connection M10x1 shaft $\varnothing 8 \times 6.5 \text{mm}$ shaft L 22/15mm shaft flat lower			
<b>For models:</b>	MG066-03-008, MG086-13-014P			
<b>spare parts for</b>	101397			
	<b>GEV No.</b>	100408	<b>Ref. No.</b>	—
	bypass nozzle type PEL20/21 bore $\varnothing 0.35 \text{mm}$ thread M5x0.5			
	<b>GEV No.</b>	101060	<b>Ref. No.</b>	—
	magnet unit standard L 39mm D1 $\varnothing 15.4 \text{mm}$ D2 $\varnothing 11 \text{mm}$ suitable for PEL20-21/JUNKERS/EGA			
	<b>GEV No.</b>	101206	<b>Ref. No.</b>	—
	gas tap front part shaft $\varnothing 8 \times 6.5 \text{mm}$ shaft L 22/15mm shaft flat upper/lower suitable for PEL21			
	<b>GEV No.</b>	101231	<b>Ref. No.</b>	—
	thermocouple nut T1: M9x1 T2: M18x1			
<b>accessories for</b>	101397			
	<b>GEV No.</b>	100908	<b>Ref. No.</b>	RTCU900133
	union screw thread M10x1 for pipe $\varnothing 4 \text{mm}$ Qty 1 pcs			
	<b>GEV No.</b>	100909	<b>Ref. No.</b>	RTCP800038 RTCU900019
	union screw thread M10x1 for pipe $\varnothing 6 \text{mm}$ Qty 1 pcs			
	<b>GEV No.</b>	101246	<b>Ref. No.</b>	—
	olive for pipe $\varnothing 4 \text{mm}$ Qty 1 pcs			
	<b>GEV No.</b>	101278	<b>Ref. No.</b>	RTCU900012
	olive for pipe $\varnothing 10 \text{mm}$ Qty 1 pcs			
	<b>GEV No.</b>	101286	<b>Ref. No.</b>	RTCU900018
	olive ID $\varnothing 6 \text{mm}$ Qty 1 pcs			
	<b>GEV No.</b>	101300	<b>Ref. No.</b>	RTCU700297
	union nut thread M16x1.5 tube $\varnothing 10 \text{mm}$			
	<b>GEV No.</b>	101450	<b>Ref. No.</b>	—
	olive for pipe $\varnothing 8 \text{mm}$ L 12.7mm Qty 1 pcs ED $\varnothing 10 \text{mm}$			
	<b>GEV No.</b>	101451	<b>Ref. No.</b>	—
	union nut thread M16x1.5 tube $\varnothing 8 \text{mm}$			
	<b>GEV No.</b>	110081	<b>Ref. No.</b>	—
	knob $\varnothing 70 \text{mm}$ shaft $\varnothing 8 \times 6.5 \text{mm}$ shaft flat universal			
	<b>GEV No.</b>	112206	<b>Ref. No.</b>	—
	knob dial plate silver gas tap PEL21/22/23 t.max. $^\circ\text{C}$ ED $\varnothing 63 \text{mm}$ ID $\varnothing 45.5 \text{mm}$			











SABAF

Зип Общепит

vsezip.ru



+7(812)987-08-81

			
1			
<b>GEV No.</b>	101890	<b>Ref. No.</b>	RTCU600016
<b>description</b>	gas tap SABAF type 10 gas inlet pipe flange ø16mm bypass nozzle ø 0mm gas outlet 1/4" (tube ø 8mm) front fixing thermocouple connection plug-in connection shaft ø 8x6.5mm shaft L 26/12mm shaft flat upper		
<b>For models:</b>	ME066-03-010, ME106-03-010XL, MG046-03-000, MG066-03-000, MG066-03-010, MG106-03-000, MG106-03-010, MG106-03-010XL		
<b>spare parts for</b>	101890		
	<b>GEV No.</b>	101376	<b>Ref. No.</b> —
	gasket ID ø 8mm ED ø 12mm H 3/5mm		
	<b>GEV No.</b>	106723	<b>Ref. No.</b> —
	magnet unit L 29mm D1 ø 12.5mm D2 ø 8.5mm suitable for SABAF		
<b>accessories for</b>	101890		
	<b>GEV No.</b>	101277	<b>Ref. No.</b> —
	olive ID ø 8mm Qty 1 pcs		
	<b>GEV No.</b>	101751	<b>Ref. No.</b> RTCU600054
	bracket		
	<b>GEV No.</b>	520656	<b>Ref. No.</b> —
	union nut thread 1/4" tube ø 6/8mm		
	<b>GEV No.</b>	560082	<b>Ref. No.</b> —
	hexagonal screw thread M4 thread L 16mm SS WS 7 Qty 20 pcs DIN 933 / ISO 4017		

gas thermostats

SIT

710 Minisit series

			
1			
<b>GEV No.</b>	101135	<b>Ref. No.</b>	RTCU700574
<b>description</b>	gas thermostat SIT type MINISIT 710 t.max. 190°C 110-190°C gas inlet 1/2" gas outlet 3/8" thermocouple connection M9x1 pilot connection M10x1 probe ø 6mm probe L 102mm capillary pipe 1050mm probe type type A3 pressure controller no pressure regulator bar gland nut		
<b>For models:</b>	MG046-03-004, MG066-03-007		
<b>spare parts for</b>	101135		
	<b>GEV No.</b>	101053	<b>Ref. No.</b> —
	magnet unit T1: M9x1 T2: M24x1 L 45mm ø 17mm suitable for Minisit		













<b>spare parts for</b>	101135		
<b>GEV No.</b>	102118	<b>Ref. No.</b>	—
	probe 110-190°C probe ø 6mm probe L 102mm capillary pipe 1050mm t. max. 190°C fryer probe type type A3 suitable for MINISIT 710		
<b>accessories for</b>	101135		
	<b>GEV No.</b>	100800	<b>Ref. No.</b> —
	O-ring EPDM thickness 2mm ID ø 21mm Qty 1 pcs		
	<b>GEV No.</b>	100820	<b>Ref. No.</b> —
	gland duct ET M14x1.5 IT M10x0.75 probe ø max. 6.5mm WS 22		
	<b>GEV No.</b>	100904	<b>Ref. No.</b> —
	locking screw M10x1 for pipe ø 4mm Qty 1 pcs		
	<b>GEV No.</b>	100905	<b>Ref. No.</b> —
	locking screw M10x1 for pipe ø 6mm Qty 1 pcs		
	<b>GEV No.</b>	101054	<b>Ref. No.</b> —
	magnet unit T1: M10x1 T2: M24x1 L 45mm ø 17mm suitable for Minisit		
	<b>GEV No.</b>	101136	<b>Ref. No.</b> —
	piezoelectric igniter suitable for Minisit with cover cap ømm connection F6.3x0.8		
	<b>GEV No.</b>	101137	<b>Ref. No.</b> —
	cover cap without piezoelectric igniter		
	<b>GEV No.</b>	101267	<b>Ref. No.</b> —
	reducer IT 3/8" ET 1/2" L 21mm		
	<b>GEV No.</b>	101268	<b>Ref. No.</b> —
	gas connection thread 3/8" angled with O-ring MINISIT 710		
	<b>GEV No.</b>	101269	<b>Ref. No.</b> —
	gas connection thread 1/2" angled with O-ring MINISIT 710		
	<b>GEV No.</b>	101270	<b>Ref. No.</b> —
	screw connection IT 3/8" ET 3/8" L 28mm		
	<b>GEV No.</b>	101272	<b>Ref. No.</b> —
	screw connection IT 1/2" ET 3/8" L 57mm		
	<b>GEV No.</b>	101273	<b>Ref. No.</b> —
	olive for pipe ø 12mm L 9.5mm brass Qty 1 pcs suitable for universal		
	<b>GEV No.</b>	101274	<b>Ref. No.</b> —
	olive for pipe ø 16mm Qty 1 pcs		
	<b>GEV No.</b>	101275	<b>Ref. No.</b> —
	union screw thread 1/2" for pipe ø 16mm Qty 1 pcs		
	<b>GEV No.</b>	101276	<b>Ref. No.</b> —
	union screw thread 3/8" tube ø 12mm Qty 1 pcs		
	<b>GEV No.</b>	110068	<b>Ref. No.</b> RTCU900222
	knob suitable for Minisit ø 37mm		

1 gas components

PEL

25ST series













<b>GEV No.</b>	101172	<b>Ref. No.</b>	RTCU700289
<b>description</b>	gas thermostat PEL type 25ST 100-300°C gas inlet M16x1.5 (tube ø 10mm) bypass nozzle ø 0.35mm gas outlet M16x1.5 (tube ø 10/8mm) thermocouple connection M9x1 pilot connection M10x1 capillary pipe 1200mm probe ø 6mm probe L 100mm shaft ø 8x6.5mm shaft L 21/15mm shaft flat upper		
<b>For models:</b>	MG046-03-001, MG046-03-002, MG046-13-001, MG046-13-002, MG066-03-003, MG066-03-004, MG066-03-005, MG066-03-015, MG066-13-003, MG066-13-004, MG066-13-005, MG106-03-003, MG106-03-004, MG106-13-003, MG106-13-004		
<b>spare parts for</b>	101172		
	<b>GEV No.</b>	100259	<b>Ref. No.</b> —
	bypass nozzle type PEL22 bore ø 0.35mm thread M6x0.5		
	<b>GEV No.</b>	101060	<b>Ref. No.</b> —
	magnet unit standard L 39mm D1 ø 15.4mm D2 ø 11mm suitable for PEL20-21/JUNKERS/EGA		
	<b>GEV No.</b>	106200	<b>Ref. No.</b> —
	nut thread M9x1 suitable for PEL 24/25S		
<b>accessories for</b>	101172		
	<b>GEV No.</b>	100908	<b>Ref. No.</b> RTCU900133
	union screw thread M10x1 for pipe ø 4mm Qty 1 pcs		
	<b>GEV No.</b>	100909	<b>Ref. No.</b> RTCP800038 RTCU900019
	union screw thread M10x1 for pipe ø 6mm Qty 1 pcs		
	<b>GEV No.</b>	101246	<b>Ref. No.</b> —
	olive for pipe ø 4mm Qty 1 pcs		
	<b>GEV No.</b>	101278	<b>Ref. No.</b> RTCU900012
	olive for pipe ø 10mm Qty 1 pcs		
	<b>GEV No.</b>	101286	<b>Ref. No.</b> RTCU900018
	olive ID ø 6mm Qty 1 pcs		
	<b>GEV No.</b>	101300	<b>Ref. No.</b> RTCU700297
	union nut thread M16x1.5 tube ø 10mm		
	<b>GEV No.</b>	101450	<b>Ref. No.</b> —
	olive for pipe ø 8mm L 12.7mm Qty 1 pcs ED ø 10mm		
	<b>GEV No.</b>	101451	<b>Ref. No.</b> —
	union nut thread M16x1.5 tube ø 8mm		
	<b>GEV No.</b>	110079	<b>Ref. No.</b> —
	knob dial plate gas thermostat 1-8 silver		
	<b>GEV No.</b>	110081	<b>Ref. No.</b> —
	knob ø 70mm shaft ø 8x6.5mm shaft flat universal		

Зип Общепит

vsezip.ru

+7(812)9877777



<b>GEV No.</b>	101441	<b>Ref. No.</b>	RTCU700363
<b>description</b>	gas thermostat PEL type 25ST 30-90°C gas inlet M16x1.5 (tube ø 10mm) bypass nozzle ø 0.35mm gas outlet M16x1.5 (tube ø 10/8mm) thermocouple connection M9x1 pilot connection M10x1 capillary pipe 1200mm probe ø 6mm probe L 160mm shaft ø 8x6.5mm shaft L 21/15mm shaft flat upper		
<b>For models:</b>	MG046-03-003, MG066-03-006		
<b>spare parts for</b>	101441		
	<b>GEV No.</b>	100259	<b>Ref. No.</b> —
	bypass nozzle type PEL22 bore ø 0.35mm thread M6x0.5		
	<b>GEV No.</b>	101060	<b>Ref. No.</b> —
	magnet unit standard L 39mm D1 ø 15.4mm D2 ø 11mm suitable for PEL20-21/JUNKERS/EGA		
	<b>GEV No.</b>	106200	<b>Ref. No.</b> —
	nut thread M9x1 suitable for PEL 24/25S		
<b>accessories for</b>	101441		
	<b>GEV No.</b>	100908	<b>Ref. No.</b> RTCU900133
	union screw thread M10x1 for pipe ø 4mm Qty 1 pcs		
	<b>GEV No.</b>	100909	<b>Ref. No.</b> RTCP800038 RTCU900019
	union screw thread M10x1 for pipe ø 6mm Qty 1 pcs		
	<b>GEV No.</b>	101246	<b>Ref. No.</b> —
	olive for pipe ø 4mm Qty 1 pcs		
	<b>GEV No.</b>	101278	<b>Ref. No.</b> RTCU900012
	olive for pipe ø 10mm Qty 1 pcs		
	<b>GEV No.</b>	101286	<b>Ref. No.</b> RTCU900018
	olive ID ø 6mm Qty 1 pcs		
	<b>GEV No.</b>	101300	<b>Ref. No.</b> RTCU700297
	union nut thread M16x1.5 tube ø 10mm		
	<b>GEV No.</b>	101450	<b>Ref. No.</b> —
	olive for pipe ø 8mm L 12.7mm Qty 1 pcs ED ø 10mm		
	<b>GEV No.</b>	101451	<b>Ref. No.</b> —
	union nut thread M16x1.5 tube ø 8mm		



SABAF



<b>GEV No.</b>	101886	<b>Ref. No.</b>	RTCU600179 RTCU600180
<b>description</b>	gas thermostat SABAF t.max. 300°C gas inlet pipe flange ø16mm bypass nozzle ø 0.37mm gas outlet M13x1 IT (tube ø 8mm) gas outlet 2 thermocouple connection M8x1 pilot connection capillary pipe 850mm probe ø 4mm probe L 140mm shaft ø 8x6.5mm shaft L 17/12mm shaft flat upper		
<b>For models:</b>	MG066-03-010, MG106-03-010, MG106-03-010XL		
<b>spare parts for</b>	101886		
	<b>GEV No.</b>	101060	<b>Ref. No.</b> —
	magnet unit standard L 39mm D1 ø 15.4mm D2 ø 11mm suitable for PEL20-21/JUNKERS/EGA		
<b>accessories for</b>	101886		
	<b>GEV No.</b>	101277	<b>Ref. No.</b> —
	olive ID ø 8mm Qty 1 pcs		
	<b>GEV No.</b>	101477	<b>Ref. No.</b> —
	union screw thread M13x1 tube ø 8mm Qty 1 pcs		
	<b>GEV No.</b>	101751	<b>Ref. No.</b> RTCU600054
	bracket		



gas valves and ignition boxes

gas control valves

SIT

ELETTROSIT



<b>GEV No.</b>	101126	<b>Ref. No.</b>	RTBF800077
<b>description</b>	gas valve SIT type ELETTROSIT 230V gas inlet 1/2" gas outlet 1/2" thermocouple connection M9x1 pilot connection M10x1 bottom equiv. no. 0.810.136		
<b>For models:</b>	MG099-03-012, MG099-03-012M, MG099-13-012I, MG099-13-012IM		
<b>spare parts for</b>	101126		
	<b>GEV No.</b>	101312	<b>Ref. No.</b> —
	microswitch		
	<b>GEV No.</b>	101352	<b>Ref. No.</b> —
	solenoid coil 230V 50Hz suitable for ELETTROSIT		

accessories for 101126

	<b>GEV No.</b>	100006	<b>Ref. No.</b> —
	piezoelectric igniter suitable for ELETTROSIT body plastic blowing connection ø2.4mm ø 14mm		
	<b>GEV No.</b>	100904	<b>Ref. No.</b> —
	locking screw M10x1 for pipe ø 4mm Qty 1 pcs		
	<b>GEV No.</b>	100905	<b>Ref. No.</b> —
	locking screw M10x1 for pipe ø 6mm Qty 1 pcs		
	<b>GEV No.</b>	101301	<b>Ref. No.</b> —
	gas connection thread 1/2" straight ELETTROSIT screw with O-ring		
	<b>GEV No.</b>	101303	<b>Ref. No.</b> —
	gas connection straight thread 3/4" ELETTROSIT		
	<b>GEV No.</b>	101309	<b>Ref. No.</b> —
	extension		

ignition parts

pilot burners

SIT

100 series











<b>GEV No.</b>	107141	<b>Ref. No.</b>	RTCU700372
<b>description</b>	pilot burner SIT type 100 series 1 flame nozzle ø 0.35mm gas connection 6mm		
<b>For models:</b>	MG117-03-110XL		
<b>spare parts for</b>	107141		
	<b>GEV No.</b>	100885	<b>Ref. No.</b> —
	air mixing sleeve for pilot burner Qty 1 pcs		
	<b>GEV No.</b>	100905	<b>Ref. No.</b> —
	locking screw M10x1 for pipe ø 6mm Qty 1 pcs		
	<b>GEV No.</b>	107160	<b>Ref. No.</b> —
	pilot burner cap SIT 1 flame Hmm Lmm Qty 1 pcs		
	<b>GEV No.</b>	107166	<b>Ref. No.</b> —
	pilot burner head SIT 1 flame Hmm Lmm Qty 1 pcs		
<b>accessories for</b>	107141		
	<b>GEV No.</b>	100904	<b>Ref. No.</b> —
	locking screw M10x1 for pipe ø 4mm Qty 1 pcs		
	<b>GEV No.</b>	106733	<b>Ref. No.</b> 172882
	pilot burner bracket suitable for MBM		
	<b>GEV No.</b>	107167	<b>Ref. No.</b> —
	pilot burner nozzle SIT LPG code 21 bore ø 0.21mm Qty 1 pcs		

Table continues overleaf

Зиг-Общепит

vsezip.ru







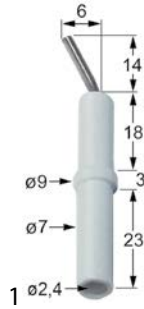





+7(812)987-08-81

<b>accessories for</b>	107141			
	GEV No.	107168	Ref. No.	—
	pilot burner nozzle SIT natural gas bore $\varnothing$ 0.35mm Qty 1 pcs thread M4x0.75 WS 5			

<b>accessories</b>			
<b>pilot burner nozzles</b>			
			
<b>GEV No.</b>	100245	<b>Ref. No.</b>	4370001
<b>description</b>	pilot burner nozzle LPG code 20 bore $\varnothing$ 0.2mm Qty 1 pcs thread M8x0.75		

<b>ignition electrodes</b>			
			
<b>GEV No.</b>	100707	<b>Ref. No.</b>	RTCP800033
<b>description</b>	ignition electrode D1 $\varnothing$ 7mm D2 $\varnothing$ 9mm connection $\varnothing$ 2.4mm L1 14mm L2 6mm BL1 18mm BL2 3mm BL3 23mm to clip Qty 1 pcs		
<b>For models:</b>	MG046-03-001, MG046-03-002, MG046-03-003, MG046-13-001, MG046-13-002, MG066-03-003, MG066-03-004, MG066-03-005, MG066-03-006, MG066-03-015, MG066-13-003, MG066-13-004, MG066-13-005, MG077-03-003, MG077-03-004, MG077-03-005, MG077-13-003, MG077-13-004, MG077-13-005, MG086-13-014P, MG099-03-012, MG099-03-012M, MG099-13-012I, MG099-13-012IM, MG106-03-003, MG106-03-004, MG106-13-003, MG106-13-004, MG117-03-110XL		

<b>140 - 145 - 150 series</b>				
				
<b>GEV No.</b>	107133	<b>Ref. No.</b>	RTCP800034	
<b>description</b>	pilot burner SIT type 140 series 1 flame nozzle $\varnothing$ mm gas connectionmm			
<b>For models:</b>	MG046-03-001, MG046-03-002, MG046-03-003, MG046-13-001, MG046-13-002, MG066-03-003, MG066-03-004, MG066-03-005, MG066-03-006, MG066-03-015, MG066-13-003, MG066-13-004, MG066-13-005, MG077-03-003, MG077-03-004, MG077-03-005, MG077-13-003, MG077-13-004, MG077-13-005, MG086-13-014P, MG099-03-012, MG099-03-012M, MG099-13-012I, MG099-13-012IM, MG106-03-003, MG106-03-004, MG106-13-003, MG106-13-004, MG117-03-110XL			
<b>accessories for</b>	107133			
	GEV No.	100204	Ref. No.	—
	pilot burner nozzle SIT LPG code 14 bore $\varnothing$ 0.18/0.20mm Qty 1 pcs suitable for 140 series			
	GEV No.	100205	Ref. No.	RTCP800041
	pilot burner nozzle SIT LPG code 19 bore $\varnothing$ 0.23/0.26mm Qty 1 pcs suitable for SIT 150 series			

<b>accessories for</b>	107133			
	GEV No.	100206	Ref. No.	RTCP800040
	pilot burner nozzle SIT natural gas code 36 bore $\varnothing$ 0.60/0.55mm Qty 1 pcs suitable for SIT 150 series			
	GEV No.	100207	Ref. No.	RTCP800059
	pilot burner nozzle SIT natural gas code 27 bore $\varnothing$ 0.40/0.38mm suitable for SIT 150 series			
	GEV No.	100216	Ref. No.	—
	pilot burner nozzle SIT natural gas code 38 bore $\varnothing$ 0.45mm Qty 1 pcs suitable for SIT 150 series			
	GEV No.	100701	Ref. No.	RTCU900010
	ignition electrode connection M4 Qty 1 pcs			
	GEV No.	100897	Ref. No.	—
	olive for pipe $\varnothing$ 4mm Qty 1 pcs for pilot burner			
	GEV No.	100898	Ref. No.	RTCU800183
	olive for pipe $\varnothing$ 6mm Qty 1 pcs for pilot burner			
	GEV No.	100906	Ref. No.	—
	screw connection thread M10x1 for ignition electrode brass Qty 1 pcs WS 10			
	GEV No.	100907	Ref. No.	—
	screw connection thread M10x1 Qty 1 pcs type SEF 1 $\varnothing$ mm for thermocouple			
	GEV No.	100908	Ref. No.	RTCU900133
	union screw thread M10x1 for pipe $\varnothing$ 4mm Qty 1 pcs			
	GEV No.	100909	Ref. No.	RTCP800038 RTCU900019
	union screw thread M10x1 for pipe $\varnothing$ 6mm Qty 1 pcs			
	GEV No.	102110	Ref. No.	—
	pilot tube copper pipe $\varnothing$ 4mm thickness 1mm L 3000mm			
	GEV No.	102111	Ref. No.	—
	pilot tube copper pipe $\varnothing$ 6mm thickness 1mm L 3000mm			

<b>160 series</b>				
				
<b>GEV No.</b>	100056	<b>Ref. No.</b>	RTCU700464	
<b>description</b>	pilot burner SIT type 160 series 3 flames nozzle $\varnothing$ mm gas connectionmm			
<b>For models:</b>	MG046-03-004, MG066-03-007, MG066-03-008			
<b>spare parts for</b>	100056			
	GEV No.	100907	Ref. No.	—
	screw connection thread M10x1 Qty 1 pcs type SEF 1 $\varnothing$ mm for thermocouple			
<b>accessories for</b>	100056			
	GEV No.	100202	Ref. No.	—
	pilot burner nozzle natural gas code 41 Qty 1 pcs nozzle $\varnothing$ 0.41mm			
	GEV No.	100203	Ref. No.	—
	pilot burner nozzle LPG code 25 Qty 1 pcs nozzle $\varnothing$ 0.25mm			

Table continues overleaf



Зип-Общепит

electrodes

vsezip.ru

+7(812)987-08-81

accessories for		100056	
	GEV No.	100701	Ref. No. RTCU900010
ignition electrode connection M4 Qty 1 pcs			
	GEV No.	100801	Ref. No. —
gasket for pilot burner Qty 1 pcs			
	GEV No.	100869	Ref. No. —
pilot burner nozzle natural gas code 51 Qty 1 pcs suitable for 160 series nozzle $\varnothing$ 0.51 mm			
	GEV No.	100870	Ref. No. RTCU900134
olive for pipe $\varnothing$ 4mm Qty 1 pcs suitable for 160 series for pilot burner			
	GEV No.	100906	Ref. No. —
screw connection thread M10x1 for ignition electrode brass Qty 1 pcs WS 10			
	GEV No.	100908	Ref. No. RTCU900133
union screw thread M10x1 for pipe $\varnothing$ 4mm Qty 1 pcs			
	GEV No.	100909	Ref. No. RTCP800038 RTCU900019
union screw thread M10x1 for pipe $\varnothing$ 6mm Qty 1 pcs			
	GEV No.	101287	Ref. No. —
olive for pipe $\varnothing$ 6mm Qty 1 pcs			
	GEV No.	102110	Ref. No. —
pilot tube copper pipe $\varnothing$ 4mm thickness 1mm L 3000mm			
	GEV No.	102111	Ref. No. —
pilot tube copper pipe $\varnothing$ 6mm thickness 1mm L 3000mm			
	GEV No.	107650	Ref. No. —
pilot burner nozzle SIT LPG code 30 Qty 1 pcs			

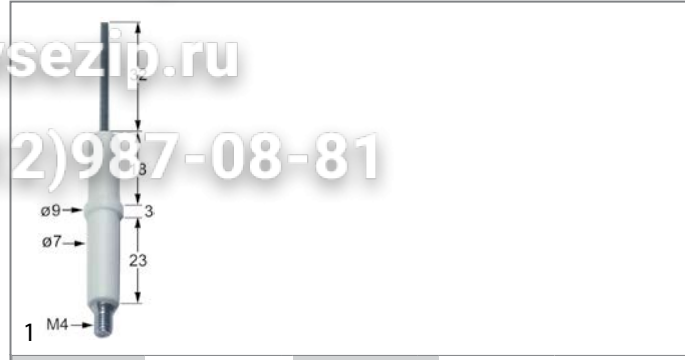

GEV No.	100701	Ref. No.	RTCU900010
<b>description</b>	ignition electrode connection M4 Qty 1 pcs		
<b>For models:</b>	MG046-03-004, MG066-03-007, MG066-03-008		
<b>accessories for</b>	100701		
	GEV No.	100906	Ref. No. —
screw connection thread M10x1 for ignition electrode brass Qty 1 pcs WS 10			

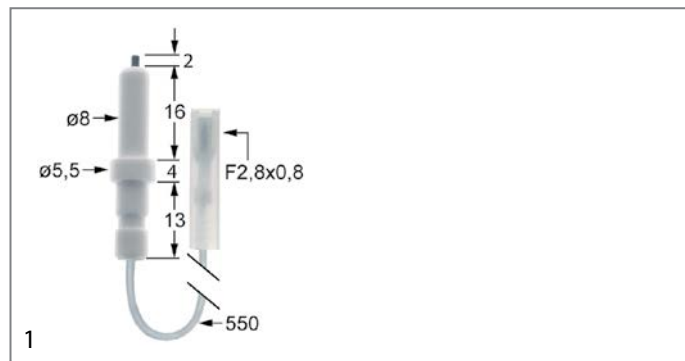

GEV No.	100808	Ref. No.	RTCU600045
<b>description</b>	ignition electrode D1 $\varnothing$ 5.5mm cable length 550mm connection F 2.8x0.8mm D2 $\varnothing$ 8mm L1 2mm BL1 16mm BL2 4mm BL3 13mm		
<b>For models:</b>	ME066-03-010, ME106-03-010XL, MG046-03-000, MG066-03-000, MG066-03-010, MG106-03-000, MG106-03-010, MG106-03-010XL		

accessories universal

pilot burner brackets



GEV No.	690798	Ref. No.	PACU701022
<b>description</b>	pilot burner bracket		
<b>For models:</b>	MG099-03-012, MG099-03-012M, MG099-13-012I, MG099-13-012IM		

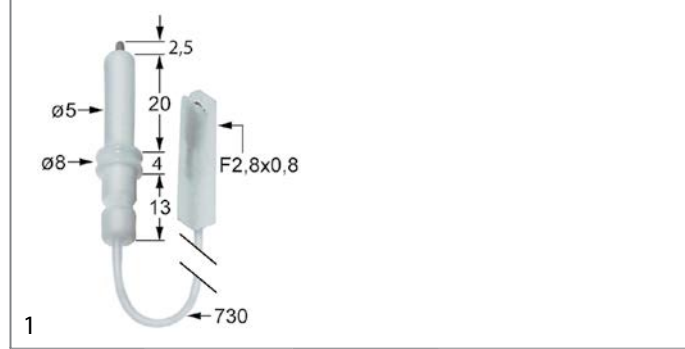

GEV No.	100826	Ref. No.	RTCU600046
<b>description</b>	ignition electrode D1 $\varnothing$ 5mm cable length 730mm connection F 2.8x0.8mm D2 $\varnothing$ 8mm L1 2.5mm BL1 20mm BL2 4mm BL3 13mm		
<b>For models:</b>	ME066-03-010, ME106-03-010XL, MG046-03-000, MG066-03-000, MG066-03-010, MG106-03-000, MG106-03-010, MG106-03-010XL		

Зип Общепит  
ignition cables

pre-assembled cables  
vsezip.ru

+7(812)9870881

<b>GEV No.</b>	100707	<b>Ref. No.</b>	RTCP800033
<b>description</b>	ignition electrode D1 ø 7mm D2 ø 9mm connection ø2.4mm L1 14mm L2 6mm BL1 18mm BL2 3mm BL3 23mm to clip Qty 1 pcs		
<b>For models:</b>	MG046-03-001, MG046-03-002, MG046-03-003, MG046-13-001, MG046-13-002, MG066-03-003, MG066-03-004, MG066-03-005, MG066-03-006, MG066-03-015, MG066-13-003, MG066-13-004, MG066-13-005, MG077-03-003, MG077-03-004, MG077-03-005, MG077-13-003, MG077-13-004, MG077-13-005, MG086-13-014P, MG099-03-012, MG099-03-012M, MG099-13-012I, MG099-13-012IM, MG106-03-003, MG106-03-004, MG106-13-003, MG106-13-004, MG117-03-110XL		

<b>GEV No.</b>	100818	<b>Ref. No.</b>	9353457100 RIC0002551
<b>description</b>	ignition electrode flange length 23mm flange width 15mm D1 ø 7mm L1 18mm BL1 12mm BL2 41mm connection F 2.8x0.8mm fixing dimensions ø5x4mm with flange		
<b>For models:</b>	MG066-03-010, MG106-03-010, MG106-03-010XL		

<b>GEV No.</b>	106068	<b>Ref. No.</b>	RTCU600047
<b>description</b>	spring clip for igniter		
<b>For models:</b>	ME066-03-010, ME106-03-010XL, MG066-03-010, MG106-03-010, MG106-03-010XL		

<b>GEV No.</b>	106797	<b>Ref. No.</b>	RTCU900215
<b>description</b>	union screw thread M10x1 WS 10 bore ø 7.3mm		
<b>For models:</b>	MG099-03-012, MG099-03-012M, MG099-13-012I, MG099-13-012IM, MG117-03-110XL		

<b>GEV No.</b>	100026	<b>Ref. No.</b>	RTCU900384
<b>description</b>	ignition cable cable length 1000mm connection ø4mm / F6.3mm		
<b>For models:</b>	MG046-03-003, MG066-03-006		

<b>GEV No.</b>	100174	<b>Ref. No.</b>	9363490000 RIC0002554
<b>description</b>	ignition cable cable length 1500mm connection F2.8mm / F2.8mm		
<b>For models:</b>	MG066-03-010, MG106-03-010, MG106-03-010XL		

<b>GEV No.</b>	102163	<b>Ref. No.</b>	RTCU700005
<b>description</b>	ignition cable cable length 1500mm connection F2.8mm / ø2.4mm		
<b>For models:</b>	MG099-03-012, MG099-03-012M, MG099-13-012I, MG099-13-012IM		

<b>GEV No.</b>	100014	<b>Ref. No.</b>	RTCU700361
<b>description</b>	ignition cable cable length 300mm connection ø2.4mm / ø2.4mm		
<b>For models:</b>	MG046-03-001, MG046-03-002, MG046-13-001, MG046-13-002, MG066-03-003, MG066-03-004, MG066-03-005, MG066-03-015, MG066-13-003, MG066-13-004, MG066-13-005, MG077-03-003, MG077-03-004, MG077-03-005, MG077-13-003, MG077-13-004, MG077-13-005, MG086-13-014P, MG106-03-003, MG106-03-004, MG106-13-003, MG106-13-004		

<b>GEV No.</b>	100178	<b>Ref. No.</b>	RTBF700023
<b>description</b>	ignition cable cable length 900mm connection F2.8mm / ø2.4mm		
<b>For models:</b>	MG046-03-004, MG066-03-007, MG066-03-008		

piezoelectric igniters  
mounting diameter 22mm

<b>GEV No.</b>	100005	<b>Ref. No.</b>	RTCU700020
<b>description</b>	piezoelectric igniter body plastic blowing mounting ø 22mm connection ø2.4mm cable lengthmm SIT		
<b>For models:</b>	MG046-03-000, MG046-03-001, MG046-03-002, MG046-03-003, MG046-03-004, MG046-13-001, MG046-13-002, MG066-03-000, MG066-03-003, MG066-03-004, MG066-03-005, MG066-03-006, MG066-03-007, MG066-03-008, MG066-03-015, MG066-13-003, MG066-13-004, MG066-13-005, MG077-03-003, MG077-03-004, MG077-03-005, MG077-13-003, MG077-13-004, MG077-13-005, MG086-13-014P, MG106-03-000, MG106-03-003, MG106-03-004, MG106-13-003, MG106-13-004, MG117-03-110XL		



ignition units

Зип Общепит

vsezip.ru

+7(812)987-08-81



1

<b>GEV No.</b>	102485	<b>Ref. No.</b>	RTBF800129
<b>description</b>	ignition unit outputs 2 220-240VAC 0.6VA 50-60Hz		
<b>For models:</b>	ME106-03-010XL, MG066-03-010, MG099-03-012, MG099-03-012M, MG099-13-012I, MG099-13-012IM, MG106-03-010, MG106-03-010XL		



1

<b>GEV No.</b>	102922	<b>Ref. No.</b>	RTCU600190
<b>description</b>	ignition unit outputs 4		
<b>For models:</b>	ME066-03-010, MG066-03-010		

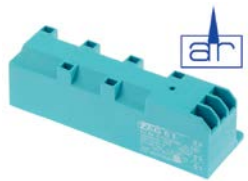

1

<b>GEV No.</b>	101024	<b>Ref. No.</b>	RTCU600191
<b>description</b>	ignition unit outputs 6 230VAC dimensions 112x22x34mm mounting distance 98mm inlet F6.3x0.8 outlet F2.8x0.8 type ZAG6 0.3VA 50/60Hz t.max. -20 up to +125°C		
<b>For models:</b>	ME106-03-010XL, MG106-03-010, MG106-03-010XL		

thermocouples

plug-in thermocouples

plug-in thermocouples standard

with barrel socket ø6mm

SIT

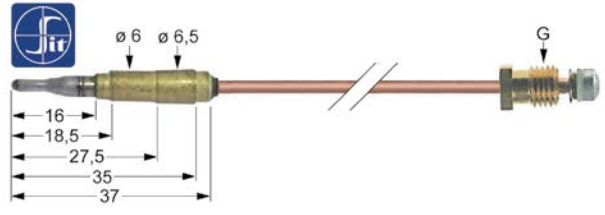

1

<b>GEV No.</b>	102923	<b>Ref. No.</b>	RTCU700296
<b>description</b>	thermocouple M9x1 L 750mm plug connection ø6.0mm		
<b>For models:</b>	MG046-03-001, MG046-03-002, MG046-03-003, MG046-13-001, MG046-13-002, MG066-03-003, MG066-03-004, MG066-03-005, MG066-03-006, MG066-03-015, MG066-13-003, MG066-13-004, MG066-13-005, MG077-03-003, MG077-03-004, MG077-03-005, MG077-13-003, MG077-13-004, MG077-13-005, MG106-03-003, MG106-03-004, MG106-13-003, MG106-13-004		

with barrel socket ø6(6.5)mm

thermocouples SIT

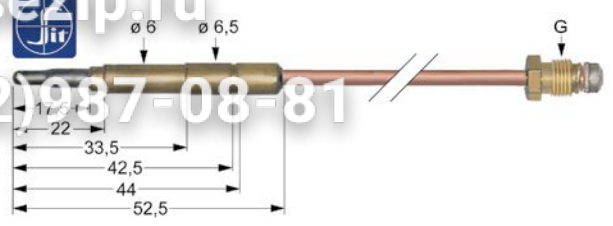

1

<b>GEV No.</b>	107613	<b>Ref. No.</b>	RTCU900061
<b>description</b>	thermocouple SIT M9x1 L 1200mm plug connection ø6.0(6.5)mm		
<b>For models:</b>	MG117-03-110XL		

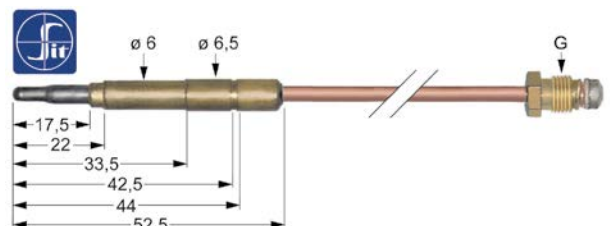

1

<b>GEV No.</b>	107608	<b>Ref. No.</b>	RTCU700148 RTCU900477
<b>description</b>	thermocouple SIT M9x1 L 500mm plug connection ø6.0(6.5)mm		
<b>For models:</b>	MG066-03-008, MG086-13-014P		

plug-in thermocouples with interruption

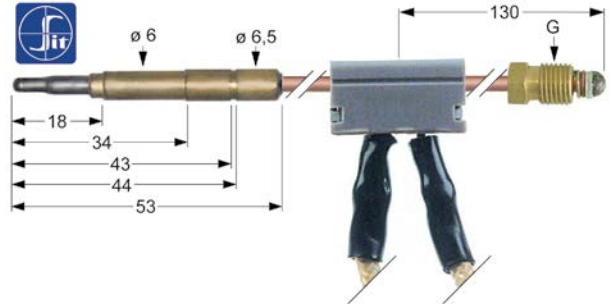

1

<b>GEV No.</b>	107863	<b>Ref. No.</b>	RTCU700651
<b>description</b>	thermocouple SIT with interrupter M9x1 L 1000mm plug connection ø6.0(6.5)mm cable 820mm		
<b>For models:</b>	MG046-03-004, MG066-03-007		

Зип-Общепит

vsezip.ru

+7(812)987-08-81

threaded thermocouples

threaded thermocouples standard

with socket with thread M8x1

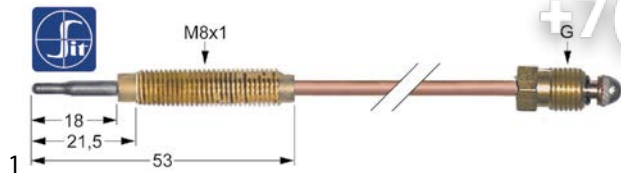

SIT



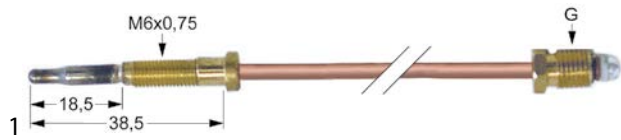

<b>GEV No.</b>	107633	<b>Ref. No.</b>	9606014100 RIC0002552
<b>description</b>	thermocouple SIT M8x1 L 1200mm M8x1		
<b>For models:</b>	MG066-03-010, MG106-03-010, MG106-03-010XL		
<b>accessories for</b>	107633		
	<b>GEV No.</b>	102067	<b>Ref. No.</b> 9404701700
	nut thread M8x1 H 3mm brass Qty 1 pcs type SEF 1		

threaded thermocouples (miscellaneous)

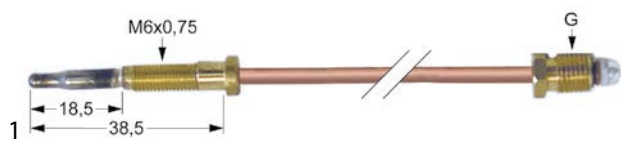

<b>GEV No.</b>	102138	<b>Ref. No.</b>	RTCU700373
<b>description</b>	thermocouple M9x1 L 300mm M6x0.75		
<b>For models:</b>	MG117-03-110XL		
<b>accessories for</b>	102138		
	<b>GEV No.</b>	102143	<b>Ref. No.</b> RTCU700391
	thermocouple nut thread M6x0.75 H 12mm WS 8 brass Qty 1 pcs		
	<b>GEV No.</b>	102680	<b>Ref. No.</b> RTCU600052
	nut thread M6x0.75 H 2.6mm WS 8 brass Qty 1 pcs type SEF 2		



<b>GEV No.</b>	102139	<b>Ref. No.</b>	RTCU700374
<b>description</b>	thermocouple M9x1 L 500mm M6x0.75		
<b>For models:</b>	MG117-03-110XL		
<b>accessories for</b>	102139		
	<b>GEV No.</b>	102143	<b>Ref. No.</b> RTCU700391
	thermocouple nut thread M6x0.75 H 12mm WS 8 brass Qty 1 pcs		

threaded thermocouples with cable link

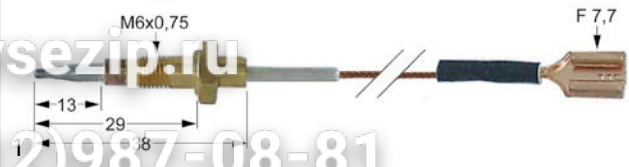

<b>GEV No.</b>	102243	<b>Ref. No.</b>	RTCU600021
<b>description</b>	thermocouple L 600mm		
<b>For models:</b>	ME066-03-010, ME106-03-010XL, MG046-03-000, MG066-03-000, MG066-03-010, MG106-03-000, MG106-03-010, MG106-03-010XL		



<b>GEV No.</b>	102924	<b>Ref. No.</b>	RTCU600039
<b>description</b>	thermocouple with two-conductors L 750mm M6x0.75 F 7.7mm M4		
<b>For models:</b>	ME066-03-010, ME106-03-010XL, MG046-03-000, MG066-03-000, MG066-03-010, MG106-03-000, MG106-03-010, MG106-03-010XL		

accessories

nuts



<b>GEV No.</b>	102067	<b>Ref. No.</b>	9404701700
<b>description</b>	nut thread M8x1 H 3mm brass Qty 1 pcs type SEF 1		
<b>For models:</b>	MG066-03-010, MG106-03-010, MG106-03-010XL		



<b>GEV No.</b>	102143	<b>Ref. No.</b>	RTCU700391
<b>description</b>	thermocouple nut thread M6x0.75 H 12mm WS 8 brass Qty 1 pcs		
<b>For models:</b>	MG117-03-110XL		







gas burners





hob burners



universal hob burners

SABAF

2 series - standard

 <p>1</p>			
<b>GEV No.</b>	105054	<b>Ref. No.</b>	RTCU600044
<b>description</b>	burner cap 3kW ø 100mm H 3.5mm bright finish		
<b>For models:</b>	ME066-03-010, ME106-03-010XL, MG046-03-000, MG066-03-000, MG066-03-010, MG106-03-000, MG106-03-010, MG106-03-010XL		
<b>accessories for</b>	105054		
 <p>GEV No. 105058 Ref. No. RTCU600043</p> <p>burner head 3kW for igniter ø 6mm for burner cap ø 100mm</p>			
 <p>GEV No. 105059 Ref. No. RTCU600017</p> <p>burner lower part 3kW for igniter ø 6mm for thermocouple ø 6mm without nozzle for burner cap ø 100mm</p>			

 <p>1</p>			
<b>GEV No.</b>	105058	<b>Ref. No.</b>	RTCU600043
<b>description</b>	burner head 3kW for igniter ø 6mm for burner cap ø 100mm		
<b>For models:</b>	ME066-03-010, ME106-03-010XL, MG046-03-000, MG066-03-000, MG066-03-010, MG106-03-000, MG106-03-010, MG106-03-010XL		
<b>accessories for</b>	105058		
 <p>GEV No. 105054 Ref. No. RTCU600044</p> <p>burner cap 3kW ø 100mm H 3.5mm bright finish</p>			
 <p>GEV No. 105059 Ref. No. RTCU600017</p> <p>burner lower part 3kW for igniter ø 6mm for thermocouple ø 6mm without nozzle for burner cap ø 100mm</p>			
 <p>GEV No. 107374 Ref. No. —</p> <p>burner cap 3kW ø 100mm H 3.5mm matt finish</p>			



 <p>1</p>			
<b>GEV No.</b>	105059	<b>Ref. No.</b>	RTCU600017
<b>description</b>	burner lower part 3kW for igniter ø 6mm for thermocouple ø 6mm without nozzle for burner cap ø 100mm		
<b>For models:</b>	ME066-03-010, ME106-03-010XL, MG046-03-000, MG066-03-000, MG066-03-010, MG106-03-000, MG106-03-010, MG106-03-010XL		
<b>accessories for</b>	105059		
 <p>GEV No. 105054 Ref. No. RTCU600044</p> <p>burner cap 3kW ø 100mm H 3.5mm bright finish</p>			
 <p>GEV No. 105058 Ref. No. RTCU600043</p> <p>burner head 3kW for igniter ø 6mm for burner cap ø 100mm</p>			

Зип-Общепит

vsezip.ru

+7(812)987-08-81

accessories for 105059			
<b>GEV No.</b>	107374	<b>Ref. No.</b>	—
burner cap 3kW ø 100mm H 3.5mm matt finish			

2 series - flat skirt version			
 <p>1</p>			
<b>GEV No.</b>	105054	<b>Ref. No.</b>	RTCU600044
<b>description</b>	burner cap 3kW ø 100mm H 3.5mm bright finish		
<b>For models:</b>	ME066-03-010, ME106-03-010XL, MG046-03-000, MG066-03-000, MG066-03-010, MG106-03-000, MG106-03-010, MG106-03-010XL		
<b>accessories for</b>	105054		
 <p>GEV No. 105058 Ref. No. RTCU600043</p> <p>burner head 3kW for igniter ø 6mm for burner cap ø 100mm</p>			
 <p>GEV No. 105059 Ref. No. RTCU600017</p> <p>burner lower part 3kW for igniter ø 6mm for thermocouple ø 6mm without nozzle for burner cap ø 100mm</p>			

 <p>1</p>			
<b>GEV No.</b>	105059	<b>Ref. No.</b>	RTCU600017
<b>description</b>	burner lower part 3kW for igniter ø 6mm for thermocouple ø 6mm without nozzle for burner cap ø 100mm		
<b>For models:</b>	ME066-03-010, ME106-03-010XL, MG046-03-000, MG066-03-000, MG066-03-010, MG106-03-000, MG106-03-010, MG106-03-010XL		
<b>accessories for</b>	105059		
 <p>GEV No. 105054 Ref. No. RTCU600044</p> <p>burner cap 3kW ø 100mm H 3.5mm bright finish</p>			
 <p>GEV No. 105058 Ref. No. RTCU600043</p> <p>burner head 3kW for igniter ø 6mm for burner cap ø 100mm</p>			
 <p>GEV No. 107374 Ref. No. —</p> <p>burner cap 3kW ø 100mm H 3.5mm matt finish</p>			



triple ring burner series - standard version			
 <p>1</p>			
<b>GEV No.</b>	105063	<b>Ref. No.</b>	RTCU600040
<b>description</b>	burner cap 3.6kW ø 131mm H 4mm mounting pos. outer		
<b>For models:</b>	ME066-03-010, ME106-03-010XL, MG046-03-000, MG066-03-000, MG066-03-010, MG106-03-000, MG106-03-010, MG106-03-010XL		
<b>accessories for</b>	105063		
 <p>GEV No. 105064 Ref. No. RTCU600041</p> <p>burner cap 3.6kW ø 61mm H 6.5mm mounting pos. inner bright finish</p>			
 <p>GEV No. 105065 Ref. No. RTCU600042</p> <p>burner head 3.6kW for burner cap ø 61/131mm</p>			



Table continues overleaf

1 gas components

Зип Общепит



vsezip.ru

7(812)987-08381

<b>accessories for</b> 105063			
	GEV No.	105717	Ref. No. —
burner lower part 3.6kW for igniter ø 6mm for thermocouple ø 6mm with nozzle ø1.35mm ID ø 64mm for burner cap ø 61/131mm			
	GEV No.	105922	Ref. No. —
burner lower part 3.6kW for igniter ø 6mm for thermocouple ø 6mm with nozzle ø1.35mm ID ø 75mm for burner cap ø 61/131mm			

			
<b>GEV No.</b>	105064	<b>Ref. No.</b>	RTCU600041
<b>description</b>	burner cap 3.6kW ø 61mm H 6.5mm mounting pos. inner bright finish		
<b>For models:</b>	ME066-03-010, ME106-03-010XL, MG046-03-000, MG066-03-000, MG066-03-010, MG106-03-000, MG106-03-010, MG106-03-010XL		
<b>accessories for</b> 105064			
	GEV No.	105063	Ref. No. RTCU600040
burner cap 3.6kW ø 131mm H 4mm mounting pos. outer			
	GEV No.	105065	Ref. No. RTCU600042
burner head 3.6kW for burner cap ø 61/131mm			
	GEV No.	105717	Ref. No. —
burner lower part 3.6kW for igniter ø 6mm for thermocouple ø 6mm with nozzle ø1.35mm ID ø 64mm for burner cap ø 61/131mm			
	GEV No.	105922	Ref. No. —
burner lower part 3.6kW for igniter ø 6mm for thermocouple ø 6mm with nozzle ø1.35mm ID ø 75mm for burner cap ø 61/131mm			

			
<b>GEV No.</b>	105065	<b>Ref. No.</b>	RTCU600042
<b>description</b>	burner head 3.6kW for burner cap ø 61/131mm		
<b>For models:</b>	ME066-03-010, ME106-03-010XL, MG046-03-000, MG066-03-000, MG066-03-010, MG106-03-000, MG106-03-010, MG106-03-010XL		
<b>accessories for</b> 105065			
	GEV No.	105063	Ref. No. RTCU600040
burner cap 3.6kW ø 131mm H 4mm mounting pos. outer			
	GEV No.	105064	Ref. No. RTCU600041
burner cap 3.6kW ø 61mm H 6.5mm mounting pos. inner bright finish			
	GEV No.	105717	Ref. No. —
burner lower part 3.6kW for igniter ø 6mm for thermocouple ø 6mm with nozzle ø1.35mm ID ø 64mm for burner cap ø 61/131mm			

			
<b>GEV No.</b>	105123	<b>Ref. No.</b>	RTCU600018
<b>description</b>	burner lower part 3.6kW for igniter ø 7mm for thermocouple ø 6mm with nozzle ø1.35mm ID ø 75mm for burner cap ø 61/131mm		
<b>For models:</b>	ME066-03-010, ME106-03-010XL, MG046-03-000, MG066-03-000, MG066-03-010, MG106-03-000, MG106-03-010, MG106-03-010XL		
<b>accessories for</b> 105123			
	GEV No.	105124	Ref. No. —
burner head 3.6kW for burner cap ø 61/131mm			
	GEV No.	105125	Ref. No. —
burner cap 3.6kW ø 131mm H 7mm mounting pos. outer			
	GEV No.	105126	Ref. No. —
burner cap 3.6kW ø 61mm H 9mm mounting pos. inner matt finish			

triple ring burner series - flat skirt version

			
<b>GEV No.</b>	105063	<b>Ref. No.</b>	RTCU600040
<b>description</b>	burner cap 3.6kW ø 131mm H 4mm mounting pos. outer		
<b>For models:</b>	ME066-03-010, ME106-03-010XL, MG046-03-000, MG066-03-000, MG066-03-010, MG106-03-000, MG106-03-010, MG106-03-010XL		
<b>accessories for</b> 105063			
	GEV No.	105064	Ref. No. RTCU600041
burner cap 3.6kW ø 61mm H 6.5mm mounting pos. inner bright finish			
	GEV No.	105065	Ref. No. RTCU600042
burner head 3.6kW for burner cap ø 61/131mm			
	GEV No.	105717	Ref. No. —
burner lower part 3.6kW for igniter ø 6mm for thermocouple ø 6mm with nozzle ø1.35mm ID ø 64mm for burner cap ø 61/131mm			
	GEV No.	105922	Ref. No. —
burner lower part 3.6kW for igniter ø 6mm for thermocouple ø 6mm with nozzle ø1.35mm ID ø 75mm for burner cap ø 61/131mm			





			
<b>GEV No.</b>	105064	<b>Ref. No.</b>	RTCU600041
<b>description</b>	burner cap 3.6kW ø 61mm H 6.5mm mounting pos. inner bright finish		
<b>For models:</b>	ME066-03-010, ME106-03-010XL, MG046-03-000, MG066-03-000, MG066-03-010, MG106-03-000, MG106-03-010, MG106-03-010XL		
<b>accessories for</b> 105064			
	GEV No.	105063	Ref. No. RTCU600040
burner cap 3.6kW ø 131mm H 4mm mounting pos. outer			
	GEV No.	105065	Ref. No. RTCU600042
burner head 3.6kW for burner cap ø 61/131mm			

Table continues overleaf





Зип Общепит  
vsezip.ru  
7(812)987-08-81

<b>accessories for</b>	105064		
	<b>GEV No.</b>	105717	<b>Ref. No.</b> —
	burner lower part 3.6kW for igniter ø 6mm for thermocouple ø 6mm with nozzle ø1.35mm ID ø 64mm for burner cap ø 61/131mm		
	<b>GEV No.</b>	105922	<b>Ref. No.</b> —
	burner lower part 3.6kW for igniter ø 6mm for thermocouple ø 6mm with nozzle ø1.35mm ID ø 75mm for burner cap ø 61/131mm		



<b>GEV No.</b>	105123	<b>Ref. No.</b>	RTCU600018
<b>description</b>	burner lower part 3.6kW for igniter ø 7mm for thermocouple ø 6mm with nozzle ø1.35mm ID ø 75mm for burner cap ø 61/131mm		
<b>For models:</b>	ME066-03-010, ME106-03-010XL, MG046-03-000, MG066-03-000, MG066-03-010, MG106-03-000, MG106-03-010, MG106-03-010XL		

<b>accessories for</b>	105123		
	<b>GEV No.</b>	105124	<b>Ref. No.</b> —
	burner head 3.6kW for burner cap ø 61/131mm		
	<b>GEV No.</b>	105125	<b>Ref. No.</b> —
	burner cap 3.6kW ø 131mm H 7mm mounting pos. outer		
	<b>GEV No.</b>	105126	<b>Ref. No.</b> —
	burner cap 3.6kW ø 61mm H 9mm mounting pos. inner matt finish		

**accessories**  
reducers for pan supports



<b>GEV No.</b>	210050	<b>Ref. No.</b>	RTCU700028
<b>description</b>	reducer for pan support L 260mm W 260mm chrome-plated steel suitable for universal		
<b>For models:</b>	MG117-03-110XL		

**pan supports**



<b>GEV No.</b>	210174	<b>Ref. No.</b>	RTCU600019
<b>description</b>	pan support W 285mm L 505mm		
<b>For models:</b>	ME066-03-010, ME106-03-010XL, MG066-03-000, MG066-03-010, MG106-03-000, MG106-03-010, MG106-03-010XL		



<b>GEV No.</b>	210242	<b>Ref. No.</b>	RTCU600020
<b>description</b>	pan support W 340mm L 515mm		
<b>For models:</b>	ME106-03-010XL, MG046-03-000, MG106-03-000, MG106-03-010, MG106-03-010XL		

**bar burners**

**bar burners**



<b>GEV No.</b>	105194	<b>Ref. No.</b>	RIC0002462
<b>description</b>	bar burner		
<b>For models:</b>	MG066-03-010		



<b>GEV No.</b>	105211	<b>Ref. No.</b>	RTCU600070
<b>description</b>	bar burner 2 row L 470mm W 200mm ømm H 45mm chargrill		
<b>For models:</b>	MG086-13-014P		



<b>GEV No.</b>	105208	<b>Ref. No.</b>	RTCU700279
<b>description</b>	bar burner 2 row L 488mm W 250mm ømm H 170mm griddle		
<b>For models:</b>	MG077-03-003, MG077-03-004, MG077-03-005, MG077-13-003, MG077-13-004, MG077-13-005		



<b>GEV No.</b>	105706	<b>Ref. No.</b>	RTBF900098
<b>description</b>	bar burner 6 row L 518mm W 630mm ømm H 305mm tilting bratt pan		
<b>For models:</b>	MG099-03-012, MG099-03-012M, MG099-13-012L, MG099-13-012IM		





Зип Общепит

vsezip.ru

+7(812)9870881

			
1			
<b>GEV No.</b>	105219	<b>Ref. No.</b>	RTCU700320
<b>description</b>	bar burner ø 40mm Wmm Hmm L 192mm flange ø 61mm bain marie		
<b>For models:</b>	MG046-03-003		

			
1			
<b>GEV No.</b>	105220	<b>Ref. No.</b>	RTCU700321
<b>description</b>	bar burner ø 40mm Wmm Hmm L 310mm flange ø 61mm bain marie		
<b>For models:</b>	MG066-03-006		

			
1			
<b>GEV No.</b>	105213	<b>Ref. No.</b>	RTCU600150
<b>description</b>	bar burner ø 40mm Wmm Hmm L 310mm flange ø 61mm frying pan		
<b>For models:</b>	MG066-03-015		

			
1			
<b>GEV No.</b>	105207	<b>Ref. No.</b>	RTCU600003
<b>description</b>	bar burner ø 40mm Wmm Hmm L 405mm flange ø 61mm griddle		
<b>For models:</b>	MG046-03-001, MG046-03-002, MG046-13-001, MG046-13-002, MG066-03-003, MG066-03-004, MG066-03-005, MG066-13-003, MG066-13-004, MG066-13-005, MG106-03-003, MG106-03-004, MG106-13-003, MG106-13-004		

			
1			
<b>GEV No.</b>	210243	<b>Ref. No.</b>	RTCU600466
<b>description</b>	chargrill grid L 440mm W 355mm fish		
<b>For models:</b>	MG086-13-014P		

			
1			
<b>GEV No.</b>	210239	<b>Ref. No.</b>	A660000330
<b>description</b>	chargrill grid L 460mm W 350mm meat		
<b>For models:</b>	MG086-13-014P		

<b>chargrill grids</b>			
			
1			
<b>GEV No.</b>	210243	<b>Ref. No.</b>	RTCU600466
<b>description</b>	chargrill grid L 440mm W 355mm fish		
<b>For models:</b>	MG086-13-014P		

			
1			
<b>GEV No.</b>	210239	<b>Ref. No.</b>	A660000330
<b>description</b>	chargrill grid L 460mm W 350mm meat		
<b>For models:</b>	MG086-13-014P		

tube burners

			
1			
<b>GEV No.</b>	105214	<b>Ref. No.</b>	RTCU700465
<b>description</b>	tubular burner ø 74mm L 185mm H 60mm round for pasta cooker		
<b>For models:</b>	MG046-03-004, MG066-03-007, MG066-03-008		

accessories

<b>nozzle holders</b>			
			
1			
<b>GEV No.</b>	105184	<b>Ref. No.</b>	173320
<b>description</b>	nozzle holder		
<b>For models:</b>	MG117-03-110XL		



Зип Общепит  
pilot burner nozzles

vsezip.ru  
100 series

7(812)987-08-81

			
1			
<b>GEV No.</b>	106065	<b>Ref. No.</b>	RTCU900337
<b>description</b>	nozzle holder		
<b>For models:</b>	MG046-03-003, MG066-03-006, MG077-03-003, MG077-03-004, MG077-03-005, MG077-13-003, MG077-13-004, MG077-13-005, MG086-13-014P		

			
pilot burner nozzles SIT			
<b>GEV No.</b>	100245	<b>Ref. No.</b>	4370001
<b>description</b>	pilot burner nozzle LPG code 20 bore $\varnothing$ 0.2mm Qty 1 pcs thread M8x0.75		

## gas nozzles

### main nozzles

#### gas nozzles M6x0.75

			
1			
<b>GEV No.</b>	106731	<b>Ref. No.</b>	RTCU600093
<b>description</b>	gas injector thread M6x0.75 WS 7 bore $\varnothing$ 0.73mm		
<b>For models:</b>	ME066-03-010, ME106-03-010XL, MG066-03-010, MG106-03-010, MG106-03-010XL		

			
1			
<b>GEV No.</b>	106732	<b>Ref. No.</b>	RTCU600102
<b>description</b>	gas injector thread M6x0.75 WS 7 bore $\varnothing$ 0.74mm		
<b>For models:</b>	ME066-03-010, ME106-03-010XL, MG066-03-010, MG106-03-010, MG106-03-010XL		

#### gas nozzles M10x1

			
1			
<b>GEV No.</b>	100661	<b>Ref. No.</b>	290201850-R
<b>description</b>	gas injector thread M10x1 WS 12 bore $\varnothing$ 1.65mm		

#### gas nozzles M12x1

			
1			
<b>GEV No.</b>	100290	<b>Ref. No.</b>	RTCU900243
<b>description</b>	gas injector thread M12x1 WS 14 bore $\varnothing$ 1.90mm		
<b>For models:</b>	MG077-03-003, MG077-03-004, MG077-03-005, MG077-13-003, MG077-13-004, MG077-13-005		

#### 140/150 series

			
1			
<b>GEV No.</b>	100205	<b>Ref. No.</b>	RTCP800041
<b>description</b>	pilot burner nozzle SIT LPG code 19 bore $\varnothing$ 0.23/0.26mm Qty 1 pcs suitable for SIT 150 series		
<b>For models:</b>	MG099-03-012, MG099-03-012M, MG099-13-012I, MG099-13-012IM		

			
1			
<b>GEV No.</b>	100207	<b>Ref. No.</b>	RTCP800059
<b>description</b>	pilot burner nozzle SIT natural gas code 27 bore $\varnothing$ 0.40/0.38mm suitable for SIT 140 series		
<b>For models:</b>	MG077-03-003, MG077-03-004, MG077-03-005, MG077-13-003, MG077-13-004, MG077-13-005		

			
1			
<b>GEV No.</b>	100206	<b>Ref. No.</b>	RTCP800040
<b>description</b>	pilot burner nozzle SIT natural gas code 36 bore $\varnothing$ 0.60/0.55mm Qty 1 pcs suitable for SIT 150 series		
<b>For models:</b>	MG099-03-012, MG099-03-012M, MG099-13-012I, MG099-13-012IM		

### bypass nozzles

#### bypass nozzles PEL20/21

			
1			
<b>GEV No.</b>	100394	<b>Ref. No.</b>	4399247-R
<b>description</b>	bypass nozzle type PEL20/21 bore $\varnothing$ 1.25mm thread M5x0.5		

			
1			
<b>GEV No.</b>	100534	<b>Ref. No.</b>	4399238-R
<b>description</b>	bypass nozzle type PEL20/21 bore $\varnothing$ 1.4mm thread M5x0.5		

			
1			
<b>GEV No.</b>	100529	<b>Ref. No.</b>	RTCU700338
<b>description</b>	bypass nozzle type PEL20/21 bore $\varnothing$ 1mm thread M5x0.5		



Зип Общепит

vsezip.ru

7(812)987-08-81

## bypass nozzles PEL22



1

<b>GEV No.</b>	100428	<b>Ref. No.</b>	RTCU800175
<b>description</b>	bypass nozzle type PEL22 bore $\varnothing$ 0.65mm thread M6x0.5		
<b>For models:</b>	MG077-03-003, MG077-03-004, MG077-03-005, MG077-13-003, MG077-13-004, MG077-13-005		

## auxiliary gas parts

## screw connections

## olives



1

<b>GEV No.</b>	101278	<b>Ref. No.</b>	RTCU900012
<b>description</b>	olive for pipe $\varnothing$ 10mm Qty 1 pcs		
<b>For models:</b>	MG046-03-003, MG046-03-004, MG066-03-006, MG066-03-007, MG066-03-008, MG077-03-003, MG077-03-004, MG077-03-005, MG077-13-003, MG077-13-004, MG077-13-005, MG099-03-012, MG099-03-012M, MG099-13-012I, MG099-13-012IM, MG117-03-110XL		

<b>accessories for</b>	101278	<b>GEV No.</b>	100943	<b>Ref. No.</b>	—
------------------------	--------	----------------	--------	-----------------	---

union nut thread M17x1 tube  $\varnothing$  10mm

<b>GEV No.</b>	101300	<b>Ref. No.</b>	RTCU700297
----------------	--------	-----------------	------------

union nut thread M16x1.5 tube  $\varnothing$  10mm

<b>GEV No.</b>	101478	<b>Ref. No.</b>	RTCU900013
----------------	--------	-----------------	------------

union nut thread 3/8" for pipe  $\varnothing$  10mm

1

<b>GEV No.</b>	106798	<b>Ref. No.</b>	RTCP900088
<b>description</b>	olive for pipe $\varnothing$ 14mm L 7mm brass Qty 1 pcs ED $\varnothing$ 16mm		
<b>For models:</b>	MG099-03-012, MG099-03-012M, MG099-13-012I, MG099-13-012IM		



1

<b>GEV No.</b>	100870	<b>Ref. No.</b>	RTCU900134
<b>description</b>	olive for pipe $\varnothing$ 4mm Qty 1 pcs suitable for 160 series for pilot burner		
<b>For models:</b>	MG099-03-012, MG099-03-012M, MG099-13-012I, MG099-13-012IM		



1

<b>GEV No.</b>	100898	<b>Ref. No.</b>	RTCU800183
<b>description</b>	olive for pipe $\varnothing$ 6mm Qty 1 pcs for pilot burner		
<b>For models:</b>	MG086-13-014P, MG117-03-110XL		

<b>accessories for</b>	100898	<b>GEV No.</b>	100909	<b>Ref. No.</b>	RTCP800038 RTCU900019
------------------------	--------	----------------	--------	-----------------	--------------------------

union screw thread M10x1 for pipe  $\varnothing$  6mm Qty 1 pcs

<b>GEV No.</b>	101286	<b>Ref. No.</b>	RTCU900018
<b>description</b>	olive ID $\varnothing$ 6mm Qty 1 pcs		
<b>For models:</b>	MG077-03-003, MG077-03-004, MG077-03-005, MG077-13-003, MG077-13-004, MG077-13-005, MG117-03-110XL		

<b>accessories for</b>	101286	<b>GEV No.</b>	100909	<b>Ref. No.</b>	RTCP800038 RTCU900019
------------------------	--------	----------------	--------	-----------------	--------------------------

union screw thread M10x1 for pipe  $\varnothing$  6mm Qty 1 pcs

<b>GEV No.</b>	101464	<b>Ref. No.</b>	—
----------------	--------	-----------------	---

union nut thread M12x1 for pipe  $\varnothing$  6mm

1

<b>GEV No.</b>	106799	<b>Ref. No.</b>	RTBF800137
<b>description</b>	olive L 6.5mm brass Qty 1 pcs ID $\varnothing$ 14.3mm ED $\varnothing$ 16.5mm		
<b>For models:</b>	MG099-03-012, MG099-03-012M, MG099-13-012I, MG099-13-012IM		

## union nuts



1

<b>GEV No.</b>	102960	<b>Ref. No.</b>	RTBF800015
<b>description</b>	union nut thread 1/2" WS 24 brass for pipe $\varnothing$ 14mm		
<b>For models:</b>	MG099-03-012, MG099-03-012M, MG099-13-012I, MG099-13-012IM		

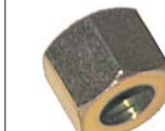

1

<b>GEV No.</b>	101478	<b>Ref. No.</b>	RTCU900013
<b>description</b>	union nut thread 3/8" for pipe $\varnothing$ 10mm		
<b>For models:</b>	MG046-03-003, MG046-03-004, MG066-03-007, MG066-03-008, MG077-03-003, MG077-03-004, MG077-03-005, MG077-13-003, MG077-13-004, MG077-13-005		



1

<b>GEV No.</b>	101300	<b>Ref. No.</b>	RTCU700297
<b>description</b>	union nut thread M16x1.5 tube $\varnothing$ 10mm		
<b>For models:</b>	MG066-03-008, MG077-03-003, MG077-03-004, MG077-03-005, MG077-13-003, MG077-13-004, MG077-13-005, MG117-03-110XL		

<b>accessories for</b>	101300	<b>GEV No.</b>	101278	<b>Ref. No.</b>	RTCU900012
------------------------	--------	----------------	--------	-----------------	------------

olive for pipe  $\varnothing$  10mm Qty 1 pcs







Зип Общежит  
consumables

vsezip.ru

+7(812)987-08-81

union screws

			
1			
<b>GEV No.</b>	100908	<b>Ref. No.</b>	RTCU900133
<b>description</b>	union screw thread M10x1 for pipe ø 4mm Qty 1 pcs		
<b>For models:</b>	MG099-03-012, MG099-03-012M, MG099-13-012I, MG099-13-012IM		
<b>accessories for</b>	100908		
	<b>GEV No.</b>	100897	<b>Ref. No.</b> —
olive for pipe ø 4mm Qty 1 pcs for pilot burner			
	<b>GEV No.</b>	101246	<b>Ref. No.</b> —
olive for pipe ø 4mm Qty 1 pcs			
	<b>GEV No.</b>	101280	<b>Ref. No.</b> —
olive for pipe ø 4mm Qty 1 pcs			
	<b>GEV No.</b>	101282	<b>Ref. No.</b> —
olive for pipe ø 4mm L 7.4mm Qty 1 pcs			

			
1			
<b>GEV No.</b>	100909	<b>Ref. No.</b>	RTCP800038 RTCU900019
<b>description</b>	union screw thread M10x1 for pipe ø 6mm Qty 1 pcs		
<b>For models:</b>	MG077-03-003, MG077-03-004, MG077-03-005, MG077-13-003, MG077-13-004, MG077-13-005, MG099-03-012, MG099-03-012M, MG099-13-012I, MG099-13-012IM, MG117-03-110XL		
<b>accessories for</b>	100909		
	<b>GEV No.</b>	100898	<b>Ref. No.</b> RTCU800183
olive for pipe ø 6mm Qty 1 pcs for pilot burner			
	<b>GEV No.</b>	101286	<b>Ref. No.</b> RTCU900018
olive ID ø 6mm Qty 1 pcs			
	<b>GEV No.</b>	101287	<b>Ref. No.</b> —
olive for pipe ø 6mm Qty 1 pcs			
	<b>GEV No.</b>	101288	<b>Ref. No.</b> —
olive for pipe ø 6mm L 6mm aluminium Qty 1 pcs ED ø 8.5mm			

			
1			
<b>GEV No.</b>	211001	<b>Ref. No.</b>	A800001170
<b>description</b>	lava rocks Qty package content 9kg		
<b>For models:</b>	MG086-13-014P		

equipment-specific units

for ice-cube maker

			
1			
<b>GEV No.</b>	694669	<b>Ref. No.</b>	2LV017
<b>description</b>	spray arm L 330mm nozzles 8		
<b>For models:</b>	KL030-10-000A, KL030-10-000W		

for espresso machines

			
1			
<b>GEV No.</b>	510893	<b>Ref. No.</b>	456015
<b>description</b>	O-ring EPDM thickness 2.62mm ID ø 9.92mm Qty 1 pcs		
<b>For models:</b>	D500LS, D501LS		

pipes  
union nuts

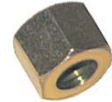
			
1			
<b>GEV No.</b>	101478	<b>Ref. No.</b>	RTCU900013
<b>description</b>	union nut thread 3/8" for pipe ø 10mm		
<b>For models:</b>	MG046-03-003, MG046-03-004, MG066-03-007, MG066-03-008, MG077-03-003, MG077-03-004, MG077-03-005, MG077-13-003, MG077-13-004, MG077-13-005		

## for coffee grinders



1

<b>GEV No.</b>	345742	<b>Ref. No.</b>	RTBF900277
<b>description</b>	microswitch with lever 250V 16A 1CO connection male faston 6.3mm L 55mm ambient temperature max. 120°C mounting distance 22mm actuating force: 75g lever length 46mm		
<b>For models:</b>	ME046-03-004, ME066-03-007		

## for tilting bratt pans

## gearboxes



1

<b>GEV No.</b>	693642	<b>Ref. No.</b>	RTBF900109
<b>description</b>	gearbox motor shaft $\varnothing$ 19mm flange $\varnothing$ 118mm transmission I=1/60 drive shaft $\varnothing$ 30mm flange $\varnothing$ 180mm fixing dimensions 105mm type VU-70		
<b>For models:</b>	MG099-03-012, MG099-03-012M, MG099-13-012I, MG099-13-012IM		

## for sliding doors

## stand-offs



1

<b>GEV No.</b>	690468	<b>Ref. No.</b>	011359-00-R
<b>description</b>	distance washer		

## Зип-Общепит

for dishwashers

containers

vsezip.ru

salt tanks

+7(812)987-08-81



1

<b>GEV No.</b>	524177	<b>Ref. No.</b>	480005
<b>description</b>	lid $\varnothing$ 69mm H 20mm for salt tank ID $\varnothing$ 50mm		
<b>For models:</b>	D500LS, D501LS		
<b>accessories for</b>	524177		
	<b>GEV No.</b>	524148	<b>Ref. No.</b>
			—
	O-ring EPDM thickness 3.53mm ID $\varnothing$ 40.86mm Qty 1 pcs		



1

<b>GEV No.</b>	510018	<b>Ref. No.</b>	429011
<b>description</b>	nut $\varnothing$ 92mm H 10.5mm for salt tank ID $\varnothing$ 64mm		
<b>For models:</b>	D500LS, D501LS		



1





<b>GEV No.</b>	510032	<b>Ref. No.</b>	406998
<b>description</b>	salt tank without gasket new model		
<b>For models:</b>	D500LS, D501LS		
<b>spare parts for</b>	510032		
	<b>GEV No.</b>	506015	<b>Ref. No.</b>
			456052
	O-ring EPDM thickness 3.53mm ID $\varnothing$ 39.69mm Qty 1 pcs		
	<b>GEV No.</b>	510018	<b>Ref. No.</b>
			429011
	nut $\varnothing$ 92mm H 10.5mm for salt tank ID $\varnothing$ 64mm		
	<b>GEV No.</b>	510071	<b>Ref. No.</b>
			437034
	flat gasket rubber ED $\varnothing$ 81mm ID $\varnothing$ 68mm thickness 3mm for salt tank Qty 1 pcs		

Table continues overleaf







spare parts for 510032			
	GEV No.	524177	Ref. No. 480005
lid ø 69mm H 20mm for salt tank ID ø 50mm			

accessories			
			
1			
GEV No.	510071	Ref. No.	437034
description	flat gasket rubber ED ø 81mm ID ø 68mm thickness 3mm for salt tank Qty 1 pcs		
For models:	D500LS, D501LS		

boilers			
boilers for dishwashers			
			
1			
GEV No.	518235	Ref. No.	104060
description	boiler ø 145mm L 405mm flange 3 hole flange		
For models:	D500LS, D501LS		

softener cartridges			
softening columns			
			
1			
GEV No.	530395	Ref. No.	117007
description	softener 4-fold L 380mm W 180mm		
For models:	D500LS, D501LS		

spare parts and accessories			
			
1			
GEV No.	692041	Ref. No.	023415-00
description	mounting clip		

Зип Общепит





vsezip.ru

+7(812)987-08-81

housing and bezels			
miscellaneous			
			
1			
GEV No.	513000	Ref. No.	480057
description	lid rubber ED ø 27mm		
For models:	D500LS, D501LS		

			
1			
GEV No.	513708	Ref. No.	480058
description	lid rubber ø 17mm mounting ø 17mm		
For models:	D500LS, D501LS		

air traps			
air traps			
			
1			
GEV No.	518488	Ref. No.	107005
description	air trap		
For models:	D500LS, D501LS		
accessories for	518488		
	GEV No.	504618	Ref. No. —
O-ring EPDM thickness 2.62mm ID ø 15.54mm Qty 1 pcs			
	GEV No.	510075	Ref. No. 437019
flat gasket rubber ED ø 22mm ID ø 13mm thickness 1.5mm Qty 1 pcs			
	GEV No.	510106	Ref. No. 468029
hose connector for air trap			

			
1			
GEV No.	518200	Ref. No.	984005
description	air trap ø 34mm H 78mm hose ø 6mm plastic		
For models:	D500LS, D501LS		
spare parts for	518200		
	GEV No.	504618	Ref. No. —
O-ring EPDM thickness 2.62mm ID ø 15.54mm Qty 1 pcs			
	GEV No.	510075	Ref. No. 437019
flat gasket rubber ED ø 22mm ID ø 13mm thickness 1.5mm Qty 1 pcs			
	GEV No.	510106	Ref. No. 468029
hose connector for air trap			

## air trap accessories



1

<b>GEV No.</b>	510075	<b>Ref. No.</b>	437019
<b>description</b>	flat gasket rubber ED ø 22mm ID ø 13mm thickness 1.5mm Qty: 1 pcs		
<b>For models:</b>	D500LS, D501LS		



1

<b>GEV No.</b>	510106	<b>Ref. No.</b>	468029
<b>description</b>	hose connector for air trap		
<b>For models:</b>	D500LS, D501LS		

## pulleys



1

<b>GEV No.</b>	693828	<b>Ref. No.</b>	RTBF900124
<b>description</b>	round belt pulley disc ø 212mm single shaft intake ø 19mm groove depth 11mm disc width 16mm groove width 10mm overall width 26mm shaft ø 48mm		
<b>For models:</b>	MG099-03-012, MG099-13-012I		

## backflow preventers

## backflow preventers



1

<b>GEV No.</b>	518297	<b>Ref. No.</b>	144011
<b>description</b>	backflow preventer		
<b>For models:</b>	D500LS, D501LS		

## door mechanics

## linkage



1

<b>GEV No.</b>	518355	<b>Ref. No.</b>	304021
<b>description</b>	door pin step rod		
<b>For models:</b>	D500LS, D501LS		

## sliding plates



1

<b>GEV No.</b>	518356	<b>Ref. No.</b>	307003
<b>description</b>	sliding plate sliding plate		
<b>For models:</b>	D500LS, D501LS		

## hinges



1

<b>GEV No.</b>	518301	<b>Ref. No.</b>	311019
<b>description</b>	door hinge mounting pos. left/right		
<b>For models:</b>	D500LS, D501LS		

## hinge pins



1

<b>GEV No.</b>	518267	<b>Ref. No.</b>	325036
<b>description</b>	hinge pin hinge pin		
<b>For models:</b>	D500LS, D501LS		

## door bumpers



1

<b>GEV No.</b>	518066	<b>Ref. No.</b>	417041
<b>description</b>	door bumper end stop		
<b>For models:</b>	D500LS, D501LS		

Зип.Общепит

vsezip.ru

+7(812)987-08-81

Зип Общепит

vsezip.ru

+7(812)987-08-81

locks



1

<b>GEV No.</b>	513138	<b>Ref. No.</b>	994012
<b>description</b>	door catch with nut door locking catch		
<b>For models:</b>	D500LS, D501LS		



1

<b>GEV No.</b>	518298	<b>Ref. No.</b>	325066
<b>description</b>	spigot door catch		
<b>For models:</b>	D500LS, D501LS		

washing and rinsing systems



1

<b>GEV No.</b>	518461	<b>Ref. No.</b>	303029
<b>description</b>	flange for wash arm support		
<b>For models:</b>	D500LS, D501LS		



1

<b>GEV No.</b>	517444	<b>Ref. No.</b>	80697
<b>description</b>	knurled nut thread M10x1 ø 25mm H 4mm SS		
<b>For models:</b>	D500LS, D501LS		



1

<b>GEV No.</b>	517454	<b>Ref. No.</b>	308031
<b>description</b>	nut for wash arm ED ø 35mm thickness 11mm plastic		
<b>For models:</b>	D500LS, D501LS		



1

<b>GEV No.</b>	518125	<b>Ref. No.</b>	143240
<b>description</b>	rinse hose ø 17.5mm		
<b>For models:</b>	D500LS, D501LS		



1

<b>GEV No.</b>	518003	<b>Ref. No.</b>	447128
<b>description</b>	screw cap		
<b>For models:</b>	D500LS, D501LS		



1

<b>GEV No.</b>	517443	<b>Ref. No.</b>	80623
<b>description</b>	slide ring for rinse arm mounting pos. upper/lower PTFE ED ø 22mm ID ø 9.5mm thickness 1mm		
<b>For models:</b>	D500LS, D501LS		



1

<b>GEV No.</b>	510112	<b>Ref. No.</b>	454002
<b>description</b>	Thumb screw thread M10 thread L 10mm ø 22mm H 4.5mm SS		
<b>For models:</b>	D500LS, D501LS		

knobs

universal knobs



1

<b>GEV No.</b>	110253	<b>Ref. No.</b>	8335612010-R
<b>description</b>	knob switch zero mark t.max.°C ø 50mm shaft ø 6x4.6mm shaft flat upper black		

producer-specific knobs

DEXION



1

<b>GEV No.</b>	110861	<b>Ref. No.</b>	020778-00 020778-00R 8335602010-R
<b>description</b>	knob thermostat t.max. 110°C 30-110°C ø 49mm shaft ø 6x4.6mm shaft flat upper black temperature range 30-110°C		

Зип-Общепит

cone handles

miscellaneous



1			
<b>GEV No.</b>	112068	<b>Ref. No.</b>	168846
<b>description</b>	knob hot water ø 70mm shaft ø 10x8mm shaft flat upper		
<b>For models:</b>	LX7EC4		



1			
<b>GEV No.</b>	698790	<b>Ref. No.</b>	25007038
<b>description</b>	knob ø 44mm shaft ø 5x7mm shaft flat right and left black Qty 1 pcs		

accessories

gaskets



1			
<b>GEV No.</b>	112078	<b>Ref. No.</b>	RTCU800185
<b>description</b>	gasket knob		
<b>For models:</b>	ME066-03-010, ME066-03-013, ME103-03-013XL, ME106-03-010XL, ME106-03-013		

handles and hand wheels

hand wheels

hand wheels



1			
<b>GEV No.</b>	690555	<b>Ref. No.</b>	RTBF800093
<b>description</b>	hand wheel ø 200mm D1 ø 50mm bore ø 20mm thread M6 hole distance 7mm groove width 6mm L1 40mm L2 43mm handle length 85mm with folding handle		
<b>For models:</b>	MG099-03-012M, MG099-13-012IM		



1			
<b>GEV No.</b>	110704	<b>Ref. No.</b>	RTCU700413
<b>description</b>	cone handle thread M6 ø 16mm L 25mm plastic black		
<b>For models:</b>	ME046-03-003, ME046-03-004, ME066-03-006, ME066-03-007, ME066-03-008, MG046-03-003, MG046-03-004, MG066-03-006, MG066-03-007, MG066-03-008		

bracket handles



1			
<b>GEV No.</b>	693810	<b>Ref. No.</b>	9636273200 RICO002479
<b>description</b>	pull handle		
<b>For models:</b>	ME066-03-010, ME066-03-013, ME103-03-013XL, ME106-03-010XL, ME106-03-013, MG066-03-010, MG106-03-010, MG106-03-010XL		

lever handles



1			
<b>GEV No.</b>	540871	<b>Ref. No.</b>	RTCU900492
<b>description</b>	lever handle cold water suitable for intake tap		
<b>For models:</b>	ME066-03-008, MG066-03-008		

locks

locking devices

producer-specific

DEXION



1			
<b>GEV No.</b>	690462	<b>Ref. No.</b>	01349400R
<b>description</b>	key cylinder ø 23mm thread M19x1 mounting measurements 16.5x19mm hub 38-45mm shaft ø 11mm thread L 12mm		
<b>spare parts for</b>	690462		
	<b>GEV No.</b>	691589	<b>Ref. No.</b>
			—
	spare keys for key cylinder 690462 key number 9233		





Зип Общежит  
walk-in fridge catches

INTERKLIMAT  
1800 series

+7(812)987-08-81

1

<b>GEV No.</b>	690461	<b>Ref. No.</b>	01348600R
<b>description</b>	key cylinder straight thread M19x1 rotation 90° cam length 5 mm cam width 16mm		

edgemoount latches

handle latches

CAFF/FERMOD

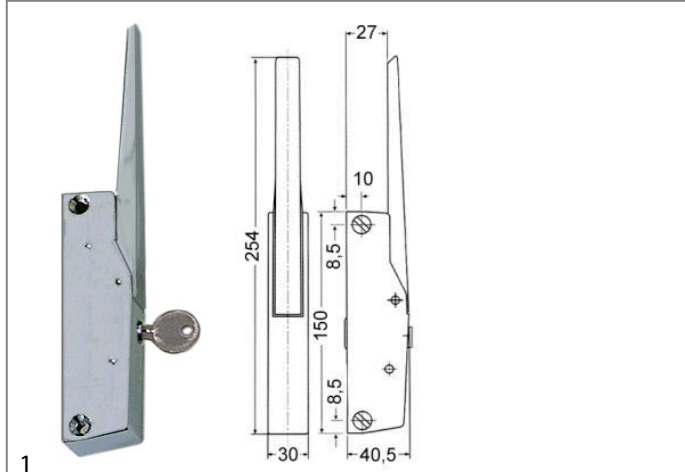

1

<b>GEV No.</b>	690413	<b>Ref. No.</b>	795CRR	
<b>description</b>	handle latch L 150mm mounting distance 133mm lockable refrigeration units G 795			
<b>accessories for</b>	690413			
	<b>GEV No.</b>	690418	<b>Ref. No.</b>	—
	door catch L 36mm W 19mm H 29mm mounting distance 12mm zinc-coated steel for refrigeration units			
	<b>GEV No.</b>	690419	<b>Ref. No.</b>	—
	door catch L 52mm W 20mm H 30mm mounting distance 26-37mm zamak for refrigeration units			
	<b>GEV No.</b>	700435	<b>Ref. No.</b>	—
	door catch L 58mm W 20mm H 35mm mounting distance 42mm zamak for refrigeration units			

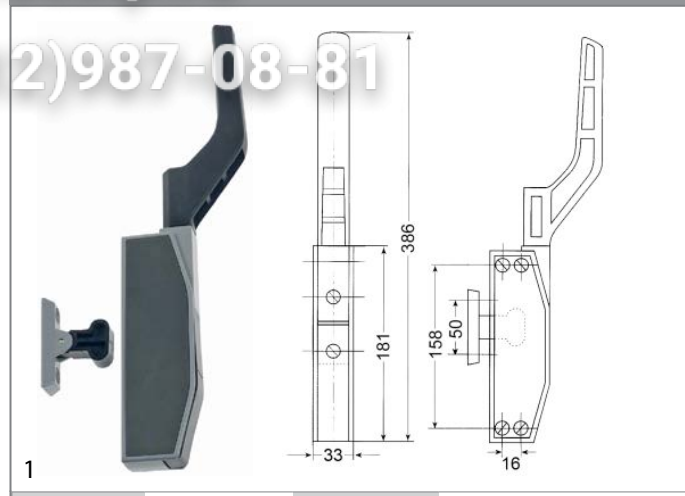

1

<b>GEV No.</b>	690457	<b>Ref. No.</b>	1825R
<b>description</b>	handle latch mounting distance 158mm L 181mm refrigeration units external lock type 1825 suitable for 1850		

hingess  
edgemoount hingess

CAFF/FERMOD

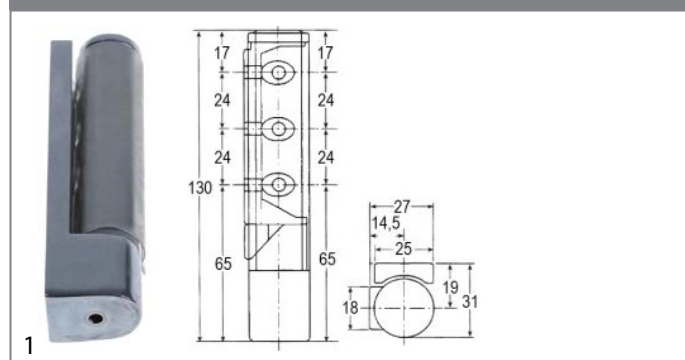

1

<b>GEV No.</b>	690436	<b>Ref. No.</b>	430CRR	
<b>description</b>	edgemoount hinge L 130mm W 27mm mounting distance 48mm hinging left/right with gradient chrome-plated refrigeration units series G 430 centre of rotation 19mm			
<b>accessories for</b>	690436			
	<b>GEV No.</b>	690395	<b>Ref. No.</b>	—
	base plate for type 300/303 thickness 5mm L 100mm			

Зип Общежит  
spring assisted hinges

universal  
vsezip.ru  
INTERKLIMAT

hinges  
+7(812)987-08-81

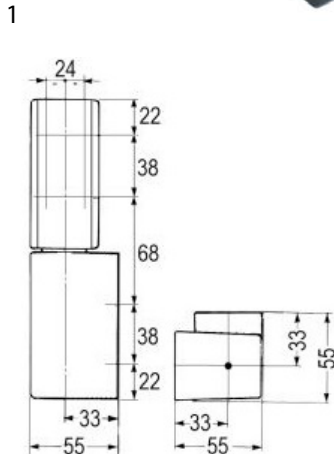
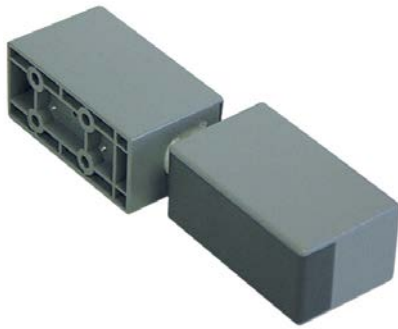

<b>GEV No.</b>	690458	<b>Ref. No.</b>	910R
<b>description</b>	edgmount hinge L 188mm mounting distance 38mm hinging left/right with gradient series G 915		
<b>accessories for</b>	690458		
	<b>GEV No.</b>	691642	<b>Ref. No.</b> —
	base plate thickness 5mm plastic L 98mm W 49mm		

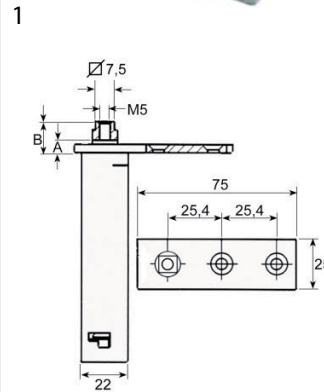

<b>GEV No.</b>	690714	<b>Ref. No.</b>	022104-00
<b>description</b>	spring assisted hinge series 28XC mounting pos. left/right L 75mm W 25mm H 103mm A 8mm B 11mm intake 7.5x7.5 refrigeration units mounting distance 25mm		

oven hinges

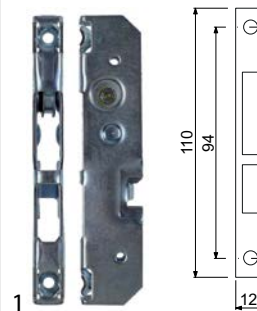

<b>GEV No.</b>	700003	<b>Ref. No.</b>	9626105200 RIC0002448
<b>description</b>	opposite support L 110mm W 12mm mounting distance 94mm		
<b>For models:</b>	ME066-03-010, ME066-03-013, ME106-03-013, MG066-03-010		



Зип Общепит

vsezip.ru

+7(812)987-08-81

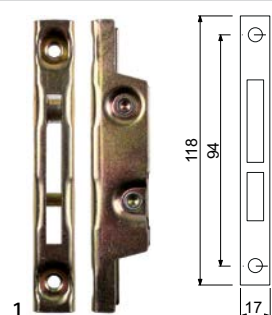

1

<b>GEV No.</b>	700001	<b>Ref. No.</b>	RTC900004
<b>description</b>	opposite support L 118mm W 17mm mounting distance 94mm		
<b>For models:</b>	MG117-03-110XL		



1

<b>GEV No.</b>	700396	<b>Ref. No.</b>	9626107200
<b>description</b>	opposite support oven hinge		
<b>For models:</b>	ME103-03-013XL, ME106-03-010XL, MG106-03-010, MG106-03-010XL		



1

<b>GEV No.</b>	690498	<b>Ref. No.</b>	9626107000	
<b>description</b>	oven hinge mounting distance 118mm lug mounting 13mm lever length 119mm groove distance 12mm spring thickness 4mm mounting ear position right spring length 59mm L 155mm W 21mm			
<b>For models:</b>	ME103-03-013XL, ME106-03-010XL, MG106-03-010, MG106-03-010XL			
<b>accessories for</b>	690498			
	<b>GEV No.</b>	700003	<b>Ref. No.</b>	9626105200 RIC0002448
opposite support L 110mm W 12mm mounting distance 94mm				

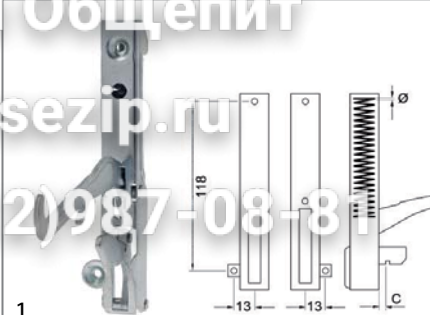

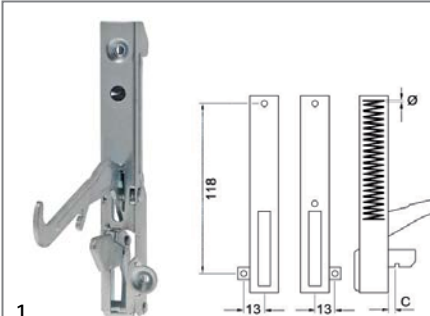

1

<b>GEV No.</b>	700013	<b>Ref. No.</b>	9626105100 RIC0002134	
<b>description</b>	oven hinge mounting distance 118mm lug mounting 13mm lever length 119mm groove distance 13mm spring thickness 3.5mm mounting ear position left spring length 60mm L 154mm			
<b>For models:</b>	ME066-03-010, ME066-03-013, ME106-03-013, MG066-03-010			
<b>accessories for</b>	700013			
	<b>GEV No.</b>	700003	<b>Ref. No.</b>	9626105200 RIC0002448
opposite support L 110mm W 12mm mounting distance 94mm				



1

<b>GEV No.</b>	700014	<b>Ref. No.</b>	9626105000 RIC0002133	
<b>description</b>	oven hinge mounting distance 118mm mounting distance 2mm lug mounting 13mm lever length 119mm groove distance 13mm spring thickness 3.5mm mounting ear position right spring length 60mm L 154mm			
<b>For models:</b>	ME066-03-010, ME066-03-013, ME106-03-013, MG066-03-010			
<b>accessories for</b>	700014			
	<b>GEV No.</b>	700003	<b>Ref. No.</b>	9626105200 RIC0002448
opposite support L 110mm W 12mm mounting distance 94mm				



1

<b>GEV No.</b>	694505	<b>Ref. No.</b>	9626107100
<b>description</b>	oven hinge mounting distance 118mm mounting distance 2mm lug mounting 13mm lever length 125mm groove distance 12mm spring thickness 4mm mounting ear position left spring length 59mm L 155mm W 21mm with hook		
<b>For models:</b>	ME103-03-013XL, ME106-03-010XL, MG106-03-010, MG106-03-010XL		

Зип Общепит

vsezip.ru

+7(812)987-08-81

<b>GEV No.</b>	700007	<b>Ref. No.</b>	RTCU900396
<b>description</b>	oven hinge mounting distance 173mm mounting distance 2 105mm lug mounting 14mm lever length 120mm groove distance 11mm spring thickness 3.5mm mounting ear position right spring length 112mm W 25mm		
<b>For models:</b>	MG117-03-110XL		
<b>accessories for</b>	700007		
	<b>GEV No.</b>	700001	<b>Ref. No.</b> RTCU900004
	opposite support L 118mm W 17mm mounting distance 94mm		

<b>GEV No.</b>	690986	<b>Ref. No.</b>	162198
<b>description</b>	hinge bearing mounting pos. upper left with bolt		
<b>For models:</b>	LX7EC4		

door bearing

<b>GEV No.</b>	690464	<b>Ref. No.</b>	01156100R
<b>description</b>	hinge bearing mounting pos. bottom left/upper right with bolt		

<b>GEV No.</b>	690463	<b>Ref. No.</b>	01156300R
<b>description</b>	hinge bearing mounting pos. upper left/bottom right with bolt		

<b>GEV No.</b>	690984	<b>Ref. No.</b>	RTCP800028
<b>description</b>	hinge bearing mounting pos. left without bolt		
<b>For models:</b>	MG099-03-012, MG099-03-012M, MG099-13-012I, MG099-13-012IM		

<b>GEV No.</b>	690985	<b>Ref. No.</b>	162199
<b>description</b>	hinge bearing mounting pos. upper right		
<b>For models:</b>	LX7EC4		

<b>GEV No.</b>	690983	<b>Ref. No.</b>	RTCP800030
<b>description</b>	hinge bearing mounting pos. right without bolt		
<b>For models:</b>	MG099-03-012, MG099-03-012M, MG099-13-012I, MG099-13-012IM		

<b>GEV No.</b>	690465	<b>Ref. No.</b>	01157600R
<b>description</b>	hinge bearing with bolt		

accessories

miscellaneous

<b>GEV No.</b>	693826	<b>Ref. No.</b>	RTCP800027
<b>description</b>	spring guide for hinge		
<b>For models:</b>	MG099-03-012, MG099-03-012M, MG099-13-012I, MG099-13-012IM		

pullouts

drawer slides

producer-specific

<b>GEV No.</b>	690721	<b>Ref. No.</b>	01513600R
<b>description</b>	drawer slide L 490mm pull-out length 410mm Qty 1 pair W 20mm H 33mm mounting pos. right/left for refrigerated counters 600mm		





Зип Общепит fittings for catering equipment

vsezip.ru

+7(812)987-08-81

1			
<b>GEV No.</b>	690722	<b>Ref. No.</b>	01468200R
<b>description</b>	drawer slide L 590mm pull-out length 570mm Qty 1 pair W 17mm H 62mm mounting pos. right/left for refrigerated counter 700mm		
<b>spare parts for</b>	690722		
	<b>GEV No.</b>	690750	<b>Ref. No.</b>
	stop for telescopic rail L 20mm plastic H 12mm D 9mm		

rollers

rollers

1			
<b>GEV No.</b>	690466	<b>Ref. No.</b>	01000600R
<b>description</b>	roller rollerø 25mm B1 6mm overall width 10mm A 25mm B 6mm C 10mm D 6mm E 10mm plastic bearing ball bearing		

1			
<b>GEV No.</b>	690467	<b>Ref. No.</b>	01000801R 010412-00
<b>description</b>	roller rollerø 28mm B1 6mm overall width 14mm A 28mm B 6mm C 9.5mm D 5.8mm E 12mm plastic bearing ball bearing		

roller with holder

1			
<b>GEV No.</b>	690955	<b>Ref. No.</b>	2330706
<b>description</b>	roller rollerø 28mm B1 6mm with holder SS/Nylon mounting pos. upper bearing slide bearing Qty 1 pcs H 5mm L 62mm mounting distance 25/45mm		

outlet taps

1			
<b>GEV No.</b>	540862	<b>Ref. No.</b>	RTCU600422
<b>description</b>	lever for outlet tap thread M6 ET - M6 ET		
<b>For models:</b>	ME046-03-003, ME046-03-004, ME066-03-006, ME066-03-007, MG046-03-003, MG046-03-004, MG066-03-006, MG066-03-007		

1			
<b>GEV No.</b>	540864	<b>Ref. No.</b>	RTCU700412
<b>description</b>	lever for outlet tap thread M6 ET - M6 ET		
<b>For models:</b>	ME066-03-008, MG066-03-008		

lid hinges

1			
<b>GEV No.</b>	700395	<b>Ref. No.</b>	RTBF800080
<b>description</b>	lid hinge		
<b>For models:</b>	MG099-03-012, MG099-03-012M, MG099-13-012I, MG099-13-012IM		

inlet taps

1			
<b>GEV No.</b>	514048	<b>Ref. No.</b>	RTCU600075
<b>description</b>	ball valve connection 1/2" complete total length 55mm mounting pos. any brass H 30mm L 55mm rosette ø 70mm rosette thread G2 M22x1		
<b>For models:</b>	ME066-03-008, MG066-03-008		
<b>spare parts for</b>	514048		
	<b>GEV No.</b>	540871	<b>Ref. No.</b>
	lever handle cold water suitable for intake tap		

filters

device filters

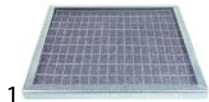

<b>GEV No.</b>	970666	<b>Ref. No.</b>	013524-00-R
<b>description</b>	air filter L 265mm W 252mm H 12mm metal for condenser		

equipment feet and end caps

screw-in feet



<b>GEV No.</b>	513284	<b>Ref. No.</b>	461019
<b>description</b>	equipment foot thread M8 thread L 20mm ø 30mm H 12mm Qty 1 pcs		
<b>For models:</b>	D500LS, D501LS		

shelves and shelf rails

grates

universal

without upstand



<b>GEV No.</b>	970125	<b>Ref. No.</b>	OA000-00-023
<b>description</b>	grate W 325mm D 530mm GN 1/1 plastic-coated steel crossing wires 1 white suitable for refrigerator		
<b>accessories for</b>	970125		
	<b>GEV No.</b>	690330	<b>Ref. No.</b> —
	rack L 1000mm W 22mm H 4mm aperture 3x8mm hole distance 12.5mm stainless steel		
	<b>GEV No.</b>	694700	<b>Ref. No.</b> —
	shelf support L 31/28mm W 22mm H 18mm SS Qty 12 pcs		
	<b>GEV No.</b>	694701	<b>Ref. No.</b> —
	shelf support L 31/28mm W 22mm H 17mm SS with hook Qty 12 pcs		

Зип Общепит

vsezip.ru

+7(812)987-08-81



<b>GEV No.</b>	970557	<b>Ref. No.</b>	OA000-00-021
<b>description</b>	grate W 555mm D 670mm plastic-coated steel with hinge camp crossing wires 2 suitable for refrigerator		
<b>accessories for</b>	970557		
	<b>GEV No.</b>	690330	<b>Ref. No.</b> —
	rack L 1000mm W 22mm H 4mm aperture 3x8mm hole distance 12.5mm stainless steel		
	<b>GEV No.</b>	694700	<b>Ref. No.</b> —
	shelf support L 31/28mm W 22mm H 18mm SS Qty 12 pcs		
	<b>GEV No.</b>	694701	<b>Ref. No.</b> —
	shelf support L 31/28mm W 22mm H 17mm SS with hook Qty 12 pcs		

shelf rails and supports

producer-specific



<b>GEV No.</b>	692243	<b>Ref. No.</b>	010912-02
<b>description</b>	guide L 580mm W 16mm high 19mm mounting measurements 552mm mounting pos. left		



<b>GEV No.</b>	692244	<b>Ref. No.</b>	010911-02
<b>description</b>	guide L 580mm W 16mm inner high 19mm mounting measurements 552mm mounting pos. right		



<b>GEV No.</b>	690734	<b>Ref. No.</b>	OA00000800
<b>description</b>	pair of setting bar L-shape L 780mm W 40mm H 24mm		



Зип Общепит

vsezip.ru

+7(812)987-08-81



<b>GEV No.</b>	695088	<b>Ref. No.</b>	OA000-SK-033
<b>description</b>	pair of setting bar U-shape L 570mm W 19mm inner height 20mm suitable for new Skin-Series		

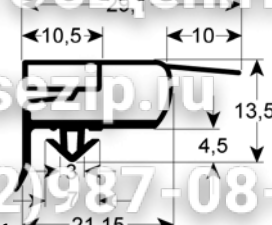

<b>GEV No.</b>	900334	<b>Ref. No.</b>	01153700R RIC0002904
<b>description</b>	refrigeration gasket profile 9773 W 690mm L 745mm external size W1 677mm L1 732mm plug size		

**gaskets**

**refrigeration gaskets**

**miscellaneous**



<b>GEV No.</b>	900613	<b>Ref. No.</b>	01783000R
<b>description</b>	bottom gasket L 780mm		



<b>GEV No.</b>	900365	<b>Ref. No.</b>	01746900R
<b>description</b>	bottom gasket L 810mm		

**plug-in gaskets**

**profile 9773**

We offer custom-made gaskets for this profile

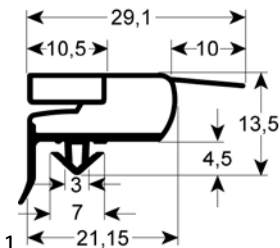

<b>GEV No.</b>	900603	<b>Ref. No.</b>	011536-00Gu
<b>description</b>	refrigeration gasket profile 9773 W 675mm L 740mm plug size		

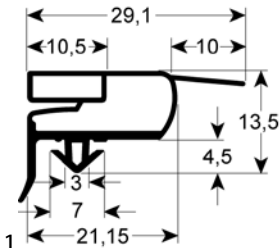

<b>GEV No.</b>	900335	<b>Ref. No.</b>	011535-00 01153500R RIC0002903
<b>description</b>	refrigeration gasket profile 9773 W 690mm L 1550mm external size W1 677mm L1 1537mm plug size		

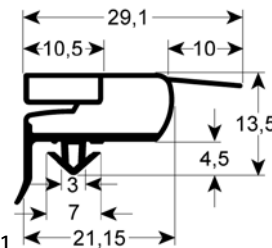

<b>GEV No.</b>	902305	<b>Ref. No.</b>	N/A
<b>description</b>	refrigeration gasket profile 9773 Wmm L 2500mm		

**profile 9704**

We offer custom-made gaskets for this profile

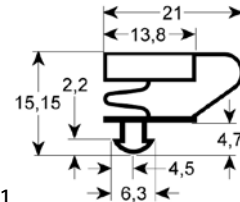

<b>GEV No.</b>	902299	<b>Ref. No.</b>	N/A
<b>description</b>	refrigeration gasket profile 9704 Wmm L 2500mm		

**profile 9333**

We offer custom-made gaskets for this profile

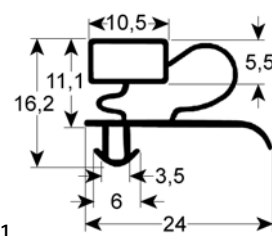

<b>GEV No.</b>	900343	<b>Ref. No.</b>	01746400R
<b>description</b>	refrigeration gasket profile 9333 W 687mm L 1554mm plug size glass door refrigeration		

Зип Общепит

vsezip.ru

+7(812)987-08-81

profile 9990

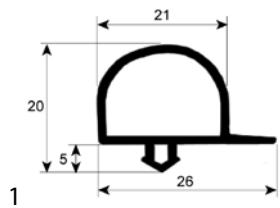

<b>GEV No.</b>	900364	<b>Ref. No.</b>	01746800R
<b>description</b>	refrigeration gasket profile 9990 W 695mm L 1825mm external size short side open		

screw-in gaskets

profile 9663

We offer custom-made gaskets for this profile

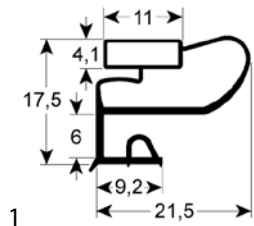

<b>GEV No.</b>	901981	<b>Ref. No.</b>	01710300R
<b>description</b>	refrigeration gasket profile 9663 W 182mm L 424mm external size		

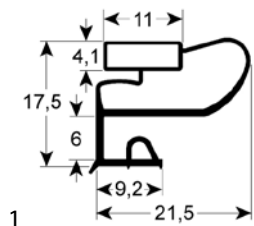

<b>GEV No.</b>	902177	<b>Ref. No.</b>	01710900R
<b>description</b>	refrigeration gasket profile 9663 W 182mm L 629mm external size		

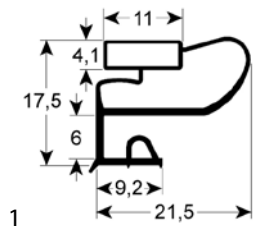

<b>GEV No.</b>	902169	<b>Ref. No.</b>	01236500R 012365-01R
<b>description</b>	refrigeration gasket profile 9663 W 185mm L 390mm external size		

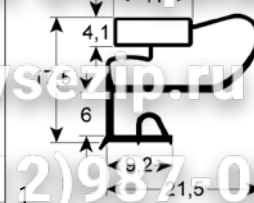

<b>GEV No.</b>	902178	<b>Ref. No.</b>	01711000R
<b>description</b>	refrigeration gasket profile 9663 W 198mm L 629mm external size		

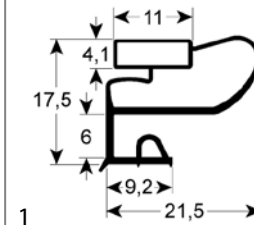

<b>GEV No.</b>	902171	<b>Ref. No.</b>	012361-00 01236100R
<b>description</b>	refrigeration gasket profile 9663 W 205mm L 390mm external size		

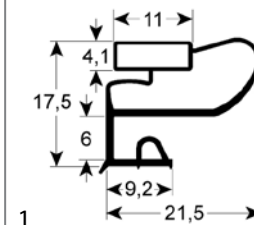

<b>GEV No.</b>	902180	<b>Ref. No.</b>	01346400R
<b>description</b>	refrigeration gasket profile 9663 W 250mm L 420mm external size		

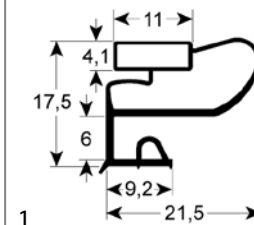

<b>GEV No.</b>	901980	<b>Ref. No.</b>	017102-00 01710200R 025698-00R
<b>description</b>	refrigeration gasket profile 9663 W 302mm L 424mm external size		

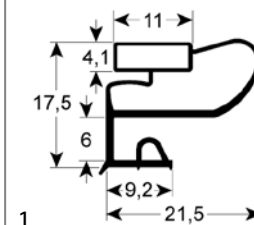

<b>GEV No.</b>	902176	<b>Ref. No.</b>	01710800R 107108-01
<b>description</b>	refrigeration gasket profile 9663 W 302mm L 629mm external size		

Зип Общепит

vsezip.ru

+7(812)987-08-81

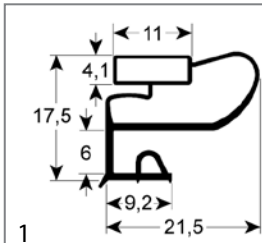

<b>GEV No.</b>	902170	<b>Ref. No.</b>	01236300R 025696-00 025696-00R
<b>description</b>	refrigeration gasket profile 9663 W 310mm L 390mm external size white		



<b>GEV No.</b>	901893	<b>Ref. No.</b>	01288900R
<b>description</b>	refrigeration gasket profile 9663 W 422mm L 538mm external size		

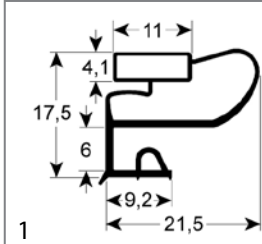

<b>GEV No.</b>	902172	<b>Ref. No.</b>	012362-00 01236200R
<b>description</b>	refrigeration gasket profile 9663 W 390mm L 435mm external size		

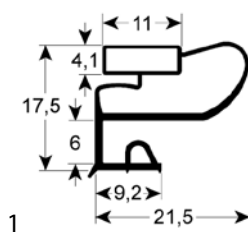

<b>GEV No.</b>	901879	<b>Ref. No.</b>	017104-00 01710400R
<b>description</b>	refrigeration gasket profile 9663 W 424mm L 198mm external size		

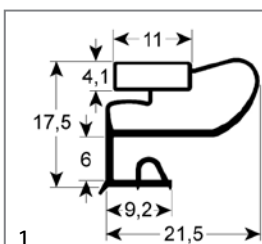

<b>GEV No.</b>	902173	<b>Ref. No.</b>	012364-00 01236400R 025695-00R
<b>description</b>	refrigeration gasket profile 9663 W 390mm L 645mm external size white		

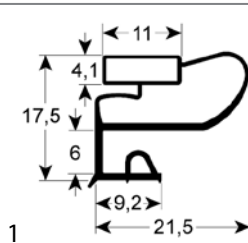

<b>GEV No.</b>	901979	<b>Ref. No.</b>	017101-00 017101-00R
<b>description</b>	refrigeration gasket profile 9663 W 424mm L 630mm external size		

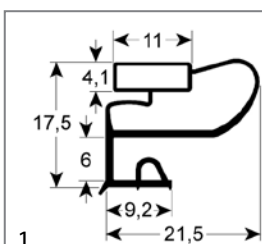

<b>GEV No.</b>	902174	<b>Ref. No.</b>	017105-00 01710500R
<b>description</b>	refrigeration gasket profile 9663 W 420mm L 420mm external size		

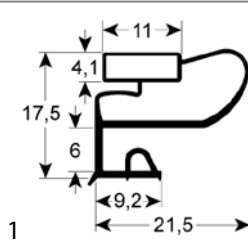

<b>GEV No.</b>	902179	<b>Ref. No.</b>	01710600R
<b>description</b>	refrigeration gasket profile 9663 W 499mm L 630mm external size		

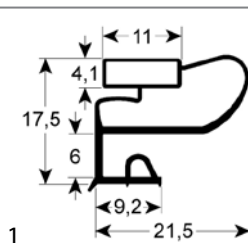

<b>GEV No.</b>	902168	<b>Ref. No.</b>	01288801R
<b>description</b>	refrigeration gasket profile 9663 W 535mm L 675mm external size size 2/1		

Зип.Общепит

vsezip.ru

+7(812)987-0881

door seals with fixing hook



<b>GEV No.</b>	900231 <sup>1</sup>	<b>Ref. No.</b>	9686375000
<b>description</b>	door seal L 590mm W 300mm 3-sided long side open with mounting clip		
<b>For models:</b>	ME103-03-013XL, ME106-03-010XL, MG106-03-010, MG106-03-010XL		

<sup>1</sup>3-sided, long side open

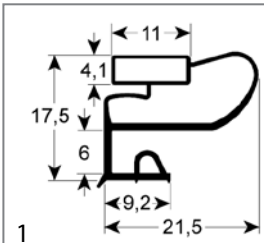

<b>GEV No.</b>	902175	<b>Ref. No.</b>	01710700R
<b>description</b>	refrigeration gasket profile 9663 W 629mm L 630mm external size		

profile 9030

We offer custom-made gaskets for this profile

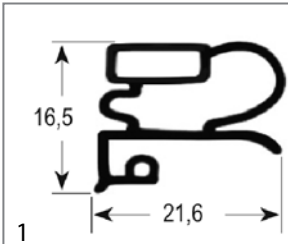

<b>GEV No.</b>	901273	<b>Ref. No.</b>	025699-00R
<b>description</b>	refrigeration gasket profile 9030 W 422mm L 540mm external size		

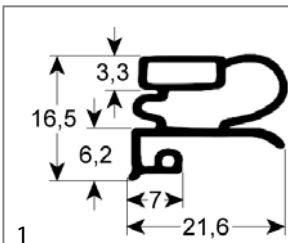

<b>GEV No.</b>	901948	<b>Ref. No.</b>	02569700R
<b>description</b>	refrigeration gasket profile 9030 W 424mm L 630mm external size		

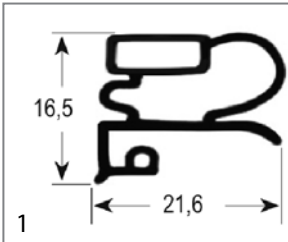

<b>GEV No.</b>	901010	<b>Ref. No.</b>	014052
<b>description</b>	refrigeration gasket profile 9030 W 598mm L 635mm external size		

gaskets for heated units

door seals

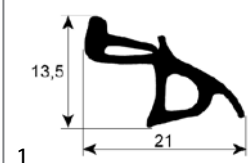

<b>GEV No.</b>	900251	<b>Ref. No.</b>	9686373100 RIC0002340
<b>description</b>	door seal profile 2920 L 1410mm Qty 1		
<b>For models:</b>	ME066-03-010, ME066-03-013, ME106-03-013, MG066-03-010		

door gaskets (wire reinforced)



<b>GEV No.</b>	900300	<b>Ref. No.</b>	9686374100 RIC0002678
<b>description</b>	oven gasket wire reinforced L 430mm W 265mm		
<b>For models:</b>	ME066-03-010, ME066-03-013, ME106-03-013, MG066-03-010		

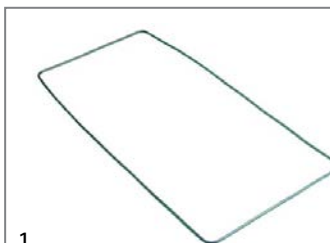

<b>GEV No.</b>	900280	<b>Ref. No.</b>	9686374200
<b>description</b>	oven gasket wire reinforced L 575mm W 265mm		
<b>For models:</b>	ME103-03-013XL, ME106-03-010XL, MG106-03-010, MG106-03-010XL		

O-rings

EPDM

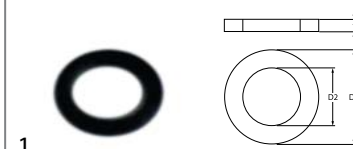

<b>GEV No.</b>	528485	<b>Ref. No.</b>	456060
<b>description</b>	O-ring EPDM thickness 1.78mm ID ø 6.07mm Qty 1 pcs		
<b>For models:</b>	D500LS, D501LS		

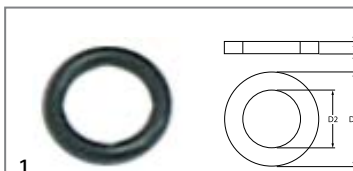

<b>GEV No.</b>	510303	<b>Ref. No.</b>	456030
<b>description</b>	O-ring EPDM thickness 1.78mm ID ø 6.75mm Qty 1 pcs		
<b>For models:</b>	D500LS, D501LS		



Зип Общежит  
Sealing washers

fibre gaskets  
vsezip.ru

+7(812)987-08-81



1

<b>GEV No.</b>	504574	<b>Ref. No.</b>	456019
<b>description</b>	O-ring EPDM thickness 1.78mm ID ø 9.25mm Qty 1 pcs		
<b>For models:</b>	D500LS, D501LS		



1

<b>GEV No.</b>	518227	<b>Ref. No.</b>	456020
<b>description</b>	O-ring EPDM thickness 2.62mm ID ø 12.37mm Qty 1 pcs		
<b>For models:</b>	D500LS, D501LS		

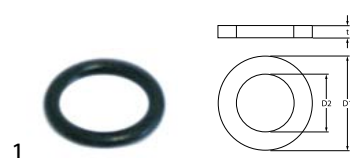

1

<b>GEV No.</b>	510893	<b>Ref. No.</b>	456015
<b>description</b>	O-ring EPDM thickness 2.62mm ID ø 9.92mm Qty 1 pcs		
<b>For models:</b>	D500LS, D501LS		

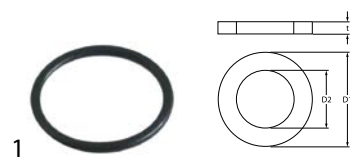

1

<b>GEV No.</b>	506015	<b>Ref. No.</b>	456052
<b>description</b>	O-ring EPDM thickness 3.53mm ID ø 39.69mm Qty 1 pcs		
<b>For models:</b>	D500LS, D501LS		

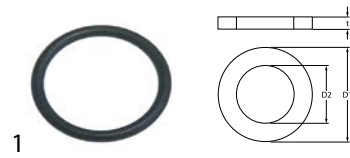

1

<b>GEV No.</b>	510408	<b>Ref. No.</b>	456002 REB456002
<b>description</b>	O-ring EPDM thickness 5.34mm ID ø 47mm Qty 1 pcs		
<b>For models:</b>	D500LS, D501LS, LB03100000, LB03300000, LP05500010		

Viton



1

<b>GEV No.</b>	510243	<b>Ref. No.</b>	RTC700565
<b>description</b>	O-ring Viton thickness 3.53mm ID ø 55.56mm Qty 1 pcs		
<b>For models:</b>	ME046-03-004, ME066-03-007		



1

<b>GEV No.</b>	518541	<b>Ref. No.</b>	REB437021
<b>description</b>	flat gasket FIBER ED ø 12mm ID ø 8mm thickness 1.5mm Qty 1 pcs		
<b>For models:</b>	LP05500010		



1

<b>GEV No.</b>	529349	<b>Ref. No.</b>	437030
<b>description</b>	flat gasket FIBER ED ø 22mm ID ø 16.5mm thickness 2mm for thread 3/8" Qty 1 pcs		
<b>For models:</b>	D500LS, D501LS		

rubber gaskets



1

<b>GEV No.</b>	519547	<b>Ref. No.</b>	437041
<b>description</b>	flat gasket rubber ED ø 14.4mm ID ø 15.5mm thickness 2mm Qty 1 pcs size 3/4"		
<b>For models:</b>	D500LS, D501LS		



1

<b>GEV No.</b>	510075	<b>Ref. No.</b>	437019
<b>description</b>	flat gasket rubber ED ø 22mm ID ø 13mm thickness 1.5mm Qty 1 pcs		
<b>For models:</b>	D500LS, D501LS		



1

<b>GEV No.</b>	513059	<b>Ref. No.</b>	437063
<b>description</b>	flat gasket rubber ED ø 52mm ID ø 40mm thickness 3mm Qty 1 pcs		
<b>For models:</b>	D500LS, D501LS		



1

<b>GEV No.</b>	510071	<b>Ref. No.</b>	437034
<b>description</b>	flat gasket rubber ED ø 81mm ID ø 68mm thickness 3mm for salt tank Qty 1 pcs		
<b>For models:</b>	D500LS, D501LS		

Зип.Общепит refrigeration cycle components

valves expansion valves

DANFOSS valves +7(812)987-08-81

type TN2/TEN2



<b>GEV No.</b>	750012	<b>Ref. No.</b>	01460700R
<b>description</b>	expansion valve DANFOSS type TN2 coolant R134a angled 90° thermostatically controlled inlet 3/8" SAE outlet 1/2" SAE p max 34bar -40 up to +10°C capillary pipe 1500mm		

<b>accessories for</b>	750012		
	<b>GEV No.</b>	<b>Ref. No.</b>	—
nozzle insert size 0X type 068-2002 T/TE 2 DANFOSS			
	<b>GEV No.</b>	<b>Ref. No.</b>	01348500R
nozzle insert size 00 type 068-2003 T/TE 2 DANFOSS			
	<b>GEV No.</b>	<b>Ref. No.</b>	—
nozzle insert size 01 type 068-2010 T/TE 2 DANFOSS			
	<b>GEV No.</b>	<b>Ref. No.</b>	—
nozzle insert size 02 type 068-2015 T/TE 2 DANFOSS			
	<b>GEV No.</b>	<b>Ref. No.</b>	—
nozzle insert size 03 type 068-2006 T/TE 2 DANFOSS			
	<b>GEV No.</b>	<b>Ref. No.</b>	—
nozzle insert size 04 type 068-2007 T2/TE2 DANFOSS			
	<b>GEV No.</b>	<b>Ref. No.</b>	—
nozzle insert size 05 type 068-2008 T2/TE2 DANFOSS			
	<b>GEV No.</b>	<b>Ref. No.</b>	—
nozzle insert size 06 type 068-2009 T2/TE2 DANFOSS			

PTFE gaskets



<b>GEV No.</b>	513725	<b>Ref. No.</b>	437100
<b>description</b>	flat gasket PTFE ED ø 21.2mm ID ø 19mm thickness 0.5mm Qty 1 pcs		
<b>For models:</b>	D500LS, D501LS		

special gaskets

door seals for dishwashers

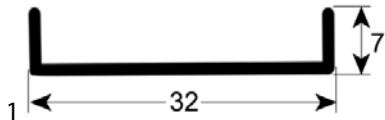

<b>GEV No.</b>	518536	<b>Ref. No.</b>	437081
<b>description</b>	door seal L 590mm W 32mm dishwasher suitable for ELETTROBAR, WOLK equiv. no. 437052		
<b>For models:</b>	D500LS, D501LS		

gaskets for wash arm support



<b>GEV No.</b>	518025	<b>Ref. No.</b>	437014
<b>description</b>	gasket D1 ø 50mm D2 ø 82mm thickness 2mm with 6 holes wash arm support equiv. no. 437014 suitable for COLGED		
<b>For models:</b>	D500LS, D501LS		



<b>GEV No.</b>	518339	<b>Ref. No.</b>	437064
<b>description</b>	gasket D2 ø 50mm thickness 2mm with 3 screw holes wash arm support equiv. no. 437064 suitable for COLGED hole ø 50mm hole distance 67mm		
<b>For models:</b>	D500LS, D501LS		





Зип Общепит

vsezip.ru

+7(812)987-08-81

type TS2/TE2			
1			
<b>GEV No.</b>	750014	<b>Ref. No.</b>	01859700R
<b>description</b>	expansion valve DANFOSS type TS2 coolant R404a/R507 angled 90° thermostatically controlled inlet 3/8" SAE outlet 1/2" SAE p max 34bar -40 up to +10°C capillary pipe 1500mm		
<b>accessories for</b>	750014		
	<b>GEV No.</b>	<b>Ref. No.</b>	
	750020	—	
	nozzle insert size 0X type 068-2002 T/TE 2 DANFOSS		
	750021	01348500R	
	nozzle insert size 00 type 068-2003 T/TE 2 DANFOSS		
	750022	—	
	nozzle insert size 01 type 068-2010 T/TE 2 DANFOSS		
	750023	—	
	nozzle insert size 02 type 068-2015 T/TE 2 DANFOSS		
	750024	—	
	nozzle insert size 03 type 068-2006 T/TE 2 DANFOSS		
	750483	—	
	nozzle insert size 04 type 068-2007 T2/TE2 DANFOSS		
	750484	—	
	nozzle insert size 05 type 068-2008 T2/TE2 DANFOSS		
	750485	—	
	nozzle insert size 06 type 068-2009 T2/TE2 DANFOSS		

nozzle inserts			
1			
<b>GEV No.</b>	750021	<b>Ref. No.</b>	01348500R
<b>description</b>	nozzle insert size 00 type 068-2003 T/TE 2 DANFOSS		

type TX2/TEX2			
1			
<b>GEV No.</b>	750010	<b>Ref. No.</b>	01352700R
<b>description</b>	expansion valve DANFOSS type TX2 coolant R22/R407c angled 90° thermostatically controlled inlet 3/8" SAE outlet 1/2" SAE p max 34bar -40 up to +10°C capillary pipe 1500mm		

## evaporators for fridges

producer-specific			
1			
<b>GEV No.</b>	750123	<b>Ref. No.</b>	01264502R 01564501R 01564602R 02316700
<b>description</b>	evaporator L 380mm W 110mm H 150mm total length 400mm aluminium		

1			
<b>GEV No.</b>	750283	<b>Ref. No.</b>	FEQ321201Y Q32-1201Y
<b>description</b>	evaporator L 390mm W 315mm H 315mm H2 210mm		

1			
<b>GEV No.</b>	750124	<b>Ref. No.</b>	01152800R 02054001 020540-01R
<b>description</b>	evaporator L 420mm W 390mm H 35mm total length 470mm overall width 450mm overall height 40mm		

Зип-Общепит

vsezip.ru

7(812)987-08-81

1 

<b>GEV No.</b>	750120	<b>Ref. No.</b>	01152900R 01152901R 01152902R
<b>description</b>	evaporator L 455mm W 100mm H 150mm total length 490mm overall height 230mm mounting distance 1 435mm mounting distance 2 80mm		

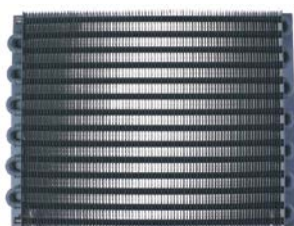
2 

<b>GEV No.</b>	750126	<b>Ref. No.</b>	01314500R
<b>description</b>	evaporator L 465mm W 360mm H 25mm		

1 

<b>GEV No.</b>	750121	<b>Ref. No.</b>	01153000R
<b>description</b>	evaporator L 610mm W 100mm H 150mm		

1 

<b>GEV No.</b>	693637	<b>Ref. No.</b>	RTCU700504
<b>description</b>	flange bearing type UCF204 shaft $\phi$ 20mm W 60mm 2 hole flange hole distance 90mm H 34mm L 114mm		

drive belts

V-belts

profile Z/10

1  

<b>GEV No.</b>	693400	<b>Ref. No.</b>	RTBF900125
<b>description</b>	V-belt belt width 10mm L 915mm H 6mm CODE Z36 profile Z/10		
<b>For models:</b>	MG099-03-012, MG099-13-012I		

springs

torsion springs

1 

<b>GEV No.</b>	690371	<b>Ref. No.</b>	01157200R
<b>description</b>	torsion spring $\phi$ 16.5mm wire gauge $\phi$ 2.6mm L1 32mm L2 101mm L3 13mm mounting pos. left		

1 

<b>GEV No.</b>	690370	<b>Ref. No.</b>	01157300R
<b>description</b>	torsion spring $\phi$ 16.5mm wire gauge $\phi$ 2.6mm L1 35mm L2 101mm L3 16mm mounting pos. right		

1 

<b>GEV No.</b>	693627	<b>Ref. No.</b>	RTBF800103
<b>description</b>	torsion spring $\phi$ 38.8mm wire gauge $\phi$ 7.2mm L1 33mm L2 280mm L3 20mm		
<b>For models:</b>	MG099-03-012, MG099-03-012M, MG099-13-012I, MG099-13-012IM		

compression springs

1 

<b>GEV No.</b>	690372	<b>Ref. No.</b>	01157400R
<b>description</b>	compression spring $\phi$ 20.6mm L 135mm wire gauge $\phi$ 2.9mm		

transmission technology and ball bearings

ball bearings

deep-groove ball bearings 2RS

1 

<b>GEV No.</b>	523509	<b>Ref. No.</b>	314001
<b>description</b>	deep-groove ball bearing type 6201-2RS shaft $\phi$ 12mm ED $\phi$ 32mm W 10mm with sealing discs deep-groove ball bearing DIN 625-1		
<b>For models:</b>	D500LS, D501LS		



## dosing pumps

### peristaltic dosing pumps

SEKO

built-in version

with frequency control



1

<b>GEV No.</b>	361767 <sup>1</sup>	<b>Ref. No.</b>	209021
<b>description</b>	dosing pump SEKO 3l/h 230VAC detergent hose ø 4x6mm hose type K hose Santoprene suction level 1.5m type NBR 3 8W built-in version peristaltic pump		
<b>For models:</b>	D500LS, D501LS		
<b>spare parts for</b>	361767		
	<b>GEV No.</b>	<b>Ref. No.</b>	—
	361815		
	pump hose detergent hose ø 6x10mm hose ø 4x6mm hose type K hose Santoprene type SEKO		

<sup>1</sup>incl. inlet and conveyor hose

### spare parts



1

<b>GEV No.</b>	698712	<b>Ref. No.</b>	143219
<b>description</b>	dosing hose SEKO detergent hose ø 4x8.6mm hose ø 4x6mm hose type H hose Santoprene		
<b>For models:</b>	D500LS, D501LS		

## membrane dosing pumps



### self-priming

LANG

accessories



1

<b>GEV No.</b>	101286	<b>Ref. No.</b>	RTCU900018
<b>description</b>	olive ID ø 6mm Qty 1 pcs		
<b>For models:</b>	MG077-03-003, MG077-03-004, MG077-03-005, MG077-13-003, MG077-13-004, MG077-13-005, MG117-03-110XL		
<b>accessories for</b>	101286		
	<b>GEV No.</b>	<b>Ref. No.</b>	
	100909		RTCP800038 RTCU900019
	union screw thread M10x1 for pipe ø 6mm Qty 1 pcs		
	<b>GEV No.</b>	<b>Ref. No.</b>	—
	101464		
	union nut thread M12x1 for pipe ø 6mm		

Зип-Общепит

vsezip.ru

+7(812)987-08-81



1

<b>GEV No.</b>	361364 <sup>1</sup>	<b>Ref. No.</b>	209025
<b>description</b>	dosing pump type DIB5E self-sucking rinse aid pump rate 0-5cm <sup>3</sup> per stroke pressure connection ø 4x6mm suction connection ø 4x6mm SEKO supporting pressure closed		
<b>For models:</b>	D500LS, D501LS		
<b>spare parts for</b>	361364		
	<b>GEV No.</b>	<b>Ref. No.</b>	—
	361301		
	hose connector for type DIB3E/DIB5E		
	<b>GEV No.</b>	<b>Ref. No.</b>	—
	361302		
	valve bush for type DIB3E/DIB5E		
	<b>GEV No.</b>	<b>Ref. No.</b>	—
	361304		
	O-ring EPDM ID ø 11.11mm thickness 1.78mm Qty 1 pcs for type DIB3E/DIB5E		
	<b>GEV No.</b>	<b>Ref. No.</b>	—
	361305		
	valve disc for type DIB3E/DIB5E DIB3P/DIB5P		
	<b>GEV No.</b>	<b>Ref. No.</b>	—
	361306		
	membrane for type DIB3E/DIB5E ø 49mm hole ø 5mm		
	<b>GEV No.</b>	<b>Ref. No.</b>	—
	361307		
	membrane dosing pump ø 68mm hole ø 6mm for type DIB3P/DIB5P		
	<b>GEV No.</b>	<b>Ref. No.</b>	—
	361459		
	hose connector ø 6mm for dosing pump		
	<b>GEV No.</b>	<b>Ref. No.</b>	—
	361481		
	lip valve for type DIB3P/DIB5P DIB3E/DIB5E		
<b>accessories for</b>	361364		
	<b>GEV No.</b>	<b>Ref. No.</b>	—
	361240		
	hose connector 1-way hose ø 6mm plastic connection M10x1		
	<b>GEV No.</b>	<b>Ref. No.</b>	—
	361241		
	hose connector 1-way hose ø 9mm plastic connection M10x1		

<sup>1</sup>auxiliary pressure connection closed

water and beverage technology

accessories

container filters



1	<b>GEV No.</b>	513043	<b>Ref. No.</b>	121017
	<b>description</b>	container filter hose ø 4mm		
	<b>For models:</b>	D500LS, D501LS		



1	<b>GEV No.</b>	361141	<b>Ref. No.</b>	121075
	<b>description</b>	container filter with weight ceramic hose ø 4mm		
	<b>For models:</b>	D500LS, D501LS		



1	<b>GEV No.</b>	361462	<b>Ref. No.</b>	121993
	<b>description</b>	container filter with weight SS hose ø 4x6mm		
	<b>For models:</b>	D500LS, D501LS		

hoses

PVC hoses



1	<b>GEV No.</b>	520090	<b>Ref. No.</b>	143194
	<b>description</b>	PVC hose ID ø 4mm ED ø 6mm L 2m thickness 1mm t.max. 60°C transparent		
	<b>For models:</b>	D500LS, D501LS		

**accessories for** 520090

	<b>GEV No.</b>	361058	<b>Ref. No.</b>	—
	<b>description</b>	container filter with non-return valve SS hose ø 4x6mm ø 20mm L 56mm		

	<b>GEV No.</b>	361066	<b>Ref. No.</b>	—
	<b>description</b>	container filter straight SS hose ø 4x6mm L 37mm non return valve ball valve		

	<b>GEV No.</b>	361106	<b>Ref. No.</b>	—
	<b>description</b>	container filter with weight and non-return valve SS hose ø 4x6mm ø 21mm L 51mm non return valve lip valve		

	<b>GEV No.</b>	361141	<b>Ref. No.</b>	121075
	<b>description</b>	container filter with weight ceramic hose ø 4mm		

	<b>GEV No.</b>	361230	<b>Ref. No.</b>	—
	<b>description</b>	container filter with weight stainless steel hose ø 4x6mm		

	<b>GEV No.</b>	361462	<b>Ref. No.</b>	121993
	<b>description</b>	container filter with weight SS hose ø 4x6mm		

<b>accessories for</b> 520090	<b>GEV No.</b>	361728	<b>Ref. No.</b>	—
	<b>description</b>	container filter with 4m 4x6 hose SS hose ø 4x6mm hose length 4.00m		

tank inlets



1	<b>GEV No.</b>	361270	<b>Ref. No.</b>	468151
	<b>description</b>	tank inlet SS M12 hose ø 4mm		
	<b>For models:</b>	D500LS, D501LS		

hoses

supply hoses

PVC supply hoses



1	<b>GEV No.</b>	520011	<b>Ref. No.</b>	929169
	<b>description</b>	supply hose PVC straight-curved DN13 connections 3/4" L 2000mm operating p. 10bar burst p. 32bar t.max. 90°C approval VDE flat seal		
	<b>For models:</b>	D500LS, D501LS		

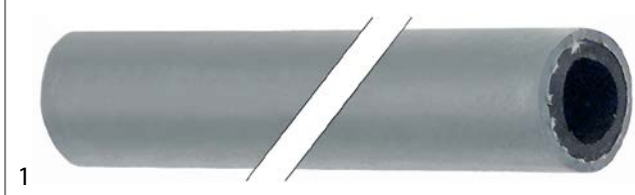

1	<b>GEV No.</b>	520015	<b>Ref. No.</b>	143004
	<b>description</b>	supply hose ID ø 10mm ED ø 17mm L 5m operating p. 20bar burst p. 60bar t.max. 95°C grey Qty 5m		
	<b>For models:</b>	D500LS, D501LS		

**accessories for** 520015

	<b>GEV No.</b>	504377	<b>Ref. No.</b>	—
	<b>description</b>	hose connector grommet ø 23mm grommet length 25mm total length 55mm for water filling		

drain hoses



1	<b>GEV No.</b>	513258	<b>Ref. No.</b>	127044
	<b>description</b>	drain hose DN19 L 270mm A int. ø 22mm A ext. ø 28mm B int. ø 24mm B ext. ø 28mm outer hose ø 22mm		
	<b>For models:</b>	D500LS, D501LS		



Зип Общепит

vsezip.ru  
+7(812)98708-81



1

<b>GEV No.</b>	518219	<b>Ref. No.</b>	127037
<b>description</b>	drain hose DN19 L 630mm A int. ø 20mm A ext. ø 27mm B int. ø 21mm B ext. ø 28mm outer hose ø 24mm		
<b>For models:</b>	D500LS, D501LS		

industrial hoses

pressure control hoses



1

<b>GEV No.</b>	530560	<b>Ref. No.</b>	143005
<b>description</b>	pressure control hose ID ø 5mm ED ø 9mm L 5m operating p. 30bar burst p. 90bar temp.-resist. 60°C		
<b>For models:</b>	D500LS, D501LS		

PVC hoses

PVC hoses without fabric







1

<b>GEV No.</b>	520383	<b>Ref. No.</b>	H.775601
<b>description</b>	PVC hose ID ø 4mm ED ø 6mm L 2m thickness 1mm t.max. 60°C blue		
<b>For models:</b>	D500LS, D501LS		
<b>accessories for</b>	520383		
	<b>GEV No.</b>	361058	<b>Ref. No.</b> —
	container filter with non-return valve SS hose ø 4x6mm ø 20mm L 56mm		
	<b>GEV No.</b>	361066	<b>Ref. No.</b> —
	container filter straight SS hose ø 4x6mm L 37mm non return valve ball valve		
	<b>GEV No.</b>	361106	<b>Ref. No.</b> —
	container filter with weight and non-return valve SS hose ø 4x6mm ø 21mm L 51mm non return valve lip valve		
	<b>GEV No.</b>	361141	<b>Ref. No.</b> 121075
	container filter with weight ceramic hose ø 4mm		
	<b>GEV No.</b>	361230	<b>Ref. No.</b> —
	container filter with weight stainless steel hose ø 4x6mm		
	<b>GEV No.</b>	361462	<b>Ref. No.</b> 121993
	container filter with weight SS hose ø 4x6mm		
	<b>GEV No.</b>	361728	<b>Ref. No.</b> —
	container filter with 4m 4x6 hose SS hose ø 4x6mm hose length 4000mm		



1

<b>GEV No.</b>	520090	<b>Ref. No.</b>	143194
<b>description</b>	PVC hose ID ø 4mm ED ø 6mm L 2m thickness 1mm t.max. 60°C transparent		
<b>For models:</b>	D500LS, D501LS		
<b>accessories for</b>	520090		
	<b>GEV No.</b>	361058	<b>Ref. No.</b> —
	container filter with non-return valve SS hose ø 4x6mm ø 20mm L 56mm		
	<b>GEV No.</b>	361066	<b>Ref. No.</b> —
	container filter straight SS hose ø 4x6mm L 37mm non return valve ball valve		
	<b>GEV No.</b>	361106	<b>Ref. No.</b> —
	container filter with weight and non-return valve SS hose ø 4x6mm ø 21mm L 51mm non return valve lip valve		
	<b>GEV No.</b>	361141	<b>Ref. No.</b> 121075
	container filter with weight ceramic hose ø 4mm		
	<b>GEV No.</b>	361230	<b>Ref. No.</b> —
	container filter with weight stainless steel hose ø 4x6mm		
	<b>GEV No.</b>	361462	<b>Ref. No.</b> 121993
	container filter with weight SS hose ø 4x6mm		
	<b>GEV No.</b>	361728	<b>Ref. No.</b> —
	container filter with 4m 4x6 hose SS hose ø 4x6mm hose length 4000mm		



1

<b>GEV No.</b>	520027	<b>Ref. No.</b>	143013
<b>description</b>	PVC hose ID ø 4mm ED ø 7mm L 10m thickness 1.5mm t.max. 60°C transparent		
<b>For models:</b>	D500LS, D501LS		

formed hoses

straight



1

<b>GEV No.</b>	518070	<b>Ref. No.</b>	127026
<b>description</b>	formed hose dishwasher straight mounting pos. upper equiv. no. 127026		
<b>For models:</b>	D500LS, D501LS		

Зип.Общепит  
fittings, hose and pipe connectors

hose connectors

without screw connection

+7(812)987-08-81  
vsezip.ru



1

<b>GEV No.</b>	5411109	<b>Ref. No.</b>	035031
<b>description</b>	Y-piece plastic hose ø 8-6-8mm for pressure switch		
<b>For models:</b>	D500LS, D501LS		

hose connectors

brass



1

<b>GEV No.</b>	513253	<b>Ref. No.</b>	DZR2915
<b>description</b>	hose connector brass angled thread 1/4" hose ø 12mm Qty 1 pcs		
<b>For models:</b>	LB03100000, LB03300000, LP05500010		

valves and tank inlets

ball valves

universal

ball valves with lever handle



1

<b>GEV No.</b>	514325	<b>Ref. No.</b>	RTBF800073
<b>description</b>	ball valve connection 1" IT - 1" IT DN25 total length 83mm with lever handle		
<b>For models:</b>	LX7EC4		



1

<b>GEV No.</b>	518380	<b>Ref. No.</b>	127036
<b>description</b>	formed hose ext. ø 53 ID ø 43mm L 65mm dishwasher straight mounting pos. upper equiv. no. 127036		
<b>For models:</b>	D500LS, D501LS		

form L



1

<b>GEV No.</b>	518225	<b>Ref. No.</b>	127041
<b>description</b>	formed hose warewashing L-shape equiv. no. 127041		
<b>For models:</b>	D500LS, D501LS		

form U



1

<b>GEV No.</b>	518517	<b>Ref. No.</b>	127050
<b>description</b>	formed hose for drain pump D1 ø 28mm D2 ø 21mm warewashing U-shape		
<b>For models:</b>	D500LS, D501LS		

for dishwashers

ventilation hoses



1

<b>GEV No.</b>	513265	<b>Ref. No.</b>	143189
<b>description</b>	ventilation hose ext. ø 17 ID ø 14mm L 75mm warewashing back-flow restrictor		
<b>For models:</b>	D500LS, D501LS		



3 ил. Общепит. measuring equipment

vsezip.ru +7(812)987-08-81

shut-off valves

accessories



1			
<b>GEV No.</b>	540866	<b>Ref. No.</b>	RTCU900491
<b>description</b>	rosette		
<b>For models:</b>	ME066-03-008, MG066-03-008		

inlet taps



1			
<b>GEV No.</b>	542006	<b>Ref. No.</b>	RTBF800041
<b>description</b>	inlet spout connection 3/8" ET tube ø 16mm H1 90mm H2 40mm L 80mm pipe connection ø 10mm 1/2" ET		
<b>For models:</b>	MG099-03-012, MG099-03-012M, MG099-13-012I, MG099-13-012IM		

ancillary products

clamps

double wire clamps



1			
<b>GEV No.</b>	513268	<b>Ref. No.</b>	423011
<b>description</b>	hose clamp ø 8-10mm wire gauge ø 1mm Qty 1 pcs		
<b>For models:</b>	D500LS, D501LS		

pipes

miscellaneous



1			
<b>GEV No.</b>	693827	<b>Ref. No.</b>	PABF800292
<b>description</b>	water pipe		
<b>For models:</b>	MG099-03-012, MG099-03-012M, MG099-13-012I, MG099-13-012IM		

thermometers

built-in thermometers

ø52mm



1			
<b>GEV No.</b>	541413	<b>Ref. No.</b>	RIC0003065
<b>description</b>	thermometer mounting ø 52mm t.max. 120°C 0 up to +120°C probe ø 6mm probe L 36mm capillary pipe 1500mm		

fastening material

screws

knurled screws



1			
<b>GEV No.</b>	510112	<b>Ref. No.</b>	454002
<b>description</b>	Thumb screw thread M10 thread L 10mm ø 22mm H 4.5mm SS		
<b>For models:</b>	D500LS, D501LS		

nuts

knurled nuts



1			
<b>GEV No.</b>	517444	<b>Ref. No.</b>	80697
<b>description</b>	knurled nut thread M10x1 ø 25mm H 4mm SS		
<b>For models:</b>	D500LS, D501LS		

hexagonal nuts

hexagonal nuts metric (without norm)



1			
<b>GEV No.</b>	521134	<b>Ref. No.</b>	417017
<b>description</b>	hexagonal nut thread M14x1 SS		
<b>For models:</b>	D500LS, D501LS		

Зип-Общепит

DIN 7993

vsezip.ru

+7(812)987-08-81



1

<b>GEV No.</b>	105567	<b>Ref. No.</b>	RTCU900005
<b>description</b>	nut thread M16x1 H 4.5mm WS 19 zinc-coated steel Qty 1 pcs		
<b>For models:</b>	MG046-03-004, MG066-03-007, MG066-03-008, MG077-03-003, MG077-03-004, MG077-03-005, MG077-13-003, MG077-13-004, MG077-13-005		



1

<b>GEV No.</b>	102680	<b>Ref. No.</b>	RTCU600052
<b>description</b>	nut thread M6x0.75 H 2.6mm WS 8 brass Qty 1 pcs type SEF 2		
<b>For models:</b>	ME066-03-010, ME106-03-010XL, MG066-03-010, MG106-03-010, MG106-03-010XL		



1

<b>GEV No.</b>	102067	<b>Ref. No.</b>	9404701700
<b>description</b>	nut thread M8x1 H 3mm brass Qty 1 pcs type SEF 1		
<b>For models:</b>	MG066-03-010, MG106-03-010, MG106-03-010XL		

## fasteners

## clamps

## double wire clamps



1

<b>GEV No.</b>	513268	<b>Ref. No.</b>	423011
<b>description</b>	hose clamp ø 8-10mm wire gauge ø 1mm Qty 1 pcs		
<b>For models:</b>	D500LS, D501LS		

## retaining rings

## DIN 471



1

<b>GEV No.</b>	510244	<b>Ref. No.</b>	RTMIN00283
<b>description</b>	retaining ring shaft ø 60mm thickness 2mm steel DIN 471		
<b>For models:</b>	ME046-03-004, ME066-03-007		

1

<b>GEV No.</b>	518308	<b>Ref. No.</b>	303019
<b>description</b>	retaining ring Din 7993 for drain assembly thickness 3mm ED ø 57mm		
<b>For models:</b>	D500LS, D501LS		

## consumables

## lava rocks / ceramic briquetts



1

<b>GEV No.</b>	211001	<b>Ref. No.</b>	A800001170
<b>description</b>	lava rocks Qty package content 9kg		
<b>For models:</b>	MG086-13-014P		

## fuses

## fine fuses



1

<b>GEV No.</b>	358677	<b>Ref. No.</b>	228010
<b>description</b>	fine fuse size ø5x20mm 4A fast-acting rated 250V Qty 10 pcs		
<b>For models:</b>	D500LS, D501LS		



Зип Общепит

vsezip.ru

+7(812)987-08-81

<b>A</b>		<b>G</b>	
axial fans	27	gas burners	41
<b>B</b>		gas control valves	35
ball valves	70	gas nozzles	45
bar burners	43	gas taps	32
bi-metal thermostats	9	gas thermostats	33
<b>C</b>		gaskets for heated units	62
cam switches	15	gaskets for wash arm support	64
ceramic heaters	5	grates	58
clamps	71, 72	<b>H</b>	
cold air circulating fans (complete)	28	handle latches	53
compressors	26	heating cables	5
condensators & interference suppression filters	31	heating elements	3
consumables	72	heating elements for bain maries	3
contactors	19	heating elements for condensate evaporation	4
container filters	68	heating elements for convection	6
control equipment	16	heating elements for defrosting	4
control thermostats	9, 11	heating elements for fryers	3
core probes	22	heating elements for frying pans	3
cross flow fans	29	heating elements for griddles	4
<b>D</b>		heating elements for heated cabinets	5
defrost timers	18	heating elements for ovens	3
door gaskets (wire reinforced)	62	heating elements for pasta cookers	5
door seals	62	heating elements for refrigeration	4
door seals for dishwashers	64	hexagonal nuts	71
door seals with fixing hook	62	hob burners	41
dosing pumps	67	hose connectors	70, 70
double wire clamps	71, 72	hoses	68
drain hoses	68	hot air fans	29
drain pumps	31	hot plates	8
<b>E</b>		<b>I</b>	
edgemount hinges	53	ignition cables	38
edgemount latches	53	ignition units	39
electric accessories	32	immersion heating elements	6
electronic controllers	20	indicator lights	16
energy regulators	9	indicator lights (complete)	16
evaporators	65	industrial hoses	69
expansion valves	64	inlet spouts	71
<b>F</b>		inlet taps	71
fans	27	<b>K</b>	
fasteners	72	knurled nuts	71
fastening material	71	knurled screws	71
fine fuses	72	<b>L</b>	
foil heating elements	7	lamps	16
formed hoses	69	lava rocks / ceramic briquetts	47, 72
fuses	31, 72	light bulbs	17

Зип Общепит

vsezip.ru

+7(812)987-08-81

<b>M</b>			
magnetic switches	16	switches and momentary switches	13
measuring equipment	71	system switches (ROLD)	14
microswitches	14		
motors	30	<b>T</b>	
		tank inlets	68
		temperature probes	22
		terminals	32
		thermocouples	39
<b>N</b>		thermostats	9
nuts	71	time relays	19
		timers	18
		transformers	20
		tube burners	44
		<b>U</b>	
		universal probes	22
		<b>V</b>	
		valves and tank inlets	70
		ventilation hoses	70
		<b>W</b>	
		walk-in fridge catches	53
		wash and rinse pumps	30
<b>O</b>			
operating capacitors	31		
O-rings	62		
oven hinges	54		
oven lamps	18		
<b>P</b>			
piezoelectric igniters	38		
pilot burners	35		
plug-in gaskets	59		
pressure control hoses	69		
pressure switches	25		
probes	22		
programme timers	18		
pumps	30		
pumps for ice machines	31		
push/momentary push switches	13		
PVC hoses	69		
PVC supply hoses	68		
<b>R</b>			
radiation heaters	7		
refrigeration cycle components	64		
refrigeration fans	28		
refrigeration gaskets	59		
refrigeration motors universal	28		
refrigeration thermostats	12		
relays	19		
retaining rings	72		
rocker/momentary rocker switches	13		
<b>S</b>			
safety bi-metal thermostats	9		
safety thermostats	10		
screw-in gaskets	60		
screws	71		
sealing washers	63		
shelves and shelf rails	58		
shut-off valves	71		
solenoid valves	23		
spring assisted hinges	54		
starting capacitors	31		
supply hoses	68		