



pumps

wash and rinse pumps

LGB



1

GEV No.	500334	Ref. No.	111130 ZF130SX
description	pump inlet \varnothing 1½" IT outlet \varnothing 1" ET type ZF130SX 230V 50Hz 1 phase 0,37kW 0,54HP L 220mm rotation direction right capacitor 10 μ F LGB inlet \varnothing 1¼" ITmm outlet \varnothing 1" ETmm		
spare parts for	500334		
	GEV No.	365012	Ref. No. —
	operating capacitor capacity 6,3 μ F 450V		
	GEV No.	510122	Ref. No. 0002R
	pump cover LGB inlet \varnothing 28 mm outlet \varnothing 26 mm		
	GEV No.	510703	Ref. No. 1001R 1058R N/A
	mechanical shaft seal for shaft \varnothing 13 mm		
	GEV No.	521085	Ref. No. 0106-1R
	impellor \varnothing 72 mm H 17 mm thread M7L shaft \varnothing 13 mm		
	GEV No.	528800	Ref. No. 0042R
	O-ring EPDM thickness 2,62 mm ID \varnothing 75,87 mm		
accessories for	500334		
	GEV No.	503030	Ref. No. —
	round filters outflow		
	GEV No.	503108	Ref. No. —
	round filters outflow		
	GEV No.	506015	Ref. No. —
	O-ring EPDM thickness 3,53mm ID \varnothing 39,69mm		
	GEV No.	510072	Ref. No. —
	O-ring EPDM thickness 3,53mm ID \varnothing 32,93mm		

Зип Общепит

vsezip.ru

+7(812)987-08-81







1

GEV No.	499220	Ref. No.	GISH35-V D55
description	pump inlet \varnothing 1½" outlet \varnothing 1½" type GISH35-V D55 230V 50Hz 1 phase 0,17kW L 230mm rotation direction right capacitor 5 μ F LGB		
spare parts for	499220		
	GEV No.	365017	Ref. No. —
	operating capacitor capacity 5 μ F 450V		



1

GEV No.	500599	Ref. No.	2349-1 2349A ZF131DX
description	pump inlet \varnothing 28mm outlet \varnothing 12mm type ZF131DX 230V 50Hz 1 phase 0,16kW 0,22HP L 175mm rotation direction left capacitor 6,3 μ F LGB		
spare parts for	500599		
	GEV No.	365012	Ref. No. —
	operating capacitor capacity 6,3 μ F 450V		
	GEV No.	510703	Ref. No. 1001R 1058R N/A
	mechanical shaft seal for shaft \varnothing 13 mm		
	GEV No.	521119	Ref. No. 2135R
	pump cover LGB inlet \varnothing 28 mm outlet \varnothing 12 mm		
	GEV No.	521228	Ref. No. 0105-1R
	impellor \varnothing 72 mm H 17 mm rotation direction left		
	GEV No.	528800	Ref. No. 0042R
	O-ring EPDM thickness 2,62 mm ID \varnothing 75,87 mm		

Зип Общественит

vsezip.ru

+7(812)987-08-81



1

GEV No.	501503	Ref. No.	C.F.2745 LA 40 SX
description	pump inlet ø 28mm outlet ø 22/27mm type CF 2745 230V 50Hz 1 phase 0,19kW L 175mm rotation direction right capacitor 4µF LGB with capacitor		
spare parts for	501503		
	GEV No.	Ref. No.	—
	operating capacitor capacity 4µF 450V		
	GEV No.	Ref. No.	Guarnizione per Pompa CRC-R DX EPR 2570A
	O-ring EPDM thickness 2,62mm ID ø 82,22mm		
	GEV No.	Ref. No.	1001R 1058R N/A
	mechanical shaft seal for shaft ø 13 mm		
	GEV No.	Ref. No.	N/A
	impellor ø 70 mm H 21 mm rotation direction right		
	GEV No.	Ref. No.	N/A
	pump cover LGB inlet ø 28 mm outlet ø 22/28mm		



1

GEV No.	501525	Ref. No.	CF 3091 LA 40 SX
description	pump inlet ø 28mm outlet ø 22/27mm type CF 3091 230V 60Hz 1 phase 0,2kW L 175mm rotation direction right capacitor 4µF LGB with capacitor		
spare parts for	501525		
	GEV No.	Ref. No.	—
	operating capacitor capacity 4µF 450V		

spare parts for	501525		
	GEV No.	Ref. No.	Guarnizione per Pompa CRC-R DX EPR 2570A
	O-ring EPDM thickness 2,62mm ID ø 82,22mm		
	GEV No.	Ref. No.	1001R 1058R N/A
	mechanical shaft seal for shaft ø 13 mm		
	GEV No.	Ref. No.	N/A
	impellor ø 70 mm H 21 mm rotation direction right		
	GEV No.	Ref. No.	N/A
	pump cover LGB inlet ø 28 mm outlet ø 22/28mm		



1

GEV No.	499099	Ref. No.	CRC-R DX 2570 EPR2570 EPR2570A
description	pump inlet ø 28mm outlet ø 26mm type CRC-R DX 230V 50Hz 1 phase 0,2kW L 175mm rotation direction left capacitor 4µF LGB		
spare parts for	499099		
	GEV No.	Ref. No.	—
	operating capacitor capacity 4µF 450V		
	GEV No.	Ref. No.	Guarnizione per Pompa CRC-R DX EPR 2570A
	O-ring EPDM thickness 2,62mm ID ø 82,22mm		
	GEV No.	Ref. No.	1001R 1058R N/A
	mechanical shaft seal for shaft ø 13 mm		
	GEV No.	Ref. No.	2576R
	pump cover LGB inlet ø 28 mm outlet ø 26 mm		
	GEV No.	Ref. No.	2574R Girante per Pompa CRC-R DX EPR2570A
	impellor ø 80 mm H 25 mm pump type CRC-R DX		



electric components

Зип-Общесит

vsezip.ru





+7(812)987-08-81







GEV No.	501526	Ref. No.	2582-1 CRC-R DX 60 HZ
description	pump inlet ø 28mm outlet ø 26mm type CRC-R DX 230V 60Hz 1 phase 0,21kW L 175mm rotation direction left capacitor 4µF LGB		
spare parts for	501526		
	GEV No.	365031	Ref. No. —
	operating capacitor capacity 4µF 450V		
	GEV No.	509002	Ref. No. Guarnizione per Pompa CRC-R DX EPR 2570A
	O-ring EPDM thickness 2,62mm ID ø 82,22mm		
	GEV No.	510703	Ref. No. 1001R 1058R N/A
	mechanical shaft seal for shaft ø 13 mm		
	GEV No.	521091	Ref. No. 2576R
	pump cover LGB inlet ø 28 mm outlet ø 26 mm		
	GEV No.	521092	Ref. No. 2574R Girante per Pompa CRC-R DX EPR2570A
	impellor ø 80 mm H 25 mm pump type CRC-R DX		



GEV No.	499061	Ref. No.	2753-1 ZF115SX EPR2753
description	pump inlet ø 28mm outlet ø 26mm type ZF115SX 230V 50Hz 1 phase 0,21kW L 190mm capacitor 5µF LGB		
spare parts for	499061		
	GEV No.	365017	Ref. No. —
	operating capacitor capacity 5µF 450V		

	GEV No.	510122	Ref. No.	0002R
	pump cover LGB inlet ø 28 mm outlet ø 26 mm			
	GEV No.	510703	Ref. No.	1001R 1058R N/A
	mechanical shaft seal for shaft ø 13 mm			
	GEV No.	521221	Ref. No.	N/A
	impellor ø 67 mm H 16 mm rotation direction right			
	GEV No.	528800	Ref. No.	0042R
	O-ring EPDM thickness 2,62 mm ID ø 75,87 mm			



GEV No.	500353	Ref. No.	EPR0499 ZF115SX	
description	pump inlet ø 28mm outlet ø 26mm type ZF115SX 230V 50Hz 1 phase 0,2kW 0,27HP L 190mm rotation direction right capacitor 5µF LGB			
spare parts for	500353			
	GEV No.	365017	Ref. No. —	
	operating capacitor capacity 5µF 450V			
	GEV No.	510122	Ref. No.	0002R
	pump cover LGB inlet ø 28 mm outlet ø 26 mm			
	GEV No.	510703	Ref. No.	1001R 1058R N/A
	mechanical shaft seal for shaft ø 13 mm			
	GEV No.	521223	Ref. No.	1517R
	impellor ø 61 mm H 17 mm thread M7L shaft ø 13 mm			
	GEV No.	528800	Ref. No.	0042R
	O-ring EPDM thickness 2,62 mm ID ø 75,87 mm			

Зип Общепит

vsezip.ru

+7(812)987-08-81



1

GEV No.	500342	Ref. No.	ZF119SX (BL19655)
description	pump inlet ø 28mm outlet ø 26mm type ZF119DX 230V 50Hz 1 phase 0,2kW 0,27HP L 186mm rotation direction left capacitor 5µF LGB		





1

GEV No.	500936	Ref. No.	ZF119SX
description	pump inlet ø 28mm outlet ø 26mm type ZF119SX 230V 50Hz 1 phase 0,24kW 0,33HP L 190mm rotation direction right capacitor 5µF LGB		
spare parts for	500936		
	GEV No.	365017	Ref. No. —
	operating capacitor capacity 5µF 450V		
	GEV No.	521057	Ref. No. 1650R
	pump cover LGB inlet ø 28 mm outlet ø 26 mm		
	GEV No.	528800	Ref. No. 0042R
	O-ring EPDM thickness 2,62 mm ID ø 75,87 mm		
accessories for	500936		
	GEV No.	550964	Ref. No. —
	fastening angle for pump		



1

GEV No.	499204	Ref. No.	ZF119SX
description	pump inlet ø 28mm outlet ø 26mm type ZF119SX 230V 50Hz 1 phase 0,15kW 0,2HP L 195mm rotation direction right capacitor 5µF auxiliary pressure connection 12mm LGB		
spare parts for	499204		
	GEV No.	365017	Ref. No. —
	operating capacitor capacity 5µF 450V		
	GEV No.	510703	Ref. No. 1001R 1058R N/A
	mechanical shaft seal for shaft ø 13 mm		
	GEV No.	521057	Ref. No. 1650R
	pump cover LGB inlet ø 28 mm outlet ø 26 mm		
	GEV No.	521114	Ref. No. Girante per Pompa ZF119SX C.F.2126
	impellor ø 48 mm H 17 mm pump type ZF119SX		
	GEV No.	528800	Ref. No. 0042R
	O-ring EPDM thickness 2,62 mm ID ø 75,87 mm		



1





GEV No.	499132	Ref. No.	EPR2894 ZF121SX
description	pump inlet ø 28mm outlet ø 26mm type ZF121SX 230V 50Hz 1 phase 0,11kW 0,15HP L 195mm rotation direction right capacitor 6,3µF LGB		
spare parts for	499132		
	GEV No.	365012	Ref. No. —
	operating capacitor capacity 6,3µF 450V		
	GEV No.	510703	Ref. No. 1001R 1058R N/A
	mechanical shaft seal for shaft ø 13 mm		

Table continues overleaf



spare parts for 499132

	GEV No.	521057	Ref. No.	1650R
pump cover LGB inlet ø 28 mm outlet ø 26 mm				
	GEV No.	521085	Ref. No.	0106-1R
impellor ø 72 mm H 17 mm thread M7L shaft ø 13 mm				
	GEV No.	528800	Ref. No.	0042R
O-ring EPDM thickness 2,62 mm ID ø 75,87 mm				



1	GEV No.	500542	Ref. No.	EPR0459 ZF130DX
description pump inlet ø 28mm outlet ø 26mm type ZF130DX 230V 50Hz 1 phase 0,3kW 0,41HP L 190mm rotation direction left capacitor 6,3µF LGB				
spare parts for 500542				
	GEV No.	365012	Ref. No.	—
operating capacitor capacity 6,3µF 450V				
	GEV No.	510703	Ref. No.	1001R 1058R N/A
mechanical shaft seal for shaft ø 13 mm				
	GEV No.	521107	Ref. No.	0001R
pump cover LGB inlet ø 28 mm outlet ø 26 mm				
	GEV No.	521228	Ref. No.	0105-1R
impellor ø 72 mm H 17 mm rotation direction left				
	GEV No.	528800	Ref. No.	0042R
O-ring EPDM thickness 2,62 mm ID ø 75,87 mm				

Зип Общепит

vsezip.ru

+7(812)987-08-81



1	GEV No.	500494	Ref. No.	C.F0551 EPR0551 ZF130DX
description pump inlet ø 28mm outlet ø 26mm type ZF130DX 230V 50Hz 1 phase 0,3kW 0,4HP L 200mm rotation direction left capacitor 6,3µF LGB				
spare parts for 500494				
	GEV No.	365012	Ref. No.	—
operating capacitor capacity 6,3µF 450V				
	GEV No.	510703	Ref. No.	1001R 1058R N/A
mechanical shaft seal for shaft ø 13 mm				
	GEV No.	521107	Ref. No.	0001R
pump cover LGB inlet ø 28 mm outlet ø 26 mm				
	GEV No.	521228	Ref. No.	0105-1R
impellor ø 72 mm H 17 mm rotation direction left				
	GEV No.	528800	Ref. No.	0042R
O-ring EPDM thickness 2,62 mm ID ø 75,87 mm				







1	GEV No.	500352	Ref. No.	EPR0500 ZF130SX
description pump inlet ø 28mm outlet ø 26mm type ZF130SX 230V 50Hz 1 phase 0,2kW 0,27HP L 195mm rotation direction right capacitor 6,3µF LGB				
spare parts for 500352				
	GEV No.	365012	Ref. No.	—
operating capacitor capacity 6,3µF 450V				
	GEV No.	510122	Ref. No.	0002R
pump cover LGB inlet ø 28 mm outlet ø 26 mm				

Table continues overleaf

Зип Общественит



vsezip.ru

+7(812)987-08-81

spare parts for 500352			
	GEV No.	510703	Ref. No. 1001R 1058R N/A
mechanical shaft seal for shaft \varnothing 13 mm			
	GEV No.	521085	Ref. No. 0106-1R
impellor \varnothing 72 mm H 17 mm thread M7L shaft \varnothing 13 mm			
	GEV No.	528800	Ref. No. 0042R
O-ring EPDM thickness 2,62 mm ID \varnothing 75,87 mm			







1

GEV No.	500583	Ref. No.	EPR1219 ZF130SX
description	pump inlet \varnothing 28mm outlet \varnothing 26mm type ZF130SX 230V 50Hz 1 phase 0,2kW 0,27HP L 195mm rotation direction right capacitor 6,3 μ F LGB		
spare parts for 500583			
	GEV No.	509004	Ref. No. 0951R
impellor \varnothing 71 mm H 16 mm M7L			
	GEV No.	510703	Ref. No. 1001R 1058R N/A
mechanical shaft seal for shaft \varnothing 13 mm			







1

GEV No.	500382	Ref. No.	EPR0542 ZF131DX
description	pump inlet \varnothing 28mm outlet \varnothing 26mm type ZF131DX 230V 50Hz 1 phase 0,2kW 0,26HP L 180mm rotation direction left capacitor 6,3 μ F LGB		
spare parts for 500382			
	GEV No.	365012	Ref. No. —
operating capacitor capacity 6,3 μ F 450V			
	GEV No.	510703	Ref. No. 1001R 1058R N/A
mechanical shaft seal for shaft \varnothing 13 mm			
	GEV No.	521228	Ref. No. 0105-1R
impellor \varnothing 72 mm H 17 mm rotation direction left			

spare parts for 500382			
	GEV No.	521524	Ref. No. 0882R
pump cover LGB inlet \varnothing 28 mm outlet \varnothing 26 mm			
	GEV No.	528800	Ref. No. 0042R
O-ring EPDM thickness 2,62 mm ID \varnothing 75,87 mm			



1





GEV No.	500555	Ref. No.	EPR0532 ZF131DX
description	pump inlet \varnothing 28mm outlet \varnothing 26mm type ZF131DX 230V 50Hz 1 phase 0,2kW 0,27HP L 195mm rotation direction left capacitor 6,3 μ F auxiliary pressure connection 12mm supporting pressure closed LGB		
spare parts for 500555			
	GEV No.	365012	Ref. No. —
operating capacitor capacity 6,3 μ F 450V			
	GEV No.	510703	Ref. No. 1001R 1058R N/A
mechanical shaft seal for shaft \varnothing 13 mm			
	GEV No.	521228	Ref. No. 0105-1R
impellor \varnothing 72 mm H 17 mm rotation direction left			
	GEV No.	521524	Ref. No. 0882R
pump cover LGB inlet \varnothing 28 mm outlet \varnothing 26 mm			
	GEV No.	528800	Ref. No. 0042R
O-ring EPDM thickness 2,62 mm ID \varnothing 75,87 mm			



Зип-Общепит

spare parts for 499301







1

GEV No.	500582	Ref. No.	EPR1002 EPR1453 ZF131DX 1002
description	pump inlet \varnothing 28mm outlet \varnothing 26mm type ZF131DX 230V 50Hz 1 phase 0,2kW 0,27HP L 195mm rotation direction left capacitor 6,3 μ F LGB		
spare parts for	500582		
	GEV No.	365012	Ref. No. —
	operating capacitor capacity 6,3 μ F 450V		
	GEV No.	510703	Ref. No. 1001R 1058R N/A
	mechanical shaft seal for shaft \varnothing 13 mm		
	GEV No.	521084	Ref. No. 1263R
	pump cover LGB inlet \varnothing 28 mm outlet \varnothing 25 mm		
	GEV No.	521228	Ref. No. 0105-1R
	impellor \varnothing 72 mm H 17 mm rotation direction left		
	GEV No.	528800	Ref. No. 0042R
	O-ring EPDM thickness 2,62 mm ID \varnothing 75,87 mm		

	GEV No.	521228	Ref. No.	0105-1R
	impellor \varnothing 72 mm H 17 mm rotation direction left			
	GEV No.	528800	Ref. No.	0042R
	O-ring EPDM thickness 2,62 mm ID \varnothing 75,87 mm			





1

GEV No.	500094	Ref. No.	EPR0744 ZF131SX
description	pump inlet \varnothing 28mm outlet \varnothing 26mm type ZF131SX 230V 50Hz 1 phase 0,2kW 0,15HP L 195mm rotation direction left capacitor 6,3 μ F LGB		
spare parts for	500094		
	GEV No.	365012	Ref. No. —
	operating capacitor capacity 6,3 μ F 450V		
	GEV No.	502266	Ref. No. 0881R
	pump cover inlet \varnothing 28 mm outlet \varnothing 26 mm		
	GEV No.	510703	Ref. No. 1001R 1058R N/A
	mechanical shaft seal for shaft \varnothing 13 mm		
	GEV No.	521085	Ref. No. 0106-1R
	impellor \varnothing 72 mm H 17 mm thread M7L shaft \varnothing 13 mm		
	GEV No.	528800	Ref. No. 0042R
	O-ring EPDM thickness 2,62 mm ID \varnothing 75,87 mm		



1

GEV No.	499301	Ref. No.	EPR1644 ZF131DX
description	pump inlet \varnothing 28mm outlet \varnothing 26mm type ZF131DX 230V 50Hz 1 phase 0,2kW L 195mm rotation direction left capacitor 6,3 μ F LGB		
spare parts for	499301		
	GEV No.	365012	Ref. No. —
	operating capacitor capacity 6,3 μ F 450V		
	GEV No.	510703	Ref. No. 1001R 1058R N/A
	mechanical shaft seal for shaft \varnothing 13 mm		
	GEV No.	521084	Ref. No. 1263R
	pump cover LGB inlet \varnothing 28 mm outlet \varnothing 25 mm		

Зип Общественит

vsezip.ru

+7(812)987-08-81



1			
GEV No.	500539	Ref. No.	EPR0861 EPR0861A ZF170SX
description	pump inlet ø 28mm outlet ø 26mm type ZF170SX 230V 50Hz 1 phase 0,32kW 0,44HP L 200mm rotation direction right capacitor 8µF LGB		
spare parts for	500539		
	GEV No.	365013	Ref. No. —
	operating capacitor capacity 8µF 400V		
	GEV No.	509004	Ref. No. 0951R
	impellor ø 71 mm H 16 mm M7L		
	GEV No.	510703	Ref. No. 1001R 1058R N/A
	mechanical shaft seal for shaft ø 13 mm		
	GEV No.	521057	Ref. No. 1650R
	pump cover LGB inlet ø 28 mm outlet ø 26 mm		
	GEV No.	528800	Ref. No. 0042R
	O-ring EPDM thickness 2,62 mm ID ø 75,87 mm		

spare parts for	500510		
	GEV No.	521057	Ref. No. 1650R
	pump cover LGB inlet ø 28 mm outlet ø 26 mm		
	GEV No.	521225	Ref. No. 0110-1R
	impellor ø 72 mm H 22 mm rotation direction right		
	GEV No.	528800	Ref. No. 0042R
	O-ring EPDM thickness 2,62 mm ID ø 75,87 mm		



1			
GEV No.	500460	Ref. No.	EPR1800 ZFC119DX
description	pump inlet ø 28mm outlet ø 26mm type ZFC119DX 230V 50Hz 1 phase 0,2kW 0,27HP L 180mm rotation direction left capacitor 5µF LGB		



1			
GEV No.	500979	Ref. No.	EPR1810 ZFC1121DX
description	pump inlet ø 28mm outlet ø 26mm type ZFC1121DX 230V 50Hz 1 phase 0,25kW L 198mm rotation direction left capacitor 6,3µF LGB		
spare parts for	500979		
	GEV No.	365012	Ref. No. —
	operating capacitor capacity 6,3µF 450V		
	GEV No.	510703	Ref. No. 1001R 1058R N/A
	mechanical shaft seal for shaft ø 13 mm		
	GEV No.	521098	Ref. No. 1649R
	pump cover LGB inlet ø 28 mm outlet ø 26 mm		



1			
GEV No.	500510	Ref. No.	EPR1106 EPR1106A ZF170SX
description	pump inlet ø 28mm outlet ø 26mm type ZF170SX 230V 50Hz 1 phase 0,3kW 0,41HP L 195mm rotation direction right capacitor 6,3µF LGB		
spare parts for	500510		
	GEV No.	365012	Ref. No. —
	operating capacitor capacity 6,3µF 450V		
	GEV No.	510703	Ref. No. 1001R 1058R N/A
	mechanical shaft seal for shaft ø 13 mm		



Table continues overleaf



Зип Общепит

vsezip.ru

+7(812)987-08-81

spare parts for 500979			
	GEV No.	521099	Ref. No. 1580-1R
impellor ø 72 mm H 17 mm thread M7R shaft ø 13 mm			
	GEV No.	528800	Ref. No. 0042R
O-ring EPDM thickness 2,62 mm ID ø 75,87 mm			



1			
GEV No.	500567	Ref. No.	EPR1626 ZF121DX
description	pump inlet ø 28mm outlet ø 28mm type ZF121DX 230V 50Hz 1 phase 0,25kW L 195mm rotation direction left capacitor 6,3µF LGB		
spare parts for 500567			
	GEV No.	365012	Ref. No. —
operating capacitor capacity 6,3µF 450V			
	GEV No.	510703	Ref. No. 1001R 1058R N/A
mechanical shaft seal for shaft ø 13 mm			
	GEV No.	521098	Ref. No. 1649R
pump cover LGB inlet ø 28 mm outlet ø 26 mm			
	GEV No.	521099	Ref. No. 1580-1R
impellor ø 72 mm H 17 mm thread M7R shaft ø 13 mm			
	GEV No.	528800	Ref. No. 0042R
O-ring EPDM thickness 2,62 mm ID ø 75,87 mm			



1			
GEV No.	500483	Ref. No.	ZF121DX
description	pump inlet ø 28mm outlet ø 28mm type ZF121DX 230V 50Hz 1 phase 0,28kW 0,38HP L 195mm rotation direction left capacitor 6,3µF LGB		
spare parts for 500483			
	GEV No.	365012	Ref. No. —
operating capacitor capacity 6,3µF 450V			



1			
GEV No.	500480	Ref. No.	EPR2380 ZF131DX
description	pump inlet ø 28mm outlet ø 28mm type ZF131DX 230V 50Hz 1 phase 0,29kW 0,4HP L 195mm rotation direction left capacitor 6,3µF LGB		
spare parts for 500480			
	GEV No.	365012	Ref. No. —
operating capacitor capacity 6,3µF 450V			
	GEV No.	510690	Ref. No. N/A
mechanical shaft seal for shaft ø 8 mm ED ø 24 mm			
	GEV No.	521083	Ref. No. 0815R
impellor ø 73 mm H 13 mm thread M7R blades 3			
	GEV No.	521084	Ref. No. 1263R
pump cover LGB inlet ø 28 mm outlet ø 25 mm			
	GEV No.	528800	Ref. No. 0042R
O-ring EPDM thickness 2,62 mm ID ø 75,87 mm			

Зип-Обслужител

vsezip.ru

+7(812)987-08-81

electric components



1			
GEV No.	500466	Ref. No.	EPR1722 ZFC1121DX
description	pump inlet \varnothing 28mm outlet \varnothing 28mm type ZFC1121DX 230V 50Hz 1 phase 0,35kW 0,47HP L 200mm rotation direction left capacitor 6,3 μ F LGB		
spare parts for	500466		
	GEV No.	365012	Ref. No. —
	operating capacitor capacity 6,3 μ F 450V		
	GEV No.	510703	Ref. No. 1001R 1058R N/A
	mechanical shaft seal for shaft \varnothing 13 mm		
	GEV No.	521007	Ref. No. 1774R
	pump cover LGB inlet \varnothing 28 mm outlet \varnothing 26 mm		
	GEV No.	521008	Ref. No. 0109-1R
	impellor \varnothing 72 mm H 22 mm rotation direction left		
	GEV No.	528800	Ref. No. 0042R
	O-ring EPDM thickness 2,62 mm ID \varnothing 75,87 mm		



1			
GEV No.	500966	Ref. No.	EPR2111 FC2006
description	pump inlet \varnothing 29mm outlet \varnothing 31/38mm type FC2006 230V 50Hz 1 phase 0,7kW 0,95HP L 195mm rotation direction left capacitor 16 μ F LGB		
spare parts for	500966		
	GEV No.	365021	Ref. No. —
	operating capacitor capacity 16 μ F 425V		

spare parts for 500966			
	GEV No.	510703	Ref. No. 1001R 1058R N/A
	mechanical shaft seal for shaft \varnothing 13 mm		
	GEV No.	521149	Ref. No. N/A
	pump cover LGB outlet \varnothing 33/31mm		
	GEV No.	521150	Ref. No. N/A
	impellor \varnothing 85 mm H 17 mm thread M8R shaft \varnothing 13 mm		
	GEV No.	532537	Ref. No. N/A
	O-ring EPDM thickness 3,53 mm ID \varnothing 113,9 mm		



1			
GEV No.	500351	Ref. No.	X5SX 130994
description	pump inlet \varnothing 29mm outlet \varnothing 39mm type X5SX 230V 50Hz 1 phase 0,8kW 1,09HP L 210mm rotation direction right capacitor 16 μ F LGB		
spare parts for	500351		
	GEV No.	365021	Ref. No. —
	operating capacitor capacity 16 μ F 425V		
	GEV No.	510703	Ref. No. 1001R 1058R N/A
	mechanical shaft seal for shaft \varnothing 13 mm		
	GEV No.	518294	Ref. No. —
	flat gasket rubber D1 \varnothing 85mm D2 \varnothing 71mm		
	GEV No.	521234	Ref. No. N/A
	impellor thread M8L ED \varnothing 93 mm W 16 mm		
	GEV No.	523509	Ref. No. —
	deep-groove ball bearing type 6201-2RS		
	GEV No.	532537	Ref. No. N/A
	O-ring EPDM thickness 3,53 mm ID \varnothing 113,9 mm		

Зип Общепит

vsezip.ru

+7(812)987-08-81



1			
GEV No.	500459	Ref. No.	ZF110SX
description	pump inlet \varnothing 30mm outlet \varnothing 29mm type ZF110SX 230V 50Hz 1 phase 0,25kW 0,34HP L 150mm rotation direction left capacitor 8 μ F LGB		



1			
GEV No.	500511	Ref. No.	EPR1453 ZF140SX
description	pump inlet \varnothing 30mm outlet \varnothing 29mm type ZF140SX 230V 50Hz 1 phase 0,36kW 0,5HP L 190mm rotation direction right LGB		

spare parts for	500511		
	GEV No.	365017	Ref. No. —
	operating capacitor capacity 5 μ F 450V		
	GEV No.	510703	Ref. No. 1001R 1058R N/A
	mechanical shaft seal for shaft \varnothing 13 mm		
	GEV No.	521230	Ref. No. N/A
	impellor \varnothing 86 mm H 16 mm M7L		
	GEV No.	521526	Ref. No. 0009R 3286R
	pump cover LGB inlet \varnothing 30 mm outlet \varnothing 30 mm		
image not available	GEV No.	521706	Ref. No. 2234R
	pump cover gasket		



1			
GEV No.	499104	Ref. No.	EPR1598 ZF135SX
description	pump inlet \varnothing 30mm outlet \varnothing 30mm type ZF135 SX 230V 50Hz 1 phase 0,37kW L 210mm rotation direction right capacitor 8 μ F LGB		

spare parts for	499104		
	GEV No.	365013	Ref. No. —
	operating capacitor capacity 8 μ F 400V		
	GEV No.	510703	Ref. No. 1001R 1058R N/A
	mechanical shaft seal for shaft \varnothing 13 mm		
	GEV No.	521527	Ref. No. 0645R
	pump cover LGB inlet \varnothing 30 mm outlet \varnothing 30 mm		
	GEV No.	521701	Ref. No. 0044R
	pump cover gasket		



1			
GEV No.	500538	Ref. No.	EPR0492 ZF150SX
description	pump inlet \varnothing 30mm outlet \varnothing 30mm type ZF150SX 230V 50Hz 1 phase 0,2kW 0,25HP L 170mm rotation direction right capacitor 10 μ F LGB		



spare parts for	500538		
	GEV No.	365015	Ref. No. —
	operating capacitor capacity 10 μ F 400V		
	GEV No.	510703	Ref. No. 1001R 1058R N/A
	mechanical shaft seal for shaft \varnothing 13 mm		
	GEV No.	521527	Ref. No. 0645R
	pump cover LGB inlet \varnothing 30 mm outlet \varnothing 30 mm		

Table continues overleaf

Зип Общепит





vsezip.ru

+7(812)987-08-81

spare parts for 500538			
	GEV No.	521701	Ref. No. 0044R
	pump cover gasket		
	GEV No.	521707	Ref. No. —
	pump cover gasket		



GEV No.	500384	Ref. No.	EPR0548 ZF160SX
description	pump inlet ø 30mm outlet ø 30mm type ZF160SX 230V 50Hz 1 phase 0,41kW 0,55HP L 180mm rotation direction right capacitor 12,5µF LGB		





spare parts for 500384			
	GEV No.	365014	Ref. No. —
	operating capacitor capacity 12,5µF 400V		
	GEV No.	510703	Ref. No. 1001R 1058R N/A
	mechanical shaft seal for shaft ø 13 mm		
	GEV No.	521527	Ref. No. 0645R
	pump cover LGB inlet ø 30 mm outlet ø 30 mm		
	GEV No.	521701	Ref. No. 0044R
	pump cover gasket		
	GEV No.	521707	Ref. No. —
	pump cover gasket		



GEV No.	499078	Ref. No.	ZF160SX
description	pump inlet ø 30mm outlet ø 30mm type ZF160SX 230V 50Hz 1 phase 0,4kW 0,54HP L 186mm rotation direction right capacitor 12µF LGB		



GEV No.	500461	Ref. No.	EPR0524 ZF210SX
description	pump inlet ø 32mm outlet ø 32mm type ZF210SX 230V 50Hz 1 phase 0,6kW 0,8HP L 180mm capacitor 12,5µF LGB		

spare parts for 500461			
	GEV No.	365014	Ref. No. —
	operating capacitor capacity 12,5µF 400V		
	GEV No.	502267	Ref. No. 0935-1R
	pump cover		
	GEV No.	510702	Ref. No. N/A
	mechanical shaft seal height counter ring 5,5 mm		
	GEV No.	521042	Ref. No. 0116R Girante Pompa EPR0524(Z- F210SX)
	impellor ø 103 mm H 14 mm pump type ZF210SX		
image not available	GEV No.	532719	Ref. No. N/A
	O-ring EPDM thickness 2,62mm ID ø 126,67mm		



Зип Общепит

vsezip.ru

+7(812)987-08-81









1

GEV No.	499138	Ref. No.	1826 X3SX
description	pump inlet \varnothing 33mm outlet \varnothing 26mm type X3SX 230V 50Hz 1 phase 0,26kW L 300mm rotation direction right capacitor 6,3 μ F LGB		
spare parts for	499138		
	GEV No.	365012	Ref. No. —
	operating capacitor capacity 6,3 μ F 450V		
	GEV No.	509004	Ref. No. 0951R
	impellor \varnothing 71 mm H 16 mm M7L		
	GEV No.	510703	Ref. No. 1001R 1058R N/A
	mechanical shaft seal for shaft \varnothing 13 mm		
	GEV No.	521088	Ref. No. N/A
	pump cover LGB inlet \varnothing 33 mm outlet \varnothing 26 mm		
	GEV No.	521147	Ref. No. —
	flange		
	GEV No.	521703	Ref. No. N/A
	pump cover gasket EPDM thickness 2,5 mm ID \varnothing 75 mm		
	GEV No.	523501	Ref. No. —
	deep-groove ball bearing type 608-2RS shaft \varnothing 8mm		



1

GEV No.	499100	Ref. No.	EPR2248 Kundenschutz LA50 130982 LA50 2248
description	pump inlet \varnothing 42mm outlet \varnothing 24/37mm type LA50 230V 50Hz 1 phase 0,47kW L 220mm rotation direction right capacitor 10 μ F LGB with flange and hoses		
spare parts for	499100		
	GEV No.	365015	Ref. No. —
	operating capacitor capacity 10 μ F 400V		
	GEV No.	510702	Ref. No. N/A
	mechanical shaft seal height counter ring 5,5 mm		
	GEV No.	521024	Ref. No. N/A
	impellor \varnothing 88 mm H 30 mm rotation direction right		
	GEV No.	698767	Ref. No. —
	fan blade \varnothing 110mm H 18mm shaft intake \varnothing 12mm		
	GEV No.	698768	Ref. No. N/A
	pump cover LGB inlet \varnothing 42 mm pump type LA50 AP		
	GEV No.	698810	Ref. No. N/A
	O-ring EPDM thickness 3,56mm ID \varnothing 112mm Qty 1 pcs		
	GEV No.	698827	Ref. No. N/A
	threaded ring LGB pump type LA50 \varnothing 120 mm		

Зип Общепит

vsezip.ru

+7(812)987-08-81



GEV No.	499190	Ref. No.	EPR2432 LA50 LA50 2432 LA50 69120
description	pump inlet ø 42mm outlet ø 24/37mm type LA50 230V 50Hz 1 phase 0,47kW L 225mm rotation direction right capacitor 10µF LGB		
spare parts for	499190		
	GEV No.	365015	Ref. No. —
	operating capacitor capacity 10µF 400V		
	GEV No.	510702	Ref. No. N/A
	mechanical shaft seal height counter ring 5,5 mm		
	GEV No.	521024	Ref. No. N/A
	impellor ø 88 mm H 30 mm rotation direction right		
	GEV No.	698767	Ref. No. —
	fan blade ø 110mm H 18mm shaft intake ø 12mm		
	GEV No.	698768	Ref. No. N/A
	pump cover LGB inlet ø 42 mm pump type LA50 AP		
	GEV No.	698793	Ref. No. —
	pump cover outlet ø 24/36mm pump type LGB		
	GEV No.	698810	Ref. No. N/A
	O-ring EPDM thickness 3,56mm ID ø 112mm Qty 1 pcs		
	GEV No.	698827	Ref. No. N/A
	threaded ring LGB pump type LA50 ø 120 mm		

GEV No.	499342	Ref. No.	LA50 74122
description	pump inlet ø 42mm outlet ø 24/37mm type LA50 230V 50Hz 1 phase 0,47kW L 225mm rotation direction right capacitor 10µF LGB		
spare parts for	499342		
	GEV No.	365015	Ref. No. —
	operating capacitor capacity 10µF 400V		
	GEV No.	510702	Ref. No. N/A
	mechanical shaft seal height counter ring 5,5 mm		
	GEV No.	521024	Ref. No. N/A
	impellor ø 88 mm H 30 mm rotation direction right		
	GEV No.	698767	Ref. No. —
	fan blade ø 110mm H 18mm shaft intake ø 12mm		
	GEV No.	698768	Ref. No. N/A
	pump cover LGB inlet ø 42 mm pump type LA50 AP		
	GEV No.	698769	Ref. No. —
	pump casing ø 125mm outlet ø 24/37mm		
	GEV No.	698810	Ref. No. N/A
	O-ring EPDM thickness 3,56mm ID ø 112mm Qty 1 pcs		
	GEV No.	698827	Ref. No. N/A
	threaded ring LGB pump type LA50 ø 120 mm		





Зип Общепит

vsezip.ru

+7(812)987-08-81











1

GEV No.	501484	Ref. No.	LA50
description	pump inlet \varnothing 42mm outlet \varnothing 37/24mm type LA50 230V 50Hz 1 phase 0,47kW L 220mm rotation direction right capacitor 10 μ F auxiliary pressure connection 8mm LGB		
spare parts for	501484		
	GEV No.	365015	Ref. No. —
	operating capacitor capacity 10 μ F 400V		
	GEV No.	510702	Ref. No. N/A
	mechanical shaft seal height counter ring 5,5 mm		
	GEV No.	521024	Ref. No. N/A
	impellor \varnothing 88 mm H 30 mm rotation direction right		
	GEV No.	698767	Ref. No. —
	fan blade \varnothing 110mm H 18mm shaft intake \varnothing 12mm		
	GEV No.	698768	Ref. No. N/A
	pump cover LGB inlet \varnothing 42 mm pump type LA50 AP		
	GEV No.	698769	Ref. No. —
	pump casing \varnothing 125mm outlet \varnothing 24/37mm		
	GEV No.	698810	Ref. No. N/A
	O-ring EPDM thickness 3,56mm ID \varnothing 112mm Qty 1 pcs		
	GEV No.	698827	Ref. No. N/A
	threaded ring LGB pump type LA50 \varnothing 120 mm		



1

GEV No.	501486	Ref. No.	Kundenschutz LA50AP
description	pump inlet \varnothing 42mm outlet \varnothing 37mm type LA50 AP 230V 50Hz 1 phase 0,7kW L 220mm rotation direction right capacitor 14 μ F auxiliary pressure connection 8mm LGB		
spare parts for	501486		
	GEV No.	365020	Ref. No. —
	operating capacitor capacity 14 μ F 400V		
	GEV No.	510702	Ref. No. N/A
	mechanical shaft seal height counter ring 5,5 mm		
	GEV No.	521024	Ref. No. N/A
	impellor \varnothing 88 mm H 30 mm rotation direction right		
	GEV No.	698767	Ref. No. —
	fan blade \varnothing 110mm H 18mm shaft intake \varnothing 12mm		
	GEV No.	698768	Ref. No. N/A
	pump cover LGB inlet \varnothing 42 mm pump type LA50 AP		
	GEV No.	698793	Ref. No. —
	pump cover outlet \varnothing 24/36mm pump type LGB		
	GEV No.	698810	Ref. No. N/A
	O-ring EPDM thickness 3,56mm ID \varnothing 112mm Qty 1 pcs		
	GEV No.	698827	Ref. No. N/A
	threaded ring LGB pump type LA50 \varnothing 120 mm		

Зип Общепит

vsezip.ru

+7(812)987-08-81



1

GEV No.	501485	Ref. No.	CF3265 LA500
description	pump inlet ø 42mm outlet ø 37mm type LA500 230V 50Hz 1 phase 0,47kW L 220mm rotation direction right capacitor 10µF auxiliary pressure connection 8mm LGB		
spare parts for	501485		
	GEV No.	365015	Ref. No. —
	operating capacitor capacity 10µF 400V		
	GEV No.	510702	Ref. No. N/A
	mechanical shaft seal height counter ring 5,5 mm		
	GEV No.	521024	Ref. No. N/A
	impellor ø 88 mm H 30 mm rotation direction right		
	GEV No.	698767	Ref. No. —
	fan blade ø 110mm H 18mm shaft intake ø 12mm		
	GEV No.	698768	Ref. No. N/A
	pump cover LGB inlet ø 42 mm pump type LA50 AP		
	GEV No.	698769	Ref. No. —
	pump casing ø 125mm outlet ø 24/37mm		
	GEV No.	698810	Ref. No. N/A
	O-ring EPDM thickness 3,56mm ID ø 112mm Qty 1 pcs		
	GEV No.	698827	Ref. No. N/A
	threaded ring LGB pump type LA50 ø 120 mm		



1

GEV No.	501528	Ref. No.	CF3192 LA500 60HZ
description	pump inlet ø 42mm outlet ø 37mm type LA500 230V 60Hz 1 phase 0,46kW L 220mm rotation direction right capacitor 10µF auxiliary pressure connection 8mm LGB		
spare parts for	501528		
	GEV No.	365015	Ref. No. —
	operating capacitor capacity 10µF 400V		
	GEV No.	510702	Ref. No. N/A
	mechanical shaft seal height counter ring 5,5 mm		
	GEV No.	521024	Ref. No. N/A
	impellor ø 88 mm H 30 mm rotation direction right		
	GEV No.	698767	Ref. No. —
	fan blade ø 110mm H 18mm shaft intake ø 12mm		
	GEV No.	698768	Ref. No. N/A
	pump cover LGB inlet ø 42 mm pump type LA50 AP		
	GEV No.	698769	Ref. No. —
	pump casing ø 125mm outlet ø 24/37mm		
	GEV No.	698810	Ref. No. N/A
	O-ring EPDM thickness 3,56mm ID ø 112mm Qty 1 pcs		
	GEV No.	698827	Ref. No. N/A
	threaded ring LGB pump type LA50 ø 120 mm		

Зип Общепит

vsezip.ru

+7(812)987-08-81



GEV No.	499084	Ref. No.	ZF340VSX
description	pump inlet ø 44mm outlet ø 39mm type ZF340VSX 220-240V 50Hz 1 phase 0,7kW L 245mm rotation direction right capacitor 16µF LGB HOONVED		



GEV No.	500553	Ref. No.	EPR2008 ZF290SX
description	pump inlet ø 45mm outlet ø 38mm type ZF290SX 230V 50Hz 1 phase 0,65kW 0,88HP L 200mm rotation direction right capacitor 12,5µF auxiliary pressure connection 13mm supporting pressure open LGB		
spare parts for	500553		
	GEV No.	365014	Ref. No. —
	operating capacitor capacity 12,5µF 400V		
	GEV No.	510702	Ref. No. N/A
	mechanical shaft seal height counter ring 5,5 mm		
	GEV No.	521106	Ref. No. 0114-1R
	impellor ø 97 mm H 24 mm rotation direction right		
	GEV No.	521542	Ref. No. 0878R
	pump cover LGB inlet ø 45 mm outlet ø 40 mm		
	GEV No.	521714	Ref. No. 0046R 3283R
	pump cover gasket thickness 4x4mm Qty 1 pcs		



GEV No.	499154	Ref. No.	EPR 1986 ZF320SX
description	pump inlet ø 45mm outlet ø 38mm type ZF320SX 230V 50Hz 1 phase 0,55kW 0,75HP L 205mm rotation direction right capacitor 12,5µF LGB		
spare parts for	499154		
	GEV No.	365014	Ref. No. —
	operating capacitor capacity 12,5µF 400V		
	GEV No.	510702	Ref. No. N/A
	mechanical shaft seal height counter ring 5,5 mm		
	GEV No.	521247	Ref. No. N/A
	impellor ø 90 mm H 27 mm rotation direction right		
	GEV No.	521542	Ref. No. 0878R
	pump cover LGB inlet ø 45 mm outlet ø 40 mm		
	GEV No.	521714	Ref. No. 0046R 3283R
	pump cover gasket thickness 4x4mm Qty 1 pcs		



GEV No.	500508	Ref. No.	EPR1204 ZF320VSX
description	pump inlet ø 45mm outlet ø 38mm type ZF320VSX 230V 50Hz 1 phase 0,75kW 1HP L 230mm rotation direction right capacitor 12,5µF LGB		
spare parts for	500508		
	GEV No.	365014	Ref. No. —
	operating capacitor capacity 12,5µF 400V		

Table continues overleaf

Зип Общепит

vsezip.ru

+7(812)987-08-81

spare parts for 500508			
	GEV No.	510702	Ref. No. N/A
mechanical shaft seal height counter ring 5,5 mm			
	GEV No.	521247	Ref. No. N/A
impellor ø 90 mm H 27 mm rotation direction right			
	GEV No.	521542	Ref. No. 0878R
pump cover LGB inlet ø 45 mm outlet ø 40 mm			
	GEV No.	521714	Ref. No. 0046R 3283R
pump cover gasket thickness 4x4mm Qty 1 pcs			



1			
GEV No.	499074	Ref. No.	EPR2906 ZF340SX
description pump inlet ø 45mm outlet ø 38mm type ZF340SX 230V 50Hz 1 phase 0,7kW 0,95HP L 215mm rotation direction right capacitor 16µF auxiliary pressure connection 13mm LGB			
spare parts for 499074			
	GEV No.	365021	Ref. No. —
operating capacitor capacity 16µF 425V			
	GEV No.	510702	Ref. No. N/A
mechanical shaft seal height counter ring 5,5 mm			
	GEV No.	521246	Ref. No. 0591-1R
impellor ø 103 mm H 26 mm thread M8L shaft ø 20 mm			
	GEV No.	521542	Ref. No. 0878R
pump cover LGB inlet ø 45 mm outlet ø 40 mm			
	GEV No.	521714	Ref. No. 0046R 3283R
pump cover gasket thickness 4x4mm Qty 1 pcs			



1			
GEV No.	500586	Ref. No.	EPR1043 FM4023SX
description pump inlet ø 45mm outlet ø 39mm type FM4023SX 230V 50Hz 1 phase 0,8kW 1,09HP L 297mm rotation direction right capacitor 16µF LGB			
spare parts for 500586			
	GEV No.	365021	Ref. No. —
operating capacitor capacity 16µF 425V			
	GEV No.	510703	Ref. No. 1001R 1058R N/A
mechanical shaft seal for shaft ø 13 mm			
	GEV No.	521246	Ref. No. 0591-1R
impellor ø 103 mm H 26 mm thread M8L shaft ø 20 mm			
	GEV No.	521542	Ref. No. 0878R
pump cover LGB inlet ø 45 mm outlet ø 40 mm			
	GEV No.	521714	Ref. No. 0046R 3283R
pump cover gasket thickness 4x4mm Qty 1 pcs			



1			
GEV No.	500984	Ref. No.	EPR1760 ZF270VSX 230/50/1
description pump inlet ø 45mm outlet ø 39mm type ZF270VSX 230V 50Hz 1 phase 0,4kW L 209mm rotation direction right capacitor 10µF LGB			



Зип Общепит

vsezip.ru

+7(812)987-08-81



1





GEV No.	500157	Ref. No.	ZF320SX (Hoonved 31154)
description	pump inlet \varnothing 45mm outlet \varnothing 39mm type ZF320SX 230V 50Hz 1 phase 0,75kW 1HP L 200mm rotation direction right capacitor 12 μ F LGB		



1



GEV No.	500398	Ref. No.	EPR0759 ZF320VSX
description	pump inlet \varnothing 45mm outlet \varnothing 39mm type ZF320VSX 230V 50Hz 1 phase 0,6kW 0,82HP L 230mm rotation direction right capacitor 12,5 μ F LGB		

spare parts for 500398

	GEV No.	365014	Ref. No.	—
	operating capacitor capacity 12,5 μ F 400V			
	GEV No.	510702	Ref. No.	N/A
	mechanical shaft seal height counter ring 5,5 mm			
	GEV No.	521247	Ref. No.	N/A
	impellor \varnothing 90 mm H 27 mm rotation direction right			
	GEV No.	521542	Ref. No.	0878R
	pump cover LGB inlet \varnothing 45 mm outlet \varnothing 40 mm			
	GEV No.	521714	Ref. No.	0046R 3283R
	pump cover gasket thickness 4x4mm Qty 1 pcs			



1

GEV No.	500585	Ref. No.	EPR1041 ZF320VSX	
description	pump inlet \varnothing 45mm outlet \varnothing 39mm type ZF320VSX 230V 50Hz 1 phase 0,65kW 0,88HP L 230mm rotation direction right capacitor 12,5 μ F LGB			
spare parts for	500585			
	GEV No.	365014	Ref. No.	—
	operating capacitor capacity 12,5 μ F 400V			
	GEV No.	510702	Ref. No.	N/A
	mechanical shaft seal height counter ring 5,5 mm			
	GEV No.	521106	Ref. No.	0114-1R
	impellor \varnothing 97 mm H 24 mm rotation direction right			
	GEV No.	521542	Ref. No.	0878R
	pump cover LGB inlet \varnothing 45 mm outlet \varnothing 40 mm			
	GEV No.	521714	Ref. No.	0046R 3283R
	pump cover gasket thickness 4x4mm Qty 1 pcs			

Зип Общепит

vsezip.ru

+7(812)987-08-81



1

GEV No.	500513	Ref. No.	0452 EPR0452 EPR0452A FM4023SX
description	pump inlet ø 45mm outlet ø 40mm type FM4023SX 230V 50Hz 1 phase 0,75kW 1HP L 300mm rotation direction right capacitor 16µF LGB		
spare parts for	500513		
	GEV No.	Ref. No.	—
	365021		
	operating capacitor capacity 16µF 425V		
	GEV No.	Ref. No.	1001R 1058R N/A
	510703		
	mechanical shaft seal for shaft ø 13 mm		
	GEV No.	Ref. No.	0591-1R
	521246		
	impellor ø 103 mm H 26 mm thread M8L shaft ø 20 mm		
	GEV No.	Ref. No.	0878R
	521542		
	pump cover LGB inlet ø 45 mm outlet ø 40 mm		
	GEV No.	Ref. No.	0046R 3283R
	521714		
	pump cover gasket thickness 4x4mm Qty 1 pcs		



1

GEV No.	500942	Ref. No.	EPR2372 ZF150SX
description	pump inlet ø 45mm outlet ø 40mm type ZF150SX 230V 50Hz 1 phase 0,34kW 0,5HP L 180mm rotation direction right capacitor 10µF LGB		



1

GEV No.	500937	Ref. No.	EPR2346-1 ZF150SX
description	pump inlet ø 45mm outlet ø 40mm type ZF150SX 230V 50Hz 1 phase 0,36kW 0,48HP L 180mm rotation direction right capacitor 10µF auxiliary pressure connection 13mm supporting pressure open LGB		
spare parts for	500937		
	GEV No.	Ref. No.	—
	365015		
	operating capacitor capacity 10µF 400V		
	GEV No.	Ref. No.	1001R 1058R N/A
	510703		
	mechanical shaft seal for shaft ø 13 mm		
	GEV No.	Ref. No.	0044R
	521701		
	pump cover gasket		



1

GEV No.	500946	Ref. No.	EPR2660 ZF150SX
description	pump inlet ø 45mm outlet ø 40mm type ZF150SX 230V 50Hz 1 phase 0,36kW 0,5HP L 180mm rotation direction right capacitor 10µF LGB		
spare parts for	500946		
	GEV No.	Ref. No.	—
	365015		
	operating capacitor capacity 10µF 400V		
	GEV No.	Ref. No.	1001R 1058R N/A
	510703		
	mechanical shaft seal for shaft ø 13 mm		

Table continues overleaf





Зип Общепит

vsezip.ru

+7(812)987-08-81

spare parts for 500946

	GEV No.	521140	Ref. No.	Chiocciola per Pompa EPR2660/ ZF150SX
pump cover LGB inlet ø 45 mm outlet ø 40 mm				
	GEV No.	521701	Ref. No.	0044R
pump cover gasket				



1





GEV No.	499096	Ref. No.	ZF220SX
description	pump inlet ø 45mm outlet ø 40mm type ZF220SX 230V 50Hz 1 phase 0,69kW L 188mm rotation direction right capacitor 12,5µF LGB		



1

GEV No.	499248	Ref. No.	C.F.2062 ZF220V SX
description	pump inlet ø 45mm outlet ø 40mm type ZF220VSX 230V 50Hz 1 phase 0,85kW L 230mm rotation direction right capacitor 12,5µF LGB		

spare parts for 499248

	GEV No.	365014	Ref. No.	—
operating capacitor capacity 12,5µF 400V				
	GEV No.	510556	Ref. No.	N/A
O-ring EPDM thickness 1,78 mm ID ø 94,97 mm				
	GEV No.	510694	Ref. No.	N/A
mechanical shaft seal for shaft ø 13 mm				
	GEV No.	521112	Ref. No.	N/A
impellor ø 93 mm H 21 mm pump type ZF220VSX				
	GEV No.	521113	Ref. No.	N/A
pump cover LGB inlet ø 45 mm outlet ø 40 mm				







1

GEV No.	500470	Ref. No.	EPR2046 ZF270V DX
---------	--------	----------	-------------------

description	pump inlet ø 45mm outlet ø 40mm type ZF270V DX 230V 50Hz 1 phase 0,6kW 0,8HP L 225mm rotation direction left capacitor 12,5µF LGB		
-------------	---	--	--

spare parts for 500470

	GEV No.	365014	Ref. No.	—
operating capacitor capacity 12,5µF 400V				
	GEV No.	510702	Ref. No.	N/A
mechanical shaft seal height counter ring 5,5 mm				
	GEV No.	521109	Ref. No.	1572R
pump cover LGB inlet ø 45 mm outlet ø 40 mm				
	GEV No.	521111	Ref. No.	1574-1R
impellor ø 105 mm H 29 mm thread M8R shaft ø 20 mm				
	GEV No.	521714	Ref. No.	0046R 3283R
pump cover gasket thickness 4x4mm Qty 1 pcs				

Зип Общепит

vsezip.ru

+7(812)987-08-81



1

GEV No.	500584	Ref. No.	EPR1040 ZF290SX
description	pump inlet ø 45mm outlet ø 40mm type ZF290SX 230V 50Hz 1 phase 0,65kW 0,88HP L 200mm rotation direction right capacitor 12,5µF LGB		
spare parts for	500584		
	GEV No.	365014	Ref. No. —
	operating capacitor capacity 12,5µF 400V		
	GEV No.	510702	Ref. No. N/A
	mechanical shaft seal height counter ring 5,5 mm		
	GEV No.	521106	Ref. No. 0114-1R
	impellor ø 97 mm H 24 mm rotation direction right		
	GEV No.	521542	Ref. No. 0878R
	pump cover LGB inlet ø 45 mm outlet ø 40 mm		
	GEV No.	521714	Ref. No. 0046R 3283R
	pump cover gasket thickness 4x4mm Qty 1 pcs		



1

GEV No.	500120	Ref. No.	EPR0926 ZF320SX
description	pump inlet ø 45mm outlet ø 40mm type ZF320SX 230V 50Hz 1 phase 0,55kW 0,75HP L 200mm rotation direction right capacitor 12,5µF LGB		
spare parts for	500120		
	GEV No.	365014	Ref. No. —
	operating capacitor capacity 12,5µF 400V		
	GEV No.	510702	Ref. No. N/A
	mechanical shaft seal height counter ring 5,5 mm		
	GEV No.	521300	Ref. No. 0697-1R
	impellor ø 94 mm H 27 mm pump type ZF320SX		
	GEV No.	521542	Ref. No. 0878R
	pump cover LGB inlet ø 45 mm outlet ø 40 mm		
	GEV No.	521714	Ref. No. 0046R 3283R
	pump cover gasket thickness 4x4mm Qty 1 pcs		



1

GEV No.	500554	Ref. No.	EPR2030 ZF290SX
description	pump inlet ø 45mm outlet ø 40mm type ZF290SX 230V 50Hz 1 phase 0,67kW 0,8HP L 200mm rotation direction right capacitor 12,5µF LGB		
spare parts for	500554		
	GEV No.	365014	Ref. No. —
	operating capacitor capacity 12,5µF 400V		



1



GEV No.	500919	Ref. No.	EPR0629 ZF320SX
description	pump inlet ø 45mm outlet ø 40mm type ZF320SX 230V 50Hz 1 phase 0,55kW 0,75HP L 200mm rotation direction right capacitor 12µF LGB		

Зип-Общесит

vsezip.ru

+7(812)987-08-81



GEV No.	500121	Ref. No.	EPR0630 ZF320SX
description	pump inlet ø 45mm outlet ø 40mm type ZF320SX 230V 50Hz 1 phase 0,55kW 0,75HP L 220mm rotation direction right capacitor 12,5µF LGB		
spare parts for	500121		
	GEV No.	365014	Ref. No. —
	operating capacitor capacity 12,5µF 400V		
	GEV No.	510702	Ref. No. N/A
	mechanical shaft seal height counter ring 5,5 mm		
	GEV No.	521300	Ref. No. 0697-1R
	impellor ø 94 mm H 27 mm pump type ZF320SX		
	GEV No.	521542	Ref. No. 0878R
	pump cover LGB inlet ø 45 mm outlet ø 40 mm		
	GEV No.	521714	Ref. No. 0046R 3283R
	pump cover gasket thickness 4x4mm Qty 1 pcs		



GEV No.	500355	Ref. No.	EPR1356 ZF320SX
description	pump inlet ø 45mm outlet ø 40mm type ZF320SX 230V 50Hz 1 phase 0,7kW 0,95HP L 200mm rotation direction right capacitor 12,5µF LGB		
spare parts for	500355		
	GEV No.	365014	Ref. No. —
	operating capacitor capacity 12,5µF 400V		

spare parts for	500355		
	GEV No.	510702	Ref. No. N/A
	mechanical shaft seal height counter ring 5,5 mm		
	GEV No.	512404	Ref. No. 0438R
	bracket mounting distance 130mm		
	GEV No.	521246	Ref. No. 0591-1R
	impellor ø 103 mm H 26 mm thread M8L shaft ø 20 mm		
	GEV No.	521542	Ref. No. 0878R
	pump cover LGB inlet ø 45 mm outlet ø 40 mm		
	GEV No.	521714	Ref. No. 0046R 3283R
	pump cover gasket thickness 4x4mm Qty 1 pcs		



GEV No.	500381	Ref. No.	EPR0713 ZF320VSX
description	pump inlet ø 45mm outlet ø 40mm type ZF320VSX 230V 50Hz 1 phase 0,6kW 0,82HP L 230mm rotation direction right capacitor 12,5µF LGB		
spare parts for	500381		
	GEV No.	365014	Ref. No. —
	operating capacitor capacity 12,5µF 400V		
	GEV No.	510702	Ref. No. N/A
	mechanical shaft seal height counter ring 5,5 mm		
	GEV No.	512420	Ref. No. 0437R
	bracket mounting distance 110mm		
	GEV No.	521058	Ref. No. 2899R
	fanwheel cover suitable for LGB ID ø 138mm		
	GEV No.	521247	Ref. No. N/A
	impellor ø 90 mm H 27 mm rotation direction right		
	GEV No.	521542	Ref. No. 0878R
	pump cover LGB inlet ø 45 mm outlet ø 40 mm		
	GEV No.	521714	Ref. No. 0046R 3283R
	pump cover gasket thickness 4x4mm Qty 1 pcs		

Зип-Общественит

vsezip.ru

+7(812)987-08-81



1

GEV No.	500512	Ref. No.	EPR1227 ZF340VSX
description	pump inlet \varnothing 45mm outlet \varnothing 40mm type ZF340VSX 230V 50Hz 1 phase 0,75kW 1HP L 245mm rotation direction right capacitor 16 μ F LGB		
spare parts for	500512		
	GEV No.	Ref. No.	—
	365021		
	operating capacitor capacity 16 μ F 425V		
	GEV No.	Ref. No.	N/A
	510702		
	mechanical shaft seal height counter ring 5,5 mm		
	GEV No.	Ref. No.	0591-1R
	521246		
	impellor \varnothing 103 mm H 26 mm thread M8L shaft \varnothing 20 mm		
	GEV No.	Ref. No.	0878R
	521542		
	pump cover LGB inlet \varnothing 45 mm outlet \varnothing 40 mm		
	GEV No.	Ref. No.	0046R 3283R
	521714		
	pump cover gasket thickness 4x4mm Qty 1 pcs		



1

GEV No.	499135	Ref. No.	EPR2898 ZF350SX
description	pump inlet \varnothing 45mm outlet \varnothing 40mm type ZF350SX 230/400V 50Hz 3 phase 0,61kW L 220mm rotation direction right LGB		
spare parts for	499135		
	GEV No.	Ref. No.	N/A
	510702		
	mechanical shaft seal height counter ring 5,5 mm		

spare parts for 499135			
	GEV No.	Ref. No.	2037R
	521089		
	impellor \varnothing 88 mm H 32 mm thread M8L		
	GEV No.	Ref. No.	0878R
	521542		
	pump cover LGB inlet \varnothing 45 mm outlet \varnothing 40 mm		
	GEV No.	Ref. No.	0046R 3283R
	521714		
	pump cover gasket thickness 4x4mm Qty 1 pcs		



1

GEV No.	499011	Ref. No.	EPR2022 ZF350SX
description	pump inlet \varnothing 50mm outlet \varnothing 40mm type ZF350SX 230V 50Hz 1 phase 0,63kW L 201mm rotation direction right LGB 2800rpm suitable capacitor 12,5 μ F		
spare parts for	499011		
	GEV No.	Ref. No.	—
	365014		
	operating capacitor capacity 12,5 μ F 400V		
	GEV No.	Ref. No.	N/A
	510702		
	mechanical shaft seal height counter ring 5,5 mm		
	GEV No.	Ref. No.	1435R
	521086		
	pump cover LGB inlet \varnothing 50 mm outlet \varnothing 40 mm		
	GEV No.	Ref. No.	2037R
	521278		
	impellor \varnothing 93 mm H 32 mm pump type ZF350SX		
	GEV No.	Ref. No.	0046R 3283R
	521714		
	pump cover gasket thickness 4x4mm Qty 1 pcs		

electric components



Зип Общепит

vsezip.ru

+7(812)987-08-81



GEV No.	500924	Ref. No.	EPR2353-1 ZF350VSX
description	pump inlet ø 50mm outlet ø 40mm type ZF350VSX 440V 60Hz 3 phase 0,75kW 1HP L 230mm rotation direction right LGB		



GEV No.	499058	Ref. No.	EPR2024 ZF380SX
description	pump inlet ø 50mm outlet ø 40mm type ZF380SX 230V 50Hz 1 phase 0,73kW 0,99HP L 210mm rotation direction right capacitor 16µF LGB		

spare parts for	499058		
	GEV No.	Ref. No.	—
	operating capacitor capacity 16µF 425V		
	GEV No.	Ref. No.	N/A
	mechanical shaft seal height counter ring 5,5 mm		
	GEV No.	Ref. No.	1435R
	pump cover LGB inlet ø 50 mm outlet ø 40 mm		
	GEV No.	Ref. No.	2038-1R
	impellor ø 100 mm H 32 mm thread M8L		
	GEV No.	Ref. No.	0046R 3283R
	pump cover gasket thickness 4x4mm Qty 1 pcs		



GEV No.	500092	Ref. No.	W300SX
description	pump inlet ø 50mm outlet ø 44mm type W300SX 230V 50Hz 1 phase 0,3kW 0,5HP L 170mm rotation direction right capacitor 10µF LGB		

spare parts for	500092		
	GEV No.	Ref. No.	—
	operating capacitor capacity 10µF 400V		
	GEV No.	Ref. No.	n/a
	O-ring EPDM thickness 2 mm ID ø 120 mm Qty 1 pcs		
	GEV No.	Ref. No.	N/A
	impellor ø 85 mm H 29 mm shaft intake ø 9x8mm		
	GEV No.	Ref. No.	N/A
	mechanical shaft seal for shaft ø 12 mm		
	GEV No.	Ref. No.	—
	pump cover bottom part		
	GEV No.	Ref. No.	N/A
	pump cover		



GEV No.	500093	Ref. No.	EPR0962 W500SX
description	pump inlet ø 50mm outlet ø 44mm type W500SX 230V 50Hz 1 phase 0,5kW 0,7HP L 200mm rotation direction right capacitor 16µF LGB		



spare parts for	500093		
	GEV No.	Ref. No.	—
	operating capacitor capacity 16µF 425V		
	GEV No.	Ref. No.	N/A
	impellor ø 85 mm H 29 mm shaft intake ø 9x8mm		

Table continues overleaf

Зип Общепит

vsezip.ru

+7(812)987-08-81

spare parts for 500093			
	GEV No.	510693	Ref. No. N/A
	mechanical shaft seal for shaft \varnothing 12 mm		
	GEV No.	521564	Ref. No. N/A
	pump cover		
	GEV No.	521717	Ref. No. N/A
	O-ring EPDM thickness 1,78 mm ID \varnothing 120,37 mm		







1

GEV No.	499306	Ref. No.	ZF650SX (2473 - 9099.ZF650.00)
description	pump inlet \varnothing 50mm outlet \varnothing 48mm type ZF650SX 230V 50Hz 1 phase 1,47kW L 340mm rotation direction right LGB		
spare parts for 499306			
	GEV No.	365019	Ref. No. —
	operating capacitor capacity 20 μ F 400V		
	GEV No.	510551	Ref. No. 0049R
	pump cover gasket ID \varnothing 158,3 mm		
	GEV No.	510694	Ref. No. N/A
	mechanical shaft seal for shaft \varnothing 13 mm		
	GEV No.	521108	Ref. No. 0021R
	pump cover LGB inlet \varnothing 50 mm outlet \varnothing 50 mm		
	GEV No.	521240	Ref. No. 2500R
	impellor \varnothing 110 mm H 32 mm rotation direction left		



1





GEV No.	500156	Ref. No.	EPR0461 ZF400SX
description	pump inlet \varnothing 50mm outlet \varnothing 50mm type ZF400SX 230V 50Hz 1 phase 0,6kW 0,8HP L 210mm rotation direction right capacitor 16 μ F LGB		
spare parts for 500156			
	GEV No.	365021	Ref. No. —
	operating capacitor capacity 16 μ F 425V		
	GEV No.	509020	Ref. No. 1834R
	impellor \varnothing 104 mm H 25 mm M8L		
	GEV No.	510703	Ref. No. 1001R 1058R N/A
	mechanical shaft seal for shaft \varnothing 13 mm		
	GEV No.	521548	Ref. No. 0020R
	pump cover LGB inlet \varnothing 50 mm outlet \varnothing 50 mm		
	GEV No.	521734	Ref. No. —
	pump cover bottom part		
	GEV No.	523509	Ref. No. —
	deep-groove ball bearing type 6201-2RS		
	GEV No.	532623	Ref. No. 1743R
	O-ring EPDM thickness 2,62mm ID \varnothing 120,32mm		

Зиг-Общепит



vsezipt





+7(812)987-08-81







GEV No.	499225	Ref. No.	ZF400VSX
description	pump inlet ø 50mm outlet ø 50mm type ZF400VSX 230V 50Hz 1 phase 0,81kW 1,1HP L 245mm rotation direction right capacitor 16µF C 34 dgt / C 44 dgt LGB		
spare parts for	499225		
	GEV No.	365021	Ref. No. —
	operating capacitor capacity 16µF 425V		
	GEV No.	510703	Ref. No. 1001R 1058R N/A
	mechanical shaft seal for shaft ø 13 mm		
	GEV No.	521090	Ref. No. Girante per Pompa ZF400SX EPR2287
	impellor ø 101 mm H 32 mm thread M8L shaft ø 13 mm		
	GEV No.	521548	Ref. No. 0020R
	pump cover LGB inlet ø 50 mm outlet ø 50 mm		
	GEV No.	532623	Ref. No. 1743R
	O-ring EPDM thickness 2,62mm ID ø 120,32mm		



GEV No.	500543	Ref. No.	EPR0634 ZF400VSX
description	pump inlet ø 50mm outlet ø 50mm type ZF400VSX 230V 50Hz 1 phase 0,85kW 1,2HP L 245mm rotation direction right capacitor 16µF LGB		
spare parts for	500543		
	GEV No.	365021	Ref. No. —
	operating capacitor capacity 16µF 425V		
	GEV No.	509020	Ref. No. 1834R
	impellor ø 104 mm H 25 mm M8L		

spare parts for	500543		
	GEV No.	510703	Ref. No. 1001R 1058R N/A
	mechanical shaft seal for shaft ø 13 mm		
	GEV No.	521548	Ref. No. 0020R
	pump cover LGB inlet ø 50 mm outlet ø 50 mm		
	GEV No.	521734	Ref. No. —
	pump cover bottom part		
	GEV No.	532623	Ref. No. 1743R
	O-ring EPDM thickness 2,62mm ID ø 120,32mm		



GEV No.	500361	Ref. No.	EPR1230 ZF400SX
description	pump inlet ø 60mm outlet ø 49mm type ZF400SX 230V 50Hz 1 phase 0,8kW 1HP L 210mm rotation direction right capacitor 16µF LGB		
spare parts for	500361		
	GEV No.	365021	Ref. No. —
	operating capacitor capacity 16µF 425V		
	GEV No.	509020	Ref. No. 1834R
	impellor ø 104 mm H 25 mm M8L		
	GEV No.	510703	Ref. No. 1001R 1058R N/A
	mechanical shaft seal for shaft ø 13 mm		
	GEV No.	521547	Ref. No. 0758R 0758R (blu)
	pump cover LGB inlet ø 60 mm outlet ø 50 mm		
	GEV No.	532623	Ref. No. 1743R
	O-ring EPDM thickness 2,62mm ID ø 120,32mm		





Зип Обществу

vsezip.ru

+7(812)987-08-81







1

GEV No.	501527	Ref. No.	CF2420 ZF400SX 60HZ
description	pump inlet ø 60mm outlet ø 49mm type ZF400SX 230V 60Hz 1 phase 0,77kW 1HP L 210mm rotation direction right capacitor 16µF LGB		
spare parts for	501527		
	GEV No.	365021	Ref. No. —
	operating capacitor capacity 16µF 425V		
	GEV No.	509020	Ref. No. 1834R
	impellor ø 104 mm H 25 mm M8L		
	GEV No.	510703	Ref. No. 1001R 1058R N/A
	mechanical shaft seal for shaft ø 13 mm		
	GEV No.	521547	Ref. No. 0758R 0758R (blu)
	pump cover LGB inlet ø 60 mm outlet ø 50 mm		
	GEV No.	532623	Ref. No. 1743R
	O-ring EPDM thickness 2,62mm ID ø 120,32mm		







1

GEV No.	499282	Ref. No.	2196 ZF400VSX
description	pump inlet ø 60mm outlet ø 49mm type ZF400VSX 220-230/380-400V 50Hz 3 phase 0,7kW L 270mm rotation direction right LGB		
spare parts for	499282		
	GEV No.	502279	Ref. No. 2038R
	impellor H 31 mm ED ø 100 mm blades 6		
	GEV No.	510702	Ref. No. N/A
	mechanical shaft seal height counter ring 5,5 mm		
	GEV No.	521058	Ref. No. 2899R
	fanwheel cover suitable for LGB ID ø 138mm		

spare parts for 499282			
	GEV No.	521547	Ref. No. 0758R 0758R (blu)
	pump cover LGB inlet ø 60 mm outlet ø 50 mm		
	GEV No.	532623	Ref. No. 1743R
	O-ring EPDM thickness 2,62mm ID ø 120,32mm		



1

GEV No.	499114	Ref. No.	EPR1831
description	pump inlet ø 60mm outlet ø 50mm 220-240V 50Hz 1 phase 0,7kW L 245mm rotation direction right capacitor 16µF		
spare parts for	499114		
	GEV No.	365021	Ref. No. —
	operating capacitor capacity 16µF 425V		
	GEV No.	509020	Ref. No. 1834R
	impellor ø 104 mm H 25 mm M8L		
	GEV No.	510703	Ref. No. 1001R 1058R N/A
	mechanical shaft seal for shaft ø 13 mm		
image not available	GEV No.	521049	Ref. No. —
	service kit for pump type ZF400VSX LGB		
	GEV No.	521547	Ref. No. 0758R 0758R (blu)
	pump cover LGB inlet ø 60 mm outlet ø 50 mm		
	GEV No.	532623	Ref. No. 1743R
	O-ring EPDM thickness 2,62mm ID ø 120,32mm		





Зиг-Общепит

vsezip.ru

+7(812)987-08-81







1

GEV No.	500001	Ref. No.	EPR1638 T150SX
description	pump inlet ø 60mm outlet ø 50mm type T150SX 230/400V 50Hz 3 phase 0,9kW 1,2HP L 290mm rotation direction right LGB		
spare parts for	500001		
	GEV No.	509020	Ref. No. 1834R
	impellor ø 104 mm H 25 mm M8L		
	GEV No.	510703	Ref. No. 1001R 1058R N/A
	mechanical shaft seal for shaft ø 13 mm		
	GEV No.	521547	Ref. No. 0758R 0758R (blu)
	pump cover LGB inlet ø 60 mm outlet ø 50 mm		
	GEV No.	532623	Ref. No. 1743R
	O-ring EPDM thickness 2,62mm ID ø 120,32mm		







1

GEV No.	500091	Ref. No.	EPR0464 ZA160SX
description	pump inlet ø 60mm outlet ø 50mm type ZA160SX 230/400V 50Hz 3 phase 1,1kW 1,5HP L 310mm rotation direction right LGB		
spare parts for	500091		
	GEV No.	510554	Ref. No. n/a
	O-ring EPDM thickness 2 mm ID ø 120 mm Qty 1 pcs		
	GEV No.	510616	Ref. No. 0123R
	impellor ø 104 mm H 25 mm shaft intake ø 10 mm		

spare parts for	500091		
	GEV No.	510703	Ref. No. 1001R 1058R N/A
	mechanical shaft seal for shaft ø 13 mm		
	GEV No.	521547	Ref. No. 0758R 0758R (blu)
	pump cover LGB inlet ø 60 mm outlet ø 50 mm		



1

GEV No.	500148	Ref. No.	EPR0650 ZA160SX
description	pump inlet ø 60mm outlet ø 50mm type ZA160SX 230V 50Hz 1 phase 1,1kW 1,5HP L 310mm rotation direction right capacitor 25µF LGB		
spare parts for	500148		
	GEV No.	365109	Ref. No. —
	operating capacitor capacity 25µF 400V		
	GEV No.	510616	Ref. No. 0123R
	impellor ø 104 mm H 25 mm shaft intake ø 10 mm		
	GEV No.	510703	Ref. No. 1001R 1058R N/A
	mechanical shaft seal for shaft ø 13 mm		
	GEV No.	521547	Ref. No. 0758R 0758R (blu)
	pump cover LGB inlet ø 60 mm outlet ø 50 mm		
	GEV No.	532623	Ref. No. 1743R
	O-ring EPDM thickness 2,62mm ID ø 120,32mm		

Зип Общедит

vsezip.ru

+7(812)987-08-81

electric components



GEV No.	500002	Ref. No.	EPR0460A ZA400SX
description	pump inlet ø 60mm outlet ø 50mm type ZA400SX 230V 50Hz 1 phase 0,9kW 1,2HP L 300mm rotation direction right capacitor 20µF LGB		
spare parts for	500002		
	GEV No.	Ref. No.	—
	365019		
	operating capacitor capacity 20µF 400V		
	GEV No.	Ref. No.	1834R
	509020		
	impellor ø 104 mm H 25 mm M8L		
	GEV No.	Ref. No.	1001R 1058R N/A
	510703		
	mechanical shaft seal for shaft ø 13 mm		
	GEV No.	Ref. No.	0758R 0758R (blu)
	521547		
	pump cover LGB inlet ø 60 mm outlet ø 50 mm		
	GEV No.	Ref. No.	1743R
	532623		
	O-ring EPDM thickness 2,62mm ID ø 120,32mm		



GEV No.	500474	Ref. No.	EPR1622 ZF400SX
description	pump inlet ø 60mm outlet ø 50mm type ZF400SX 230V 50Hz 1 phase 0,7kW 0,95HP L 215mm rotation direction right capacitor 16µF LGB		
spare parts for	500474		
	GEV No.	Ref. No.	—
	365021		
	operating capacitor capacity 16µF 425V		

spare parts for	500474		
	GEV No.	Ref. No.	1834R
	509020		
	impellor ø 104 mm H 25 mm M8L		
	GEV No.	Ref. No.	1001R 1058R N/A
	510703		
	mechanical shaft seal for shaft ø 13 mm		
	GEV No.	Ref. No.	0758R 0758R (blu)
	521547		
	pump cover LGB inlet ø 60 mm outlet ø 50 mm		
	GEV No.	Ref. No.	1743R
	532623		
	O-ring EPDM thickness 2,62mm ID ø 120,32mm		



GEV No.	499126	Ref. No.	EPR2287 ZF400SX
description	pump inlet ø 60mm outlet ø 50mm type ZF400SX 230V 50Hz 1 phase 1,1kW L 215mm rotation direction right capacitor 16µF LGB		
spare parts for	499126		
	GEV No.	Ref. No.	—
	365021		
	operating capacitor capacity 16µF 425V		
	GEV No.	Ref. No.	1001R 1058R N/A
	510703		
	mechanical shaft seal for shaft ø 13 mm		
	GEV No.	Ref. No.	Girante per Pompa ZF400SX EPR2287
	521090		
	impellor ø 101 mm H 32 mm thread M8L shaft ø 13 mm		
	GEV No.	Ref. No.	0758R 0758R (blu)
	521547		
	pump cover LGB inlet ø 60 mm outlet ø 50 mm		
	GEV No.	Ref. No.	1743R
	532623		
	O-ring EPDM thickness 2,62mm ID ø 120,32mm		



Зип Общепит

vsezip.ru

+7(812)987-08-81



GEV No.	500486	Ref. No.	EPR1623 ZF400SX
description	pump inlet ø 60mm outlet ø 50mm type ZF400VSX 230V 50Hz 1 phase 0,7kW 0,95HP L 255mm rotation direction right capacitor 16µF LGB		
spare parts for	500486		
	GEV No.	Ref. No.	—
	operating capacitor capacity 16µF 425V		
	GEV No.	Ref. No.	1834R
	impellor ø 104 mm H 25 mm M8L		
	GEV No.	Ref. No.	1001R 1058R N/A
	mechanical shaft seal for shaft ø 13 mm		
	GEV No.	Ref. No.	0438R
	bracket mounting distance 130mm		
	GEV No.	Ref. No.	2899R
	fanwheel cover suitable for LGB ID ø 138mm		
	GEV No.	Ref. No.	0758R 0758R (blu)
	pump cover LGB inlet ø 60 mm outlet ø 50 mm		
	GEV No.	Ref. No.	1743R
	O-ring EPDM thickness 2,62mm ID ø 120,32mm		



GEV No.	500377	Ref. No.	EPR1007 ZF800DX
description	pump inlet ø 61mm outlet ø 52mm type ZF800DX 230/400V 50Hz 3 phase 2kW 2,72HP L 330mm rotation direction left LGB		
spare parts for	500377		
	GEV No.	Ref. No.	0049R
	pump cover gasket ID ø 158,3 mm		
	GEV No.	Ref. No.	N/A
	mechanical shaft seal for shaft ø 13 mm		
	GEV No.	Ref. No.	1360-1R
	impellor ø 120 mm H 39 mm pump type ZF800DX		
	GEV No.	Ref. No.	0648R
	pump cover LGB inlet ø 62 mm outlet ø 52 mm		





GEV No.	500380	Ref. No.	EPR1208 ZF1200SX
description	pump inlet ø 61mm outlet ø 61mm type ZF1200SX 230/400V 50Hz 3 phase 3,2kW 4,4HP L 370mm rotation direction right capacitor 16µF LGB		
spare parts for	500380		
	GEV No.	Ref. No.	1158R
	O-ring EPDM thickness 3,53mm ID ø 183,75mm		
	GEV No.	Ref. No.	1139R
	pump cover LGB inlet ø 61 mm outlet ø 61 mm		

Table continues overleaf

Зип Общепит





vsezip.ru

+7(812)987-08-81

spare parts for 500380			
	GEV No.	521054	Ref. No. 1161-1R
impellor ø 135 mm H 37 mm shaft intake ø 18 mm			
	GEV No.	521055	Ref. No. 1159R
slide ring with gasket ID ø 21 mm			
	GEV No.	521056	Ref. No. 1160R
slide ring for shaft ø 20mm ED ø 39mm H 16mm			







1

GEV No.	499241	Ref. No.	ZF650SX
description	pump inlet ø 62mm outlet ø 48mm type ZF650SX 230/400V 50Hz 3 phase 1,33kW L 340mm rotation direction right LGB		
spare parts for 499241			
	GEV No.	510551	Ref. No. 0049R
pump cover gasket ID ø 158,3 mm			
	GEV No.	510694	Ref. No. N/A
mechanical shaft seal for shaft ø 13 mm			
	GEV No.	521240	Ref. No. 2500R
impellor ø 110 mm H 32 mm rotation direction left			
	GEV No.	521536	Ref. No. 0022R
pump cover ALBA / LGB inlet ø 62 mm outlet ø 50 mm			



1

GEV No.	500376	Ref. No.	AM5225SX EPR1020 EPR1020A
description	pump inlet ø 62mm outlet ø 50mm type AM5225SX 230V 50Hz 1 phase 0,9kW 1,2HP L 300mm rotation direction right capacitor 16µF LGB		
spare parts for 500376			
	GEV No.	365021	Ref. No. —
operating capacitor capacity 16µF 425V			
	GEV No.	510551	Ref. No. 0049R
pump cover gasket ID ø 158,3 mm			
	GEV No.	510694	Ref. No. N/A
mechanical shaft seal for shaft ø 13 mm			
	GEV No.	512029	Ref. No. 1339D103
impellor ø 103 mm H 26 mm thread M8L shaft ø 19 mm			
	GEV No.	521536	Ref. No. 0022R
pump cover ALBA / LGB inlet ø 62 mm outlet ø 50 mm			







Зип Общепит

vsezip.ru

+7(812)987-08-81







1

GEV No.	500362	Ref. No.	CE150SX EPR0727
description	pump inlet \varnothing 62mm outlet \varnothing 50mm type CE150SX 230/400V 50Hz 3 phase 1,1kW 1,5HP L 280mm rotation direction right LGB		
spare parts for	500362		
	GEV No.	510551	Ref. No. 0049R
	pump cover gasket ID \varnothing 158,3 mm		
	GEV No.	510693	Ref. No. N/A
	mechanical shaft seal for shaft \varnothing 12 mm		
	GEV No.	521240	Ref. No. 2500R
	impellor \varnothing 110 mm H 32 mm rotation direction left		
	GEV No.	521536	Ref. No. 0022R
	pump cover ALBA / LGB inlet \varnothing 62 mm outlet \varnothing 50 mm		
	GEV No.	602013	Ref. No. Lüfterrad für 500362 Ventola per 500362
	fan wheel \varnothing 100mm H 28mm shaft intake \varnothing 17,5mm		



1

GEV No.	500360	Ref. No.	EPR1231 ZF522SX
description	pump inlet \varnothing 62mm outlet \varnothing 50mm type ZF522SX 230V 50Hz 1 phase 1,1kW 1,5HP L 220mm rotation direction right capacitor 16 μ F LGB		
spare parts for	500360		
	GEV No.	365021	Ref. No. —
	operating capacitor capacity 16 μ F 425V		
	GEV No.	510551	Ref. No. 0049R
	pump cover gasket ID \varnothing 158,3 mm		
	GEV No.	510693	Ref. No. N/A
	mechanical shaft seal for shaft \varnothing 12 mm		
	GEV No.	521280	Ref. No. 1339-1R
	impellor \varnothing 107 mm H 26 mm thread M8L shaft \varnothing 20 mm		
	GEV No.	521536	Ref. No. 0022R
	pump cover ALBA / LGB inlet \varnothing 62 mm outlet \varnothing 50 mm		

Зип Общественит

vsezip.ru

+7(812)987-08-81



GEV No.	499163	Ref. No.	C.F.2147 EPR 2147 kundenschutz ZF 522VSX
description	pump inlet ø 62mm outlet ø 50mm type ZF522VSX 230V 50Hz 1 phase 0,76kW 1HP L 255mm rotation direction right capacitor 16µF LGB		
spare parts for	499163		
	GEV No.	365021	Ref. No. —
	operating capacitor capacity 16µF 425V		
	GEV No.	510551	Ref. No. 0049R
	pump cover gasket ID ø 158,3 mm		
	GEV No.	510693	Ref. No. N/A
	mechanical shaft seal for shaft ø 12 mm		
	GEV No.	521239	Ref. No. 2510R
	impellor ø 110 mm H 26 mm rotation direction right		



GEV No.	500943	Ref. No.	EPR1625 ZF522VSX
description	pump inlet ø 62mm outlet ø 50mm type ZF522VSX 230V 50Hz 1 phase 0,7kW 0,95HP L 250mm rotation direction right capacitor 16µF LGB		
spare parts for	500943		
	GEV No.	365021	Ref. No. —
	operating capacitor capacity 16µF 425V		

spare parts for 500943			
	GEV No.	510551	Ref. No. 0049R
	pump cover gasket ID ø 158,3 mm		
	GEV No.	510694	Ref. No. N/A
	mechanical shaft seal for shaft ø 13 mm		
	GEV No.	512029	Ref. No. 1339D103
	impellor ø 103 mm H 26 mm thread M8L shaft ø 19 mm		
	GEV No.	521536	Ref. No. 0022R
	pump cover ALBA / LGB inlet ø 62 mm outlet ø 50 mm		



GEV No.	499267	Ref. No.	ZF523VSX
description	pump inlet ø 62mm outlet ø 50mm type ZF523VSX 230/400V 60Hz 3 phase 1,1kW L 282mm rotation direction right LGB		
spare parts for	499267		
	GEV No.	510551	Ref. No. 0049R
	pump cover gasket ID ø 158,3 mm		
	GEV No.	510693	Ref. No. N/A
	mechanical shaft seal for shaft ø 12 mm		
	GEV No.	521093	Ref. No. Girante per Pompa ZF523 VSX 60Hz
	impellor ø 85 mm H 29 mm thread M8L shaft ø 20 mm		
	GEV No.	521536	Ref. No. 0022R
	pump cover ALBA / LGB inlet ø 62 mm outlet ø 50 mm		



Зип Общепит

vsezip.ru

+7(812)987-08-81



1

GEV No.	500379	Ref. No.	EPR1005 ZF650SX
description	pump inlet ø 62mm outlet ø 50mm type ZF650SX 230/400V 50Hz 3 phase 1,35kW 1,8HP L 335mm rotation direction right LGB		
spare parts for	500379		
	GEV No.	Ref. No.	510551 0049R
	pump cover gasket ID ø 158,3 mm		
	GEV No.	Ref. No.	510694 N/A
	mechanical shaft seal for shaft ø 13 mm		
	GEV No.	Ref. No.	521240 2500R
	impellor ø 110 mm H 32 mm rotation direction left		
	GEV No.	Ref. No.	521536 0022R
	pump cover ALBA / LGB inlet ø 62 mm outlet ø 50 mm		



1

GEV No.	500378	Ref. No.	EPR1006 ZF800SX
description	pump inlet ø 62mm outlet ø 50mm type ZF800SX 230/400V 50Hz 3 phase 2kW 2,72HP L 340mm rotation direction right LGB		
spare parts for	500378		
	GEV No.	Ref. No.	510551 0049R
	pump cover gasket ID ø 158,3 mm		
	GEV No.	Ref. No.	510694 N/A
	mechanical shaft seal for shaft ø 13 mm		
	GEV No.	Ref. No.	521242 2853R
	impellor ø 115 mm H 36 mm M8L shaft intake ø 12 mm		
	GEV No.	Ref. No.	521536 0022R
	pump cover ALBA / LGB inlet ø 62 mm outlet ø 50 mm		



1

GEV No.	499238	Ref. No.	ZF650SX
description	pump inlet ø 62mm outlet ø 50mm type ZF650SX 230/400V 50Hz 3 phase 1,7kW L 340mm rotation direction right LGB		
spare parts for	499238		
	GEV No.	Ref. No.	510551 0049R
	pump cover gasket ID ø 158,3 mm		
	GEV No.	Ref. No.	510694 N/A
	mechanical shaft seal for shaft ø 13 mm		
	GEV No.	Ref. No.	521094 2853R
	impellor ø 105 mm H 34 mm thread M8L shaft ø 27 mm		
	GEV No.	Ref. No.	521536 0022R
	pump cover ALBA / LGB inlet ø 62 mm outlet ø 50 mm		



1

GEV No.	499247	Ref. No.	1612 ZF650DX
description	pump inlet ø 62mm outlet ø 51mm type ZF650DX 230/400V 50Hz 3 phase 1,1kW L 333mm rotation direction left LGB		
spare parts for	499247		
	GEV No.	Ref. No.	510551 0049R
	pump cover gasket ID ø 158,3 mm		
	GEV No.	Ref. No.	510694 N/A
	mechanical shaft seal for shaft ø 13 mm		
	GEV No.	Ref. No.	521095 1360-1R
	impellor ø 110 mm H 39 mm thread M8R shaft ø 30 mm		
	GEV No.	Ref. No.	521516 0648R
	pump cover LGB inlet ø 62 mm outlet ø 52 mm		

Зип Общественит

vsezip.ru

+7(812)987-08-81



1			
GEV No.	500122	Ref. No.	AM5225DX EPR0854
description	pump inlet ø 62mm outlet ø 52mm type AM5225DX 230/400V 50Hz 3 phase 1,2kW 1,6HP L 300mm rotation direction left LGB		
spare parts for	500122		
	GEV No.	Ref. No.	501495 0189R
	cover plastic for terminal box for pump LGB		
	GEV No.	Ref. No.	510551 0049R
	pump cover gasket ID ø 158,3 mm		
	GEV No.	Ref. No.	510694 N/A
	mechanical shaft seal for shaft ø 13 mm		
	GEV No.	Ref. No.	521236 0120D105
	impellor ø 105 mm H 32 mm M8R		
	GEV No.	Ref. No.	521516 0648R
	pump cover LGB inlet ø 62 mm outlet ø 52 mm		

spare parts for 500636			
	GEV No.	Ref. No.	510551 0049R
	pump cover gasket ID ø 158,3 mm		
	GEV No.	Ref. No.	510694 N/A
	mechanical shaft seal for shaft ø 13 mm		
	GEV No.	Ref. No.	521217 N/A
	impellor ø 110 mm H 32 mm thread M8R shaft ø 20 mm		
	GEV No.	Ref. No.	521516 0648R
	pump cover LGB inlet ø 62 mm outlet ø 52 mm		



1			
GEV No.	500536	Ref. No.	AM5225DX EPR1229
description	pump inlet ø 62mm outlet ø 52mm type AM5225DX 230V 50Hz 1 phase 0,9kW 1,2HP L 300mm rotation direction left capacitor 20µF LGB		
spare parts for	500536		
	GEV No.	Ref. No.	365019 —
	operating capacitor capacity 20µF 400V		



1			
GEV No.	501363	Ref. No.	AM5226DX EPR0444 EPR0444A
description	pump inlet ø 62mm outlet ø 52mm type AM5226 230/400V 50Hz 0,65kW L 295mm rotation direction left LGB		
spare parts for	501363		
	GEV No.	Ref. No.	510551 0049R
	pump cover gasket ID ø 158,3 mm		
	GEV No.	Ref. No.	510694 N/A
	mechanical shaft seal for shaft ø 13 mm		
	GEV No.	Ref. No.	521141 0120-1R
	impellor ø 70 mm H 32 mm thread M8R shaft ø 20 mm		
	GEV No.	Ref. No.	521516 0648R
	pump cover LGB inlet ø 62 mm outlet ø 52 mm		

→ electric components



Зип-Общепит

vsezip.ru

+7(812)987-08-81



GEV No.	499299	Ref. No.	AM5226DX (DPE1906)
description	pump inlet \varnothing 62mm outlet \varnothing 52mm type AM5226DX 220-240/380-415V 60Hz 3 phase 0,55kW L 293mm rotation direction left LGB		
spare parts for	499299		
	GEV No.	510551	Ref. No. 0049R
	pump cover gasket ID \varnothing 158,3 mm		
	GEV No.	510694	Ref. No. N/A
	mechanical shaft seal for shaft \varnothing 13 mm		
	GEV No.	521141	Ref. No. 0120-1R
	impellor \varnothing 70 mm H 32 mm thread M8R shaft \varnothing 20 mm		
	GEV No.	521516	Ref. No. 0648R
	pump cover LGB inlet \varnothing 62 mm outlet \varnothing 52 mm		



GEV No.	500537	Ref. No.	EPR1099 ZF522VDX
description	pump inlet \varnothing 62mm outlet \varnothing 52mm type ZF522VDX 230V 50Hz 1 phase 0,85kW 1,16HP L 255mm rotation direction left capacitor 16 μ F auxiliary pressure connection 12mm supporting pressure open LGB		
spare parts for	500537		
	GEV No.	365021	Ref. No. —
	operating capacitor capacity 16 μ F 425V		
	GEV No.	510551	Ref. No. 0049R
	pump cover gasket ID \varnothing 158,3 mm		
	GEV No.	510693	Ref. No. N/A
	mechanical shaft seal for shaft \varnothing 12 mm		

spare parts for 500537			
GEV No.	521281	Ref. No.	0120D90
	impellor \varnothing 90 mm H 30 mm thread M8R shaft \varnothing 20 mm		
GEV No.	521516	Ref. No.	0648R
	pump cover LGB inlet \varnothing 62 mm outlet \varnothing 52 mm		



GEV No.	499242	Ref. No.	C.F.2561 ZF650DX
description	pump inlet \varnothing 62mm outlet \varnothing 52mm type ZF650DX 230V 50Hz 1 phase 1,47kW L 335mm rotation direction left capacitor 20 μ F LGB		
spare parts for	499242		
	GEV No.	365019	Ref. No. —
	operating capacitor capacity 20 μ F 400V		
	GEV No.	510551	Ref. No. 0049R
	pump cover gasket ID \varnothing 158,3 mm		
	GEV No.	510694	Ref. No. N/A
	mechanical shaft seal for shaft \varnothing 13 mm		
	GEV No.	521217	Ref. No. N/A
	impellor \varnothing 110 mm H 32 mm thread M8R shaft \varnothing 20 mm		
	GEV No.	521516	Ref. No. 0648R
	pump cover LGB inlet \varnothing 62 mm outlet \varnothing 52 mm		







Зип Общепит

vsezip.ru

+7(812)987-08-81







1

GEV No.	500780	Ref. No.	EPR1611 ZF800DX
description	pump inlet ø 62mm outlet ø 52mm type ZF800DX 230/400V 50Hz 3 phase 1,5kW 2HP L 340mm rotation direction left LGB		
spare parts for	500780		
	GEV No.	510551	Ref. No. 0049R
	pump cover gasket ID ø 158,3 mm		
	GEV No.	510694	Ref. No. N/A
	mechanical shaft seal for shaft ø 13 mm		
	GEV No.	521276	Ref. No. 1360-1R
	impellor ø 120 mm H 39 mm pump type ZF800DX		
	GEV No.	521516	Ref. No. 0648R
	pump cover LGB inlet ø 62 mm outlet ø 52 mm		

spare parts for 499141			
	GEV No.	521516	Ref. No. 0648R
	pump cover LGB inlet ø 62 mm outlet ø 52 mm		





1

GEV No.	499287	Ref. No.	ZF800DX (TR0080)
description	pump inlet ø 62mm outlet ø 52mm type ZF800DX 230/400V 50Hz 3 phase 2,7kW L 332mm rotation direction left LGB		
spare parts for	499287		
	GEV No.	510551	Ref. No. 0049R
	pump cover gasket ID ø 158,3 mm		
	GEV No.	510694	Ref. No. N/A
	mechanical shaft seal for shaft ø 13 mm		
	GEV No.	521276	Ref. No. 1360-1R
	impellor ø 120 mm H 39 mm pump type ZF800DX		
	GEV No.	521516	Ref. No. 0648R
	pump cover LGB inlet ø 62 mm outlet ø 52 mm		



1

GEV No.	499141	Ref. No.	EPR1874 ZF800DX
description	pump inlet ø 62mm outlet ø 52mm type ZF800DX 230/400V 50Hz 3 phase 1,65kW 2,2HP L 336mm rotation direction left auxiliary pressure connection 12mm supporting pressure closed LGB		
spare parts for	499141		
	GEV No.	510551	Ref. No. 0049R
	pump cover gasket ID ø 158,3 mm		
	GEV No.	510694	Ref. No. N/A
	mechanical shaft seal for shaft ø 13 mm		
	GEV No.	521276	Ref. No. 1360-1R
	impellor ø 120 mm H 39 mm pump type ZF800DX		



1

GEV No.	500733	Ref. No.	AM5225SX EPR2495
description	pump inlet ø 63mm outlet ø 48mm type AM5225SX 230/400V 50Hz 3 phase 0,9kW 1,2HP L 300mm rotation direction right LGB		

→ electric components







Зип-Общепит

vsezip.ru

+7(812)987-08-81



1

GEV No.	500779	Ref. No.	EPR1489 ZF523VSX
description	pump inlet \varnothing 63mm outlet \varnothing 48mm type ZF523VSX 230/400V 50Hz 3 phase 1kW 1,36HP L 280mm rotation direction right LGB		
spare parts for	500779		
	GEV No.	510551	Ref. No. 0049R
	pump cover gasket ID \varnothing 158,3 mm		
	GEV No.	510693	Ref. No. N/A
	mechanical shaft seal for shaft \varnothing 12 mm		
	GEV No.	521097	Ref. No. 1388-1R
	impellor \varnothing 100 mm H 31 mm thread M8L shaft \varnothing 20 mm		
	GEV No.	521536	Ref. No. 0022R
	pump cover ALBA / LGB inlet \varnothing 62 mm outlet \varnothing 50 mm		

spare parts for 500469			
GEV No.	521240	Ref. No.	2500R
	impellor \varnothing 110 mm H 32 mm rotation direction left		
GEV No.	521536	Ref. No.	0022R
	pump cover ALBA / LGB inlet \varnothing 62 mm outlet \varnothing 50 mm		





image not available

GEV No.	500960	Ref. No.	EPR2042 ZF650SX
description	pump inlet \varnothing 63mm outlet \varnothing 48mm type ZF650SX 230V 50Hz 1 phase 1,47kW 2HP L 340mm rotation direction right capacitor 20 μ F LGB inlet \varnothing 63mm outlet \varnothing 48mm		



1

GEV No.	500469	Ref. No.	EPR1806 ZF650SX
description	pump inlet \varnothing 63mm outlet \varnothing 48mm type ZF650SX 230/400V 50Hz 3 phase 1,35kW 1,83HP L 335mm rotation direction right LGB		
spare parts for	500469		
	GEV No.	510551	Ref. No. 0049R
	pump cover gasket ID \varnothing 158,3 mm		
	GEV No.	510694	Ref. No. N/A
	mechanical shaft seal for shaft \varnothing 13 mm		



1

GEV No.	499271	Ref. No.	ZF650SX (ATA 8214)
description	pump inlet \varnothing 63mm outlet \varnothing 61mm type ZF650SX 230/400V 50Hz 3 phase 0,95kW L 340mm rotation direction right LGB		

Зип Общепит

vsezip.ru

+7(812)987-08-07



1

GEV No.	499083	Ref. No.	EPR1829 ZF650SX (ATA 9821)
description	pump inlet \varnothing 63mm outlet \varnothing 63mm type ZF650SX 230/400V 50Hz 3 phase 1,5kW L 335mm		
spare parts for	499083		
	GEV No.	510551	Ref. No. 0049R
	pump cover gasket ID \varnothing 158,3 mm		
	GEV No.	510694	Ref. No. N/A
	mechanical shaft seal for shaft \varnothing 13 mm		
image not available	GEV No.	521069	Ref. No. 0180R
	fanwheel cover		
	GEV No.	521240	Ref. No. 2500R
	impellor \varnothing 110 mm H 32 mm rotation direction left		
	GEV No.	521537	Ref. No. N/A
	pump cover inlet \varnothing 62 mm outlet \varnothing 62 mm		

spare parts for 499101

	GEV No.	502280	Ref. No.	N/A
	pump sump LGB auxiliary pressure connection 7 mm			
	GEV No.	510703	Ref. No.	1001R 1058R N/A
	mechanical shaft seal for shaft \varnothing 13 mm			
	GEV No.	521234	Ref. No.	N/A
	impellor thread M8L ED \varnothing 93 mm W 16 mm			
	GEV No.	523509	Ref. No.	—
	deep-groove ball bearing type 6201-2RS			
	GEV No.	532537	Ref. No.	N/A
	O-ring EPDM thickness 3,53 mm ID \varnothing 113,9 mm			



1

GEV No.	499119	Ref. No.	1751
description	pump inlet \varnothing outlet \varnothing 38mm type RV54 230V 50Hz 1 phase 0,8kW L 380mm rotation direction right capacitor 16 μ F LGB with holder		
spare parts for	499119		
	GEV No.	365021	Ref. No. —
	operating capacitor capacity 16 μ F 425V		
	GEV No.	502280	Ref. No. N/A
	pump sump LGB auxiliary pressure connection 7 mm		
	GEV No.	510703	Ref. No. 1001R 1058R N/A
	mechanical shaft seal for shaft \varnothing 13 mm		
	GEV No.	521234	Ref. No. N/A
	impellor thread M8L ED \varnothing 93 mm W 16 mm		
	GEV No.	523509	Ref. No. —
	deep-groove ball bearing type 6201-2RS		
	GEV No.	532537	Ref. No. N/A
	O-ring EPDM thickness 3,53 mm ID \varnothing 113,9 mm		



1

GEV No.	499101	Ref. No.	C600/PS60 2248 C600/PS60 79056
description	pump inlet \varnothing outlet \varnothing 38mm type C600 230V 50Hz 1 phase 0,8kW L 220mm rotation direction right capacitor 16 μ F LGB with drain and flange		
spare parts for	499101		
	GEV No.	365021	Ref. No. —
	operating capacitor capacity 16 μ F 425V		



Зип Общепит

vsezip.ru

+7(812)987-08-81



1

GEV No.	500153	Ref. No.	W1805X
description	pump inlet \varnothing outlet \varnothing type W1805X 230V 50Hz 1 phase 0,19kW 0,26HP L 220mm rotation direction right capacitor 5 μ F LGB		
spare parts for	500153		
	GEV No.	365017	Ref. No. —
	operating capacitor capacity 5 μ F 450V		
	GEV No.	510703	Ref. No. 1001R 1058R N/A
	mechanical shaft seal for shaft \varnothing 13 mm		
	GEV No.	513267	Ref. No. —
	end cap for wash pump suitable for pump casing		
	GEV No.	518177	Ref. No. N/A
	drain unit thread 3/4" ID \varnothing 35mm hose \varnothing 24mm		
	GEV No.	518204	Ref. No. —
	screw connection for filter \varnothing 67mm		
	GEV No.	518205	Ref. No. —
	flat gasket rubber D1 \varnothing 61mm D2 \varnothing 47mm		
	GEV No.	521147	Ref. No. —
	flange		
	GEV No.	521221	Ref. No. N/A
	impellor \varnothing 67 mm H 16 mm rotation direction right		
	GEV No.	528800	Ref. No. 0042R
	O-ring EPDM thickness 2,62 mm ID \varnothing 75,87 mm		



1

GEV No.	500150	Ref. No.	EPR130980 W2105X
description	pump inlet \varnothing outlet \varnothing type W2105X 230V 50Hz 1 phase 0,24kW 0,33HP L 230mm rotation direction right capacitor 6,3 μ F LGB		
spare parts for	500150		
	GEV No.	365012	Ref. No. —
	operating capacitor capacity 6,3 μ F 450V		
	GEV No.	509004	Ref. No. 0951R
	impellor \varnothing 71 mm H 16 mm M7L		
	GEV No.	510703	Ref. No. 1001R 1058R N/A
	mechanical shaft seal for shaft \varnothing 13 mm		
	GEV No.	513267	Ref. No. —
	end cap for wash pump suitable for pump casing		
	GEV No.	513275	Ref. No. N/A
	O-ring EPDM thickness 1,78mm ID \varnothing 82,27mm		
	GEV No.	518177	Ref. No. N/A
	drain unit thread 3/4" ID \varnothing 35mm hose \varnothing 24mm		
	GEV No.	518204	Ref. No. —
	screw connection for filter \varnothing 67mm		
	GEV No.	518205	Ref. No. —
	flat gasket rubber D1 \varnothing 61mm D2 \varnothing 47mm		
	GEV No.	521147	Ref. No. —
	flange		



Зип Общепит

vsezip.ru

+7(812)987-08-81



1

GEV No.	500390	Ref. No.	ELET.FM4023SX FM4022SX
description	pump type FM4022SX 230V 50Hz 1 phase 0,5kW 0,86HP rotation direction right capacitor 16µF LGB		
spare parts for	500390		
	GEV No.	365021	Ref. No. —
	operating capacitor capacity 16µF 425V		
	GEV No.	510703	Ref. No. 1001R 1058R N/A
	mechanical shaft seal for shaft ø 13 mm		
	GEV No.	521246	Ref. No. 0591-1R
	impellor ø 103 mm H 26 mm thread M8L shaft ø 20 mm		
	GEV No.	521542	Ref. No. 0878R
	pump cover LGB inlet ø 45 mm outlet ø 40 mm		
	GEV No.	521714	Ref. No. 0046R 3283R
	pump cover gasket thickness 4x4mm Qty 1 pcs		

spare parts and accessories

mechanical shaft seals



1

GEV No.	510692	Ref. No.	N/A
description	mechanical shaft seal for shaft ø 11mm slide ring ext. ø 24mm slide ring H 13mm counter ring mounting ø 26mm height counter ring 8mm counter ring int. ø 14mm		

GEV No.	510693	Ref. No.	N/A
description	mechanical shaft seal for shaft ø 12mm slide ring ext. ø 24mm slide ring H 15,5mm slide ring int. ø 11mm counter ring mounting ø 24mm height counter ring 8mm counter ring int. ø 14mm		

GEV No.	510694	Ref. No.	N/A
description	mechanical shaft seal for shaft ø 13mm height counter ring 8mm ID ø 11,5mm H 16mm mounting ø 24/26mm int. ø 14mm		

GEV No.	510703	Ref. No.	1001R 1058R N/A
description	mechanical shaft seal for shaft ø 13mm slide ring H 13mm height counter ring 5,5mm ED ø 26mm		

GEV No.	510690	Ref. No.	N/A
description	mechanical shaft seal for shaft ø 8mm ED ø 24mm mounting ø 24/26mm		

→ electric components

Зип Общепит

vsezip.ru

+7(812)987-08-81



1

GEV No.	510702	Ref. No.	N/A
description	mechanical shaft seal height counter ring 5,5mm ID ø 12mm		



1

GEV No.	521056	Ref. No.	1160R
description	slide ring for shaft ø 20mm ED ø 39mm H 16mm ID ø 18,5mm		



1

GEV No.	521055	Ref. No.	1159R
description	slide ring with gasket ID ø 21mm height counter ring 8mm mounting ø 42mm		

impellers



1

GEV No.	502279	Ref. No.	2038R
description	impellor H 31mm ED ø 100mm blades 6		



1

GEV No.	521097	Ref. No.	1388-1R
description	impellor ø 100mm H 31mm thread M8L shaft ø 20mm shaft length 14mm		



1

GEV No.	521087	Ref. No.	2038-1R
description	impellor ø 100mm H 32mm thread M8L		



1

GEV No.	521090	Ref. No.	Girante per Pompa ZF400SX EPR2287
description	impellor ø 101mm H 32mm thread M8L shaft ø 13mm shaft length 12mm		



1

GEV No.	521042	Ref. No.	0116R Girante Pompa EPR0524(ZF210SX)
description	impellor ø 103mm H 14mm pump type ZF210SX thread M10L		

Зип Общепит

vsezip.ru

+7(812)987-08-81



1

GEV No.	512029	Ref. No.	1339D103
description	impellor \varnothing 103mm H 26mm thread M8L shaft \varnothing 19mm shaft length 15mm seat \varnothing 8,2mm		



1

GEV No.	521111	Ref. No.	1574-1R
description	impellor \varnothing 105mm H 29mm thread M8R shaft \varnothing 20mm shaft length 5mm		



1

GEV No.	521246	Ref. No.	0591-1R
description	impellor \varnothing 103mm H 26mm thread M8L shaft \varnothing 20mm shaft length 7mm seat \varnothing 8,2mm blades 6		



1

GEV No.	521236	Ref. No.	0120D105
description	impellor \varnothing 105mm H 32mm M8R		



1

GEV No.	509020	Ref. No.	1834R
description	impellor \varnothing 104mm H 25mm M8L		



1

GEV No.	521094	Ref. No.	2853R
description	impellor \varnothing 105mm H 34mm thread M8L shaft \varnothing 27mm shaft length 7mm		



1

GEV No.	510616	Ref. No.	0123R
description	impellor \varnothing 104mm H 25mm shaft intake \varnothing 10mm		



1

GEV No.	521280	Ref. No.	1339-1R
description	impellor \varnothing 107mm H 26mm thread M8L shaft \varnothing 20mm shaft length 15mm seat \varnothing 8,2mm blades 6		



Зип Общепит

vsezip.ru

+7(812)987-08-81

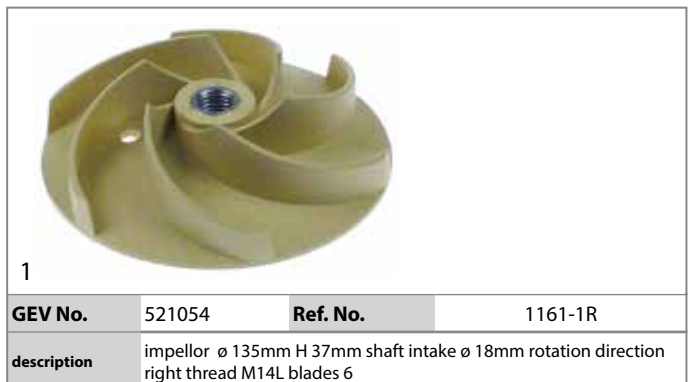
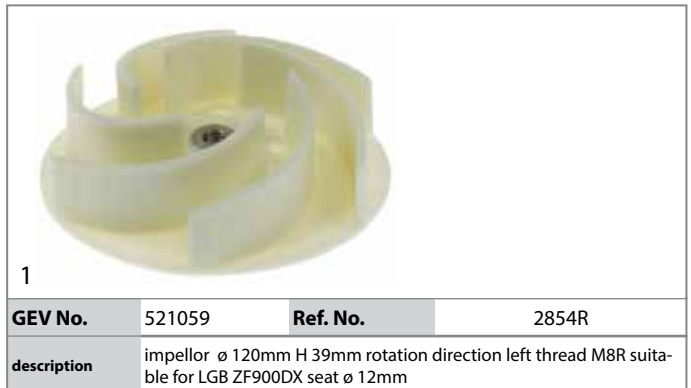
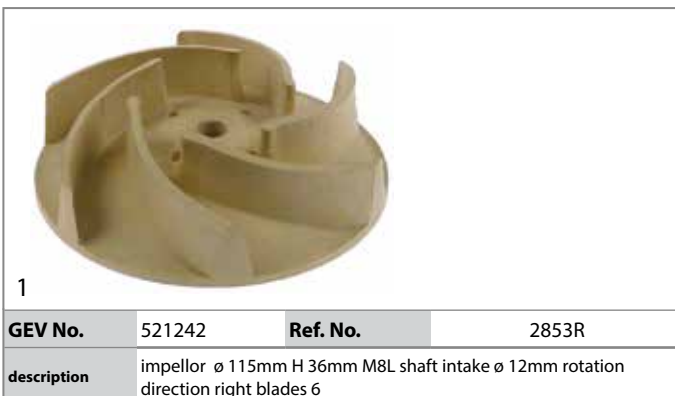
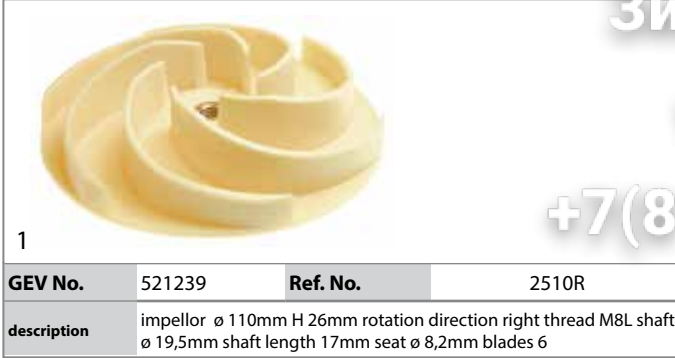



Зип Общепит

vsezip.ru

+7(812)987-08-81



1

GEV No.	698663	Ref. No.	0965R
description	impeller ø 60mm H 12mm with flute shaft intake ø 12mm W 60mm suitable for LGB		

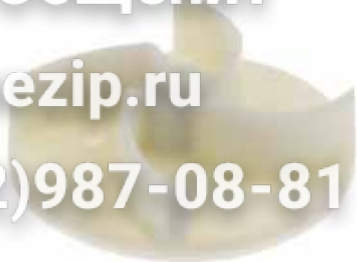



1

GEV No.	698765	Ref. No.	N/A
description	impeller ø 70mm H 21mm rotation direction right thread M7L suitable for LGB shaft ø 13mm shaft length 20mm blades 4		



1

GEV No.	530455	Ref. No.	0101-1R
description	impeller ø 60mm H 30mm screw mounting shaft intake ø M5mm rotation direction left suitable for LGB for ZF115M7 DX shaft ø M5mm shaft length 26mm blades 3		
accessories for	530455		
	GEV No.	500542	Ref. No. EPR0459 ZF-130DX
pump inlet ø 28mm outlet ø 26mm type ZF130DX 230V			



1

GEV No.	521141	Ref. No.	0120-1R
description	impeller ø 70mm H 32mm thread M8R shaft ø 20mm shaft length 9mm		



1

GEV No.	521223	Ref. No.	1517R
description	impeller ø 61mm H 17mm thread M7L shaft ø 13mm shaft length 12mm		



1

GEV No.	509004	Ref. No.	0951R
description	impeller ø 71mm H 16mm M7L rotation direction right shaft ø 13mm shaft length 13mm blades 8		



1

GEV No.	521221	Ref. No.	N/A
description	impeller ø 67mm H 16mm rotation direction right thread M7L shaft ø 13mm shaft length 12mm blades 8		



1

GEV No.	521228	Ref. No.	0105-1R
description	impeller ø 72mm H 17mm rotation direction left thread M7R shaft ø 13mm shaft length 12mm blades 3		

→ electric components



Зип Общепит

vsezip.ru

+7(812)987-08-81



1

GEV No.	521085	Ref. No.	0106-1R
description	impellor ø 72mm H 17mm thread M7L shaft ø 13mm shaft length 12mm blades 3		



1

GEV No.	521083	Ref. No.	0815R
description	impellor ø 73mm H 13mm thread M7R blades 3 metal		



1

GEV No.	521099	Ref. No.	1580-1R
description	impellor ø 72mm H 17mm thread M7R shaft ø 13mm shaft length 12mm		



1

GEV No.	521092	Ref. No.	2574R Girante per Pompa CRC-R DX EPR2570A
description	impellor ø 80mm H 25mm pump type CRC-R DX thread M6R shaft ø 13mm shaft length 20mm		



1

GEV No.	521008	Ref. No.	0109-1R
description	impellor ø 72mm H 22mm rotation direction left thread M7R shaft ø 13mm shaft length 12mm		



1

GEV No.	521150	Ref. No.	N/A
description	impellor ø 85mm H 17mm thread M8R shaft ø 13mm shaft length 10mm		



1

GEV No.	521225	Ref. No.	0110-1R
description	impellor ø 72mm H 22mm rotation direction right thread M7L shaft ø 13mm shaft length 12mm		



1

GEV No.	521093	Ref. No.	Girante per Pompa ZF523 VSX 60Hz
description	impellor ø 85mm H 29mm thread M8L shaft ø 20mm shaft length 10mm		

Зип Общепит

vsezip.ru

+7(812)987-08-81



1

GEV No.	521230	Ref. No.	N/A
description	impellor ø 86mm H 16mm M7L		



1

GEV No.	521247	Ref. No.	N/A
description	impellor ø 90mm H 27mm rotation direction right thread M8L blades 6		





image not available

GEV No.	521040	Ref. No.	1857
description	impellor ø 88mm H 16mm pump type ZF220SX rotation direction right thread M8L		



1

GEV No.	521281	Ref. No.	0120D90
description	impellor ø 90mm H 30mm thread M8R shaft ø 20mm shaft length 10mm seat ø 8,2mm blades 6		



1

GEV No.	521024	Ref. No.	N/A
description	impellor ø 88mm H 30mm rotation direction right thread M7L shaft ø 12mm blades 6		



1

GEV No.	521112	Ref. No.	N/A
description	impellor ø 93mm H 21mm pump type ZF220VSX thread M8L shaft ø 13mm shaft length 11mm		



1

GEV No.	521089	Ref. No.	2037R
description	impellor ø 88mm H 32mm thread M8L		



1

GEV No.	521278	Ref. No.	2037R
description	impellor ø 93mm H 32mm pump type ZF350SX thread M8L		



Зип Общепит

vsezip.ru

+7(812)987-08-81



1

GEV No.	521300	Ref. No.	0697-1R
description	impeller ø 94mm H 27mm pump type ZF320SX thread M8L		



1

GEV No.	521106	Ref. No.	0114-1R
description	impeller ø 97mm H 24mm rotation direction right thread M8L seat ø 8,2mm blades 5		



1

GEV No.	521234	Ref. No.	N/A
description	impeller thread M8L ED ø 93mm W 16mm		

pump covers



1

GEV No.	518177	Ref. No.	N/A
description	drain unit thread 3/4" ID ø 35mm hose ø 24mm		

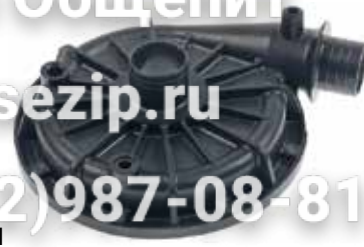

1

GEV No.	502267	Ref. No.	0935-1R
description	pump cover		



1

GEV No.	521564	Ref. No.	N/A
description	pump cover		



1

GEV No.	521536	Ref. No.	0022R
description	pump cover ALBA / LGB inlet ø 62mm outlet ø 50mm auxiliary pressure connection 12mm supporting pressure closed turn direction right ø 180mm ID ø 150mm inner height 38mm		



1

GEV No.	502266	Ref. No.	0881R
description	pump cover inlet ø 28mm outlet ø 26mm		



Зип Общепит

vsezip.ru

+7(812)987-08-81



image not available

GEV No.	521037	Ref. No.	0246
description	pump cover inlet ϕ 45mm outlet ϕ 40mm pump type ZF220SX		



2

GEV No.	521537	Ref. No.	N/A
description	pump cover inlet ϕ 62mm outlet ϕ 62mm auxiliary pressure connection 12mm supporting pressure closed turn direction right ϕ 180mm ID ϕ 150mm inner height 38mm		



1

GEV No.	521119	Ref. No.	2135R
description	pump cover LGB inlet ϕ 28mm outlet ϕ 12mm auxiliary pressure connection 12mm pump type ZF131DX		



1

GEV No.	698770	Ref. No.	N/A
description	pump cover LGB inlet ϕ 28mm outlet ϕ 22/28mm ϕ 108mm ID ϕ 84mm		



1

GEV No.	521084	Ref. No.	1263R
description	pump cover LGB inlet ϕ 28mm outlet ϕ 25mm auxiliary pressure connection 13mm pump type ZF131DX ID ϕ 78mm		



1

GEV No.	521098	Ref. No.	1649R
description	pump cover LGB inlet ϕ 28mm outlet ϕ 26mm auxiliary pressure connection 12mm ID ϕ 77mm		



1

GEV No.	521107	Ref. No.	0001R
description	pump cover LGB inlet ϕ 28mm outlet ϕ 26mm auxiliary pressure connection 12mm ID ϕ 77mm		



1

GEV No.	521057	Ref. No.	1650R
description	pump cover LGB inlet ϕ 28mm outlet ϕ 26mm auxiliary pressure connection 12mm supporting pressure open turn direction right ϕ 102mm ID ϕ 77mm inner height 31mm		

Зип Общепит

vsezip.ru

+7(812)987-08-81



1

GEV No.	510122	Ref. No.	0002R
description	pump cover LGB inlet \varnothing 28mm outlet \varnothing 26mm auxiliary pressure connection 13mm supporting pressure open \varnothing 98mm ID \varnothing 77mm inner height 31mm		



1

GEV No.	521527	Ref. No.	0645R
description	pump cover LGB inlet \varnothing 30mm outlet \varnothing 30mm		



1

GEV No.	521524	Ref. No.	0882R
description	pump cover LGB inlet \varnothing 28mm outlet \varnothing 26mm auxiliary pressure connection 13mm turn direction left \varnothing 98mm ID \varnothing 78mm inner height 25mm		



1

GEV No.	521526	Ref. No.	0009R 3286R
description	pump cover LGB inlet \varnothing 30mm outlet \varnothing 30mm auxiliary pressure connection 12mm supporting pressure open turn direction right \varnothing 117mm ID \varnothing 95mm inner height 19mm		



1

GEV No.	521091	Ref. No.	2576R
description	pump cover LGB inlet \varnothing 28mm outlet \varnothing 26mm pump type CRC-R DX		



1

GEV No.	521088	Ref. No.	N/A
description	pump cover LGB inlet \varnothing 33mm outlet \varnothing 26mm		



1

GEV No.	521007	Ref. No.	1774R
description	pump cover LGB inlet \varnothing 28mm outlet \varnothing 26mm turn direction left		



1

GEV No.	698768	Ref. No.	N/A
description	pump cover LGB inlet \varnothing 42mm pump type LA50 AP \varnothing 115mm ID \varnothing 36mm		



Зип Общепит

vsezip.ru

+7(812)987-08-81



1

GEV No.	521140	Ref. No.	Chiocciola per Pompa EPR2660/ ZF150SX
description	pump cover LGB inlet ø 45mm outlet ø 40mm auxiliary pressure connection 12mm pump type ZF150SX		



1

GEV No.	521086	Ref. No.	1435R
description	pump cover LGB inlet ø 50mm outlet ø 40mm		



1

GEV No.	521542	Ref. No.	0878R
description	pump cover LGB inlet ø 45mm outlet ø 40mm auxiliary pressure connection 13mm supporting pressure open ø 150mm ID ø 120mm inner height 25mm		



1

GEV No.	521548	Ref. No.	0020R
description	pump cover LGB inlet ø 50mm outlet ø 50mm		



1

GEV No.	521113	Ref. No.	N/A
description	pump cover LGB inlet ø 45mm outlet ø 40mm pump type ZF220VSX		



1

GEV No.	521108	Ref. No.	0021R
description	pump cover LGB inlet ø 50mm outlet ø 50mm auxiliary pressure connection 12mm		



1

GEV No.	521109	Ref. No.	1572R
description	pump cover LGB inlet ø 45mm outlet ø 40mm supporting pressure 12		



1

GEV No.	521547	Ref. No.	0758R 0758R (blu)
description	pump cover LGB inlet ø 60mm outlet ø 50mm supporting pressure M8 turn direction right ø 160mm ID ø 127mm inner height 36mm		
spare parts for	521547		
	GEV No.	503122	Ref. No. —
	hexagonal screw thread M8 thread L 10mm SS WS 13		
	GEV No.	510177	Ref. No. —
	O-ring EPDM thickness 1,78mm ID ø 7,66mm Qty 1 pcs		

Зип Общепит

vsezip.ru

+7(812)987-08-81

			
1			
GEV No.	521053	Ref. No.	1139R
description	pump cover LGB inlet ϕ 61mm outlet ϕ 61mm turn direction right ϕ 210mm ID ϕ 175mm inner height 41mm		

			
1			
GEV No.	521516	Ref. No.	0648R
description	pump cover LGB inlet ϕ 62mm outlet ϕ 52mm auxiliary pressure connection 12mm supporting pressure closed turn direction left ϕ 190mm ID ϕ 150mm inner height 40mm		
spare parts for	521516		
	GEV No.	503122	Ref. No. —
	hexagonal screw thread M8 thread L 10mm SS WS 13		
	GEV No.	510177	Ref. No. —
	O-ring EPDM thickness 1,78mm ID ϕ 7,66mm Qty 1 pcs		

			
1			
GEV No.	521149	Ref. No.	N/A
description	pump cover LGB outlet ϕ 38/31mm		

			
1			
GEV No.	502280	Ref. No.	N/A
description	pump sump LGB auxiliary pressure connection 7mm supporting pressure closed pump type RV54		

			
1			
GEV No.	698827	Ref. No.	N/A
description	threaded ring LGB pump type LA50 ϕ 120mm ID ϕ 70mm		

pump cover gaskets			
			
1			
GEV No.	521717	Ref. No.	N/A
description	O-ring EPDM thickness 1,78mm ID ϕ 120,37mm Qty 1 pcs		

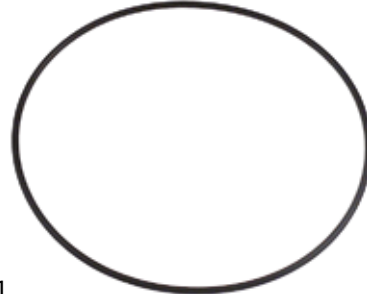
			
1			
GEV No.	513275	Ref. No.	N/A
description	O-ring EPDM thickness 1,78mm ID ϕ 82,27mm Qty 1 pcs		

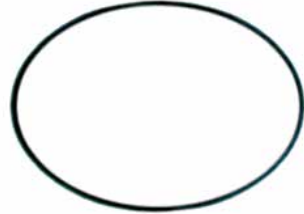
			
1			
GEV No.	510556	Ref. No.	N/A
description	O-ring EPDM thickness 1,78mm ID ϕ 94,97mm Qty 1 pcs pump type T110		

			
1			
GEV No.	532623	Ref. No.	1743R
description	O-ring EPDM thickness 2,62mm ID ϕ 120,32mm Qty 1 pcs		

Зип Общежит

vsezip.ru

+7(812)987-08-81



image not available

GEV No.	532719	Ref. No.	N/A
description	O-ring EPDM thickness 2,62mm ID ø 126,67mm Qty 1 pcs		



1

GEV No.	528800	Ref. No.	0042R
description	O-ring EPDM thickness 2,62mm ID ø 75,87mm Qty 1 pcs		



1

GEV No.	509002	Ref. No.	Guarnizione per Pompa CRC-R DX EPR 2570A
description	O-ring EPDM thickness 2,62mm ID ø 82,22mm Qty 1 pcs		

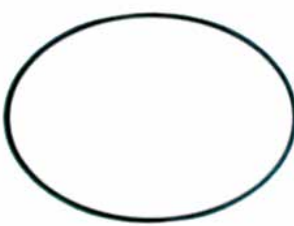

1

GEV No.	510554	Ref. No.	n/a
description	O-ring EPDM thickness 2mm ID ø 120mm Qty 1 pcs		

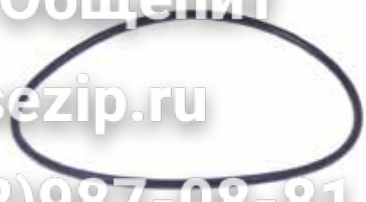

1

GEV No.	532537	Ref. No.	N/A
description	O-ring EPDM thickness 3,53mm ID ø 113,9mm Qty 1 pcs		

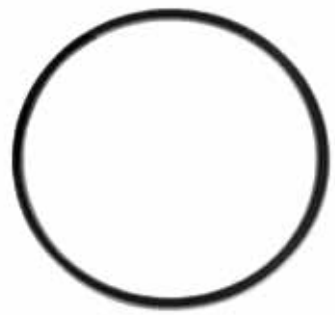

1

GEV No.	510896	Ref. No.	1158R
description	O-ring EPDM thickness 3,53mm ID ø 183,75mm Qty 1 pcs		



1

GEV No.	698810	Ref. No.	N/A
description	O-ring EPDM thickness 3,56mm ID ø 112mm Qty 1 pcs		



1

GEV No.	521701	Ref. No.	0044R
description	pump cover gasket		



image not available

GEV No.	521706	Ref. No.	2234R
description	pump cover gasket		



Зип Общепит

vsezip.ru

+7(812)987-08-81



image not available

			
1			
GEV No.	521703	Ref. No.	N/A
description	pump cover gasket EPDM thickness 2,5mm ID ø 75mm Qty 1 pcs		

			
1			
GEV No.	503125	Ref. No.	N/A
description	pump cover gasket EPDM thickness 3mm ID ø 129mm Qty 1 pcs		

			
1			
GEV No.	510551	Ref. No.	0049R
description	pump cover gasket ID ø 158,3mm pump type 1214/1293/1225/2243/1226/1204/3473/1241 thickness 3,53mm EPDM Qty 1 pcs		

			
1			
GEV No.	698400	Ref. No.	0682R
description	pump cover gasket pump type PS46 thickness 2mm ID ø 66mm Qty 1 pcs		

GEV No.	521038	Ref. No.	0045R
description	pump cover gasket pump type ZF220SX		

			
1			
GEV No.	521714	Ref. No.	0046R 3283R
description	pump cover gasket thickness 4x4mm Qty 1 pcs		