



Зип Общепит

vsezip.ru

+7(812)987-08-81



GAS COMPONENTS



ELECTRIC COMPONENTS



WATER TECHNOLOGY



MECHANICAL COMPONENTS



TOOLS

Spare parts suitable for

HOONVED

Find the complete and up-to-date range of products in our GEV Webshop

Зип Общепит

vsezip.ru

+7(812)987-08-81

Manufacturer catalogue

The most important spare parts and accessories arranged clearly for every manufacturer



Complete product range and all appliance data always up to date in the GEV Webshop







Alphabetical Index at the end of the catalogue

GEV Webshop

www.gev-online.co.uk

www.gev-online.com



-  Add to Favourites
-  Sign In with email address and usual password
-  Easy-order – place several items in your basket at the same time
-  Quick Item search – no login needed





heating elements

heating elements for pasta cookers

			
1			
GEV No.	415020	Ref. No.	110331 H110331
description	heating element 4500W 230V mounting \varnothing 57.5mm heating circuits 3 L 355mm W 35mm H 47mm number of thermostat sleeves 1 thermostat sleeves \varnothing 7mm length thermostat sleeves 295mm thermostat sleeve upper tube \varnothing 8.5mm hole distance 70mm hole \varnothing 10mm connection length 25mm connection male faston 6.3mm 3 hole flange immersion heater		
For models:	HT100, HT150, HTP195, HTP205, HTP220		



coil heating elements

			
1			
GEV No.	418823	Ref. No.	110704 H110704
description	heating element 1000W 230V L 405mm W 50mm H 25mm tube \varnothing 8.5mm thread M14x1.5 connection M5 heating circuits 1		
For models:	HG2LR, HGLR, HT100, HT150, HTP195, HTP205, HTP220		

			
1			
GEV No.	418824	Ref. No.	H110706
description	heating element 1500W 230V L 428mm W 50mm H 25mm tube \varnothing 8.5mm thread M14x1.5 connection M6 connection length 41mm heating circuits 1 2 hole fixing		
For models:	EDT100, EDT140, EDT170, EDT200, EDT230, EDT85, TR-E100, TR-E150, TR-E170, TR-E200, TR-E230, TR-E90		

immersion heating elements

3 hole flange \varnothing 38.5mm



			
1			
GEV No.	415276	Ref. No.	25353 25360
description	heating element 2400W 230V mounting \varnothing 38.5mm heating circuits 2 L 297mm W 34mm H 34mm tube \varnothing 6.3mm hole distance 57mm hole \varnothing 10mm 3 hole flange connection male faston 6.3mm immersion heater		
For models:	C3, C4, CM43, CMD43, E40, E43, NK43, NKD43, T3-80		
accessories for	415276		
	GEV No.	532577	Ref. No.
			—
	 O-ring EPDM thickness 5.34mm ID \varnothing 40.65mm Qty 1 pcs		

Зип Общепит

vsezip.ru

+7(812)987-08-81

			
1			
GEV No.	415149	Ref. No.	30008
description	heating element 2800W 230V mounting \varnothing 38.5mm heating circuits 2 L 300mm W 21mm H 35mm number of thermostat sleeves 1 thermostat sleeves \varnothing 6.5mm length thermostat sleeves 53mm thermostat sleeve not clinging tube \varnothing 6.3mm hole distance 57mm hole \varnothing 10mm 3 hole flange connection male faston 6.3mm immersion heater		
For models:	C35, C43, C43ALTA, C43D, C48, C48D, C48DDL, C48DL, CR43, CR43D, CR48, CR48D, DP35, DP35D, DP40, DP40D, DP45, DP45D, DP50, DP50D, GS-X1011, GS-X1011-WEH, GS-X1021, GS-X1021-WEH, SP35, SP35ALTA, SP35D, SP40, SP40D, SP40DDL, SP40DL, SPR36, SPR36D, SPR41, SPR41D, STS43, STS43D, STS48, STS48D, STS53, STS53D, STS60, STS60D		
accessories for	415149		
	GEV No.	532577	Ref. No.
			—
	 O-ring EPDM thickness 5.34mm ID \varnothing 40.65mm Qty 1 pcs		

			
1			
GEV No.	415167	Ref. No.	25356
description	heating element 3000W 230V mounting \varnothing 38.5mm heating circuits 2 L 300mm W 21mm H 35mm number of thermostat sleeves 1 thermostat sleeves \varnothing 6.5mm length thermostat sleeves 53mm thermostat sleeve not clinging tube \varnothing 6.3mm hole distance 57mm hole \varnothing 10mm 3 hole flange connection male faston 6.3mm immersion heater		
For models:	C35, C43ALTA, C48DDL, C48DL, C6, C6D, CR43, CR43D, CR48, CR48D, DP35, DP35D, DP35D-2, DP40, DP40D, DP45, DP45D, DP50, DP50D, E50, GS-X1011, GS-X1011-WEH, GS-X1021, GS-X1021-WEH, SP35ALTA, SP40DDL, SP40DL, SP5, SP5D, SPB35, SPR36, SPR36D, SPR41, SPR41D, STS43, STS43D, STS43D-2, STS48, STS48D, STS48D-2, STS53, STS53D, STS60, STS60D		
spare parts for	415167		
	GEV No.	521120	Ref. No.
			25249
	 O-ring EPDM thickness 5.34mm ID \varnothing 37.47mm Qty 1 pcs		
accessories for	415167		
	GEV No.	532577	Ref. No.
			—
	 O-ring EPDM thickness 5.34mm ID \varnothing 40.65mm Qty 1 pcs		



Зип-Общелит

vsezip.ru

+7(812)987-08-81

GEV No.	415199	Ref. No.	25357 25358
description	heating element 4000W 400V mounting \varnothing 38.5mm heating circuits 2 L 297mm W 33mm H 18mm number of thermostat sleeves thermostat sleeves \varnothing 6.5mm length thermostat sleeves 135mm thermostat sleeve centre not clinging tube \varnothing 6.5mm hole distance 57mm hole \varnothing 10mm 3 hole flange connection male faston 6.3mm immersion heater		
For models:	APS43, APS48, APS48B, APS53, APS60, APSE43, APSE48, APSE53, APSE60, BPN48, BPS43, BPS52, C53, C53D, C60, C60D, CM52, CM60, CMD52, CMD60, DP40, DP40D, DP45, DP45D, DP50, DP50D, FW35, FW40, FW40B, FW45, FW50, K80F, K80G, M60, NK52, NK60, NKD52, NKD60, RSP50, RSP50A, SP45, SP45D, SP50, SP50-400V, SP50-440V, SP50D, STS48, STS48D, STS53, STS53D...(Other models you can see in the webshop)		
accessories for	415199		
	GEV No.	532577	Ref. No. —
	O-ring EPDM thickness 5.34mm ID \varnothing 40.65mm Qty 1 pcs		

GEV No.	420356	Ref. No.	29655
description	heating element 5000W 230/400V mounting \varnothing 38.5mm heating circuits 2 L 305mm W 33mm H 27mm tube \varnothing 6.5mm hole distance 57mm hole \varnothing 10mm 3 hole flange connection male faston 6.3mm immersion heater		
For models:	APS43, APS48, APS48B, APS53, APS60, APSE43, APSE48, APSE53, APSE60, FW35, FW40, FW40B, FW45, FW50		

GEV No.	415277	Ref. No.	25361
description	heating element 6000W 230V mounting \varnothing 38.5mm heating circuits 3 L 360mm W 34mm H 55mm L1 35mm L2 70mm L3 255mm H1 27mm H2 28mm hole distance 57mm hole \varnothing 10mm tube \varnothing 6.3mm connection male faston 6.3mm immersion heater 3 hole flange		
For models:	ED650E, ED650S, ED700, ED900		
accessories for	415277		
	GEV No.	532577	Ref. No. —
	O-ring EPDM thickness 5.34mm ID \varnothing 40.65mm Qty 1 pcs		

GEV No.	416390	Ref. No.	35484
description	heating element 3200W 230V mounting \varnothing 47.5mm heating circuits 2 L 302mm W 37mm H 20mm tube \varnothing 6.3mm hole distance 63mm hole \varnothing 8/10mm connection length 10mm connection male faston 6.3mm 3 hole flange immersion heater		
For models:	C35, C35E, C43-2, C43DE, C43E, C46DE, C46E, C48-2, C48D-2, C48E, CDN3, CDN4, DP35-2, DP40-2, DP40D-2, DP40D-rib2, DP40-rib2, GS-X1011-2, GS-X1011-WEH-2, GS-X1021-2, GS-X1021-2rib, GS-X1021-WEH-2, GS-X1021-WEH-2rib, RSP40, RSP40A, SP35-2, SP35DE, SP35E, SP40-2, SP40D-2, SP40DE, SP40E, SPB35, SPB35E, ST43DE, ST43E, ST48DE, ST48E, STS43-2, STS43D-2, STS48-2, STS48D-2, STS48D-rib2, STS48-rib2, TDN4-2rib		
accessories for	416390		
	GEV No.	510408	Ref. No. 200820 8662
	O-ring EPDM thickness 5.34mm ID \varnothing 47mm Qty 1 pcs		
	GEV No.	510562	Ref. No. —
	O-ring silicone thickness 5.34mm ID \varnothing 47mm Qty 1 pcs		

GEV No.	416274	Ref. No.	H110398
description	heating element 5000W 230V mounting \varnothing 47.5mm heating circuits 3 L 248mm W 36mm H 34mm number of thermostat sleeves 1 thermostat sleeves \varnothing 7mm length thermostat sleeves 200mm thermostat sleeve eccentric, non clinging tube \varnothing 6.5mm hole distance 64mm hole \varnothing 8mm connection M4 3 hole flange immersion heater		
spare parts for	416274		
	GEV No.	510408	Ref. No. 200820 8662
	O-ring EPDM thickness 5.34mm ID \varnothing 47mm Qty 1 pcs		
accessories for	416274		
	GEV No.	510562	Ref. No. —
	O-ring silicone thickness 5.34mm ID \varnothing 47mm Qty 1 pcs		



Зип Общепит

vsezip.ru

+7(812)987-08-81



1

GEV No.	416273	Ref. No.	110397 H110397
description	heating element 3200W 230V mounting \varnothing 42mm heating circuits 1 L 237mm W 35mm H 38mm number of thermostat sleeves 1 thermostat sleeves \varnothing 7mm length thermostat sleeves 200mm thermostat sleeve not clinging tube \varnothing 6.3mm hole distance 66mm hole \varnothing 8mm connection length 26mm connection male faston 6.3mm 3 hole flange immersion heater		
For models:	DP40D-2, STS48D-2		
accessories for	416273		
	GEV No.	510408	Ref. No. 200820 8662
	O-ring EPDM thickness 5.34mm ID \varnothing 47mm Qty 1 pcs		
	GEV No.	510562	Ref. No. —
	O-ring silicone thickness 5.34mm ID \varnothing 47mm Qty 1 pcs		



1

GEV No.	415023	Ref. No.	110367 H110367
description	heating element 12500W 230V mounting \varnothing 57.5mm heating circuits 3 L 630mm W 36mm H 48mm number of thermostat sleeves 1 thermostat sleeves \varnothing 7mm length thermostat sleeves 295mm thermostat sleeve eccentric, non clinging tube \varnothing 8.5mm hole distance 76mm hole \varnothing 8x10mm connection M5 3 hole flange immersion heater		
For models:	EDT100, EDT140, EDT170, EDT200, EDT230, EDT85, HT100, HT150, HTP195, HTP205, HTP220, TR100, TR90, TR-E100, TR-E90		
spare parts for	415023		
	GEV No.	510409	Ref. No. 200815 33402 H200815
	O-ring EPDM thickness 5.34mm ID \varnothing 56.52mm Qty 1 pcs		

3 hole flange \varnothing 57.5mm



1

GEV No.	418624	Ref. No.	110388 27298 H110388
description	heating element 10000W 230/400V mounting \varnothing 57.5mm heating circuits 3 L 480mm W 35mm H 43mm number of thermostat sleeves 1 thermostat sleeves \varnothing 7mm length thermostat sleeves 285mm tube \varnothing 8.5mm hole distance 72mm hole \varnothing 8mm immersion heater		
For models:	CA120, CA90, CAP10, CAP12, CAP12DE, CAP12EBT, CAP15EBT, CAP7E, ED650E, ED650E-90, ED650S, ED650S-90, EDT100, EDT140, EDT170, EDT200, EDT230, EDT85, HT100, HT150, HTP195, HTP205, HTP220, RCA1200, RCA1200i, SO120, SO55-400V3-50Hz-MARINE, TR140, TR200, TR230, TR-E170, TR-E200, TR-E230, TR-E90		
spare parts for	418624		
	GEV No.	510409	Ref. No. 200815 33402 H200815
	O-ring EPDM thickness 5.34mm ID \varnothing 56.52mm Qty 1 pcs		





1

GEV No.	415060	Ref. No.	H110363
description	heating element 3000W 230V mounting \varnothing 57.5mm heating circuits 1 L 330mm W 45mm H 29mm number of thermostat sleeves 1 thermostat sleeves \varnothing 7mm length thermostat sleeves 295mm thermostat sleeve not clinging tube \varnothing 6.25mm hole distance 73mm hole \varnothing 8mm connection male faston 6.3mm 3 hole flange immersion heater		
For models:	C6DE, C6E, SP5DE, SP5E		



1

GEV No.	419061	Ref. No.	110335 37008
description	heating element 4000W 230/400V mounting \varnothing 57.5mm heating circuits 3 L 295mm W 30mm H 42mm number of thermostat sleeves 1 thermostat sleeves \varnothing 7.5mm length thermostat sleeves 300mm thermostat sleeve eccentric, non clinging tube \varnothing 6.3mm hole distance 72mm hole \varnothing 8/10mm connection length 22mm connection M4 3 hole flange immersion heater		
For models:	C53DE, C53E, C60DE, C60E, CAP12EBT, DP45DE, DP45E, DP50DE, DP50E, EDI4, HD40ALTABT, HD40BT, LO56, SO100-400V3-50Hz-MARINE, SO100-440V3-60Hz-MARINE, SP45DE, SP45E, SP50DE, SP50E, ST53DE, ST53E, ST60DE, ST60E		
accessories for	419061		
	GEV No.	510409	Ref. No. 200815 33402 H200815
	O-ring EPDM thickness 5.34mm ID \varnothing 56.52mm Qty 1 pcs		



1

GEV No.	417403	Ref. No.	H110385
description	heating element 12000/14000W 240-415V heating circuits 3 L 620mm W 37mm H 51mm number of thermostat sleeves 1 thermostat sleeves \varnothing 8.8mm length thermostat sleeves 290mm tube \varnothing 10mm hole distance 73mm hole \varnothing 8mm		
For models:	EDT100, EDT140, EDT170, EDT200, EDT230, EDT85		



electric components





Зип Общепит

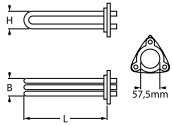

vsezip.ru

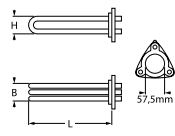
+7(812)987-08-81

			
			
1			
GEV No.	419062	Ref. No.	36250
description	heating element 4000W 230V mounting \varnothing 57.5mm heating circuits 3 L 300mm W 37mm H 50mm number of thermostat sleeves 1 thermostat sleeves \varnothing 7.5mm length thermostat sleeves 295mm thermostat sleeve eccentric, non clinging tube \varnothing 8.5mm hole distance 72mm hole \varnothing 8/10mm connection length 22mm connection M5 3 hole flange immersion heater		
For models:	C53DE, C53E, C60DE, C60E, CAP10, CAP10BT, CAP10DE, CAP12, CAP12DE, SO100, SO100-400V3-50Hz-MARINE, SO100-440V3-60Hz-MARINE, SO120, SP45DE, SP45E, SP50DE, SP50E		
accessories for	419062		
	GEV No.	510409	Ref. No. 200815 33402 H200815
O-ring EPDM thickness 5.34mm ID \varnothing 56.52mm Qty 1 pcs			

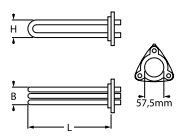
			
			
1			
GEV No.	415021	Ref. No.	110249 31007 33400 H110249
description	heating element 6000W 230V mounting \varnothing 57.5mm heating circuits 3 L 343mm W 37mm H 50mm number of thermostat sleeves 1 thermostat sleeves \varnothing 7mm length thermostat sleeves 294mm thermostat sleeve not clinging tube \varnothing 8.5mm hole distance 72mm hole \varnothing 8mm connection M5 3 hole flange		
For models:	AP53E, AP60E, APS60, C68DE, C68E, C81, C81E, C81EBT, C90, C90DE, C90DE2, C90E, C90E2, C90EBT2, C98, CA120, CA55, CA90, CAP10, CAP10BT, CAP10DE, CAP7, CAP7E, ED550, ED600-95, ED630-90, ED650E, ED650E-90, ED650S, ED650S-90, ED700-90, ED900-90, EDI13, EDI13-2, EDI13ALTA, EDI13ALTA-2, EDI13ALTABT, EDI13BT, EDI4, EDI5, EDI6, EDI6-2, EDI6BT, EDI8, EDI8-2, EDI8BT, FW50, HD130BT, HD40AL-TABT, HD40BT...(Other models you can see in the webshop)		
accessories for	415021		
	GEV No.	550002	Ref. No. —
tension strap H 10mm L 21mm W 10mm hole \varnothing 6.5mm for heating element			

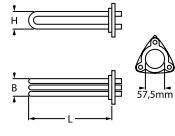
			
			
1			
GEV No.	415020	Ref. No.	110331 H110331
description	heating element 4500W 230V mounting \varnothing 57.5mm heating circuits 3 L 355mm W 35mm H 47mm number of thermostat sleeves 1 thermostat sleeves \varnothing 7mm length thermostat sleeves 295mm thermostat sleeve upper tube \varnothing 8.5mm hole distance 70mm hole \varnothing 10mm connection length 25mm connection male faston 6.3mm 3 hole flange immersion heater		
For models:	HT100, HT150, HTP195, HTP205, HTP220		

			
			
1			
GEV No.	415670	Ref. No.	110343 H110343
description	heating element 8000W 230V mounting \varnothing 57.5mm heating circuits 3 L 480mm W 40mm H 50mm number of thermostat sleeves 1 thermostat sleeves \varnothing 7mm length thermostat sleeves 295mm thermostat sleeve not clinging tube \varnothing 10mm hole distance 72mm hole \varnothing 8mm connection M5 3 hole flange immersion heater		
For models:	EDT100, EDT140, EDT170, EDT200, EDT230, EDT85, HG2LR, HGLR, HT100, HT150, HTP195, HTP205, HTP220, TR140, TR-E170, TR-E90		
spare parts for	415670		
	GEV No.	510409	Ref. No. 200815 33402 H200815
O-ring EPDM thickness 5.34mm ID \varnothing 56.52mm Qty 1 pcs			

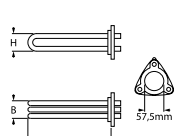
			
			
1			
GEV No.	420091	Ref. No.	110383 H110383
description	heating element 5000/6000W 240/415V mounting \varnothing 57.5mm heating circuits 3 L 405mm W 36mm H 41mm number of thermostat sleeves 1 thermostat sleeves \varnothing 7.5mm length thermostat sleeves 280mm tube \varnothing 8.3mm hole distance 73mm hole \varnothing 10mm connection M5 immersion heater		
For models:	60BT, 60BT-3, 60EBT, C68EBT, C6EBT, DP50EBT, EDT100, EDT140, EDT170, EDT200, EDT230, EDT85, SD5BT, ST48EBT, ST60EBT		

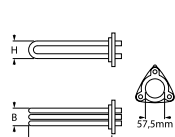

			
			
1			
GEV No.	417633	Ref. No.	110365 H110365
description	heating element 8000W 240/415V mounting \varnothing 57.5mm heating circuits 3 L 400mm W 35mm H 46mm number of thermostat sleeves 1 thermostat sleeves \varnothing 7.5mm length thermostat sleeves 290mm thermostat sleeve upper centre not clinging tube \varnothing 10mm hole distance 73mm		
For models:	EDT100, EDT140, EDT170, EDT200, EDT230, EDT85		







Зип Общепит

vsezip.ru

+7(812)987-09-81



			
GEV No.	415022	Ref. No.	100362 H110362
description	heating element 9000W 230/400V mounting ϕ 57.5mm heating circuits 3 L 475mm W 36mm H 43mm number of thermostat sleeves 1 thermostat sleeves ϕ 7mm length thermostat sleeves 300mm thermostat sleeve eccentric, non clinging tube ϕ 10mm hole distance 73mm hole ϕ 10mm connection length 30mm connection M5 3 hole flange immersion heater		
For models:	C90EBT, CAP10BT, EDI13, EDI13-2, EDI13ALTA, EDI13ALTA-2, EDI8, EDI8-2, EDT100, EDT140, EDT170, EDT200, EDT230, EDT85, LO134, LO134-2, LO134ALTA, LO134ALTA-2, LO83, LO83-2, RLO300, RLO400, TR100, TR140, TR170, TR200, TR230, TR90, TR-E100, TR-E150, TR-E170, TR-E200, TR-E230, TR-E90		
spare parts for	415022		
		GEV No.	510409 Ref. No. 200815 33402 H200815
O-ring EPDM thickness 5.34mm ID ϕ 56.52mm Qty 1 pcs			

			
GEV No.	415196	Ref. No.	25370
description	heating element 2000W 230V / heating circuits 2 thread 1" L 305mm W 34mm H 45mm H1 22mm H2 23mm tube ϕ 6.3mm connection male faston 6.3mm immersion heater flange with thread WS 30		
For models:	CM52, CM60, CMD52, CMD60, K80F, K80G, M60, NK60, NKD60, T5-80, T6-80		
accessories for	415196		
		GEV No.	510404 Ref. No. —
flat gasket fibre ED ϕ 44mm ID ϕ 34mm thickness 2mm Qty 1 pcs			
		GEV No.	510422 Ref. No. —
gasket copper ED ϕ 37.7mm ID ϕ 32.5mm thickness 2.7mm for thread 1"			
		GEV No.	520233 Ref. No. —
nut thread 1" H 6mm brass WS 47 Qty 1 pcs			

3 hole flange ϕ60.0mm			
connection straight			
group 2			
			
GEV No.	420342	Ref. No.	110386 H110386
description	heating element 14000W 230/400V mounting ϕ 60mm heating circuits 3 L 620mm W 33mm H 49mm number of thermostat sleeves 1 thermostat sleeves ϕ 7.5mm length thermostat sleeves 290mm thermostat sleeve eccentric, non clinging tube ϕ 10mm hole distance 83mm hole ϕ 10mm connection M5 3 hole flange immersion heater		
For models:	EDT100, EDT140, EDT170, EDT200, EDT230, EDT85, TR100, TR90, TR-E100, TR-E90		

			
GEV No.	418902	Ref. No.	110269 35230
description	heating element 2000W 230V heating circuits 1 L 300mm W 140mm H 28mm thread M12x1 mounting distance 70mm tube ϕ 6.3mm connection male faston 6.3mm 2 hole fixing connection length 35mm immersion heater		
For models:	C35, C35E, C43-2, C43ALTA, C43DE, C43E, C46DE, C46E, C48-2, C48D-2, C48DDL, C48DL, C48E, C53, C53D, C60, C60D, CDN3, CDN4, DP35, DP35-2, DP35D, DP35D-2, DP40, DP40-2, DP40D, DP40D-2, DP40D-rib2, DP40-rib2, DP45, DP45D, DP50, DP50D, GS-X1011, GS-X1011-2, GS-X1011-WEH, GS-X1011-WEH-2, GS-X1021, GS-X1021-2, GS-X1021-2rib, GS-X1021-WEH, GS-X1021-WEH-2, GS-X1021-WEH-2rib, RSP40, RSP40A, SP35-2, SP35ALTA, SP35DE, SP35E, SP40-2...(Other models you can see in the webshop)		

with expansion flange 70 x 18mm			
			
GEV No.	415016	Ref. No.	33339
description	heating element 3000W 230V heating circuits 3 flange 70x18mm L 398mm W 60mm H 24mm connection male faston 6.3mm immersion heater expansion flange tube ϕ 6.3mm		
For models:	C81, C81E, C81EBT, C90, C90DE, C90E, C90EBT, C98, CA120, CA55, CA90, CAP7, CAP7E, ED550, ED650E, ED650S, LO50, LO50E, LO62, RCA1100, RCA1200, RCA1200i, RLO50, SMW15, SMW15E, SO55, SO55-400V3-50Hz-MARINE, SO55E, SP81, SP81E, US-X501		

			
GEV No.	415198	Ref. No.	30443 31380 35162
description	heating element 2000W 230V heating circuits 1 L 318mm W 85mm H 26mm thread M12x1 mounting distance 77mm tube ϕ 8.3mm connection male faston 6.3mm 2 hole fixing immersion heater		
For models:	60BT, 60BT-3, 60EBT, C3, C35, C4, C43, C43ALTA, C43D, C48, C48D, C48DDL, C48DL, C53, C53D, C53DE, C53E, C6, C60, C60D, C60DE, C60E, C68DE, C68E, C68EBT, C6D, C6DE, C6E, C6EBT, CDN3, CDN4, CR43, CR43D, CR48, CR48D, DP35, DP35D, DP40, DP40D, DP45, DP45D, DP45DE, DP45E, DP50, DP50D, DP50DE, DP50E, DP50EBT, E40-2F, GS-X1011...(Other models you can see in the webshop)		
accessories for	415198		
		GEV No.	520229 Ref. No. —
nut thread M12x1 H 4mm WS 16 zinc-coated steel Qty 1 pcs			
		GEV No.	521110 Ref. No. —
flat gasket fibre ED ϕ 20mm ID ϕ 13mm thickness 2mm Qty 1 pcs			

electric components



foil heating elements



GEV No.	419007	Ref. No.	H110285
description	foil heating element L 380mm W 73mm 500W 230V t.max. 140°C with temperature limiter 140°C silicone cable length 200mm thickness 1mm connection male faston 6.3mm		
For models:	AP53E, AP60E		

thermostats

bi-metal thermostats

safety bi-metal thermostats

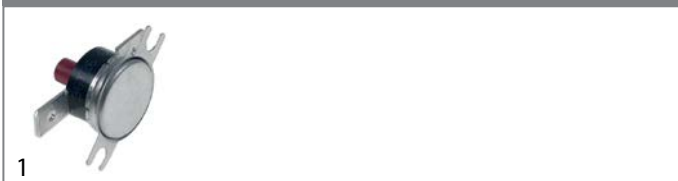

GEV No.	390748	Ref. No.	36348
description	bi-metal safety thermostat hole distance 23.5mm switch-off temp. 100°C 1NC 1-poleA connection F6.3		
For models:	C35E, C81E, C81EBT, C90DE, C90E, C90EBT, C98, CAP7, CAP7E, LO50E, LO62, SO55, SO55-440V3-60Hz-MARINE, SO55E, SP81E, SPB35E		



GEV No.	390916	Ref. No.	35837
description	bi-metal safety thermostat hole distance mm switch-off temp. 68°C 1NC 16A connection F6.3 mounting ø 16mm		
For models:	C81E, C90E, C98, CAP7, LO50E, LO62, SO55, SO55-400V3-50Hz-MARINE, SO55-440V3-60Hz-MARINE, SP81E		

Зип-Общепит

bi-metal thermostats

vsezip.ru

+7(812)987-08-81

GEV No.	390025	Ref. No.	120524 33948
description	bi-metal thermostat hole distance 40mm switch-off temp. 55/42°C NC/NO 2-pole 16A 250V connection F6.3 2 hole fixing		
For models:	60BT, 60BT-3, C35, C35E, C43, C43-2, C43ALTA, C43D, C43DE, C43E, C46DE, C46E, C48, C48-2, C48D, C48D-2, C48DDL, C48DL, C48E, C53, C53D, C6, C60, C60D, C6D, CDN3, CDN4, CR43, CR43D, CR48, CR48D, DP35, DP35-2, DP35D, DP35D-2, DP40, DP40-2, DP40D, DP40D-2, DP40D-rib2, DP40-rib2, DP45, DP45D, DP50, DP50D, DP50D-115V, GS-X1011, GS-X1011-2, GS-X1011-WEH, GS-X1011-WEH-2...(Other models you can see in the webshop)		
accessories for	390025		
	GEV No.	512154	Ref. No. H200494
	gasket for thermostat ID ø 20mm equiv. no. 200494/H200494 hole distance 41mm suitable for COMENDA, HOONVED		

control and safety thermostats

IMIT / TEMPOMATIC / ARATHERMO

control thermostats



GEV No.	390914	Ref. No.	120515
description	bi-metal thermostat t.max. 90°C temperature range 0-90°C 1-pole 1CO 10A probe ø 6.5mm probe L 97mm capillary pipe 1000mm capillary pipe isolated 950mm gland nut shaft ø 6x4.6mm shaft L 12mm shaft position upper rotation 270° with housing 250V		
For models:	HG2LR, HGLR		



GEV No.	390193	Ref. No.	25421
description	thermostat t.max. 56°C temperature range 0-90°C 1-pole 1CO 16A probe ø 6.5mm probe L 95mm capillary pipe 1500mm capillary pipe isolated 1500mm gland nut shaft ø mm shaft L mm shaft position rotation 270° probe material copper		
For models:	C3, C4, CM48, CM52, CM60, CMD43, CMD52, DP35, DP35D, DP40, DP40D, DP45, DP45D, DP50, DP50D, E40-2F, K80F, K80G, NK52, NK60, STS43, STS43D, STS48, STS48D, STS53, STS53D, STS60, STS60D, T5-80, T6-80, TS48, UNI43C, UNI48C, UNI48CD, UNI53C, UNI53R, UNI53RD, UNI60C		





Зип Общепит

vsezip.ru

81(2)987-08-81

			
GEV No.	390014	Ref. No.	120525 H120525
description	thermostat t.max. 85°C temperature range 40-78 / 47-85°C 2-pole 2CO 16A probe ø 6.5mm probe L 95mm capillary pipe 1500mm capillary pipe isolated 1450mm gland nut shaft ø 6x4.6mm shaft L 15mm shaft position right rotation 270°		
For models:	60BT, 60BT-3, 60EBT, C35E, C43DE, C43E, C46DE, C46E, C48E, C53DE, C53E, C60DE, C60E, C68DE, C68E, C68EBT, C6DE, C6E, C6EBT, CAP7, CAP7E, DP45DE, DP45E, DP50DE, DP50E, GS-X1011, GS-X1011-2, GS-X1011-WEH, GS-X1011-WEH-2, GS-X1021, GS-X1021-2, GS-X1021-2rib, GS-X1021-WEH, GS-X1021-WEH-2, GS-X1021-WEH-2rib, SD5BT, SO55, SO55-400V3-50Hz-MARINE, SO55-440V3-60Hz-MARINE, SO55E, SP35DE, SP35E, SP40DE, SP40E, SP45DE, SP45E, SP50DE, SP50E, SP50E-400V3-50Hz-MARINE, SP50E-440V3-60Hz-MARINE...(Other models you can see in the webshop)		

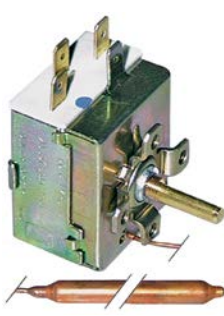
			
GEV No.	390022	Ref. No.	120522 H120522
description	thermostat t.max. 90°C temperature range 30-90°C 1-pole 1CO 16A probe ø 9.5mm probe L 50mm capillary pipe 1000mm capillary pipe isolated 1000mm gland nut shaft L 19mm rotation 270°		
For models:	60EBT, C53DE, C53E, C60DE, C60E, C68DE, C68E, C68EBT, C6DE, C6E, C6EBT, DP45DE, DP45E, DP50DE, DP50E, DP50EBT, SP45DE, SP45E, SP50DE, SP50E, SP50E-400V3-50Hz-MARINE, SP50E-440V3-60Hz-MARINE, SP50E, SP5E, SP68DE, SP68E, ST53DE, ST53E, ST60DE, ST60E, ST60EBT		

			
GEV No.	390006	Ref. No.	H120501
description	thermostat t.max. 86°C temperature range 0-86°C 1-pole 1CO 16A probe ø 6.5mm probe L 95mm capillary pipe 1500mm capillary pipe isolatedmm gland nut shaft ø 6x4.6mm shaft L 19mm rotation 270°		
For models:	EDT100, EDT140, EDT170, EDT200, EDT230, EDT85, TR100, TR140, TR170, TR200, TR230, TR90, TR-E100, TR-E150, TR-E170, TR-E200, TR-E230, TR-E90		
accessories for	390006		
	GEV No.	110100	Ref. No. —
	knob thermostat t.max. 90°C 0-90°C ø 42mm shaft ø 6x4.6mm shaft flat -135° black		
	GEV No.	110105	Ref. No. 191040 H191040
	rosette knob ø 42mm ø 56mm zero mark		

			
GEV No.	390736	Ref. No.	120525/1 38071
description	thermostat temperature range 37-76 / 46-85°C 2-pole 2CO 16A probe ø 6.5mm probe L 84mm capillary pipe 920mm capillary pipe isolated 845mm shaft ø 6x5mm shaft L 15mm rotation 90°		
For models:	60EBT, C35E, C43DE, C43E, C46DE, C46E, C53DE, C53E, C60DE, C60E, C68DE, C68E, C68EBT, C6DE, C6E, C6EBT, CAP7E, DP45DE, DP45E, DP50DE, DP50E, DP50EBT, HD130BT, HD40ALTABT, HD40BT, HD60BT, HD80BT, SO55E, SP35DE, SP35E, SP40DE, SP40E, SP45DE, SP45E, SP50DE, SP50E, SPB35E, ST43DE, ST43E, ST48DE, ST48E, ST48EBT, ST53DE, ST53E, ST60DE, ST60E, ST60EBT		

			
GEV No.	390192	Ref. No.	25417
description	thermostat t.max. 90°C temperature range 0-90°C 1-pole 1CO 16A probe ø 6.5mm probe L 95mm capillary pipe 2000mm capillary pipe isolated 2000mm gland nut shaft ø 6x4.6mm shaft L 19mm shaft position upper rotation 270° probe material copper		
For models:	APS43, APS48, APS53, APS60, APSE43, APSE48, APSE53, APSE60, C3, C35, C4, C43, C43ALTA, C43D, C48, C48D, C48DDL, C48DL, C53, C53D, C60, C60D, C98, CA55, CAP7, CAP7E, CDN3, CDN4, CM43, CM48, CM52, CMD43, CMD48, CMD52, CMD60, CR43, CR43D, CR48, CR48D, DP35, DP35D, DP40, DP40D, DP45, DP45D, DP50, DP50D, DP50D-115V, E36, E40...(Other models you can see in the webshop)		

safety thermostats			
			
GEV No.	390773	Ref. No.	120519 H120519
description	safety thermostat switch-off temp. 135°C temperature range 95-135°C 1-pole 1CO 16A probe ø 5mm probe L 130mm capillary pipe 1000mm capillary pipe isolated 900mm gland nut probe		
For models:	AC101, AC151, AC181, AC201, AC241, AC91, CAP15EBT, EDT100, EDT140, EDT170, EDT200, EDT230, EDT85, HD130BT, HD40ALTABT, HD40BT, HD60BT, HD80BT, HT100, HT150, TR100, TR140, TR170, TR200, TR230, TR90, TR-E100, TR-E150, TR-E170, TR-E200, TR-E230, TR-E90		

electric components



Зип-Общепит

various

vsezip.ru

+7(812)987-08-81

RANCO

safety thermostats

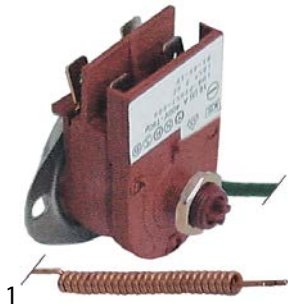

GEV No.	390473	Ref. No.	120536 33906
description	safety thermostat t.max. 105°C temperature range°C 2-pole 2NC 16A probe ø 6mm probe L 50mm capillary pipe 430mm capillary pipe isolated 310mm gland nut shaft ømm shaft Lmm shaft position rotation° probe material copper screw connection M10x0.75		
For models:	C35, C35E, C43, C43ALTA, C43D, C43DE, C43E, C46DE, C46E, C48, C48D, C48DDL, C48DL, C48E, C53, C53D, C60, C60D, C6DE, C6E, CDN3, CDN4, CR43, CR43D, CR48, CR48D, DP35, DP35D, DP40, DP40D, DP45, DP45D, DP50, DP50D, GS-X1011, GS-X1011-2, GS-X1011-WEH, GS-X1011-WEH-2, GS-X1021, GS-X1021-2, GS-X1021-2rib, GS-X1021-WEH, GS-X1021-WEH-2, GS-X1021-WEH-2rib, SP35, SP35ALTA, SP35D, SP35DE, SP35E, SP40...(Other models you can see in the webshop)		

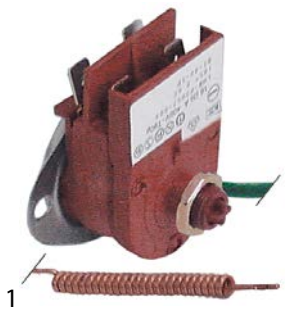

GEV No.	390469	Ref. No.	120526
description	safety thermostat t.max. 110°C temperature range°C 2-pole 2NC 16A probe ø 6mm probe L 50mm capillary pipe 1540mm capillary pipe isolated 160mm gland nut shaft ømm shaft Lmm shaft position rotation° probe material copper screw connection M10x0.75 switch-off temp. 110°C		

thermostats

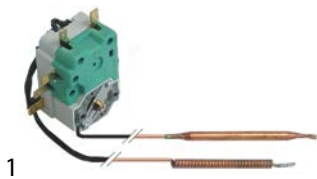

GEV No.	390474	Ref. No.	34534
description	thermostat t.max. 116°C capillary pipe isolatedmm gland nut 0-90°C		
For models:	C35, C43, C43-2, C43ALTA, C43D, C48, C48-2, C48D, C48D-2, C48DDL, C48DL, C53, C53D, C6, C60, C60D, C6D, CDN3, CDN4, CR43, CR43D, CR48, CR48D, DP35-2, DP35D-2, DP40-2, DP40D-2, DP40D-rib2, DP40-rib2, RSP40, RSP40A, SP35, SP35-2, SP35ALTA, SP35D, SP40, SP40-2, SP40D, SP40D-2, SP40DDL, SP40DL, SP45, SP45D, SP5, SP50, SP50-400V, SP50-440V, SP50D, SP5D, SPB35...(Other models you can see in the webshop)		

safety thermostats



GEV No.	390194	Ref. No.	33745
description	safety thermostat switch-off temp. 90-110°C 1-pole 16A probe ø 6.5mm probe L 87mm capillary pipe 1500mm capillary pipe isolated 1497mm connection male faston 6.3mm adjustable		
For models:	60BT, 60BT-3, 60EBT, AP43E, AP48E, AP53E, AP60E, APS43, APS48, APS48B, APS53, APS60, APSE43, APSE48, APSE53, APSE60, C43, C43ALTA, C43D, C48, C48D, C48DDL, C48DL, C53, C53D, C53DE, C53E, C60, C60D, C60DE, C60E, C68DE, C68E, C68EBT, C6EBT, C81, C81E, C81EBT, C90, C90DE, C90DE2, C90E, C90E2, C90EBT, C90EBT2, C98, CA120, CA55, CA90, CAP10...(Other models you can see in the webshop)		

accessories

plunger sockets



GEV No.	510935	Ref. No.	450515 H450515	
description	thermowell thread 1/2" L 107mm SS single ø 8mm			
accessories for	510935			
	GEV No.	361184	Ref. No.	—
	nut thread 1/2" H 6mm nickel-plated brass WS 24 Qty 1 pcs			
	GEV No.	521122	Ref. No.	—
	flat gasket fibre ED ø 31mm ID ø 21.5mm thickness 2mm for thread 1/2" Qty 1 pcs			



GEV No.	510986	Ref. No.	H450516	
description	thermowell thread 1/2" L 120mm SS double ø 6.5mm			
For models:	C90, C90DE, C90E, C90EBT, C98, CA120, CA55, CA90, CAP10, CAP10BT, CAP12, CAP7, CAP7E, ED550, ED650E, ED650S, EDI13, EDI13-2, EDI13ALTA, EDI13ALTA-2, EDI13ALTABT, EDI13BT, EDI6, EDI6-2, EDI6BT, EDI8, EDI8-2, EDI8BT, EDT100, EDT140, EDT170, EDT200, EDT230, EDT85, LO134, LO134-2, LO134ALTA, LO134ALTA-2, LO50, LO50E, LO62, LO67, LO67-2, LO83, LO83-2, RCA1100, RCA1200, RCA1200i, RLO200, RLO300...(Other models you can see in the webshop)			
accessories for	510986			
	GEV No.	361184	Ref. No.	—
	nut thread 1/2" H 6mm nickel-plated brass WS 24 Qty 1 pcs			
	GEV No.	521122	Ref. No.	—
	flat gasket fibre ED ø 31mm ID ø 21.5mm thickness 2mm for thread 1/2" Qty 1 pcs			



Зип Общепит
vsezip.ru
+7(812)987-08-81

miscellaneous

1 

GEV No.	501353	Ref. No.	200491 H200491
description	gasket for thermostat hole ø 6.6mm L 98mm W 68mm thickness 2mm		
For models:	AC101, AC151, AC181, AC201, AC241, AC91, EDT100, EDT140, EDT170, EDT200, EDT230, EDT85, TR100, TR140, TR170, TR200, TR230, TR90, TR-E100, TR-E150, TR-E170, TR-E200, TR-E230, TR-E90		

1 

GEV No.	345846	Ref. No.	130459 H130459
description	momentary push switch mounting measurements 28.5x28.5mm grey 2CO 250V 16A START connection male faston 6.3mm ambient temperature max. 150°C protection IP40		

switches and momentary switches

rocker/momentary rocker switches

27.8x25mm

1 

GEV No.	345000 ¹	Ref. No.	130421 H130421
description	momentary rocker switch mounting measurements 27.8x25mm orange 2CO 250V 16A illuminated START connection male faston 6.3mm ambient temperature max. 85°C protection IP40 2-pole male faston 6.3mm		

¹illuminated

1 

GEV No.	347455	Ref. No.	36937
description	push switch mounting measurements 28.5x28.5mm green/red 2CO 250V 16A main switch connection male faston 6.3mm ambient temperature max. 150°C protection IP40 with indicator		
For models:	C43DE, C43E, C46DE, C46E, C53DE, C53E, C60DE, C60E, C68DE, C68E, C6DE, C6E, SP35DE, SP35E, SP40DE, SP40E, SP45DE, SP45E, SP50DE, SP50E, SP50E-400V3-50Hz-MARINE, SP50E-440V3-60Hz-MARINE, SP5DE, SP5E, SP68DE, SP68E		

1 

GEV No.	510281	Ref. No.	H160733
description	blank black mounting measurements 27.8x25mm		

1 

GEV No.	347492	Ref. No.	36489
description	push switch mounting measurements 28.5x28.5mm green/red 2CO 250V 16A main switch connection male faston 6.3mm ambient temperature max. 150°C protection IP40 with indicator		
For models:	60EBT, C43DE, C43E, C46DE, C46E, C53DE, C53E, C60DE, C60E, C68DE, C68E, C68EBT, C6DE, C6E, C6EBT, SP35DE, SP35E, SP40DE, SP40E, SP45DE, SP45E, SP50DE, SP50E, SP5DE, SP5E, SP68DE, SP68E		

push/momentary push switches

28.5x28.5mm

1 

GEV No.	345928	Ref. No.	31185
description	momentary push switch mounting measurements 28.5x28.5mm grey 2NO 250V 16A connection male faston 6.3mm ambient temperature max. 150°C protection IP40		
For models:	BPN48, BPS43, BPS52, INDY43F, INDY48F, INDY53F, INDY60F		

1 

GEV No.	345845	Ref. No.	130460 H130460
description	push switch mounting measurements 28.5x28.5mm green/red 2CO 250V 16A ON-OFF connection male faston 6.3mm ambient temperature max. 150°C protection IP40		

1 

GEV No.	345227	Ref. No.	29009
description	push switch mounting measurements 28.5x28.5mm red/green 1CO 250V 16A connection male faston 6.3mm ambient temperature max. 150°C protection IP40 with indicator		
For models:	BPN48, BPS43, BPS52, CM48, CM52, CMD43, CMD52, INDY43F, INDY48F, INDY53F, INDY60F, TS43, TS48, UNI43C, UNI43R, UNI43RD, UNI48C, UNI48CD, UNI48R, UNI48RD, UNI53C, UNI53R, UNI53RD, UNI60C		

1 

GEV No.	345939	Ref. No.	34624 35336
description	momentary push switch mounting measurements 28.5x28.5mm black 1NO 250V 16A outflow connection male faston 6.3mm ambient temperature max. 150°C protection IP40		
For models:	60BT, 60BT-3, RSP50, RSP50A, SD5BT, VS-X313, VS-X313-LP-DOS, VS-X515, VS-X515-LP-DOS		

Зип-Общепит
accessoriespush buttons
vsezip.ru

+7(812)987-08-81



1

GEV No.	347933	Ref. No.	34623
description	momentary push switch mounting measurements 28.5x28.5mm black 1NO 250V 16A START connection male faston 6.3mm ambient temperature max. 150°C		
For models:	60BT, 60BT-3, C98, EDI5, GS-X1011, GS-X1011-2, GS-X1011-WEH, GS-X1011-WEH-2, GS-X1021, GS-X1021-2, GS-X1021-2rib, GS-X1021-WEH, GS-X1021-WEH-2, GS-X1021-WEH-2rib, LO61, LO62, SD5BT, VS-X313, VS-X313-LP-DOS, VS-X515, VS-X515-LP-DOS		



1

GEV No.	345929	Ref. No.	34622
description	push switch mounting measurements 28.5x28.5mm black 2CO 250V 16A main switch connection male faston 6.3mm ambient temperature max. 150°C protection IP40		
For models:	60BT, 60BT-3, CA55, CAP7, ED550, GS-X1011, GS-X1011-2, GS-X1011-WEH, GS-X1011-WEH-2, GS-X1021, GS-X1021-2, GS-X1021-2rib, GS-X1021-WEH, GS-X1021-WEH-2, GS-X1021-WEH-2rib, SD5BT, SO55, SO55-400V3-50Hz-MARINE, SO55-440V3-60Hz-MARINE, VS-X313, VS-X313-LP-DOS, VS-X515, VS-X515-LP-DOS		



1

GEV No.	345925	Ref. No.	28785
description	push switch mounting measurements 28.5x28.5mm blue/green 1CO 250V 16A rinsing connection male faston 6.3mm ambient temperature max. 150°C protection IP40 with indicator		
For models:	CM43, CM48, CMD43, CMD48, CMD52, CMD60, E36, E40, E40-2F, E43, ED650E, ED650E-90, K80F, K80G, NK43, NK48, NKD43, NKD52, NKD60, T3-80, T4-80, T5-80		



1

GEV No.	345924	Ref. No.	28784
description	push switch mounting measurements 28.5x28.5mm green/red 1CO 250V 16A main switch connection male faston 6.3mm ambient temperature max. 150°C protection IP40 with indicator green/red		
For models:	CM43, CM48, K80F, K80G, NK43, NK48, T3-80, T4-80, T5-80		



1

GEV No.	345143	Ref. No.	28786
description	push switch mounting measurements 28.5x28.5mm green/red 2CO 250V 16A main switch connection male faston 6.3mm ambient temperature max. 150°C protection IP40 with indicator		
For models:	CMD43, CMD48, CMD60, E36, E40, E40-2F, E43, E50, ED650E, ED650E-90, M60, NKD48, NKD52, NKD60		

1

GEV No.	110089	Ref. No.	32514
description	push button black		
For models:	UNI43C, UNI43R, UNI43RD, UNI48C, UNI48CD, UNI48R, UNI48RD, UNI53C, UNI53R, UNI53RD, UNI60C		

protective covers



1

GEV No.	524452	Ref. No.	25229
description	protection cap for switch L 145mm W 142mm H 120mm rubber		
For models:	ED600-95, ED700, ED700-90, ED900, ED900-90, LO122, LO60, LO78		

microswitches

lever actuated



1

GEV No.	345072	Ref. No.	H120329 H123328
description	microswitch with lever 250V 15A 2NO connection male faston 6.3mm L 42mm L1 44mm ambient temperature max. 85°C mounting distance 25mm type RM actuating force: 250g		

pin-plunger actuated

M10



1

GEV No.	347603	Ref. No.	25552
description	microswitch with plunger thread M10x0.75 thread L 10mm 250V 16A 1CO connection male faston 6.3mm stroke 5mm mounting distance 22mm L 29mm ambient temperature max. 125°C type VRSR01DZ2 actuating force: 170g		
For models:	BPN48, BPS43, BPS52, C3, C4, CM43, CM48, CM52, CM60, CMD43, CMD48, CMD52, CMD60, E36, E40, E40-2F, E43, ED650E, ED650E-90, ED650S-90, INDY43F, INDY48F, INDY53F, INDY60F, K80F, K80G, NK43, NK48, NK52, NK60, NKD43, NKD48, NKD52, NKD60, T3-80, T4-80, T5-80, TS43, TS48, UNI43C, UNI43R, UNI43RD, UNI48C, UNI48CD, UNI48R, UNI48RD, UNI53C, UNI53R, UNI53RD, UNI60C		



Зип Общежитие
system switches (ROLD)

vsezip.ru

+7(812)987-08-81

electric components

M12



1

GEV No.	345350	Ref. No.	25553
description	microswitch with plunger mounting distance 22mm thread M12x0.75 thread L 16mm 250V 16A 1CO connection male faston 6.3mm stroke 4mm ambient temperature max. 125°C type EF83161.3 actuating force: 66g		
For models:	BPN48, BPS43, BPS52, ED650S, ED700, ED900		
accessories for	345350		
	GEV No.	345351	Ref. No.
			—
	nut thread M12x0.75 H 1.6mm WS 14 chrome-plated brass Qty 1 pcs		

roller actuated

roller 0°



1

GEV No.	345923	Ref. No.	28843
description	microswitch with roller plunger 250V 16A 1CO connection screw ambient temperature max. 125°C thread L 14mm thread M12 mounting distance 25mm		
For models:	M60, T6-80		

position switches

PIZZATO

FD series



1

GEV No.	345075	Ref. No.	33435 870129 H870129
description	position switch cast aluminum 1NO/1NC 400V 3A L 141mm W 40mm H 35mm protection IP67 actuating force: 300g screw connection PG13.5 mounting distance 30x60mm type FD503		
For models:	CA120, CA55, CA90, CAP7, CAP7E, ED550, ED650E, ED650S, RCA1100, RCA1200, RCA1200i, SO55, SO55-400V3-50Hz-MARINE, SO55-440V3-60Hz-MARINE, SO55E		



1

GEV No.	345057	Ref. No.	120320 H120320
description	position switch cast aluminum 1NO/1NC 400V 3A L 98mm W 40mm H 35mm protection IP67 actuating force: 450g screw connection PG13.5 mounting distance 30x60mm		
For models:	AC101, AC151, AC181, AC201, AC241, AC91, EDT100, EDT140, EDT170, EDT200, EDT230, EDT85		

1

GEV No.	359244	Ref. No.	32916
description	blank ø 12.2mm grey (RAL7001)		
For models:	C3, C35, C4, C43, C43-2, C43ALTA, C43D, C48, C48-2, C48D, C48D-2, C48DDL, C48DL, C48E, C53, C53D, C6, C60, C60D, C81, CA120, CA90, CR43, CR43D, CR48, CR48D, ED650E, ED650S, SP35, SP35-2, SP35ALTA, SP35D, SP40, SP40-2, SP40D, SP40D-2, SP40DDL, SP40DL, SP40E, SP45, SP45D, SP5, SP50, SP50-400V, SP50-440V, SP50D, SP81, SPB35, SPR36, SPR36D...(Other models you can see in the webshop)		



1

GEV No.	359249	Ref. No.	32196
description	blank ø 12.2mm grey (RAL7015)		
For models:	APS60, APSE60, FW50		



1

GEV No.	345537	Ref. No.	37947
description	element holder mounting measurements 20.6x16.4mm grey arched for push buttons 13x17mm		
For models:	C35E, SPB35E		



1

GEV No.	345131	Ref. No.	190140 H190140
description	element holder mounting measurements 28.5x28.5mm grey single element holder		



1

GEV No.	359241	Ref. No.	33247
description	element holder mounting ø 16mm flat grey		
For models:	APS43, APS48, APS48B, APS53, APS60, APSE43, APSE48, APSE53, APSE60, C3, C35, C4, C43, C43-2, C43ALTA, C43D, C48, C48-2, C48D, C48D-2, C48DDL, C48DL, C48E, C53, C53D, C6, C60, C60D, C6D, C81, C90, CA120, CA90, CDN3, CDN4, CR43, CR43D, CR48, CR48D, DP35, DP35-2, DP35D, DP35D-2, DP40, DP40-2, DP40D, DP40D-2, DP40D-rib2, DP40-rib2, DP45...(Other models you can see in the webshop)		





Зип Общепит

vsezip.ru

+7(812)987-08-81

electric components

			
1			
GEV No.	345601	Ref. No.	32891
description	indicator lamp holder V ø 11mm		
For models:	APS43, APS48, APS48B, APS53, APS60, APSE43, APSE48, APSE53, APSE60, C3, C35, C4, C43, C43-2, C43ALTA, C43D, C48, C48-2, C48D, C48D-2, C48DDL, C48DL, C48E, C53, C53D, C6, C60, C60D, C6D, C81, C90, CA120, CA90, CDN3, CDN4, CR43, CR43D, CR48, CR48D, DP35, DP35-2, DP35D, DP35D-2, DP40, DP40-2, DP40D, DP40D-2, DP40D-rib2, DP40-rib2, DP45...(Other models you can see in the webshop)		

			
1			
GEV No.	359350	Ref. No.	34236
description	indicator light 230V blue connection male faston 6.3mm ø 11mm		
For models:	C35, C43, C43-2, C43ALTA, C43D, C48, C48-2, C48D, C48D-2, C48DDL, C48DL, C53, C53D, C6, C60, C60D, C6D, CDN3, CDN4, CR43, CR43D, CR48, CR48D, DP35, DP35-2, DP35D, DP35D-2, DP40, DP40-2, DP40D, DP40D-2, DP40D-rib2, DP40-rib2, DP45, DP45D, DP50, DP50D, SP35, SP35-2, SP35ALTA, SP35D, SP40, SP40-2, SP40D, SP40D-2, SP40DDL, SP40DL, SP45, SP45D, SP5...(Other models you can see in the webshop)		
accessories for	359350		
	GEV No.	345601	Ref. No.
			32891

			
1			
GEV No.	346808	Ref. No.	34198
description	indicator light lens ø 12.2mm blue		
For models:	C35, C43, C43-2, C43ALTA, C43D, C48, C48-2, C48D, C48D-2, C48DDL, C48DL, C53, C53D, C6, C60, C60D, C6D, CDN3, CDN4, CR43, CR43D, CR48, CR48D, DP35, DP35-2, DP35D, DP35D-2, DP40, DP40-2, DP40D, DP40D-2, DP40D-rib2, DP40-rib2, DP45, DP45D, DP50, DP50D, SP35, SP35-2, SP35ALTA, SP35D, SP40, SP40-2, SP40D, SP40D-2, SP40DDL, SP40DL, SP45, SP45D, SP5...(Other models you can see in the webshop)		

			
1			
GEV No.	359247	Ref. No.	32868
description	indicator light lens ø 12.2mm green		
For models:	APS43, APS48, APS48B, APS53, APS60, APSE43, APSE48, APSE53, APSE60, C3, C35, C4, C43, C43-2, C43ALTA, C43D, C48, C48-2, C48D, C48D-2, C48DDL, C48DL, C48E, C53, C53D, C6, C60, C60D, C6D, C81, C90, CA120, CA90, CR43, CR43D, CR48, CR48D, DP35, DP35-2, DP35D, DP35D-2, DP40, DP40-2, DP40D, DP40D-2, DP40D-rib2, DP40-rib2, DP45, DP45D, DP50, DP50D, ED650E, ED650S...(Other models you can see in the webshop)		

			
1			
GEV No.	359245	Ref. No.	32867
description	indicator light lens ø 12.2mm red		
For models:	APS43, APS48, APS48B, APS53, APS60, APSE43, APSE48, APSE53, APSE60, C3, C43ALTA, C43D, C48, C48D, C48DDL, C48DL, C53, C53D, C60, C60D, CR43, CR43D, CR48, CR48D, ED650E, ED650S, FW35, FW40, FW40B, FW45, FW50, SP35, SP35ALTA, SP35D, SP40, SP40D, SP40DDL, SP40DL, SP45, SP45D, SP50, SP50-400V, SP50-440V, SP50D, SPR36, SPR36D, SPR41, SPR41D		

			
1			
GEV No.	359246	Ref. No.	32869
description	indicator light lens ø 12.2mm yellow		
For models:	APS43, APS48, APS48B, APS53, APS60, APSE43, APSE48, APSE53, APSE60, C3, C35, C4, C43, C43-2, C43ALTA, C43D, C48, C48-2, C48D, C48D-2, C48DDL, C48DL, C48E, C53, C53D, C6, C60, C60D, C6D, C81, C90, CA120, CA90, CDN3, CDN4, CR43, CR43D, CR48, CR48D, DP35, DP35-2, DP35D, DP35D-2, DP40, DP40-2, DP40D, DP40D-2, DP40D-rib2, DP40-rib2, DP45...(Other models you can see in the webshop)		

			
1			
GEV No.	345130	Ref. No.	29529
description	momentary switch unit 1NO 250V 16A connection male faston 6.3mm		
For models:	APS43, APS48, APS48B, APS53, APS60, C3, C35, C4, C43, C43-2, C43ALTA, C43D, C48, C48-2, C48D, C48D-2, C48DDL, C48DL, C48E, C53, C53D, C6, C60, C60D, C6D, C81, CDN3, CDN4, CR43, CR43D, CR48, CR48D, DP35, DP35-2, DP35D, DP35D-2, DP40, DP40-2, DP40D, DP40D-2, DP40D-rib2, DP40-rib2, DP45, DP45D, DP50, DP50D, FW35, FW40, FW40B, FW45...(Other models you can see in the webshop)		

			
1			
GEV No.	347193	Ref. No.	H130449
description	momentary switch unit 1NO 250V 16A connection male faston 6.3mm		

			
1			
GEV No.	345606	Ref. No.	32870
description	momentary switch unit 2CO 250V 16A connection male faston 6.3mm		
For models:	APS43, APS48, APS53, APS60, APSE43, APSE48, APSE53, APSE60		





Зип Общепит

float switches

vsezip.ru

+7(812)987-08-81

			
1			
GEV No.	359243	Ref. No.	32390
description	push button ø 11.9mm grey		
For models:	APS43, APS48, APS48B, APS53, APS60, APSE43, APSE48, APSE53, APSE60, C35, C43, C43-2, C43ALTA, C43D, C48, C48-2, C48D, C48D-2, C48DDL, C48DL, C48E, C53, C53D, C6, C60, C60D, C6D, C81, CDN3, CDN4, CR43, CR43D, CR48, CR48D, DP35, DP35-2, DP35D, DP35D-2, DP40, DP40-2, DP40D, DP40D-2, DP40D-rib2, DP40-rib2, DP45, DP45D, DP50, DP50D, FW35, FW40...(Other models you can see in the webshop)		

			
1			
GEV No.	345539	Ref. No.	37946
description	push button size 17x13mm grey		
For models:	C35E, SPB35E		

			
1			
GEV No.	345719	Ref. No.	32872
description	switch 1CO 250V 16A connection male faston 6.3mm		
For models:	APS43, APS48, APS48B, APS53, APS60, APSE43, APSE48, APSE53, APSE60, C3, C35, C4, C43, C43-2, C43ALTA, C43D, C48, C48-2, C48D, C48D-2, C48DDL, C48DL, C53, C53D, C6, C60, C60D, C81, CR43, CR43D, CR48, CR48D, DP35, DP35-2, DP35D, DP40, DP40-2, DP40D, DP40-rib2, DP45, DP45D, DP50, DP50D, FW35, FW40, FW40B, FW45, FW50, RSP40, RSP50...(Other models you can see in the webshop)		

			
1			
GEV No.	345651	Ref. No.	33596
description	switch 2CO 250V 16A connection male faston 6.3mm		
For models:	C43-2, C43D, C48-2, C48D, C48D-2, C48DDL, C53D, C60D, C6D, CDN3, CDN4, CR43D, CR48D, DP35D, DP35D-2, DP40D, DP40D-2, DP40D-rib2, DP45D, DP50D, SP35-2, SP35D, SP40-2, SP40D, SP40D-2, SP40DDL, SP45D, SP50D, SP5D, SPR36D, SPR41D, STS43D, STS43D-2, STS48D, STS48D-2, STS48D-rib2, STS53D, STS60D, TDN4-2rib, TN-TDN5, TN-TDN6		

			
1			
GEV No.	347098	Ref. No.	32873
description	switch 2CO 250V 16A connection male faston 6.3mm		
For models:	C35E, C48E, RSP40A, RSP50A, SP40E, SPB35E		

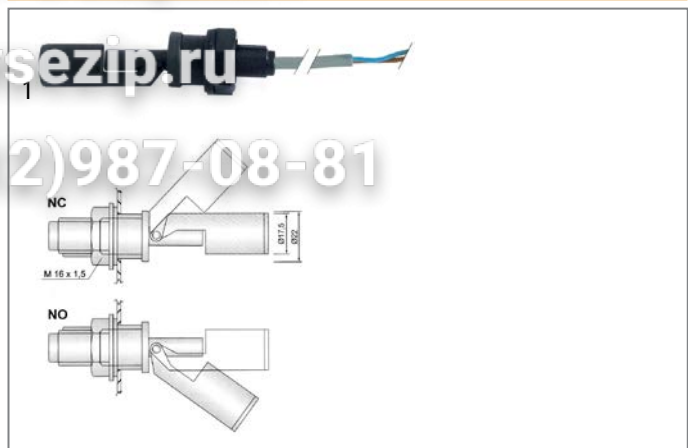

GEV No.	345822	Ref. No.	120358 H120358
description	float switch thread M16x1.5 1NO or 1NC ø 17.4mm L 98mm mounting ø 16mm 250V 0.5A cable cable length 2000mm		
For models:	60BT, SD5BT		

rotary switches

BREMAS

A1200 series

			
1			
GEV No.	345019	Ref. No.	H120712
description	rotary switch sets of contacts 2 2 0-1 type CA0120002 380V 12A shaft ø 5x5mm shaft L 23mm shaft square connection screw		
For models:	EDT85, TR100, TR90, TR-E90		

A1600 series

			
1			
GEV No.	300222	Ref. No.	H120715
description	rotary switch 3 0-1-2 sets of contacts 4 type CS0167133 400V 16A shaft ø 5x5mm shaft L 24mm shaft square connection screw		
For models:	EDT140, EDT170, EDT200, EDT230, TR140, TR170, TR200		

			
1			
GEV No.	345838	Ref. No.	120744 H120744
description	rotary switch 3 0-1-2 sets of contacts 4 type CS0168505 400V 16A shaft ø 5x5mm shaft L 23mm shaft square connection screw		
For models:	RCA1100		

electric components



Зип Общежит

magnetic switches

vsezip.ru

7(812)987-08-81



1

GEV No.	300330	Ref. No.	110805 H110805 old version
description	rotary switch 3 1-0-2 sets of contacts 2 type CS0168351 400V 16A shaft \varnothing 5x5mm shaft L 25mm shaft square connection screw		

A1700 series



1

GEV No.	300262	Ref. No.	H110805
description	rotary switch 3 1-0-2 sets of contacts 2 400V 16A shaft \varnothing 5x5mm shaft L 25mm shaft square connection screw		
For models:	EDT140, EDT170, EDT200, EDT230, TR140, TR170, TR200		



1

GEV No.	345007	Ref. No.	H120713
description	rotary switch 4 0-1-2-3 sets of contacts 6 type CS0178766 400V 20A shaft \varnothing 5x5mm shaft L 25mm shaft square connection screw		
For models:	C98, EDI5, LO61, LO62, RCA1200, RCA1200i		

A2500 series



1

GEV No.	347687	Ref. No.	H120733
description	rotary switch 3 0-1-2 sets of contacts 4 type CS0257997 600V 32A shaft \varnothing 5x5mm shaft L 24mm shaft square connection screw		

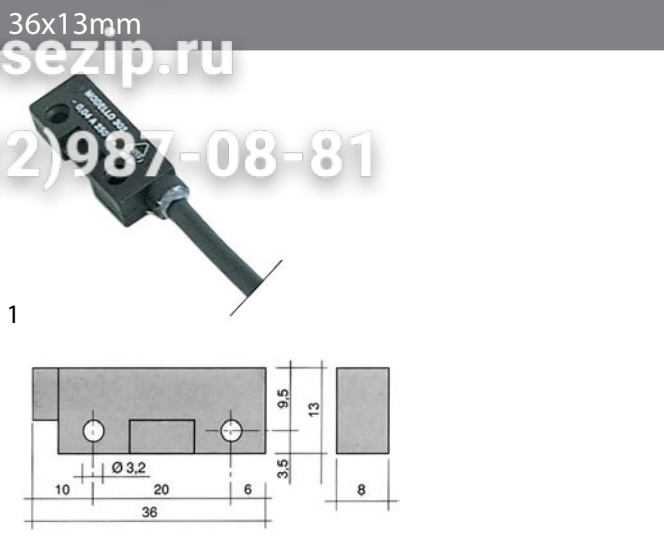

1

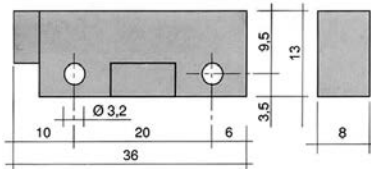

GEV No.	345335	Ref. No.	33188
description	magnetic switch L 36mm W 13mm 1NO 250V 0.04A P max. 10W connection cable length 960mm		
For models:	60BT, 60BT-3, 60EBT, AP43E, AP48E, AP53E, AP60E, APS43, APS48, APS48B, AP53, APS60, APSE43, APSE48, APSE53, APSE60, C35, C35E, C43, C43-2, C43ALTA, C43D, C43DE, C43E, C46DE, C46E, C48, C48-2, C48D, C48D-2, C48DDL, C48DL, C48E, C53, C53D, C53DE, C53E, C6, C60, C60D, C60DE, C60E, C68DE, C68E, C68EBT, C6D, C6DE, C6E, C81, C81E...(Other models you can see in the webshop)		
accessories for	345335		
		GEV No.	519049
		Ref. No.	32969
	magnet \varnothing mm L 63mm H 10.7mm W 18.8mm hole distance 52mm M2 hole \varnothing 2mm		

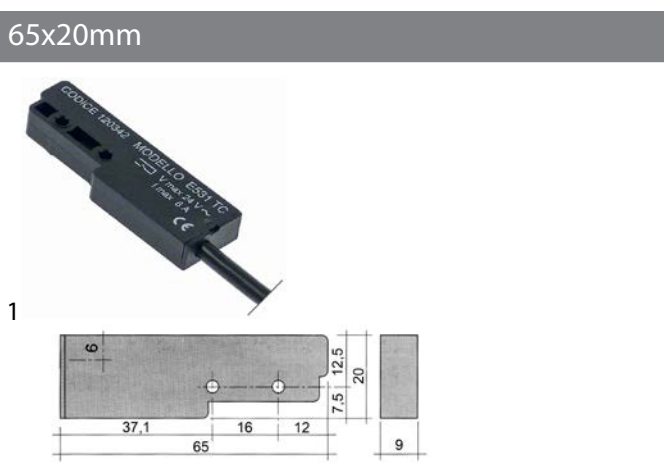

1

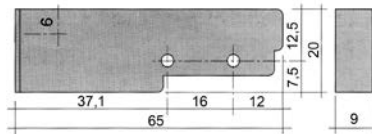

GEV No.	345122 ¹	Ref. No.	120342 32968 H120342
description	magnetic switch L 65mm W 20mm 1NO 24V 8A P max. 192W connection male faston 6.3mm cable length 344mm		
For models:	AC101, AC151, AC181, AC201, AC241, AC91, CAP10, CAP10BT, CAP10DE, CAP12, CAP12DE, CAP12EBT, CAP7E, ED600-95, ED700-90, ED900-90, EDI13, EDI13ALTA, EDI5, EDI6, EDI8, EDT100, EDT140, EDT170, EDT200, EDT230, EDT85, HT100, HT150, HTP195, HTP205, HTP220, LO122, LO134, LO134ALTA, LO60, LO61, LO67, LO78, LO83, RLO200, RLO300, RLO400, SO100, SO100-400V3-50Hz-MARINE, SO100-440V3-60Hz-MARINE, SO120, TR100, TR140, TR170...(Other models you can see in the webshop)		

¹with coded connector



Зип Общепит
control equipment

vsezip.ru
push buttons

+7(812)987-08-81



1

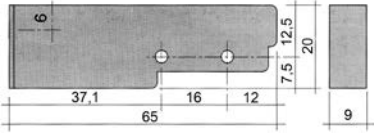

GEV No.	345116	Ref. No.	32968
description	magnetic switch L 65mm W 20mm 1NO 250V 0.4A P max. 100W connection cable cable length 3000mm		
accessories for	345116		
	GEV No.	345399	Ref. No.
			—
	magnet ø 3.3mm L 40mm H 8mm W 13mm hole distance 30mm M3		

miscellaneous



1

GEV No.	347477	Ref. No.	H120317
description	magnetic switch cable length 520mm		
For models:	EDT100, EDT140, EDT170, EDT200, EDT230, EDT85, TR100, TR140, TR170, TR200, TR230, TR90, TR-E100, TR-E150, TR-E170, TR-E200, TR-E230, TR-E90		

accessories

magnets

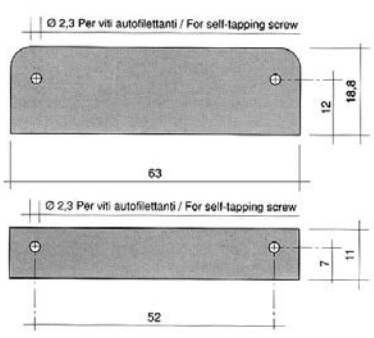
1

GEV No.	519049	Ref. No.	32969
description	magnet ømm L 63mm H 10.7mm W 18.8mm hole distance 52mm M2 hole ø 2mm		
For models:	60BT, 60BT-3, 60EBT, APS43, APS48, APS48B, APS53, APS60, APSE43, APSE48, APSE53, APSE60, C35, C35E, C43, C43-2, C43ALTA, C43D, C43DE, C43E, C46DE, C46E, C48, C48-2, C48D, C48D-2, C48DDL, C48DL, C48E, C53, C53D, C53DE, C53E, C6, C60, C60D, C60DE, C60E, C68DE, C68E, C68EBT, C6D, C6DE, C6E, C81, C81E, C81EBT, C90, C90DE, C90DE2...(Other models you can see in the webshop)		
accessories for	519049		
	GEV No.	560095	Ref. No.
			25684
	sheet metal screws ø 2.9mm L 9.5mm SS Qty 20 pcs DIN 7981/ISO 7049 head ø 5.6mm oval head		

SCHLEGEL



1

GEV No.	345932	Ref. No.	25460
description	momentary switch unit mounting measurements ø16/24x24mm type momentary black/blue square		



1

GEV No.	345930	Ref. No.	25454
description	momentary switch unit mounting measurements ø16/24x24mm type momentary black/red square		
For models:	T6-80		

switch blocks



1

GEV No.	359194	Ref. No.	25456
description	contact block latching 1NC/1NO connection male faston 2.8mm illuminable socket T5.5K type AFL		
For models:	T6-80		



1

GEV No.	359186	Ref. No.	25457
description	contact block momentary 1NC/1NO connection male faston 2.8mm illuminable socket T5.5K type ATL		
For models:	T6-80		

ABB



1

GEV No.	348089	Ref. No.	H130410
description	contact block ABB MCB-01 1NC max 400V 8A black/red		
For models:	EDT100, EDT140, EDT170, EDT200, EDT230, EDT85		

electric components



Зип Общепит

vsezip.ru

+7(812)987-08-81



1

GEV No.	347987	Ref. No.	H130411
description	contact block ABB MCB-10 1NO max 400V 8A black/green		
For models:	EDT100, EDT140, EDT170, EDT200, EDT230, EDT85		
accessories for	347987		



GEV No.	347986	Ref. No.	H130413
description	push button mounting measurements ø22mm green		

ø22mm

push buttons



1

GEV No.	347986	Ref. No.	H130413
description	push button mounting measurements ø22mm green		
For models:	EDT100, EDT140, EDT170, EDT200, EDT230, EDT85		
accessories for	347986		



GEV No.	347987	Ref. No.	H130411
description	contact block ABB MCB-10 1NO max 400V 8A black/green		

switches (complete)



1

GEV No.	347573	Ref. No.	130453 H130453
description	emergency stop switch complete yellow/red		
For models:	AC101, AC151, AC181, AC201, AC241, AC91, EDT100, EDT140, EDT170, EDT200, EDT230, EDT85, TR100, TR140, TR170, TR200, TR230, TR90, TR-E100, TR-E150, TR-E170, TR-E200, TR-E230		

TELEMECANIQUE (EFA)

XA2 series



1

GEV No.	345220	Ref. No.	30079
description	contact block EFA ZB2BE101 1NO max 230V 10(6)A black		
For models:	DP50D-115V, ED650S-90		



1

GEV No.	345221	Ref. No.	29248
description	contact block EFA ZB2BE102 1NC max 230V 10(6)A black		
For models:	DP50D-115V, ED630-90, ED650S-90		

XB2 series



1

GEV No.	345935	Ref. No.	31963
description	contact block 1NO		
For models:	C90, CA120, CA90, DP50D-115V, ED600-95, ED650E, ED650S, ED700-90, ED900-90, LO122, LO50, LO60, LO78, RLO50, SMW15, US-X501		



1

GEV No.	345220	Ref. No.	30079
description	contact block EFA ZB2BE101 1NO max 230V 10(6)A black		
For models:	DP50D-115V, ED650S-90		



1

GEV No.	345221	Ref. No.	29248
description	contact block EFA ZB2BE102 1NC max 230V 10(6)A black		
For models:	DP50D-115V, ED630-90, ED650S-90		



1

GEV No.	345937	Ref. No.	34035
description	contact block with holder 1NO		
For models:	C90, CA120, CA90, ED650E, ED650S, EDI13, EDI13ALTA, EDI6, EDI8, LO134, LO134ALTA, LO50, LO67, LO83, RLO200, RLO300, RLO400, RLO50, SMW15, US-X501		



Зип-Общепит

vsezip.ru

+7(812)987-08-81



1

GEV No.	345938	Ref. No.	34036
description	contact block with holder 1NO/1NC		
For models:	C90, CA120, CA90, DP50D-115V, ED650E, ED650S, LO50, RLO50, SMW15, US-X501		

push buttons



1

GEV No.	347934	Ref. No.	36871
description	push button mounting measurements ø22mm black		

switches (complete)



1

GEV No.	345933	Ref. No.	26931
description	rotary selector mounting measurements ø22mm		
For models:	ED630-90, ED650S, ED650S-90		

miscellaneous



1

GEV No.	345936	Ref. No.	31962
description	contact block 1NC		
For models:	C90, CA120, CA90, DP50D-115V, ED650E, ED650S, LO50, RLO50, SMW15, US-X501		

rotary switches



1

GEV No.	345222	Ref. No.	32069
description	rotary selector mounting measurements ø22mm black latching sequence 0-1		
For models:	C90, CA120, CA90, ED650E, ED650S, EDI13, EDI13ALTA, EDI6, EDI8, LO134, LO134ALTA, LO50, LO67, LO83, RLO200, RLO300, RLO400, RLO50, SMW15, US-X501		



1

GEV No.	347932	Ref. No.	32070
description	indicator socket L 39mm 1-pole		
For models:	ED600-95, ED700-90, ED900-90, LO122, LO60, LO78		



1

GEV No.	345223	Ref. No.	31053 31420
description	rotary selector mounting measurements ø22mm black latching sequence 1-0-2		
For models:	C90, CA120, CA90, DP50D-115V, ED630-90, ED650E, ED650S, ED650S-90, LO50, RLO50, SMW15, US-X501		



1

GEV No.	347493	Ref. No.	32071
description	signal element blue L 28mm socket bayonet 2mm with gasket ø 30mm		
For models:	ED600-95, ED700-90, ED900-90, LO122, LO60, LO78		



1

GEV No.	347410	Ref. No.	32065
description	rotary selector mounting measurements ø22mm green latching sequence 0-1		
For models:	ED600-95, ED700-90, ED900-90, LO122, LO60, LO78		

encoders and potentiometers



1

GEV No.	403273	Ref. No.	34908
description	encoder rotation 135° shaft ø 6mm shaft L 5mm cycle ø 26mm		
For models:	EDI13, EDI13ALTA, EDI6, EDI8, LO134, LO134ALTA, LO67, LO83, RLO200, RLO300, RLO400		

electric components



lamps

indicator lights

indicator lights 2-piece (lens and indicator lamp)

indicator light lenses

ø10mm (type SRZ-2)



GEV No.	359359	Ref. No.	34605
description	indicator light housings mounting measurements ø10mm green square		
For models:	60BT, 60BT-3, C98, CA55, CAP7, ED550, EDI5, GS-X1011, GS-X1011-2, GS-X1011-WEH, GS-X1011-WEH-2, GS-X1021, GS-X1021-2, GS-X1021-2rib, GS-X1021-WEH, GS-X1021-WEH-2, GS-X1021-WEH-2rib, LO61, LO62, SD5BT, SO55, SO55-400V3-50Hz-MARINE, SO55-440V3-60Hz-MARINE, VS-X313, VS-X313-LP-DOS, VS-X515, VS-X515-LP-DOS		



GEV No.	359808	Ref. No.	34627
description	indicator light housings mounting measurements ø10mm green temperature		
For models:	C98, CA55, CAP7, ED550, EDI5, GS-X1011, GS-X1011-2, GS-X1011-WEH, GS-X1011-WEH-2, GS-X1021, GS-X1021-2, GS-X1021-2rib, GS-X1021-WEH, GS-X1021-WEH-2, GS-X1021-WEH-2rib, LO61, LO62, SO55, SO55-400V3-50Hz-MARINE, SO55-440V3-60Hz-MARINE, VS-X313, VS-X313-LP-DOS, VS-X515, VS-X515-LP-DOS		



GEV No.	359358	Ref. No.	34604
description	indicator light housings mounting measurements ø10mm orange square		
For models:	60BT, 60BT-3, C98, CA55, CAP7, ED550, EDI5, GS-X1011, GS-X1011-2, GS-X1011-WEH, GS-X1011-WEH-2, GS-X1021, GS-X1021-2, GS-X1021-2rib, GS-X1021-WEH, GS-X1021-WEH-2, GS-X1021-WEH-2rib, LO61, LO62, SD5BT, SO55, SO55-400V3-50Hz-MARINE, SO55-440V3-60Hz-MARINE, VS-X313, VS-X313-LP-DOS, VS-X515, VS-X515-LP-DOS		

indicator lamps for socket type SRZ / SDK / SDY / SFK



GEV No.	359130	Ref. No.	28870
description	indicator lamp 230V clear connection male faston 6.3mm ø 8mm		
For models:	APS43, APS48, APS53, APS60, C3, C35, C4, C43, C43-2, C43ALTA, C43D, C48, C48-2, C48D, C48D-2, C48DDL, C48DL, C53, C53D, C6, C60, C60D, C6D, C98, CA55, CAP7, CDN3, CDN4, CM43, CM48, CM52, CM60, CMD43, CMD48, CMD52, CR43, CR43D, CR48, CR48D, DP35, DP35-2, DP35D, DP35D-2, DP40, DP40-2, DP40D, DP40D-2, DP40D-rib2, DP40-rib2, DP45...(Other models you can see in the webshop)		



GEV No.	359129	Ref. No.	33187
description	indicator lamp 24V clear connection male faston 6.3mm		
For models:	APS43, APS48, APS48B, APS53, APS60, APSE43, APSE48, APSE53, APSE60, C48E, C81, C90, CA120, CA90, CAP7, ED650E, ED650S, FW35, FW40, FW40B, FW45, FW50, LO50, RLO50, SMW15, SO55, SP40E, SP81, US-X501		

Зип Общепит

vsezip.ru

+7(812)987-08-81

GEV No.	359132	Ref. No.	32892
description	indicator lamp green 250V connection male faston 6.3mm protection 154 ar b a temperature max. 85°C		
For models:	60BT, 60BT-3, C35, C43, C43-2, C43ALTA, C43D, C48, C48-2, C48D, C48D-2, C48DDL, C48DL, C48E, C53, C53D, C6, C60, C60D, C6D, C98, CA55, CAP7, CR43, CR43D, CR48, CR48D, DP35, DP35-2, DP35D, DP40, DP40-2, DP40D, DP40-rib2, DP45, DP45D, DP50, DP50D, ED550, EDI5, GS-X1011, GS-X1011-2, GS-X1011-WEH, GS-X1011-WEH-2, GS-X1021, GS-X1021-2, GS-X1021-2rib, GS-X1021-WEH, GS-X1021-WEH-2, GS-X1021-WEH-2rib...(Other models you can see in the webshop)		

GEV No.	359350	Ref. No.	34236
description	indicator light 230V blue connection male faston 6.3mm ø 11mm		
For models:	C35, C43, C43-2, C43ALTA, C43D, C48, C48-2, C48D, C48D-2, C48DDL, C48DL, C53, C53D, C6, C60, C60D, C6D, CDN3, CDN4, CR43, CR43D, CR48, CR48D, DP35, DP35-2, DP35D, DP35D-2, DP40, DP40-2, DP40D, DP40D-2, DP40D-rib2, DP40-rib2, DP45, DP45D, DP50, DP50D, SP35, SP35-2, SP35ALTA, SP35D, SP40, SP40-2, SP40D, SP40D-2, SP40DDL, SP40DL, SP45, SP45D, SP5...(Other models you can see in the webshop)		
accessories for	359350		
	GEV No.	345601	Ref. No. 32891
	indicator lamp holder V ø 11mm		

indicator lights 3-piece (housing, lens and bulb)

lamps

neon light bulbs

GEV No.	359000	Ref. No.	130138 26929 H130138
description	neon light bulb socket Ba9s 24V 3W clear ø 10mm L 24mm		
For models:	AC151, AC181, AC201, AC241, EDT140, EDT170, EDT200, EDT230		
accessories for	359000		
	GEV No.	359060	Ref. No. —
	lamp socket mounting measurements ø16.2mm socket E10 connection screw		
	GEV No.	359063	Ref. No. —
	lamp socket mounting measurements ø19.2mm socket E14 connection screw		
	GEV No.	359064	Ref. No. —
	lamp socket mounting measurements ø22.3mm socket E14 connection screw 250/380V ambient temperature at 1W 100°C ambient temperature at 2W 85°C		
	GEV No.	359685	Ref. No. —
	lamp socket mounting measurements ø16.2mm socket E10		
	GEV No.	359832	Ref. No. —
	lamp socket mounting measurements ø16.2mm socket Ba9s connection male faston 6.3mm		



Table continues overleaf



Зип Общепит

vsezip.ru

+7(812)987-08-81

accessories for	359000		
	GEV No.	359853	Ref. No. —
	lamp socket mounting measurements ø18.2mm socket Ba9s connection male faston 6.3mm		
	GEV No.	359988	Ref. No. —
	lamp socket mounting measurements ø30.5mm 250V connection F6.3 temp.-resist. 55°C E14		

GEV No.	345927	Ref. No.	28789
description	indicator light housings mounting measurements 28.5x28.5mm red level		
For models:	CM43, CM48, E36, E40, E40-2F, E43, K80F, K80G, NK43, NK48, T3-80, T4-80, T5-80		

indicator lights (complete)			
ø13mm			
with plug-in socket			
			
1	GEV No.	359142	Ref. No. 30844
description	indicator light ø 13mm green 230V connection male faston 6.3mm temp.-resist. 120°C Qty 1 pcs		
For models:	BPN48, BPS43, BPS52, ED630-90, UNI43C, UNI43R, UNI43RD, UNI48C, UNI48CD, UNI48R, UNI48RD, UNI53C, UNI53R, UNI53RD, UNI60C		

1			
GEV No.	359800	Ref. No.	29665
description	indicator light housings mounting measurements 28.5x28.5mm green		
For models:	INDY43F, INDY48F, INDY53F, INDY60F		

1			
GEV No.	359141	Ref. No.	25478
description	indicator light ø 13mm red 230V connection male faston 6.3mm temp.-resist. 120°C Qty 1 pcs		
For models:	BPN48, BPS43, BPS52, E36, E40, E43, E50, ED600-95, ED630-90, ED650E, ED650E-90, ED650S, ED650S-90, ED700-90, ED900-90, LO122, LO60, LO78, M60, T6-80, UNI43C, UNI43R, UNI43RD, UNI48C, UNI48CD, UNI48R, UNI48RD, UNI53C, UNI53R, UNI53RD, UNI60C		

1			
GEV No.	359799	Ref. No.	29012
description	indicator light housings mounting measurements 28.5x28.5mm red		
For models:	CM48, CM52, INDY43F, INDY48F, INDY53F, INDY60F, TS43, TS48		

1			
GEV No.	359143	Ref. No.	25479 25480
description	indicator light ø 13mm yellow 230V connection male faston 6.3mm temp.-resist. 120°C Qty 1 pcs		
For models:	BPN48, BPS43, BPS52, E36, E40, E43, E50, ED630-90, ED650E, ED650E-90, ED650S, ED650S-90, M60, T6-80, UNI43C, UNI43R, UNI43RD, UNI48C, UNI48CD, UNI48R, UNI48RD, UNI53C, UNI53R, UNI53RD, UNI60C		

1			
GEV No.	359798	Ref. No.	29011
description	indicator light housings mounting measurements 28.5x28.5mm yellow		
For models:	CM48, CM52, CMD43, CMD52, INDY43F, INDY48F, INDY53F, INDY60F, TS43, TS48		

screw-on/push-on fit

neon light bulbs

28.5x28.5mm			
1			
GEV No.	345926	Ref. No.	28788
description	indicator light housings mounting measurements 28.5x28.5mm orange connection cycle		
For models:	CM43, CM48, CM52, CMD43, CMD48, CMD52, CMD60, E36, E40, E40-2F, E43, E50, K80F, K80G, NK43, NK48, NK52, NK60, NKD43, NKD48, NKD52, NKD60, T3-80, T4-80, T5-80		









1			
GEV No.	359000	Ref. No.	130138 26929 H130138
description	neon light bulb socket Ba9s 24V 3W clear ø 10mm L 24mm		
For models:	AC151, AC181, AC201, AC241, EDT140, EDT170, EDT200, EDT230		
accessories for	359000		
	GEV No.	359060	Ref. No. —
	lamp socket mounting measurements ø16.2mm socket E10 connection screw		
	GEV No.	359063	Ref. No. —
	lamp socket mounting measurements ø19.2mm socket E14 connection screw		



Table continues overleaf





accessories for		359000	
	GEV No.	359064	Ref. No. —
lamp socket mounting measurements ø22.3mm socket E14 connection screw 250/380V ambient temperature at 1W 100°C ambient temperature at 2W 85°C			
	GEV No.	359685	Ref. No. —
lamp socket mounting measurements ø16.2mm socket E10			
	GEV No.	359832	Ref. No. —
lamp socket mounting measurements ø16.2mm socket Ba9s connection male faston 6.3mm			
	GEV No.	359853	Ref. No. —
lamp socket mounting measurements ø18.2mm socket Ba9s connection male faston 6.3mm			
	GEV No.	359988	Ref. No. —
lamp socket mounting measurements ø30.5mm 250V connection F6.3 temp.-resist. 55°C E14			

timers

programme timers



			
1			
GEV No.	360038	Ref. No.	25389
description	timer CDC 4803F engines 1 chambers 3 operation time 120s 230V manuf. no. 4803F1 / 360038 motor type M48R ATS		
spare parts for	360038		
	GEV No.	360118	Ref. No. —
motor CDC pinion ø 4.9mm teeth 10 230V voltage AC 50/60Hz turn direction right motor ø 47mm H 19.3mm motor type M48R ATS for timer cable length 260mm 1.9/2.5W			



			
1			
GEV No.	360037	Ref. No.	25392
description	timer CDC 4803F engines 1 chambers 3 operation time 180s 230V manuf. no. 4803F3 / 360037 motor type M48R ATS		
For models:	M60, T6-80		
spare parts for	360037		
	GEV No.	360118	Ref. No. —
motor CDC pinion ø 4.9mm teeth 10 230V voltage AC 50/60Hz turn direction right motor ø 47mm H 19.3mm motor type M48R ATS for timer cable length 260mm 1.9/2.5W			

Зип Общежит

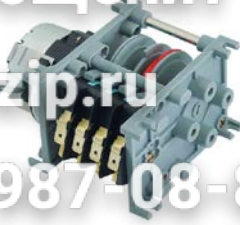
vsezip.ru

+7(812)987-08-81

			
1			
GEV No.	360310	Ref. No.	29828
description	timer CDC 4804M engines 1 chambers 4 operation time 120s 230V shaft ømm shaft Lmm manuf. no. 4804M1 / 29828 motor type M48R ATS		
For models:	ED650E, ED650E-90		
spare parts for	360310		
	GEV No.	360118	Ref. No. —
motor CDC pinion ø 4.9mm teeth 10 230V voltage AC 50/60Hz turn direction right motor ø 47mm H 19.3mm motor type M48R ATS for timer cable length 260mm 1.9/2.5W			

			
1			
GEV No.	360035	Ref. No.	25381 31882
description	timer CDC 4902F engines 1 chambers 2 operation time 120s 230V shaft ø 6x4.6mm shaft L 17mm manuf. no. 4902F1 / 3322050 motor type M48L ATS		
For models:	E36, E40, E43, E50		
spare parts for	360035		
	GEV No.	360083	Ref. No. —
motor CDC pinion ø 4.9mm teeth 10 230V turn direction left motor ø 47mm H 19.3mm motor type M48L ATS for timer			

			
1			
GEV No.	360493	Ref. No.	25404
description	timer CDC 6005F engines 1 chambers 5 operation time 90s 230V 50/60Hz motor type M48R ATS		
For models:	ED600-95, ED700, ED700-90, ED900, ED900-90, LO122, LO60, LO78		

Зип Общежит

vsezip.ru

+7(812)987-08-81



1

GEV No.	360311	Ref. No.	32529
description	timer CDC 7003F engines 1 chambers 3 operation time 6min 230V shaft ø 6x4.6mm shaft L 22mm manuf. no. 7003F3/32529 motor type M37LN		
For models:	UNI43C, UNI43R, UNI43RD, UNI48C, UNI48CD, UNI48R, UNI48RD, UNI53C, UNI53R, UNI53RD, UNI60C		
spare parts for	360311		
	GEV No.	360131	Ref. No. —
	motor CDC pinion ø 5.4mm teeth 12 230V turn direction left motor ø 37mm motor type M37LN for timer		



1

GEV No.	360308	Ref. No.	26880
description	timer CDC 7803 engines 1 chambers 3 operation time 18min 230V shaft ømm shaft Lmm manuf. no. 7803F1 / 26880 motor type M37RN		
For models:	C43-2, C43D, C48-2, C48D, C48D-2, C48DDL, C53D, C60D, C6D, CDN3, CDN4, CMD43, CMD48, CMD52, CR43D, CR48D, DP35D, DP35D-2, DP40D, DP40D-2, DP40D-rib2, DP45D, DP50D, NKD43, RSP40A, RSP50A, SP35-2, SP35D, SP40-2, SP40D, SP40D-2, SP40DDL, SP45D, SP50D, SP5D, SPR36D, SPR41D, STS43D, STS43D-2, STS48D, STS48D-2, STS48D-rib2, STS53D, STS60D, TDN4-2rib, TN-TDN5, TN-TDN6, UNI43RD, UNI48CD, UNI48RD...(Other models you can see in the webshop)		
spare parts for	360308		
	GEV No.	360119	Ref. No. —
	motor CDC pinion ø 5.4mm teeth 12 230V turn direction right motor ø 37mm motor type M37RN for timer		



1

GEV No.	360092	Ref. No.	30347
description	timer CDC 7803 engines 1 chambers 3 operation time 120s 230V shaft ømm shaft Lmm manuf. no. 7803F1 / 360092 motor type M37RN		
For models:	C3, C4, C43, C43ALTA, C43D, C48, C48D, C48DDL, C48DL, C53, C53D, C60, C60D, CR43, CR43D, CR48, CR48D, DP35, DP35D, DP40, DP40D, DP45, DP45D, DP50, DP50D, E40-2F, INDY43F, INDY48F, INDY53F, INDY60F, SP35, SP35ALTA, SP35D, SP40, SP40D, SP40DDL, SP40DL, SP45, SP45D, SP50, SP50-400V, SP50-440V, SP50D, SPR36, SPR36D, SPR41, SPR41D, STS43, STS43D, STS48...(Other models you can see in the webshop)		
spare parts for	360092		
	GEV No.	360119	Ref. No. —
	motor CDC pinion ø 5.4mm teeth 12 230V turn direction right motor ø 37mm motor type M37RN for timer		



1

GEV No.	360574	Ref. No.	31577
description	timer CDC 7804 engines 1 chambers 4 operation time 180s 230V 50Hz shaft ømm shaft Lmm motor type M37RN voltage AC		



1

GEV No.	360684	Ref. No.	34402
description	timer CDC 7804F1 / 34402 engines 1 chambers 4 operation time 120s 230V shaft ømm shaft Lmm manuf. no. 7804F10ADE000.0030		
For models:	C35, C43, C43-2, C43ALTA, C43D, C48, C48-2, C48D, C48D-2, C48DDL, C48DL, C53, C53D, C60, C60D, CDN3, CDN4, CR43, CR43D, CR48, CR48D, DP35, DP35-2, DP35D, DP35D-2, DP40, DP40-2, DP40D, DP40D-2, DP40D-rib2, DP40-rib2, DP45, DP45D, DP50, DP50D, RSP40, RSP50, RSP50A, SP35, SP35-2, SP35ALTA, SP35D, SP40, SP40-2, SP40D, SP40D-2, SP40DDL, SP40DL, SP45...(Other models you can see in the webshop)		

Зип Общепит

vsezip.ru

+7(812)987-08-81



1

GEV No.	360040	Ref. No.	25386
description	timer CDC 9003F engines 1 chambers 3 operation time 6min 230V shaft ø 6x4.6mm shaft L 21mm manuf. no. 9003F3 / PRCIH5 motor type M48R ATS		
For models:	NK43, NK48, NK52, NK60, NKD43, NKD48, NKD52, NKD60, T3-80, T4-80		
spare parts for	360040		
	GEV No.	360118	Ref. No.
			—
	motor CDC pinion ø 4.9mm teeth 10 230V voltage AC 50/60Hz turn direction right motor ø 47mm H 19.3mm motor type M48R ATS for timer cable length 260mm 1.9/2.5W		
accessories for	360040		
	GEV No.	110197	Ref. No.
			25095
	knob switch zero mark ø 42mm shaft ø 6x4.6mm shaft flat adjustable black		



1

GEV No.	360448	Ref. No.	31882
description	timer FIBER P26 engines 1 chambers 3 operation time 120s 230V manuf. no. P265J03H313 motor type M61B40L0000		



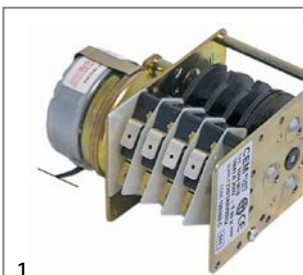

1

GEV No.	360086	Ref. No.	34402 old version
description	timer FIBER P26 engines 1 chambers 4 operation time 120s 230V shaft ømm shaft Lmm manuf. no. P265J04H315 motor type M61B40R6400		



1

GEV No.	360043	Ref. No.	H120262
description	timer CEM HH4M16 engines 1 chambers 4 operation time 120s 230V shaft ømm shaft Lmm manuf. no. HH4M16 / 120262 motor type UDS11NE1RH		
spare parts for	360043		
	GEV No.	360112	Ref. No.
			—
	motor SAIA pinion ø 4mm teeth 12 230V turn direction right motor ø 48mm motor type UDS11NE1RHZ for timer		





1

GEV No.	360306	Ref. No.	32361
description	timer FIBER P26 engines 1 chambers 6 operation time 150s 230V shaft ømm shaft Lmm manuf. no. P265J06H427 motor type M61B40R6400		
For models:	APS43, APS48, APS53, APS60, FW35, FW40, FW45, FW50		



1

GEV No.	360093	Ref. No.	31054
description	timer FIBER P25 engines 2 chambers 5 operation time 40s / 3min 230V manuf. no. P255J05JKL0 motor type M51BJ0R6400 / M51B-J0L6400		
For models:	CM48, CM52, CMD43, CMD52, ED630-90, ED650S-90, TS43, TS48		
spare parts for	360093		
	GEV No.	360673	Ref. No.
			—
	motor kit pinion ø 6.8mm teeth 15 230V voltage AC 50/60Hz turn direction clockwise motor ø 48mm H 18.5mm motor type UDS-40NE1RNZ165 cable length 150mm with holder		
	GEV No.	360674	Ref. No.
			—
	motor kit pinion ø 6.8mm teeth 15 230V voltage AC 50/60Hz turn direction counterclockwise motor ø 48mm H 18.5mm motor type UDS40NE1RNZ165 cable length 150mm with holder		



1

GEV No.	360307	Ref. No.	32362
description	timer FIBER P26 engines 1 chambers 6 operation time 180s 230V shaft ømm shaft Lmm manuf. no. P265J06H528 motor type M61B40R6400		
For models:	APS43, APS48, APS53, APS60, FW35, FW40, FW45, FW50		



Зип Общежит

contactors

vsezip.ru
power contactors

+7(812)987-08-81



1

GEV No.	360626	Ref. No.	31577
description	timer FIBER P265J04H571 engines 1 chambers 4 operation time 180s 230V 50Hz shaft ømm shaft Lmm voltage AC		
For models:	C6, C6D, SP5, SP5D		



1

GEV No.	360036	Ref. No.	25384	
description	timer FIBER P39 engines 1 chambers 3 operation time 120s 230V shaft ø 6x4.6mm shaft L 16mm manif. no. P395J03H301 motor type M51BJ0L6400			
For models:	CM43, CM48, CM52, CMD43, CMD48, CMD52, CMD60, K80F, K80G			
spare parts for	360036			
	GEV No.	360674	Ref. No.	—
	motor kit pinion ø 6.8mm teeth 15 230V voltage AC 50/60Hz turn direction counterclockwise motor ø 48mm H 18.5mm motor type UDS40NE1RNZ165 cable length 150mm with holder			

digital timers



1

GEV No.	400945	Ref. No.	120226
description	timer electronic		



1

GEV No.	380239	Ref. No.	25505 29807 31873 31982
description	power contactor resistive load 20A 230VAC (AC3/400V) 8.4A/4kW main contacts 3NO auxiliary contacts 1NC connection screw connection type LS05 01A type AEG LS05 01A type GE MC1A 301A		
For models:	60BT, 60BT-3, 60EBT, AP43E, AP48E, AP53E, AP60E, APS43, APS48, APS48B, APS53, APS60, APSE43, APSE48, APSE53, APSE60, BPN48, BPS43, BPS52, C43, C43ALTA, C48, C48D, C48DDL, C48DL, C53, C53D, C53DE, C53E, C60, C60D, C60DE, C60E, C68DE, C68E, C68EBT, C6EBT, C81, C81E, C81EBT, C90, C90DE, C90DE2, C90E, C90E2, C90EBT, C90EBT2, C98, CA120, CA55...(Other models you can see in the webshop)		



1

GEV No.	380238	Ref. No.	25506
description	power contactor resistive load 20A 230VAC (AC3/400V) 8.4A/4kW main contacts 3NO auxiliary contacts 1NO connection screw connection type LS0510A type AEG LS0510A type GE MC1A 310A		
For models:	ED650E, ED650E-90, T6-80		



1

GEV No.	380262	Ref. No.	31981
description	power contactor resistive load 32A 230VAC (AC3/400V) 17A/7.5kW main contacts 3NO auxiliary contacts 1NC connection screw connection type AEG LS7K01A type GE CL02A 301 H 85mm		
For models:	CA120, CA90, CAP10BT, ED600-95, ED650E, ED650S, ED700-90, ED900-90, EDI13, EDI13-2, EDI13ALTA, EDI13ALTA-2, EDI13ALTABT, EDI13BT, EDI4, EDI6, EDI6-2, EDI6BT, EDI8, EDI8-2, EDI8BT, LO122, LO134, LO134-2, LO134ALTA, LO134ALTA-2, LO56, LO60, LO67, LO67-2, LO78, LO83, LO83-2, RLO200, RLO300, RLO400		

electric components

Зип Общепит

vsezip.ru

+7(812)987-08-81



GEV No.	380261	Ref. No.	25501
description	power contactor resistive load 32A 230VAC (AC3/400V) 17A/7.5kW main contacts 3NO auxiliary contacts 1NO connection screw connection type AEG LS7K 10A type GE CL02A 310		
For models:	ED630-90, ED650E, ED650E-90, ED650S-90		



GEV No.	380626	Ref. No.	29839
description	power relays FINDER 230VAC 10A 2CO connection male faston 4.8mm bracket mounting manuf. no. 62.62.8.230.0000		
For models:	APS43, APS48, APS53, APS60, FW35, FW40, FW45, FW50		

ISKRA (FANAL)

power contactors



GEV No.	380212	Ref. No.	H120461
description	power contactor resistive load 20A 230VAC (AC3/400V) 8.5A/5.5kW main contacts 3NO auxiliary contacts 1NC connection screw connection type Fanal K07M 01 type ISKRA DSL7 01		

relay sockets



GEV No.	380137	Ref. No.	27193
description	relay socket 8-pole connection plug-in connection round 8-pole dimensions 65x28x40mm 380V voltage AC 10A Italiana Relè manuf. no. ZVE8		
For models:	APS43, APS48, APS53, APS60, BPS43, ED600-95, ED630-90, ED650S, ED650S-90, ED700-90, ED900-90, FW35, FW40, FW45, FW50, LO122, LO60, LO78		
accessories for	380137		
	GEV No.	380805	Ref. No. —
	support bracket		

relays

power relays

with bracket mounting



GEV No.	380627	Ref. No.	33324 34312
description	power relays 230VAC 16A 2CO connection male faston bracket mounting		
For models:	60EBT, APS43, APS48, APS53, APS60, C35, C43, C43-2, C43ALTA, C43D, C48, C48-2, C48D, C48D-2, C48DDL, C48DL, C53, C53D, C6, C60, C60D, C68EBT, C6D, CA55, CAP7, CDN3, CDN4, CR43, CR43D, CR48, CR48D, DP35, DP35-2, DP35D, DP35D-2, DP40, DP40-2, DP40D, DP40D-2, DP40D-rib2, DP40-rib2, DP45, DP45D, DP50, DP50D, ED550, FW35, FW40, FW45, FW50...(Other models you can see in the webshop)		

level relays

GICAR



GEV No.	400048	Ref. No.	27434
description	level relay 1CO 230V voltage AC connection plug-in connection round 8-pole type 27434		
For models:	APS43, APS48, APS53, APS60, ED600-95, ED630-90, ED650S, ED650S-90, ED700-90, ED900-90, FW35, FW40, FW45, FW50, LO122, LO60, LO78		



pulse relays

			
1			
GEV No.	381195	Ref. No.	120493 H120493
description	pulse relay voltage AC/DC 1CO 250V 16A connection screw clamp DIN rail		
For models:	HT100, HT150, HTP195, HTP205, HTP220, TR100, TR230, TR90, TR-E100, TR-E150, TR-E200, TR-E230, TR-E90		

time relays

<p>time relays</p> 			
1			
GEV No.	360465	Ref. No.	25408
description	time relay FIBER T45 time range 0s-120h 230VAC 5/2A mounting measurements 45x45mm 2CO		
For models:	ED600-95, ED700, ED700-90, ED900, ED900-90, LO122, LO60, LO78		
accessories for	360465		
		GEV No.	360485
		Ref. No.	—
	mounting frame L 72mm W 72mm for time relay for model E47,E48,E58,E59,T45,C58,C59		

probes

producer-specific probes

<p>probes</p> 			
1			
GEV No.	380938	Ref. No.	H120910
description	probe Pt100 cable silicone probe -100 up to 450°C cable -50 up to +180°C connection plug thread 1/2" probe ø6x70mm cable length 6.5m		
accessories for	380938		
		GEV No.	510355
		Ref. No.	33372 460501
	gasket fibre ED ø 24mm ID ø 17mm thickness 2mm Qty 1 pcs		

Зип Общепит

vsezip.ru

+7(812)987-08-81

			
GEV No.	379908	Ref. No.	33174
description	temperature probe NTC		
For models:	APSE43, APSE48, APSE53, APSE60, C81, C90, CA120, CA90, ED650E, ED650S, EDI13, EDI13ALTA, EDI6, EDI8, LO134, LO134ALTA, LO50, LO67, LO83, SP81, US-X501		

			
1			
GEV No.	378006	Ref. No.	120960 34945 35567
description	temperature probe NTC 40kOhm cable PVC probe -40 up to +110°C cable -10 up to 100°C connection F6.3 thread probe ø4x20mm cable length 0.25m		
For models:	AP43E, AP48E, AP53E, AP60E, APS43, APS48, APS48B, APS53, APS60, C81, C81E, C81EBT, C90, C90DE, C90DE2, C90E, C90E2, C90EBT, C90EBT2, CA120, CA90, CAP10, CAP10BT, CAP10DE, CAP12, CAP12DE, CAP12EBT, CAP7E, DP45DE, DP45E, DP50DE, DP50E, DP50EBT, ED650E, ED650S, EDI13, EDI13-2, EDI13ALTA, EDI13ALTA-2, EDI13AL-TABT, EDI13BT, EDI4, EDI6, EDI6-2, EDI6BT, EDI8, EDI8-2, EDI8BT, FW35, FW35E...(Other models you can see in the webshop)		

electronics

EPROMS

			
1			
GEV No.	401887	Ref. No.	35562
description	micro processor CODE DWSAP240203		
For models:	APS43, APS48, APS48B, APS53, APS60, FW35, FW40, FW40B, FW45, FW50		

			
1			
GEV No.	402840	Ref. No.	35565
description	micro processor suitable for HOONVED CODE DWEDCAP 031002		
For models:	CA120, CA90, ED650E, ED650S		

electric components



PCBs

Зип Общепит

vsezip.ru

+7(812)987-08-81

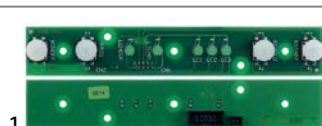

GEV No.	403730	Ref. No.	37676
description	control PCB L 175mm W 30mm		
For models:	CAP7E, SO55E		



GEV No.	402929	Ref. No.	121306 37576
description	display PCB dishwasher DP45/50 L 85mm W 28mm green 4 digits		
For models:	CAP7E, DP45DE, DP45E, DP50DE, DP50E, DP50EBT, ST43DE, ST43E, ST48DE, ST48E, ST48EBT, ST53DE, ST53E, ST60DE, ST60E, ST60EBT		



GEV No.	402805	Ref. No.	36490
description	keypad PCB dishwasher 60EBT/C43DE buttons 3		
For models:	60EBT, C43DE, C43E, C46DE, C46E, C53DE, C53E, C60DE, C60E, C68DE, C68E, C68EBT, C6DE, C6E, C6EBT, SP35DE, SP35E, SP40DE, SP40E, SP45DE, SP45E, SP50DE, SP50E, SP50E-400V3-50Hz-MARINE, SP50E-440V3-60Hz-MARINE, SP5DE, SP5E, SP68DE, SP68E		
accessories for	402805		
	GEV No.	Ref. No.	110492 110498 36492
ribbon cable 10-pole L 500mm plug type FC-10P raster size 2.54mm			



GEV No.	402908	Ref. No.	36339
description	keypad PCB dishwasher C81/90 suitable for HOONVED with display buttons 4		
For models:	C81E, C90DE, C90E, C90EBT, CAP10, CAP10BT, CAP12, LO50E, SMW15E, SO100, SO100-400V3-50Hz-MARINE, SO100-440V3-60Hz-MARINE, SO120, SP81E		



GEV No.	402928	Ref. No.	121305 37575
description	keypad unit L 170mm W 28mm with LED buttons 4		
For models:	DP45DE, DP45E, DP50DE, DP50E, ST43DE, ST43E, ST48DE, ST48E, ST53DE, ST53E, ST60DE, ST60E, ST60EBT		



GEV No.	400944	Ref. No.	121237 H121237
description	PCB		
For models:	GS-X1011, GS-X1011-2, GS-X1011-WEH, GS-X1011-WEH-2, GS-X1021, GS-X1021-2, GS-X1021-2rib, GS-X1021-WEH, GS-X1021-WEH-2, GS-X1021-WEH-2rib		



GEV No.	400950	Ref. No.	34514
description	PCB		
For models:	CA120, CA90, ED650E, ED650S		



GEV No.	400951	Ref. No.	33173
description	PCB		
For models:	APS43, APS48, APS48B, APS53, APS60, APSE43, APSE48, APSE53, APSE60, C81, FW35, FW40, FW40B, FW45, FW50, SP81		

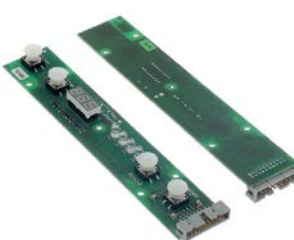

GEV No.	698575	Ref. No.	H121300
description	PCB dishwasher AP43/48-FW35/40E L 184mm W 34mm		
For models:	AP43E, AP48E, AP53E, AP60E, C81E, C90DE2, C90EBT2, CAP10, CAP10BT, CAP12, FW35E, FW40E, SO100, SO120		



Зип Общепит

vsezip.ru

+7(812)987-08-81



1

GEV No.	401902	Ref. No.	H121291
description	PCB dishwasher BAC30E		
For models:	60EBT, C43DE, C43E, C46DE, C46E, C53DE, C53E, C60DE, C60E, C68DE, C68E, C68EBT, C6DE, C6E, SP35DE, SP35E, SP40DE, SP40E, SP45DE, SP45E, SP50DE, SP50E, SP50E-400V3-50Hz-MARINE, SP50E-440V3-60Hz-MARINE, SP5DE, SP5E, SP68DE, SP68E		



1

GEV No.	402881	Ref. No.	121284 H121284
description	PCB dishwasher CE-GE L 126mm W 63mm suitable for COMENDA		



1

GEV No.	402864	Ref. No.	37949
description	PCB dishwasher C35E L 85mm W 70mm model since February 2013 type 8.5.65.99		
For models:	C35E, SPB35E		



1

GEV No.	401846	Ref. No.	H121287
description	PCB dishwasher COMENDA, HOONVED		
For models:	C48E, CAP7, SO55, SO55-400V3-50Hz-MARINE, SO55-440V3-60Hz-MARINE, SP40E		



1

GEV No.	400943	Ref. No.	121239 H121239
description	PCB dishwasher C75/C155		
For models:	60BT, 60BT-3, SD5BT		



1

GEV No.	402926	Ref. No.	121307 37577 37904 H37904
description	PCB dishwasher DP40/DP45 L 100mm W 100mm for dishwasher		
For models:	DP45DE, DP45E, DP50DE, DP50E, ST43DE, ST43E, ST48DE, ST48E, ST53DE, ST53E, ST60DE, ST60E, ST60EBT		



1

GEV No.	403763	Ref. No.	121322
description	PCB dishwasher CAP7E/SO55E L 100mm W 100mm		
For models:	CAP7E		



1

GEV No.	402695	Ref. No.	H121283
description	PCB dishwasher L 145mm W 105mm HOONVED		
For models:	C81E, C90DE, C90DE2, C90E, C90EBT, C90EBT2, CAP10, CAP10BT, CAP12, EDI13-2, EDI13ALTA-2, EDI13ALTABT, EDI13BT, EDI4, EDI6-2, EDI6BT, EDI8-2, EDI8BT, LO134-2, LO134ALTA-2, LO50E, LO56, LO67-2, LO83-2, SMW15E, SO100, SO100-400V3-50Hz-MARINE, SO100-440V3-60Hz-MARINE, SO120, SP81E		



Зип.Общепит

solenoid valves
vsezip.ru

+7(812)987-08-81



1

GEV No.	403272	Ref. No.	34842
description	PCB for dishwasher EDI13 L 145mm W 95mm Qty 1 pcs		
For models:	EDI13, EDI13ALTA, EDI6, EDI8, LO134, LO134ALTA, LO67, LO83, RLO200, RLO300, RLO400		



1

GEV No.	403049	Ref. No.	35785
description	PCB L 145mm W 95mm 230V without EPROM		
For models:	C90, LO50, RLO50, SMW15		

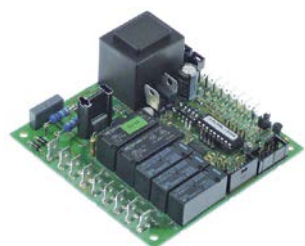

1

GEV No.	403274	Ref. No.	38062
description	PCB warewashing CAP7E/SO55E L 100mm W 100mm Qty 1 pcs		
For models:	CAP7E, SO55E		

keypads

front foils



1

GEV No.	403328	Ref. No.	33713
description	front foil dishwasher C43 suitable for HOONVED L 420mm W 45mm		
For models:	C43, C43-2, C43ALTA, C43D, C48DDL, C48DL, C53D, CR43, CR43D, CR48, SP35, SP35ALTA, SP35D, SP40DDL, SP40DL, SP45D, SPR36, SPR36D, SPR41		



1

GEV No.	402925	Ref. No.	36134 463298
description	keypad foil dishwasher 60EBT/C43DE blue suitable for HOONVED L 256mm W 37mm buttons 3		
For models:	60EBT, C43DE, C43E, C46DE, C46E, C53DE, C53E, C60DE, C60E, C68DE, C68E, C68EBT, C6DE, C6E, C6EBT, SP35DE, SP35E, SP40DE, SP40E, SP45DE, SP45E, SP50DE, SP50E, SP68DE, SP68E		

solenoid valves (water)



1

GEV No.	370021	Ref. No.	26631
description	solenoid valve double straight 230VAC inlet 3/4" outlet 11.5mm DN10 TP flow regulating valve inlet white		
For models:	C43D, C43DE, C46DE, C46E, C48D, C48D-2, C48DDL, C48E, C53D, C53DE, C60D, C60DE, C68DE, C68E, C6D, C6DE, C90DE, C90DE2, CAP10DE, CAP12DE, CM43, CM48, CM52, CM60, CR43D, CR48D, DP35, DP35-2, DP35D, DP40, DP40-2, DP40D, DP40-rib2, DP45, DP45D, DP45DE, DP50, DP50D, DP50DE, E36, E40, E40-2F, E43, E50, GS-X1011, GS-X1011-2, GS-X1011-WEH, GS-X1011-WEH-2, GS-X1021, GS-X1021-2...(Other models you can see in the webshop)		

spare parts for	370021			
	GEV No.	371013	Ref. No.	—
	solenoid coil TP 230VAC 50/60Hz			

accessories for	370021		
------------------------	--------	--	--

	GEV No.	371220	Ref. No.	—
	reducer TP flow rate 3l/min red tolerance ±15%			

	GEV No.	371221	Ref. No.	—
	reducer TP flow rate 5.5l/min yellow tolerance ±15%			

	GEV No.	371222	Ref. No.	—
	reducer TP flow rate 6l/min grey tolerance ±15%			

	GEV No.	371223	Ref. No.	—
	reducer TP flow rate 10l/min white tolerance ±15%			

	GEV No.	371224	Ref. No.	—
	reducer TP flow rate 12l/min bronze tolerance ±15%			

	GEV No.	371225	Ref. No.	—
	reducer TP flow rate 16l/min light brown tolerance ±15%			

	GEV No.	371226	Ref. No.	—
	reducer TP flow rate 20l/min red tolerance ±15%			

	GEV No.	371230	Ref. No.	—
	reducer TP flow rate 0.25l/min red tolerance ±25%			

	GEV No.	371231	Ref. No.	—
	reducer TP flow rate 0.35l/min violet tolerance ±25%			

	GEV No.	371232	Ref. No.	—
	reducer TP flow rate 0.5l/min orange tolerance ±25%			

	GEV No.	371233	Ref. No.	—
	reducer TP flow rate 0.8l/min white tolerance ±25%			



Table continues overleaf











Зип-Общепит

vsezip.ru

+7(812)987-08-81

accessories for		370021		
GEV No.	Ref. No.	Ref. No.	Ref. No.	Ref. No.
	371234	—	—	—
reducer TP flow rate 1l/min light blue tolerance ±25%				
	371235	—	—	—
reducer TP flow rate 1.2l/min brown tolerance ±25%				
	371236	—	—	—
reducer TP flow rate 1.5l/min light brown tolerance ±25%				
	371237	—	—	—
reducer TP flow rate 2.5l/min yellow tolerance ±25%				
	371238	—	—	—
reducer TP flow rate 3.4l/min dark green tolerance ±25%				
	371239	—	—	—
reducer TP flow rate 5l/min black tolerance ±25%				
	371240	—	—	—
reducer TP flow rate 8l/min blue tolerance ±20%				

accessories for		370017		
GEV No.	Ref. No.	Ref. No.	Ref. No.	Ref. No.
	371226	—	—	—
reducer TP flow rate 20l/min red tolerance ±15%				
	371230	—	—	—
reducer TP flow rate 0.2l/min red tolerance ±25%				
	371231	—	—	—
reducer TP flow rate 0.35l/min violet tolerance ±25%				
	371232	—	—	—
reducer TP flow rate 0.5l/min orange tolerance ±25%				
	371233	—	—	—
reducer TP flow rate 0.8l/min white tolerance ±25%				
	371234	—	—	—
reducer TP flow rate 1l/min light blue tolerance ±25%				
	371235	—	—	—
reducer TP flow rate 1.2l/min brown tolerance ±25%				
	371236	—	—	—
reducer TP flow rate 1.5l/min light brown tolerance ±25%				
	371237	—	—	—
reducer TP flow rate 2.5l/min yellow tolerance ±25%				
	371238	—	—	—
reducer TP flow rate 3.4l/min dark green tolerance ±25%				
	371239	—	—	—
reducer TP flow rate 5l/min black tolerance ±25%				
	371240	—	—	—
reducer TP flow rate 8l/min blue tolerance ±20%				

 				
GEV No.	370017	Ref. No.	26629	
description	solenoid valve single straight 230VAC inlet 3/4" outlet 11.5mm DN10 TP p max 10bar			
For models:	60BT, 60BT-3, 60EBT, AP43E, AP48E, AP53E, AP60E, C3, C35, C35E, C4, C43, C43-2, C43ALTA, C43D, C43E, C46E, C48, C48-2, C48D, C48DDL, C48DL, C48E, C53, C53D, C53E, C6, C60, C60D, C60E, C68DE, C68E, C68EBT, C6D, C6E, CAP10BT, CR43, CR43D, CR48, CR48D, DP45E, DP50D-115V, DP50E, E36, ED650E, ED650E-90, ED650S, FW35E, FW40E, GS-X1011...(Other models you can see in the webshop)			
spare parts for	370017			
	GEV No.	371013	Ref. No.	—
solenoid coil TP 230VAC 50/60Hz				
accessories for	370017			
	GEV No.	371220	Ref. No.	—
reducer TP flow rate 3l/min red tolerance ±15%				
	GEV No.	371221	Ref. No.	—
reducer TP flow rate 5.5l/min yellow tolerance ±15%				
	GEV No.	371222	Ref. No.	—
reducer TP flow rate 6l/min grey tolerance ±15%				
	GEV No.	371223	Ref. No.	—
reducer TP flow rate 10l/min white tolerance ±15%				
	GEV No.	371224	Ref. No.	—
reducer TP flow rate 12l/min bronze tolerance ±15%				
	GEV No.	371225	Ref. No.	—
reducer TP flow rate 16l/min light brown tolerance ±15%				



 				
GEV No.	370015	Ref. No.	30933 30993 H120145	
description	solenoid valve single angled 230VAC inlet 3/4" outlet 11.5mm DN10 TP			
For models:	APS43, APS48, APS48B, APS53, APS60, APSE43, APSE48, APSE53, APSE60, BPN48, BPS43, BPS52, C81, C81E, C81EBT, C90, C90E, C90E2, C90EBT, C90EBT2, CA120, CA55, CA90, CAP10, CAP12, CAP7, CAP7E, ED550, ED650E, ED650S, EDI4, FW35, FW40, FW40B, FW45, FW50, INDY48F, LO50, LO50E, LO56, RCA1100, RCA1200, RCA1200i, RLO50, SMW15, SMW15E, SO100, SO100-400V3-50Hz-MARINE, SO100-440V3-60Hz-MARINE, SO120...(Other models you can see in the webshop)			
accessories for	370015			
	GEV No.	371220	Ref. No.	—
reducer TP flow rate 3l/min red tolerance ±15%				

Table continues overleaf

1 electric components

Зип Общепит

vsezip.ru

+7(812)987-08-81



GEV No.	370023	Ref. No.	26632
description	solenoid valve triple angled 230VAC inlet 3/4" outlet 11.5mm DN10 TP		
For models:	CDN3, CDN4, CMD43, CMD48, CMD52, CMD60, DP35D, DP35D-2, DP40D, DP40D-2, DP40D-rib2, DP45D, DP50D, GS-X1021, GS-X1021-2, GS-X1021-2rib, GS-X1021-WEH, GS-X1021-WEH-2, GS-X1021-WEH-2rib, NKD43, NKD48, NKD60, STS43D, STS43D-2, STS48D, STS48D-2, STS48D-rib2, STS53D, STS60D, TDN4-2rib, TN-TDN5, TN-TDN6, UNI43RD, UNI48CD, UNI48RD, UNI53RD		
spare parts for	370023		
	GEV No.	371013	Ref. No.
			—
	solenoid coil TP 230VAC 50/60Hz		
accessories for	370023		
	GEV No.	371220	Ref. No.
			—
	reducer TP flow rate 3l/min red tolerance ±15%		
	GEV No.	371221	Ref. No.
			—
	reducer TP flow rate 5.5l/min yellow tolerance ±15%		
	GEV No.	371222	Ref. No.
			—
	reducer TP flow rate 6l/min grey tolerance ±15%		
	GEV No.	371223	Ref. No.
			—
	reducer TP flow rate 10l/min white tolerance ±15%		
	GEV No.	371224	Ref. No.
			—
	reducer TP flow rate 12l/min bronze tolerance ±15%		
	GEV No.	371225	Ref. No.
			—
	reducer TP flow rate 16l/min light brown tolerance ±15%		
	GEV No.	371226	Ref. No.
			—
	reducer TP flow rate 20l/min red tolerance ±15%		
	GEV No.	371230	Ref. No.
			—
	reducer TP flow rate 0.25l/min red tolerance ±25%		
	GEV No.	371231	Ref. No.
			—
	reducer TP flow rate 0.35l/min violet tolerance ±25%		
	GEV No.	371232	Ref. No.
			—
	reducer TP flow rate 0.5l/min orange tolerance ±25%		
	GEV No.	371233	Ref. No.
			—
	reducer TP flow rate 0.8l/min white tolerance ±25%		
	GEV No.	371234	Ref. No.
			—
	reducer TP flow rate 1l/min light blue tolerance ±25%		
	GEV No.	371235	Ref. No.
			—
	reducer TP flow rate 1.2l/min brown tolerance ±25%		

Table continues overleaf





accessories for	370015		
	GEV No.	371221	Ref. No.
			—
	reducer TP flow rate 5.5l/min yellow tolerance ±15%		
	GEV No.	371222	Ref. No.
			—
	reducer TP flow rate 6l/min grey tolerance ±15%		
	GEV No.	371223	Ref. No.
			—
	reducer TP flow rate 10l/min white tolerance ±15%		
	GEV No.	371224	Ref. No.
			—
	reducer TP flow rate 12l/min bronze tolerance ±15%		
	GEV No.	371225	Ref. No.
			—
	reducer TP flow rate 16l/min light brown tolerance ±15%		
	GEV No.	371226	Ref. No.
			—
	reducer TP flow rate 20l/min red tolerance ±15%		
	GEV No.	371230	Ref. No.
			—
	reducer TP flow rate 0.25l/min red tolerance ±25%		
	GEV No.	371231	Ref. No.
			—
	reducer TP flow rate 0.35l/min violet tolerance ±25%		
	GEV No.	371232	Ref. No.
			—
	reducer TP flow rate 0.5l/min orange tolerance ±25%		
	GEV No.	371233	Ref. No.
			—
	reducer TP flow rate 0.8l/min white tolerance ±25%		
	GEV No.	371234	Ref. No.
			—
	reducer TP flow rate 1l/min light blue tolerance ±25%		
	GEV No.	371235	Ref. No.
			—
	reducer TP flow rate 1.2l/min brown tolerance ±25%		
	GEV No.	371236	Ref. No.
			—
	reducer TP flow rate 1.5l/min light brown tolerance ±25%		
	GEV No.	371237	Ref. No.
			—
	reducer TP flow rate 2.5l/min yellow tolerance ±25%		
	GEV No.	371238	Ref. No.
			—
	reducer TP flow rate 3.4l/min dark green tolerance ±25%		
	GEV No.	371239	Ref. No.
			—
	reducer TP flow rate 5l/min black tolerance ±25%		
	GEV No.	371240	Ref. No.
			—
	reducer TP flow rate 8l/min blue tolerance ±20%		





Зип Общепит





vsezip.ru

+7(812)987-08-81

accessories for		370023	
	GEV No.	371236	Ref. No. —
reducer TP flow rate 1.5l/min light brown tolerance ±25%			
	GEV No.	371237	Ref. No. —
reducer TP flow rate 2.5l/min yellow tolerance ±25%			
	GEV No.	371238	Ref. No. —
reducer TP flow rate 3.4l/min dark green tolerance ±25%			
	GEV No.	371239	Ref. No. —
reducer TP flow rate 5l/min black tolerance ±25%			
	GEV No.	371240	Ref. No. —
reducer TP flow rate 8l/min blue tolerance ±20%			

			
1	GEV No.	370643	Ref. No. 25305
description solenoid valve 2-ways 230VAC inlet 3/4" outlet 3/4" L 100mm with flange slide-on receptacle DIN BÜRKERT membranes NBR p max 16bar p min 0.2bar 50/60Hz brass			
For models: ED600-95, ED630-90, ED700-90, EDI6, EDI6-2, LO60, LO67, LO67-2, RLO200			

solenoid valves with reducers			
			
1	GEV No.	370245	Ref. No. LF-3120530
description solenoid valve single straight 24VAC inlet 3/4" outlet 11.5mm input 16l/min t.max. 90°C TP plastic flow regulating valve inlet light brown			

SIRAI			
2-way			
L140-B series			
			
1	GEV No.	370320	Ref. No. 120141 H120141
description solenoid valve brass 2-ways 24VAC inlet 1/2" outlet 1/2" connection 1/2" L 41mm DN 10mm slide-on receptacle compact -10 up to +90°C SIRAI type series L140-B coil type Z610A membranes NBR (water) p max 12bar p min 0.35bar			
For models: AC101, AC151, AC181, AC201, AC241, AC91, EDT100, EDT140, EDT170, EDT200, EDT230, EDT85, TR100, TR140, TR170, TR200, TR230, TR90, TR-E100, TR-E150, TR-E170, TR-E200, TR-E230, TR-E90			
spare parts for 370320			
	GEV No.	371070	Ref. No. —
solenoid coil 24VAC 10VA SIRAI coil type Z610A seat ø 10mm			
	GEV No.	371163	Ref. No. —
membrane connection 1/2" series L140-B membrane type NBR (water)			
accessories for 370320			
	GEV No.	371091	Ref. No. —
power socket plug type DIN 43650B cable lengthmm small			

metal			
BÜRKERT			
2-way			
6213 series			
			
1	GEV No.	370627	Ref. No. 27132
description solenoid valve 2-ways 230VAC connection 3/4" L 58mm DN 13mm slide-on receptacle DIN type series 6213 membranes NBR p max 10bar 50Hz brass			
For models: ED700-90, ED900-90, EDI13, EDI13-2, EDI13ALTA, EDI13ALTA-2, EDI8, EDI8-2, LO122, LO134, LO134-2, LO134ALTA, LO134ALTA-2, LO78, LO83, LO83-2, RLO300, RLO400			

electric components



Зип-Общепит
vsezip.ru
+7(812)987-08-81

L180-B series



1

GEV No.	370391	Ref. No.	120122 H120122
description	solenoid valve 2-ways 24VAC connection 3/4" L 79mm DN 18mm -10 up to +90°C coil type Z610A membranes NBR (water) p max 12bar p min 0.35bar		
For models:	AC101, AC151, AC181, AC201, AC241, AC91, EDT100, EDT140, EDT170, EDT200, EDT230, EDT85		
accessories for	370391		
	GEV No.	371091	Ref. No. —
power socket plug type DIN 43650B cable lengthmm small			





1

GEV No.	370329	Ref. No.	120131 H120131
description	solenoid valve 2-ways 24VAC inlet 1/2" outlet 1/2" connection 1/2" L 66mm DN 13.5mm slide-on receptacle compact -10 up to +90°C SIRAI type series L180-B coil type Z610A membranes NBR (water) p max 12bar p min 0.35bar		
For models:	AC101, AC151, AC181, AC201, AC241, AC91, EDT100, EDT140, EDT170, EDT200, EDT230, EDT85, HG2LR, HGLR, TR-E100, TR-E150, TR-E170, TR-E200, TR-E230, TR-E90		
spare parts for	370329		
	GEV No.	371070	Ref. No. —
solenoid coil 24VAC 10VA SIRAI coil type Z610A seat ø 10mm			
	GEV No.	371171	Ref. No. —
membrane series L180-B membrane type NBR (water)			
accessories for	370329		
	GEV No.	371091	Ref. No. —
power socket plug type DIN 43650B cable lengthmm small			



1

GEV No.	370047	Ref. No.	120174 H120174
description	solenoid valve brass 2-ways 230VAC inlet 1/2" outlet 1/2" connection 1/2" L 66mm DN 13.5mm slide-on receptacle compact -10 up to +90°C SIRAI type series L180-B coil type Z610A membranes NBR (water) p max 12bar p min 0.35bar 50/60Hz		
For models:	EDI13ALTABT, EDI13BT, EDI6BT, EDI8BT		
spare parts for	370047		
	GEV No.	371085	Ref. No. —
solenoid coil 230VAC 4VA SIRAI coil type ZB10A seat ø 10mm 50/60Hz			

GEV No.	371171	Ref. No.	—
membrane series L180-B membrane type NBR (water)			
accessories for	370047		
	GEV No.	371091	Ref. No. —
power socket plug type DIN 43650B cable lengthmm small			

solenoid valves steam (water)

2-way

L140-D series



1

GEV No.	370625	Ref. No.	37906
description	solenoid valve brass 2-ways 230VAC inlet 1/2" outlet 1/2" connection 1/2" L 41mm DN 10mm slide-on receptacle compact -10 up to 100°C SIRAI type series L140-D coil type Z610A membranes EPDM p max 10bar p min 0.35bar 50/60Hz		

Solenoid valve - accessories

filters



1

GEV No.	503139	Ref. No.	26981
description	solenoid valve filter ø 19.5mm H 16mm		
For models:	APS43, APS48, APS48B, APS53, APS60, APSE43, APSE48, APSE53, APSE60, BPN48, BPS43, BPS52, C35, C43, C43ALTA, C43D, C48, C48D, C48DDL, C48DL, C53, C53D, C6, C60, C60D, C6D, C81, C81E, C90, C90E, CA120, CA55, CA90, CAP7, CAP7E, CM43, CM48, CM52, CM60, CMD43, CMD48, CMD52, CMD60, CR43, CR43D, CR48, CR48D, DP35, DP35D, DP40...(Other models you can see in the webshop)		



1

GEV No.	512030	Ref. No.	37907
description	fastening angle for solenoid valve suitable for HOONVED		



pressure switches

for warewashing

ø 58mm with male faston 6.3mm

with connection horizontal



GEV No.	541011	Ref. No.	130609 130624 130928 H130609
description	pressure control pressure range 110/70mbar connection 6mm ø 58mm pressure connection horizontal warewashing		
For models:	AC151, AC181, AC201, AC241, EDT140, EDT170, EDT200, EDT230, HD130BT, HD40ALTABT, HD40BT, HD60BT, HD80BT, HG2LR, HGLR, HT100, HT150, HTP195, HTP205, HTP220		



GEV No.	541972	Ref. No.	130635 H130635
description	pressure control pressure range 190/40mbar connection male faston 6.3mm ø 58mm pressure connection horizontal warewashing pressure connection ø 5.5mm		
For models:	C90DE2, C90E2, C90EBT2, EDI4, HD130BT, HD40ALTABT, HD40BT, HD60BT, HD80BT, LO56		



GEV No.	541045	Ref. No.	31171
description	pressure control pressure range 28/12mbar connection 6mm ø 58mm pressure connection horizontal warewashing		
For models:	60BT, 60BT-3, 60EBT, APS43, APS48, APS48B, APS53, APS60, APSE43, APSE48, APSE53, APSE60, C3, C35, C35E, C4, C43, C43-2, C43ALTA, C43D, C43DE, C43E, C46DE, C46E, C48, C48-2, C48D, C48D-2, C48DDL, C48DL, C48E, C53, C53D, C53DE, C53E, C60, C60D, C60DE, C60E, C68DE, C68E, C68EBT, C6DE, C6E, C6EBT, C81E, C81EBT, CDN3, CDN4, CR43...(Other models you can see in the webshop)		



GEV No.	541039	Ref. No.	130621 H130621
description	pressure control pressure range 45/25mbar connection 6mm ø 58mm pressure connection horizontal warewashing		
For models:	C90DE, C90EBT		

Зип Общепит

vsezip.ru

+7(812)987-08-81



GEV No.	541024	Ref. No.	25432
description	pressure control pressure range 60/40mbar connection 6mm ø 58mm pressure connection horizontal warewashing pressure connection ø 6mm		
For models:	C98, CA55, CAP7, CAP7E, CM48, CM52, CM60, CMD48, CMD52, ED550, LO62, M60, NK48, NK60, NKD48, NKD52, RCA1100, RCA1200, RCA1200i, SO55, SO55-400V3-50Hz-MARINE, SO55-440V3-60Hz-MARINE, SO55E, T6-80, UNI43R, UNI43RD, UNI48R, UNI48RD, UNI53R, UNI53RD		



GEV No.	541631	Ref. No.	130632 H130632
description	pressure control pressure range 75/45mbar connection 6mm ø 55mm pressure connection ø 5.5mm		
For models:	CAP10, CAP10BT, CAP10DE, CAP12, CAP12DE, CAP12EBT, CAP7E, SO100, SO100-400V3-50Hz-MARINE, SO100-440V3-60Hz-MARINE, SO120		

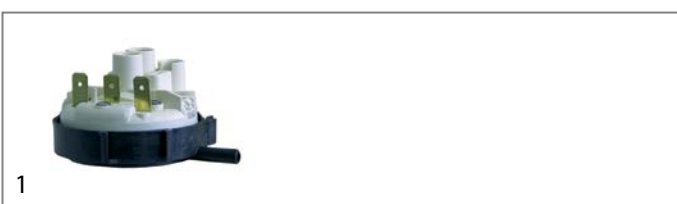

GEV No.	541017	Ref. No.	25433
description	pressure control with mounting strap pressure range 40/20mbar connection 6mm ø 58mm pressure connection horizontal warewashing		
For models:	60BT, BPN48, BPS43, BPS52, CM43, CMD43, E36, E40, E43, K80F, K80G, NK43, NKD43, SD5BT, T3-80, T4-80, T5-80		

ø 84mm with coded plug



GEV No.	541308	Ref. No.	130628 H130628
description	pressure control 3 pressure ranges pressure range 50/30 50/30 110/70mbar connection 6mm ø 84mm pressure connection horizontal warewashing suitable for COMENDA pressure connection ø 6mm		
For models:	60BT, 60BT-3, C81EBT, C90EBT, C90EBT2, CAP10BT, CAP12EBT, CAP15EBT, EDI13ALTABT, EDI13BT, EDI4, EDI6BT, EDI8BT, LO56, SD5BT		

1 electric components



Зип Общепит

vsezip.ru

+7(812)987-08-81



1

GEV No.	541674	Ref. No.	130620 H130620
description	pressure control 3 pressure ranges pressure range 50/30 50/30 160/80mbar connection 6mm ø 84mm pressure connection horizontal warewashing suitable for COMENDA, HOONVED pressure connection ø 6mm		
For models:	AC101, AC151, AC181, AC201, AC241, AC91, EDI13ALTABT, EDI13BT, EDI6BT, EDI8BT, EDT100, EDT140, EDT170, EDT200, EDT230, EDT85, HG2LR, HGLR, HT100, HT150, HTP195, HTP205, HTP220, TR100, TR140, TR170, TR200, TR230, TR90, TR-E100, TR-E150, TR-E170, TR-E200, TR-E230, TR-E90		



1

GEV No.	361385	Ref. No.	32311
description	level electrode 1/8" total length 55mm probe L 40x40mm insulated probe length 15mm curved 90° connection M4 ø 13mm		
For models:	AP43E, AP48E, AP53E, AP60E, APS43, APS48, APS48B, APS53, APS60, APSE43, APSE48, APSE53, APSE60, FW35, FW35E, FW40, FW40B, FW40E, FW45, FW50		

miscellaneous



1

GEV No.	541517	Ref. No.	37822
description	pressure control ø 37mm pressure connection ø 4mm		



1

GEV No.	361386	Ref. No.	33431 35361
description	level electrode 1/8" total length 95mm probe L 82mm insulated probe length 15mm connection M4 ø 4mm		
For models:	C81, C90, C90E, CA120, CA90, ED650E, ED650S, LO50, LO50E, RLO50, SMW15, SMW15E, SP81, US-X501		



1

GEV No.	541325	Ref. No.	30687
description	pressure control pressure range 4.5mbar		
For models:	60BT, APS43, APS48, APS48B, APS53, APS60, APSE43, APSE48, APSE53, APSE60, BPN48, BPS43, BPS52, CA120, ED600-95, ED630-90, ED650S, ED700-90, FW35, FW40, FW40B, FW45, FW50, LO60, LO78, SD5BT		



1

GEV No.	400164	Ref. No.	27198
description	level electrode M10x1.5 probe L 2mm ø 4mm		
For models:	ED600-95, ED700-90, ED900-90, EDI5, LO122, LO60, LO61, LO78		
accessories for	400164		
	GEV No.	Ref. No.	512376 25266
	flat gasket rubber ED ø 18mm ID ø 10mm thickness 2mm Qty 1 pcs		

electrodes



1

GEV No.	512072	Ref. No.	25042
description	level electrode 1/2" total length 78.5mm probe L 63mm insulated probe length 54mm connection M5x0.8 plastic ø 26mm		
For models:	ED600-95, ED630-90, ED650S, ED650S-90, ED700, ED700-90, ED900, ED900-90, EDI13, EDI13-2, EDI13ALTA, EDI13ALTA-2, EDI6, EDI6-2, EDI8, EDI8-2, LO122, LO134, LO134-2, LO134ALTA, LO134ALTA-2, LO60, LO67, LO67-2, LO78, LO83, LO83-2, RLO200, RLO300, RLO400		

motors

gear motors

for dishwashers



1

GEV No.	601665	Ref. No.	100246 H100246
description	gear motor NORD type SK 01-71L/6-4 0.10/0.15W 400V 50Hz 3 phase 12.2/18.8rpm shaft ø 19mm L 363mm speeds 2		
For models:	AC101, AC151, AC181, AC201, AC241, AC91, EDT100, EDT140, EDT170, EDT200, EDT230, EDT85, TR100, TR140, TR170, TR200, TR230, TR90, TR-E100, TR-E150, TR-E170, TR-E200, TR-E230		

pumps



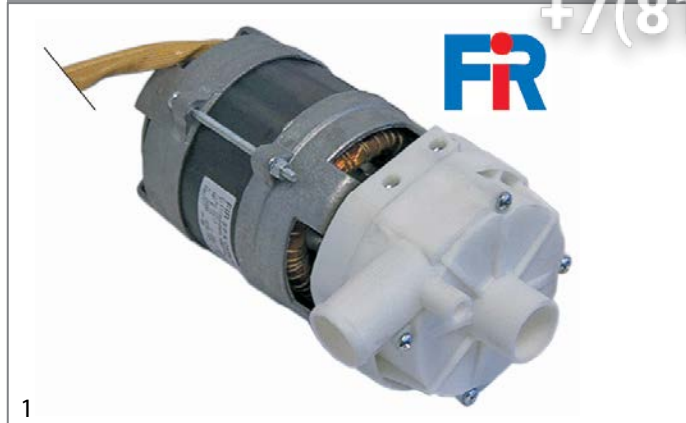

wash and rinse pumps

FIR

pumps



1

GEV No.	500037	Ref. No.	100747 H100747
description	pump inlet ø 28mm outlet ø 26mm type 2211.1410 230V 50Hz 1 phase 0.074kW 0.1HP L 190mm rotation direction left capacitor 5µF FIR		
For models:	60BT, SD5BT		
spare parts for	500037		
	GEV No.	365017	Ref. No. 32712 33543
	operating capacitor capacity 5µF 450V tolerance 5% 50/60Hz ambient temperature max. -25 to +85°C ø 28mm L 54mm M8 plastic connection male faston 6.3mm 16.10.08 protection		
	GEV No.	510384	Ref. No. —
	pump cover inlet ø 28mm outlet ø 26mm ø 100mm ID ø 76mm		
	GEV No.	510695	Ref. No. 34226
	mechanical shaft seal height counter ring 5.5mm ID ø 11mm		
	GEV No.	521203	Ref. No. —
	impellor ø 72mm H 18mm thread M7 shaft ø 11mm shaft length 32mm blades 3		
	GEV No.	521703	Ref. No. 34224
	pump cover gasket EPDM thickness 2.5mm ID ø 75mm Qty 1 pcs		





Зип Общепит

vsezip.ru

+7(812)987-08-81



1

GEV No.	500030	Ref. No.	N/A
description	pump inlet ø 28mm outlet ø 26mm type 4226.2540 230/400V 50Hz 3 phase 0.35kW 0.5HP L 260mm rotation direction right FIR		
spare parts for	500030		
	GEV No.	510510	Ref. No. 34225
	pump cover pump type 2212/2228/2229/2211		
	GEV No.	510690	Ref. No. —
	mechanical shaft seal for shaft ø 8mm ED ø 24mm mounting ø 24/26mm		
	GEV No.	521202	Ref. No. —
	impellor ø 72mm H 17mm thread M5L		
	GEV No.	521703	Ref. No. 34224
	pump cover gasket EPDM thickness 2.5mm ID ø 75mm Qty 1 pcs		

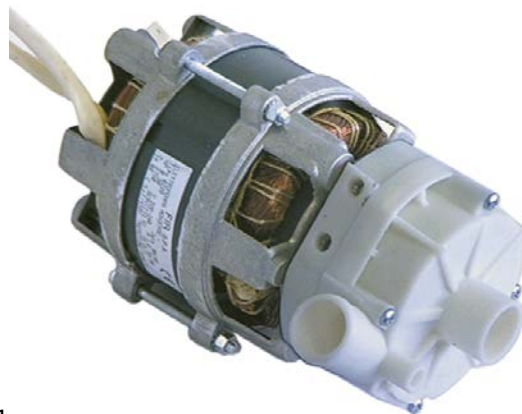

1



GEV No.	500019	Ref. No.	34194
description	pump inlet ø 28mm outlet ø 26mm type B229.1405 230V 50Hz 1 phase 0.22kW 0.3HP L 200mm rotation direction right capacitor 5µF FIR		
For models:	C35, C43, C43D, C48, C48D, CDN3, CDN4, CR43, CR43D, CR48, CR48D, SP35, SP35D, SP40, SP40D, SPB35, SPR36, SPR36D, SPR41, SPR41D		
spare parts for	500019		
	GEV No.	365017	Ref. No. 32712 33543
	operating capacitor capacity 5µF 450V tolerance 5% 50/60Hz ambient temperature max. -25 to +85°C ø 28mm L 54mm M8 plastic connection male faston 6.3mm 16.10.08 protection		
	GEV No.	510510	Ref. No. 34225
	pump cover pump type 2212/2228/2229/2211		



Table continues overleaf



Зип Общепит

vsezip.ru

+7(812)987-08-81

spare parts for 500019			
	GEV No.	510532	Ref. No. 34223
impellor ø 72mm H 22mm shaft ø 11mm shaft length 32mm blades 3			
	GEV No.	510695	Ref. No. 34226
mechanical shaft seal height counter ring 5.5mm ID ø 11mm			
	GEV No.	521703	Ref. No. 34224
pump cover gasket EPDM thickness 2.5mm ID ø 75mm Qty 1 pcs			



1

GEV No.	499170	Ref. No.	32027
description	pump inlet ø 45mm outlet ø 1" IT type 4243.1400 230V 1 phase 0.55kW 0.75HP L 310mm rotation direction right capacitor 12.5µF FIR		
For models:	APS43, APS48, APS48B, APS53, APS60, APSE48, APSE53, APSE60, BPN48, BPS52, FW35, FW40, FW40B, FW45, FW50		





1

GEV No.	500558	Ref. No.	33542 8455
description	pump inlet ø 33mm outlet ø 30/28mm type B266H1500 230V 50Hz 1 phase 0.22kW 0.3HP L 195mm rotation direction right capacitor 5µF FIR		
For models:	C43ALTA, C48DDL, C48DL, DP35, DP35D, DP40, DP40D, GS-X1011, GS-X1011-WEH, GS-X1021, GS-X1021-WEH, SP35ALTA, SP40DDL, SP40DL, STS43, STS43D, STS48, STS48D		

spare parts for 500558			
	GEV No.	365017	Ref. No. 32712 33543
operating capacitor capacity 5µF 450V tolerance 5% 50/60Hz ambient temperature max. -25 to +85°C ø 28mm L 54mm M8 plastic connection male faston 6.3mm 16.10.08 protection			

	GEV No.	510693	Ref. No. 26314 33840 34182 H630501 H630523
mechanical shaft seal for shaft ø 12mm slide ring ext. ø 24mm slide ring H 15.5mm slide ring int. ø 11mm counter ring mounting ø 24mm height counter ring 8mm counter ring int. ø 13.5mm			

	GEV No.	521545	Ref. No. 34341
pump cover FIR type B226H inlet ø 33mm outlet ø 30/28mm			

	GEV No.	521565	Ref. No. 34340
pump cover gasket pump type B226H			

	GEV No.	521566	Ref. No. 34339
impellor ø 80mm H 15mm M7L pump type B226H			



1

GEV No.	500463	Ref. No.	31260
description	pump inlet ø 45mm outlet ø 30mm type 2253 230V 50Hz 1 phase 0.24kW 0.33HP L 160mm rotation direction right FIR		
For models:	INDY48F, TS48, UNI48C, UNI48CD		

spare parts for 500463			
	GEV No.	521148	Ref. No. 31406
pump cover pump type Fir 2253(500.463)			



Зип Общепит

vsezip.ru

+7(812)987-08-81

→ electric components



1

GEV No.	500125	Ref. No.	31823
description	pump inlet ø 45mm outlet ø 30mm type 2253 230V 50Hz 1 phase 0.24kW 0.33HP L 175mm rotation direction right capacitor 10µF FIR inlet ø 45mm outlet ø 30mm		



1

GEV No.	500025	Ref. No.	25313 28850
description	pump inlet ø 45mm outlet ø 40mm type 3981.1400 230V 50Hz 1 phase 0.24kW 0.33HP rotation direction right FIR		
For models:	CM48, CMD48, NK48, NKD48, T3-80, T4-80, UNI48R, UNI48RD		







1

GEV No.	499123	Ref. No.	34170
description	pump inlet ø 45mm outlet ø 40mm type 4296.2350 230V 50Hz 1 phase 0.75kW L 250mm rotation direction right capacitor 16µF FIR		

For models: 60BT, 60BT-3, 60EBT, C53DE, C53E, C60, C60D, C60DE, C60E, DP45DE, DP45E, DP50, DP50D, DP50DE, DP50E, DP50EBT, RSP50, RSP50A, SD5BT, SP45DE, SP45E, SP50, SP50-400V, SP50-440V, SP50D, SP50DE, SP50E, ST53DE, ST53E, ST60DE, ST60E, ST60EBT, STS60, STS60D, TN-TDN5, TN-TDN6, VS-X313, VS-X313-LP-DOS, VS-X515, VS-X515-LP-DOS

spare parts for 499123

GEV No.	365021	Ref. No.	34173
	operating capacitor capacity 16µF 425V tolerance 5% 50/60Hz ambient temperature max. -25 to +85°C ø 35mm L 73mm single M8 plastic connection male faston 6.3mm 416.10.99 protection		
GEV No.	510608	Ref. No.	—
	impellor ø 93mm H 32mm shaft intake ø 9/8mm blades 6 inner height 11mm		
GEV No.	510692	Ref. No.	630510 H630510
	mechanical shaft seal for shaft ø 11mm slide ringext. ø 24mm slide ring H 13mm counter ring mounting ø 26mm height counter ring 8mm counter ring int. ø 14mm		
GEV No.	521539	Ref. No.	26181 26181 + 15211
	pump cover FIR inlet ø 45mm outlet ø 40mm auxiliary pressure connection 10mm supporting pressure open turn direction right ø 160mm ID ø 125mm inner height 25mm		
GEV No.	521702	Ref. No.	—
	pump cover gasket thickness 3.5x4.5mm Qty 1 pcs		

Зип-Общепит

vsezip.ru

+7(812)987-08-81



GEV No.	499285	Ref. No.	32244
description	pump inlet ø 45mm outlet ø 43mm type 4242.1400 230V 50Hz 1 phase 0.37kW 0.5HP L 270mm rotation direction right FIR		
For models:	APS43, APS48, APS48B, APS53, APS60, APSE43, BPS43, FW35, FW40, FW40B, FW45, FW50		

spare parts for	500018		
GEV No.	524416	Ref. No.	H630411
description	pump cover gasket thickness 4x4mm Qty 1 pcs		





GEV No.	499152	Ref. No.	25332
description	pump inlet ø 63mm outlet ø 53mm type 1205.2502 230/400V 50Hz 3 phase 2kW 2.7HP L 328mm rotation direction left auxiliary pressure connection 10mm FIR		
For models:	ED700		



GEV No.	500018	Ref. No.	H100361
description	pump inlet ø 63mm outlet ø 53mm type 1204.2528 230/400V 50Hz 3 phase 1.5kW 2HP L 328mm rotation direction left FIR		
For models:	EDT100, EDT140, EDT170, EDT200, EDT230, EDT85, TR100, TR140, TR170, TR200, TR230, TR90, TR-E200, TR-E230		

spare parts for	500018		
------------------------	--------	--	--

	GEV No.	510523	Ref. No.	—
		fan wheel ø 142mm shaft intake ø 15mm blades 12		

	GEV No.	510531	Ref. No.	630114 H630114
		pump cover FIR inlet ø 63mm outlet ø 53mm auxiliary pressure connection M16x1.5mm supporting pressure open turn direction left ø 185mm ID ø 150mm inner height 37mm		

	GEV No.	510604	Ref. No.	631618 H631618
		impellor ø 118mm H 34mm M8R rotation direction left		

	GEV No.	510693	Ref. No.	26314 33840 34182 H630501 H630523
		mechanical shaft seal for shaft ø 12mm slide ring ext. ø 24mm slide ring H 15.5mm slide ring int. ø 11mm counter ring mounting ø 24mm height counter ring 8mm counter ring int. ø 13.5mm		

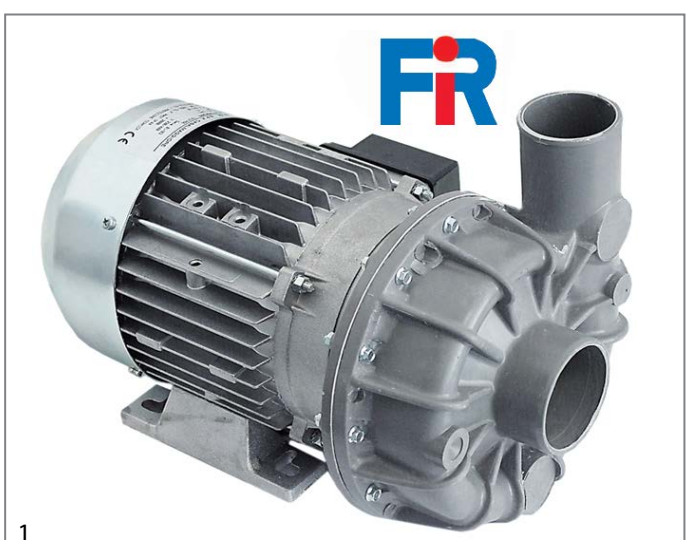

GEV No.	500111	Ref. No.	25326
description	pump inlet ø 63mm outlet ø 53mm type 1241.2500 230/400V 50Hz 3 phase 1.1kW 1.5HP L 330mm rotation direction left FIR		
For models:	CA120, CA90, CAP10, CAP10BT, CAP10DE, ED650E, ED650S, ED650S-90, RCA1200, RCA1200i, SO100, SO100-400V3-50Hz-MARINE		

spare parts for	500111		
------------------------	--------	--	--

	GEV No.	510531	Ref. No.	630114 H630114
		pump cover FIR inlet ø 63mm outlet ø 53mm auxiliary pressure connection M16x1.5mm supporting pressure open turn direction left ø 185mm ID ø 150mm inner height 37mm		

	GEV No.	510612	Ref. No.	26198
		impellor ø 110mm H 34mm M8R		

	GEV No.	510693	Ref. No.	26314 33840 34182 H630501 H630523
		mechanical shaft seal for shaft ø 12mm slide ring ext. ø 24mm slide ring H 15.5mm slide ring int. ø 11mm counter ring mounting ø 24mm height counter ring 8mm counter ring int. ø 13.5mm		

Table continues overleaf



Зип Общепит

vsezip.ru

+7(812)987-08-81

spare parts for 500111			
	GEV No.	524416	Ref. No. H630411
pump cover gasket thickness 4x4mm Qty 1 pcs			







GEV No.	499300	Ref. No.	100886 H100886
description	pump inlet ø 63mm outlet ø 53mm type 5223.4050 230/400V 50Hz 3 phase 1.1kW L 316mm rotation direction left FIR		
For models:	TR-E90		



GEV No.	499113	Ref. No.	34432
description	pump inlet ø 63mm outlet ø 53mm type 5234.4050 230/400V 50Hz 3 phase 1.62kW 2.2HP L 340mm rotation direction left FIR		



GEV No.	499301	Ref. No.	35841
description	pump inlet ø 28mm outlet ø 26mm type ZF131DX 230V 50Hz 1 phase 0.2kW L 195mm rotation direction left capacitor 6.3µF LGB		
For models:	60BT, 60BT-3, 60EBT, C68EBT, C6EBT, C81EBT, C90EBT, C90EBT2, CAP10BT, CAP12EBT, DP50EBT, EDI4, LO56, SD5BT, ST48EBT, ST60EBT		

spare parts for 499301			
	GEV No.	365012	Ref. No. —
operating capacitor capacity 6.3µF 450V tolerance 5% 50Hz ambient temperature max. -25 to +85°C ø 30mm L 61mm M8 plastic connection male faston 6.3mm protection			
	GEV No.	510703	Ref. No. 38795
mechanical shaft seal for shaft ø 13mm slide ring H 13mm height counter ring 5.5mm ED ø 26mm			
	GEV No.	521084	Ref. No. —
pump cover LGB inlet ø 28mm outlet ø 25mm auxiliary pressure connection 13mm pump type ZF131DX ID ø 78mm			
	GEV No.	521228	Ref. No. —
impellor ø 72mm H 17mm rotation direction left thread M7R shaft ø 13mm shaft length 12mm blades 3			
	GEV No.	528800	Ref. No. 33183 34224
O-ring EPDM thickness 2.62mm ID ø 75.87mm Qty 1 pcs			

electric components





Зип Общепит

vsezip.ru

+7(812)987-08-81







1

GEV No.	500511	Ref. No.	35143
description	pump inlet ø 30mm outlet ø 29mm type ZF140SX 230V 50Hz 1 phase 0.36kW 0.5HP L 190mm rotation direction right LGB		
For models:	C35E, C43-2, C43DE, C43E, C46DE, C46E, C48-2, C48D-2, C48E, DP35-2, DP35D-2, DP40-2, DP40D-2, DP40D-rib2, DP40-rib2, GS-X1011-2, GS-X1011-WEH-2, GS-X1021-2, GS-X1021-2rib, GS-X1021-WEH-2, GS-X1021-WEH-2rib, RSP40, RSP40A, SP35-2, SP35DE, SP35E, SP40-2, SP40D-2, SP40DE, SP40E, SPB35E, ST43DE, ST43E, ST48DE, ST48E, ST48EBT, STS43-2, STS43D-2, STS48-2, STS48D-2, STS48D-rib2, STS48-rib2, TDN4-2rib		
spare parts for	500511		
	GEV No.	365017	Ref. No. 32712 33543
	operating capacitor capacity 5µF 450V tolerance 5% 50/60Hz ambient temperature max. -25 to +85°C ø 28mm L 54mm M8 plastic connection male faston 6.3mm 16.10.08 protection		
	GEV No.	510703	Ref. No. 38795
	mechanical shaft seal for shaft ø 13mm slide ring H 13mm height counter ring 5.5mm ED ø 26mm		
	GEV No.	521230	Ref. No. 35495
	impellor ø 86mm H 16mm M7L		
	GEV No.	521526	Ref. No. 35496
	pump cover LGB inlet ø 30mm outlet ø 30mm auxiliary pressure connection 12mm supporting pressure open turn direction right ø 117mm ID ø 95mm inner height 19mm		



1

GEV No.	500538	Ref. No.	25311 31654
description	pump inlet ø 30mm outlet ø 30mm type ZF150SX 230V 50Hz 1 phase 0.2kW 0.25HP L 170mm rotation direction right capacitor 10µF LGB		
For models:	CM43, CMD43, E36, E40, E40-2F, E43, INDY43F, NK43, NKD43, TS43, UNI43C, UNI43R, UNI43RD, UNI48R, UNI48RD		
spare parts for	500538		
	GEV No.	365015	Ref. No. —
	operating capacitor capacity 10µF 400V tolerance 5%Hz ambient temperature max. -25 to +85°C ø 35.5mm L 59mm M8 plastic connection male faston 6.3mm protection		
	GEV No.	510703	Ref. No. 38795
	mechanical shaft seal for shaft ø 13mm slide ring H 13mm height counter ring 5.5mm ED ø 26mm		
	GEV No.	521527	Ref. No. —
	pump cover LGB inlet ø 30mm outlet ø 30mm		
	GEV No.	521701	Ref. No. —
	pump cover gasket		
	GEV No.	521707	Ref. No. 26229
	pump cover gasket		



1

GEV No.	499084	Ref. No.	34170
description	pump inlet ø 44mm outlet ø 39mm type ZF340VSX 220-240V 50Hz 1 phase 0.7kW L 245mm rotation direction right capacitor 16µF LGB HOONVED		

Зип Общепит

vsezip.ru

+7(812)987-08-81

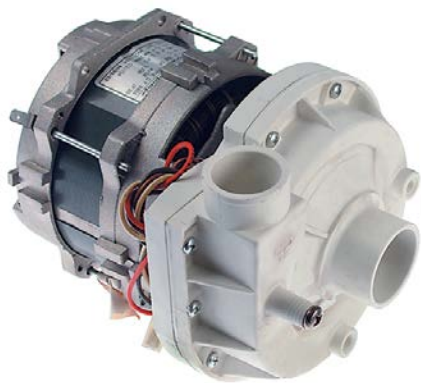

1

GEV No.	500157	Ref. No.	31154
description	pump inlet ø 45mm outlet ø 39mm type ZF320SX 230V 50Hz 1 phase 0.75kW 1HP L 200mm rotation direction right capacitor 12µF LGB		
spare parts for	500157		
	GEV No.	510552	Ref. No. 26224 630410 H630410
	pump cover gasket pump type 1292-2/3942/3981/3911/3983		
	GEV No.	510702	Ref. No. 26194 31575 33181
	mechanical shaft seal height counter ring 5.5mm ID ø 12mm		
	GEV No.	521539	Ref. No. 26181 26181 + 15211
	pump cover FIR inlet ø 45mm outlet ø 40mm auxiliary pressure connection 10mm supporting pressure open turn direction right ø 160mm ID ø 125mm inner high 25mm		

spare parts for	500120		
GEV No.	521714	Ref. No.	33853
	pump cover gasket thickness 4x4mm Qty 1 pcs		



1

GEV No.	500919	Ref. No.	28851
description	pump inlet ø 45mm outlet ø 40mm type ZF320SX 230V 50Hz 1 phase 0.55kW 0.75HP L 200mm rotation direction right capacitor 12µF LGB		
For models:	CM52, CM60, CMD52, CMD60, E50, NK52, NK60, NKD52, NKD60, T5-80, UNI53R, UNI53RD		



1

GEV No.	500120	Ref. No.	31898
description	pump inlet ø 45mm outlet ø 40mm type ZF320SX 230V 50Hz 1 phase 0.55kW 0.75HP L 200mm rotation direction right capacitor 12.5µF LGB		
For models:	INDY53F, UNI53C, UNI60C		
spare parts for	500120		
	GEV No.	365014	Ref. No. 25555
	operating capacitor capacity 12.5µF 450V tolerance 5%Hz ambient temperature max. -25 to +85°C ø 35mm L 70mm M8 plastic connection male faston 6.3mm 45S.C3DS.12.5 protection		
	GEV No.	510702	Ref. No. 26194 31575 33181
	mechanical shaft seal height counter ring 5.5mm ID ø 12mm		
	GEV No.	521300	Ref. No. 33843
	impellor ø 94mm H 27mm pump type ZF320SX thread M8L		
	GEV No.	521542	Ref. No. —
	pump cover LGB inlet ø 45mm outlet ø 40mm auxiliary pressure connection 13mm supporting pressure open ø 150mm ID ø 120mm inner high 25mm		



1

GEV No.	500121	Ref. No.	31682
description	pump inlet ø 45mm outlet ø 40mm type ZF320SX 230V 50Hz 1 phase 0.55kW 0.75HP L 220mm rotation direction right capacitor 12.5µF LGB		
For models:	C53, C53D, C53DE, C53E, C6, C60, C60DE, C60E, C6D, C6DE, C6E, C6EBT, DP45, DP45D, DP45DE, DP45E, DP50, DP50D, DP50DE, DP50E, DP50EBT, SP45, SP45D, SP45DE, SP45E, SP5, SP50DE, SP50E, SP5D, SP5DE, SP5E, ST53DE, ST53E, ST60DE, ST60E, ST60EBT, ST553, ST553D, ST560, ST560D, TN-TDN5, TN-TDN6		
spare parts for	500121		
	GEV No.	365014	Ref. No. 25555
	operating capacitor capacity 12.5µF 450V tolerance 5%Hz ambient temperature max. -25 to +85°C ø 35mm L 70mm M8 plastic connection male faston 6.3mm 45S.C3DS.12.5 protection		
	GEV No.	510702	Ref. No. 26194 31575 33181
	mechanical shaft seal height counter ring 5.5mm ID ø 12mm		
	GEV No.	521300	Ref. No. 33843
	impellor ø 94mm H 27mm pump type ZF320SX thread M8L		



Table continues overleaf



Зип Общепит





vsezip.ru

+7(812)987-08-81

spare parts for 500121				
	GEV No.	521542	Ref. No.	—
pump cover LGB inlet \varnothing 45mm outlet \varnothing 40mm auxiliary pressure connection 13mm supporting pressure open \varnothing 150mm ID \varnothing 120mm inner height 25mm				
	GEV No.	521714	Ref. No.	33853
pump cover gasket thickness 4x4mm Qty 1 pcs				







1

GEV No.	500122	Ref. No.	29562 34193	
description	pump inlet \varnothing 62mm outlet \varnothing 52mm type AM5225DX 230/400V 50Hz 3 phase 1.2kW 1.6HP L 300mm rotation direction left LGB			
For models:	CA55, CA90, CAP7, ED550, ED650E, ED650E-90, K80F, K80G, RCA1100, SO55, SO55-400V3-50Hz-MARINE			
spare parts for 500122				
	GEV No.	501495	Ref. No.	—
cover plastic for terminal box for pump LGB				
	GEV No.	510551	Ref. No.	26223 27066 33855
pump cover gasket ID \varnothing 158.3mm pump type 1214/1293/1225/2243/1226/1204/3473/1241 thickness 3.53mm EPDM Qty 1 pcs				
	GEV No.	510694	Ref. No.	27067 33839
mechanical shaft seal for shaft \varnothing 13mm height counter ring 8mm ID \varnothing 11.5mm H 16mm mounting \varnothing 24/26mm int. \varnothing 1 14mm				
	GEV No.	521236	Ref. No.	33856
impellor \varnothing 105mm H 32mm M8R				
	GEV No.	521516	Ref. No.	33848 630154
pump cover LGB inlet \varnothing 62mm outlet \varnothing 52mm auxiliary pressure connection 12mm supporting pressure closed turn direction left \varnothing 190mm ID \varnothing 150mm inner height 40mm				



1

GEV No.	500536	Ref. No.	31147	
description	pump inlet \varnothing 62mm outlet \varnothing 52mm type AM5225DX 230V 50Hz 1 phase 0.9kW 1.2HP L 300mm rotation direction left capacitor 20 μ F LGB			
For models:	CA90, ED650E, ED650S			
spare parts for 500536				
	GEV No.	365019	Ref. No.	—
operating capacitor capacity 20 μ F 400V tolerance 5% 50/60Hz ambient temperature max. -25 to +85°C \varnothing 39.5mm L 70mm M8 plastic connection male faston 6.3mm 16.10.25. protection				
	GEV No.	510551	Ref. No.	26223 27066 33855
pump cover gasket ID \varnothing 158.3mm pump type 1214/1293/1225/2243/1226/1204/3473/1241 thickness 3.53mm EPDM Qty 1 pcs				
	GEV No.	510694	Ref. No.	27067 33839
mechanical shaft seal for shaft \varnothing 13mm height counter ring 8mm ID \varnothing 11.5mm H 16mm mounting \varnothing 24/26mm int. \varnothing 1 14mm				
	GEV No.	521217	Ref. No.	33844
impellor \varnothing 110mm H 32mm thread M8R shaft \varnothing 20mm shaft length 10mm seat \varnothing 8.2mm blades 6 for ZF522DX				
	GEV No.	521516	Ref. No.	33848 630154
pump cover LGB inlet \varnothing 62mm outlet \varnothing 52mm auxiliary pressure connection 12mm supporting pressure closed turn direction left \varnothing 190mm ID \varnothing 150mm inner height 40mm				

Зип Общепит

vsezip.ru

+7(812)987-08-81



GEV No.	500537	Ref. No.	34800
description	pump inlet ø 62mm outlet ø 52mm type ZF522VDX 230V 50Hz 1 phase 0.85kW 1.16HP L 255mm rotation direction left capacitor 16µF auxiliary pressure connection 12mm supporting pressure open LGB		
For models:	CA55, CAP7, CAP7E, ED550, SO55, SO55E		
spare parts for	500537		
	GEV No.	365021	Ref. No. 34173
	operating capacitor capacity 16µF 425V tolerance 5% 50/60Hz ambient temperature max. -25 to +85°C ø 35mm L 73mm single M8 plastic connection male faston 6.3mm 416.10.99 protection		
	GEV No.	510551	Ref. No. 26223 27066 33855
	pump cover gasket ID ø 158.3mm pump type 1214/1293/1225/2243/1226/1204/3473/1241 thickness 3.53mm EPDM Qty 1 pcs		
	GEV No.	510693	Ref. No. 26314 33840 34182 H630501 H630523
	mechanical shaft seal for shaft ø 12mm slide ring ext. ø 24mm slide ring H 15.5mm slide ring int. ø 11mm counter ring mounting ø 24mm height counter ring 8mm counter ring int. ø 13.5mm		
	GEV No.	512420	Ref. No. —
	bracket mounting distance 110mm		
	GEV No.	512421	Ref. No. —
	fan wheel shaft intake ø 11mm ø 110mm H 20mm		
	GEV No.	521058	Ref. No. —
	fanwheel cover suitable for LGB ID ø 138mm ED ø 142mm H 59mm plastic		
	GEV No.	521281	Ref. No. —
	impellor ø 90mm H 30mm thread M8R shaft ø 20mm shaft length 10mm seat ø 8.2mm blades 6		
	GEV No.	521516	Ref. No. 33848 630154
	pump cover LGB inlet ø 62mm outlet ø 52mm auxiliary pressure connection 12mm supporting pressure closed turn direction left ø 190mm ID ø 150mm inner height 40mm		



GEV No.	499141	Ref. No.	34432 36334
description	pump inlet ø 62mm outlet ø 52mm type ZF800DX 230/400V 50Hz 3 phase 1.65kW 2.2HP L 336mm rotation direction left auxiliary pressure connection 12mm supporting pressure closed LGB		
For models:	C90, C90DE, C90DE2, C90E, C90E2, C90EBT, C90EBT2, C98, CAP10, CAP12, CAP12DE, CAP12EBT, EDI4, EDI6, EDI6-2, EDI6BT, HD40ALTABT, HD40BT, HD60BT, LO50, LO50E, LO56, LO62, LO67, LO67-2, RLO200, RLO50, SMW15, SMW15E, SO120, US-X501		
spare parts for	499141		
	GEV No.	510551	Ref. No. 26223 27066 33855
	pump cover gasket ID ø 158.3mm pump type 1214/1293/1225/2243/1226/1204/3473/1241 thickness 3.53mm EPDM Qty 1 pcs		
	GEV No.	510694	Ref. No. 27067 33839
	mechanical shaft seal for shaft ø 13mm height counter ring 8mm ID ø 11.5mm H 16mm mounting ø 24/26mm int. ø 14mm		
	GEV No.	521276	Ref. No. 34484
	impellor ø 120mm H 39mm pump type ZF800DX shaft intake ø 12mm rotation direction left thread M8R pump for ZF800DX blades 6		
	GEV No.	521516	Ref. No. 33848 630154
	pump cover LGB inlet ø 62mm outlet ø 52mm auxiliary pressure connection 12mm supporting pressure closed turn direction left ø 190mm ID ø 150mm inner height 40mm		

booster pumps I



GEV No.	499236	Ref. No.	100789 H100789
description	pump inlet ø 1 1/4" IT outlet ø 1" IT type CEA120/2/A 220-240/380-415V 50Hz 3 phase 0.64kW rotation direction left LOWARA		
For models:	EDI13-2, EDI13ALTA-2, EDI13ALTABT, EDI13BT, EDI6BT, EDI8-2, EDI8BT, HG2LR, HGLR, LO134-2, LO134ALTA-2, LO83-2		



Зип Общепит

vsezip.ru

+7(812)987-08-81



1

GEV No.	500060	Ref. No.	25342 25345
description	pump inlet \varnothing 1" outlet \varnothing 1" type PQM60 230V 50Hz 1 phase 0.37kW PEDRELLLO		
For models:	C90DE, C90DE2, C98, ED700, LO62		
accessories for	500060		
	GEV No.	365015	Ref. No. —
	operating capacitor capacity 10 μ F 400V tolerance 5%Hz ambient temperature max. -25 to +85°C \varnothing 35.5mm L 59mm M8 plastic connection male faston 6.3mm protection		



1

GEV No.	500961	Ref. No.	H100342
description	drain pump inlet \varnothing 30mm outlet \varnothing 23mm 100W 230V 50Hz GRE		
For models:	CAP7, CAP7E, EDI4, LO56, SO55, SO55E		
accessories for	500961		
	GEV No.	524719	Ref. No. —
	formed hose hose ext. \varnothing 40mm hose int. \varnothing 30mm L 65mm warewashing black Qty 1		

drain pumps

GRE



1

GEV No.	500967	Ref. No.	100803 H100803
description	drain pump inlet \varnothing 30mm outlet \varnothing 22mm 100W 230V 50Hz GRE		
spare parts for	500967		
	GEV No.	500307	Ref. No. —
	filter		
	GEV No.	500899	Ref. No. —
	pump cover inlet \varnothing 30mm outlet \varnothing 22mm pump type 500.213		



1

GEV No.	500462	Ref. No.	31623
description	drain pump inlet \varnothing 30mm outlet \varnothing 23mm 100W 230V 50Hz GRE		
For models:	APS43, APS48, APS48B, APS53, APS60, APSE43, APSE48, APSE53, APSE60, BPN48, BPS43, BPS52, FW35, FW40, FW40B, FW45, FW50, VS-X313, VS-X313-LP-DOS, VS-X515, VS-X515-LP-DOS		

HANNING



1

GEV No.	499286	Ref. No.	100893 35093
description	drain pump inlet \varnothing 30mm outlet \varnothing 24mm 220-240V 30W 50Hz HANNING type DPS25-131		
For models:	60BT, 60BT-3, 60EBT, AP43E, AP48E, AP53E, AP60E, APS43, APS48, APS48B, APS53, APS60, C35E, C43DE, C43E, C46DE, C46E, C53DE, C53E, C60DE, C60E, C68DE, C68E, C6DE, C6E, C6EBT, DP45DE, DP45E, DP50DE, DP50E, DP50EBT, FW35, FW35E, FW40, FW40B, FW40E, FW45, FW50, RSP50, RSP50A, SD5BT, SP35DE, SP35E, SP40DE, SP40E, SP45DE, SP45E, SP50DE, SP50E, SP50E-400V3-50Hz-MARINE...(Other models you can see in the webshop)		



booster pumps II

accessories



1			
GEV No.	365017	Ref. No.	32712 33543
description	operating capacitor capacity 5µF 450V tolerance 5% 50/60Hz ambient temperature max. -25 to +85°C ø 28mm L 54mm M8 plastic connection male faston 6.3mm 16.10.08 protection		
For models:	60BT, 60BT-3, 60EBT, AP43E, AP48E, C3, C35, C35E, C4, C43, C43-2, C43ALTA, C43D, C43DE, C43E, C46DE, C46E, C48, C48-2, C48D, C48D-2, C48DDL, C48DL, C48E, C90EBT, C90EBT2, C98, CAP10BT, CAP12EBT, CDN3, CDN4, CR43, CR43D, CR48, CR48D, DP35, DP35-2, DP35D, DP35D-2, DP40, DP40-2, DP40D, DP40D-2, DP40D-rib2, DP40-rib2, EDI13, EDI13-2, EDI13ALTA, EDI13ALTA-2, EDI4...(Other models you can see in the webshop)		

Зип Общепит

vseZEVU
Image not available

+7(812)987-08-81

GEV No.	512067	Ref. No.	32544
description	operating capacitor capacity 40µF 450V		



1			
GEV No.	365017	Ref. No.	32712 33543
description	operating capacitor capacity 5µF 450V tolerance 5% 50/60Hz ambient temperature max. -25 to +85°C ø 28mm L 54mm M8 plastic connection male faston 6.3mm 16.10.08 protection		
For models:	60BT, 60BT-3, 60EBT, AP43E, AP48E, C3, C35, C35E, C4, C43, C43-2, C43ALTA, C43D, C43DE, C43E, C46DE, C46E, C48, C48-2, C48D, C48D-2, C48DDL, C48DL, C48E, C90EBT, C90EBT2, C98, CAP10BT, CAP12EBT, CDN3, CDN4, CR43, CR43D, CR48, CR48D, DP35, DP35-2, DP35D, DP35D-2, DP40, DP40-2, DP40D, DP40D-2, DP40D-rib2, DP40-rib2, EDI13, EDI13-2, EDI13ALTA, EDI13ALTA-2, EDI4...(Other models you can see in the webshop)		

condensators & interference suppression filters

operating capacitors

plastic



1			
GEV No.	365014	Ref. No.	25555
description	operating capacitor capacity 12.5µF 450V tolerance 5%Hz ambient temperature max. -25 to +85°C ø 35mm L 70mm M8 plastic connection male faston 6.3mm 45S.C3D5.12.5 protection		
For models:	AP53E, AP60E, APS43, APS48, APS48B, APS53, APS60, APSE43, APSE48, APSE53, APSE60, BPN48, BPS43, BPS52, C53, C53D, C53DE, C53E, C6, C60, C60DE, C60E, C68DE, C68E, C68EBT, C6D, C6DE, C6E, C6EBT, CM48, CM52, CM60, CMD48, CMD52, CMD60, DP45, DP45D, DP45DE, DP45E, DP50, DP50D, DP50DE, DP50E, E50, ED700-90, FW35, FW40, FW40B, FW45, FW50...(Other models you can see in the webshop)		

filters

interference suppression filters



1			
GEV No.	365046	Ref. No.	631209 H631209
description	interference suppression filter type 10S7E-G1474253105-Q 115/250V 50/60Hz conductor 2 with E connection male faston 6.3mm L 40mm ø 40mm Hmm Wmm M8 plastic Qty 1 pcs		
For models:	60EBT, C35E, C43DE, C43E, C46DE, C46E, C53DE, C53E, C60DE, C60E, C6DE, C6E, C6EBT, CAP10, CAP10BT, CAP10DE, CAP12, CAP12DE, CAP12EBT, CAP15EBT, EDI4, HD130BT, HD40ALTA, HD40BT, HD60BT, HD80BT		



1			
GEV No.	365021	Ref. No.	34173
description	operating capacitor capacity 16µF 425V tolerance 5% 50/60Hz ambient temperature max. -25 to +85°C ø 35mm L 73mm single M8 plastic connection male faston 6.3mm 416.10.99 protection		
For models:	60BT, 60BT-3, 60EBT, C53DE, C53E, C60, C60D, C60DE, C60E, C81, C81E, C81EBT, CA55, CAP7, CAP7E, DP50, DP50D, DP50DE, DP50E, DP50EBT, ED550, RSP50, RSP50A, SD5BT, SO55, SO55-400V3-50Hz-MARINE, SO55-440V3-60Hz-MARINE, SO55E, SP45DE, SP45E, SP50, SP50-400V, SP50-440V, SP50D, SP50DE, SP50E, SP81, SP81E, ST60DE, ST60E, ST60EBT, STS60, STS60D, TN-TDN5, TN-TDN6, VS-X313, VS-X313-LP-DOS, VS-X515, VS-X515-LP-DOS		



1			
GEV No.	365086	Ref. No.	31324
description	interference suppression filter type 10S7E-G1474253105-Q 115/250V 50/60Hz conductor 2 with E connection male faston 6.3mm L 40mm ø 40mm Hmm Wmm M8 plastic Qty 1 pcs		
For models:	60BT, 60BT-3, 60EBT, AP43E, AP48E, AP53E, AP60E, APS43, APS48, APS48B, APS53, APS60, APSE43, APSE48, APSE53, APSE60, C35, C35E, C43, C43-2, C43ALTA, C43D, C43DE, C43E, C46DE, C46E, C48, C48-2, C48D, C48D-2, C48DDL, C48DL, C48E, C53, C53D, C53DE, C53E, C6, C60, C60D, C60DE, C60E, C68DE, C68E, C68EBT, C6D, C6DE, C6E, C6EBT, C81...(Other models you can see in the webshop)		

fuses

fine fuses



GEV No.	358028	Ref. No.	130248 H130248
description	fine fuse size ø10x38mm 20A rated 500V type Gg fast-acting Qty 1 pcs		
For models:	AC101, AC151, AC181, AC201, AC241, AC91, EDT100, EDT140, EDT170, EDT200, EDT230, EDT85, HTP195, HTP205, HTP220, TR100, TR140, TR170, TR200, TR230, TR90, TR-E100, TR-E150, TR-E170, TR-E200, TR-E230		



GEV No.	358032	Ref. No.	28118
description	fine fuse size ø10x38mm 25A rated 500V type Gg fast-acting Qty 1 pcs		
For models:	ED600-95, ED700-90, EDI4, EDI5, EDI6, EDI6-2, EDI6BT, EDI8, EDI8-2, EDI8BT, LO56, LO60, LO61, LO67, LO67-2, LO78, LO83, LO83-2, RLO200, RLO300		



GEV No.	358021	Ref. No.	130260 H130260
description	fine fuse size ø10x38mm 2A rated 500V type gl fast-acting Qty 1 pcs		
For models:	AC101, AC151, AC181, AC201, AC241, AC91, EDT100, EDT140, EDT170, EDT200, EDT230, EDT85, TR100, TR140, TR170, TR200, TR230, TR90, TR-E100, TR-E150, TR-E170, TR-E200, TR-E230		



GEV No.	358023	Ref. No.	28048
description	fine fuse size ø10x38mm 6A rated 500V type Gg fast-acting Qty 1 pcs		
For models:	E40, E43, E50, ED600-95, ED630-90, ED700-90, EDI13, EDI13-2, EDI13ALTA, EDI13ALTA-2, EDI13ALTABT, EDI13BT, EDI4, EDI5, EDI6, EDI6-2, EDI6BT, EDI8, EDI8-2, EDI8BT, LO134, LO134-2, LO134ALTA, LO134ALTA-2, LO56, LO60, LO61, LO67, LO67-2, LO78, LO83, LO83-2, RLO200, RLO300, RLO400		

electric accessories

cables

ribbon cables

group 1



GEV No.	400066	Ref. No.	110501 37790
description	ribbon cable 10-pole L 1000mm plug type FC-10P raster size 2.54mm		
For models:	CAP7E, SO55E		

Зип Общепит

vsezip.ru

+7(812)987-08-81



GEV No.	402927	Ref. No.	110492 110498 36492
description	ribbon cable 10-pole L 500mm plug type FC-10P raster size 2.54mm		
For models:	50E, BT, C43DE, C4E, C4DE, C46E, C53DE, C53E, C60DE, C60E, C68DE, C68E, C68EBT, C6DE, C6E, C6EBT, DP45DE, DP45E, DP50DE, DP50E, DP50EBT, SP35DE, SP35E, SP40DE, SP40E, SP45DE, SP45E, SP50DE, SP50E, SP50E-400V3-50Hz-MARINE, SP50E-440V3-60Hz-MARINE, SP5DE, SP5E, SP68DE, SP68E, ST43DE, ST43E, ST48DE, ST48E, ST48EBT, ST53DE, ST53E, ST60DE, ST60E, ST60EBT		



GEV No.	402992	Ref. No.	H110482
description	ribbon cable 20-pole L 1250mm plug type 2 row coded		
For models:	AP43E, AP48E, AP53E, AP60E, C81E, C90DE, C90DE2, C90E, C90EBT, C90EBT2, CAP10, CAP10BT, CAP12, EDI13-2, EDI13ALTA-2, EDI13ALTABT, EDI13BT, EDI4, EDI6-2, EDI6BT, EDI8-2, EDI8BT, FW35E, FW40E, LO134-2, LO134ALTA-2, LO50E, LO56, LO67-2, LO83-2, SMW15E, SO100, SO100-400V3-50Hz-MARINE, SO100-440V3-60Hz-MARINE, SO120, SP81E		

terminals

connection terminals with screw/faston connections



GEV No.	550534 ¹	Ref. No.	H150226
description	power terminal block 3-pole max. 40A max 450V connection ø6mm ² / F6.3 temp.-resist. 150°C cross section 6mm ² mounting distance 67mm with ground lug		
For models:	C35E, C43DE, C43E, C46DE, C46E, C6DE, C6E, SP35DE, SP35E, SP40DE, SP40E, SP5DE, SP5E, SPB35E		

¹with ground lug

equipment-specific units

for dough mixers

chains

connectors



GEV No.	693276	Ref. No.	H410903
description	connector single DIN/ISO 08 B-1 splitting 1/2" links 1 L 23mm internal width 11.8mm rollerø 4.3mm metal		
For models:	EDT100, EDT140, EDT170, EDT200, EDT230, EDT85, TR100, TR140, TR170, TR200, TR230, TR90, TR-E100, TR-E150, TR-E170, TR-E200, TR-E230		



for espresso machines

brewing units

filter holder gaskets

O-rings



1			
GEV No.	510409	Ref. No.	200815 33402 H200815
description	O-ring EPDM thickness 5.34mm ID ø 56.52mm Qty 1 pcs		
For models:	60BT, 60BT-3, 60EBT, AC101, AC151, AC181, AC201, AC241, AC91, AP53E, AP60E, APS43, APS48, APS53, APS60, C53, C53D, C53DE, C53E, C60, C60D, C60DE, C60E, C68DE, C68E, C68EBT, C6DE, C6E, C6EBT, C81, C81E, C81EBT, C90, C90DE, C90DE2, C90E, C90E2, C90EBT, C90EBT2, C98, CA120, CA55, CA90, CAP10, CAP10BT, CAP10DE, CAP12, CAP12DE, CAP12EBT...(Other models you can see in the webshop)		

for coffee grinders



1			
GEV No.	345019	Ref. No.	H120712
description	rotary switch sets of contacts 2 2 0-1 type CA0120002 380V 12A shaft ø 5x5mm shaft L 23mm shaft square connection screw		
For models:	EDT85, TR100, TR90, TR-E90		

for dishwashers

drain and intake components

HOONVED

drain /intake bodies



1			
GEV No.	510803	Ref. No.	160203 33524
description	connection angle ED ø 35mm ID ø 30mm		
For models:	AC101, AC151, AC181, AC201, AC241, AC91, C81, C81E, C81EBT, C90, C90DE, C90DE2, C90E, C90E2, C90EBT, C90EBT2, C98, CA120, CA55, CA90, CAP10, CAP10BT, CAP10DE, CAP12, CAP12DE, CAP12EBT, CAP15EBT, CAP7, CAP7E, ED550, ED600-95, ED650E, ED650S, ED700-90, EDI13, EDI13-2, EDI13ALTA, EDI13ALTA-2, EDI13ALTABT, EDI13BT, EDI4, EDI5, EDI6, EDI6-2, EDI6BT, EDI8, EDI8-2, EDI8BT, EDT100, EDT140...(Other models you can see in the webshop)		

Зип Общепит

vsezip.ru

+7(812)98779900



GEV No.	517638	Ref. No.	25107
description	connection angle thread 1" ø 27.5mm L 84mm		
For models:	CM43, CM43, CM52, CMD43, CMD48, CMD52, E36, E40, E43, E50, NK43, NK48, NK52, NKD43, NKD48, NKD52, T3-80, T4-80, UNI43R, UNI43RD, UNI48R, UNI48RD, UNI53R, UNI53RD		



1			
GEV No.	517636	Ref. No.	190234 31021
description	drain connection angled thread 1 1/4" ø 30mm L 82mm		
For models:	BPN48, BPS43, BPS52, C35E, C43DE, C43E, C46DE, C46E, SP35DE, SP35E, SP40DE, SP40E, SPB35E, ST43DE, ST43E, ST48DE, ST48E		



1			
GEV No.	512110	Ref. No.	190225 30421
description	drain connection thread 1 1/4" hose ø 30mm		
For models:	60BT, 60BT-3, 60EBT, C3, C35, C35E, C4, C43, C43-2, C43ALTA, C43D, C43DE, C43E, C46DE, C46E, C48, C48-2, C48D, C48D-2, C48DDL, C48DL, C48E, C53, C53D, C53DE, C53E, C6, C60, C60D, C60DE, C60E, C68DE, C68E, C68EBT, C6D, C6DE, C6E, C6EBT, CDN3, CDN4, CR43, CR43D, CR48, CR48D, DP35, DP35-2, DP35D, DP35D-2, DP40, DP40-2...(Other models you can see in the webshop)		

accessories for	512110		
	GEV No.	512111	Ref. No.
			28226



O-ring EPDM thickness 2.62mm ID ø 45.69mm Qty 1 pcs



1			
GEV No.	512348	Ref. No.	25003
description	drain fitting thread 1 1/4" ID ø 35mm		
For models:	CM60, CMD60, M60, NK60, NKD60, T5-80, T6-80		



1			
GEV No.	512345	Ref. No.	25002
description	drain fitting thread 1" ED ø 45mm H 50mm ID ø 25mm		
For models:	CM43, CM48, CM52, CMD43, CMD48, CMD52, E36, E40, E43, E50, NK43, NK48, NK52, NKD43, NKD48, NKD52, T3-80, T4-80, UNI43R, UNI43RD, UNI48R, UNI48RD, UNI53R, UNI53RD		



1

GEV No.	510805	Ref. No.	33525 H160301
description	drain fitting thread 1½" ED ø 68mm ID ø 39mm		
For models:	C81, C81E, C90, C90DE, C90E, C90EBT, C98, CA120, CA55, CA90, CAP7, CAP7E, ED550, ED600-95, ED650E, ED650S, ED700-90, EDI13, EDI13ALTA, EDI5, EDI6, EDI8, EDT100, EDT140, EDT170, EDT200, EDT230, EDT85, LO134, LO134ALTA, LO50, LO50E, LO60, LO61, LO62, LO67, LO78, LO83, RCA1100, RCA1200, RCA1200i, RLO200, RLO300, RLO400, RLO50, SMW15, SMW15E, SO55, SO55-400V3-50Hz-MARINE, SO55-440V3-60Hz-MARINE...(Other models you can see in the webshop)		
accessories for	510805		
	GEV No.	510498	Ref. No. 33527 H180109
	nut thread 1½"		



1

GEV No.	524582	Ref. No.	270409 H270409
description	drain fitting thread 1½" ID ø 35.5mm		
For models:	AC101, AC151, AC181, AC201, AC241, AC91, EDI13-2, EDI13ALTA-2, EDI13ALTABT, EDI13BT, EDI6-2, EDI6BT, EDI8-2, EDI8BT, EDT100, EDT140, EDT170, EDT200, EDT230, EDT85, HD130BT, HD60BT, HD80BT, LO134-2, LO134ALTA-2, LO67-2, LO83-2, TR100, TR140, TR170, TR200, TR230, TR90, TR-E100, TR-E150, TR-E170, TR-E200, TR-E230		
accessories for	524582		
	GEV No.	510876	Ref. No. 33530 H200412
	flat gasket rubber ED ø 45mm ID ø 33mm thickness 3mm Qty 1 pcs		
	GEV No.	511298	Ref. No. H160201
	hose connector hose ø 35mm		
	GEV No.	511309	Ref. No. H270104
	nut thread 1½" ø 66mm H 9mm WS 51 brass Qty 1 pcs		
	GEV No.	516254	Ref. No. 33529 H200410
	flat gasket rubber ED ø 66mm ID ø 46mm thickness 2.1mm Qty 1 pcs		



1

GEV No.	512125	Ref. No.	25138
description	drain fitting thread 1½" ID ø 39mm		
For models:	ED600-95, ED630-90, ED650E, ED650E-90, ED650S, ED650S-90, ED700, ED700-90, ED900, ED900-90, EDI5, K80F, K80G, LO122, LO60, LO61, LO78		

Зип Общепит
vsezip.ru
7(812)987-08-81

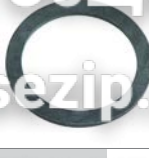

1

GEV No.	512150	Ref. No.	26637
description	flat gasket rubber D1 ø 35mm, D2 ø 42mm thickness 2mm Qty 1 pcs		
For models:	60BT, 60BT-3, 60EBT, C35, C43, C43D, C48, C48D, C53DE, C53E, C6, C60, C60D, C60DE, C60E, C68DE, C68E, C68EBT, C6D, C6DE, C6E, C6EBT, CM60, CMD60, CR43, CR43D, CR48, CR48D, DP45DE, DP45E, DP50, DP50D, DP50D-115V, DP50DE, DP50E, DP50EBT, NK60, NKD60, RSP50, RSP50A, SD5BT, SP35, SP35D, SP40, SP40D, SP45DE, SP45E, SP5, SP50, SP50-400V...(Other models you can see in the webshop)		



1

GEV No.	512346	Ref. No.	25261
description	flat gasket rubber ED ø 44mm ID ø 32mm thickness 2.5mm Qty 1 pcs		
For models:	CM43, CM48, CM52, CM60, CMD43, CMD48, CMD52, CMD60, E36, E40, E43, E50, ED600-95, ED630-90, ED650E, ED650E-90, ED650S, ED650S-90, ED700, ED700-90, ED900, ED900-90, EDI5, K80F, K80G, LO122, LO60, LO61, LO78, M60, NK43, NK48, NK52, NK60, NKD43, NKD48, NKD52, NKD60, T3-80, T4-80, T5-80, T6-80, UNI43R, UNI43RD, UNI48R, UNI48RD, UNI53R, UNI53RD		



1

GEV No.	510876	Ref. No.	33530 H200412
description	flat gasket rubber ED ø 45mm ID ø 33mm thickness 3mm Qty 1 pcs		
For models:	C81, C81E, C81EBT, C90, C90DE, C90DE2, C90E, C90E2, C90EBT, C90EBT2, C98, CA120, CA55, CA90, CAP10, CAP10BT, CAP10DE, CAP12, CAP12DE, CAP12EBT, CAP7, CAP7E, ED550, ED600-95, ED650E, ED650S, ED700-90, EDI13, EDI13-2, EDI13ALTA, EDI13ALTA-2, EDI13ALTABT, EDI13BT, EDI4, EDI5, EDI6, EDI6-2, EDI6BT, EDI8, EDI8-2, EDI8BT, EDT100, EDT140, EDT170, EDT200, EDT230, EDT85, HD130BT, HD40ALTABT, HD40BT...(Other models you can see in the webshop)		



1

GEV No.	512140	Ref. No.	31423
description	flat gasket rubber ED ø 65mm ID ø 51mm thickness 3mm Qty 1 pcs		
For models:	60BT, 60BT-3, APS60, C35, C43, C43ALTA, C43D, C48, C48D, C48DDL, C48DL, C53, C53D, C6, C60, C60D, C6D, CDN3, CDN4, CM48, CM52, CMD43, CMD52, CR43, CR43D, CR48, CR48D, DP35, DP35D, DP40, DP40D, DP45, DP45D, DP50, DP50D, DP50D-115V, FW50, GS-X1011, GS-X1011-WEH, GS-X1021, GS-X1021-WEH, RSP50, RSP50A, SD5BT, SP35, SP35ALTA, SP35D, SP40, SP40D, SP40DDL...(Other models you can see in the webshop)		

GEV No.	516254	Ref. No.	33529 H200410
description	flat gasket rubber ED ø 66mm ID ø 46mm thickness 2mm Qty 1 pcs		
For models:	60BT-3, C81, C81E, C90, C90DE, C90E, C90EBT, C98, CA120, CA55, CA90, CAP7, CAP7E, ED550, ED600-95, ED650E, ED650S, ED700-90, EDI13, EDI13-2, EDI13ALTA, EDI13ALTA-2, EDI13ALTABT, EDI13BT, EDI5, EDI6, EDI6-2, EDI6BT, EDI8, EDI8-2, EDI8BT, EDT100, EDT140, EDT170, EDT200, EDT230, EDT85, LO134, LO134-2, LO134ALTA, LO134ALTA-2, LO50, LO50E, LO60, LO61, LO62, LO67, LO67-2, LO78, LO83...(Other models you can see in the webshop)		



GEV No.	510875	Ref. No.	26289
description	flat gasket rubber ED ø 68mm ID ø 48mm thickness 2mm Qty 1 pcs		
For models:	ED600-95, ED630-90, ED650E, ED650E-90, ED650S, ED650S-90, ED700, ED700-90, ED900, ED900-90, EDI5, K80F, K80G, LO122, LO60, LO61, LO78		



GEV No.	510832	Ref. No.	H200906
description	flat gasket rubber ED ø 92mm ID ø 66mm thickness 2mm Qty 1 pcs equiv. no. 200906/33456		
For models:	C81, C90, C90EBT, C98, CA120, CA55, CA90, CAP7, CAP7E, ED550, ED650E, ED650S, EDI13-2, EDI13ALTA-2, EDI6-2, EDI6BT, EDI8-2, EDT100, EDT140, EDT170, EDT200, EDT230, EDT85, LO134-2, LO134ALTA-2, LO50, LO62, LO67-2, LO83-2, RCA1100, RCA1200, RCA1200i, RLO50, SMW15, SO55, SO55E, SP81, TR100, TR140, TR170, TR200, TR230, TR90, TR-E100, TR-E150, TR-E170, TR-E200, TR-E230, TR-E90, US-X501		





GEV No.	512148	Ref. No.	32717
description	gasket		
For models:	C60, C60D, DP50, DP50D, SP50, SP50-400V, SP50-440V, SP50D, STS60, STS60D, VS-X313, VS-X313-LP-DOS, VS-X515, VS-X515-LP-DOS		



GEV No.	510807	Ref. No.	H160202
description	hose connector hose ø 30mm		
For models:	CAP10BT, EDI13, EDI13-2, EDI13ALTA, EDI13ALTA-2, EDI4, EDI6, EDI6-2, EDI8, EDI8-2, LO134, LO134-2, LO134ALTA, LO134ALTA-2, LO56, LO67, LO67-2, LO83, LO83-2, RLO200, RLO300, RLO400		



GEV No.	511298	Ref. No.	H160201
description	hose connector hose ø 35mm		
For models:	EDT100, EDT140, EDT170, EDT200, EDT230, EDT85, TR100, TR140, TR170, TR200, TR230, TR90, TR-E100, TR-E150, TR-E170, TR-E200, TR-E230, TR-E90		
accessories for	511298		
	GEV No.	510356	Ref. No.
			180102 33526 H180102
	nut thread 1½"		
	GEV No.	510876	Ref. No.
			33530 H200412
	flat gasket rubber ED ø 45mm ID ø 33mm thickness 3mm Qty 1 pcs		



GEV No.	512139	Ref. No.	25001
description	intake body		
For models:	C35, C43, C43D, C48, C48D, CDN3, CDN4, CM43, CM48, CM52, CM60, CMD43, CMD48, CMD52, CMD60, CR43, CR43D, CR48, CR48D, E36, E40, E43, E50, M60, NK43, NK48, NK52, NK60, NKD43, NKD48, NKD52, NKD60, SP35, SP35D, SP40, SP40D, SPB35, SPR36, SPR36D, SPR41, SPR41D, T3-80, T4-80, T5-80, T6-80, UNI43R, UNI43RD, UNI48R, UNI48RD, UNI53R...(Other models you can see in the webshop)		



GEV No.	512149	Ref. No.	32716
description	intake body		
For models:	C60, C60D, DP50, DP50D, SP50, SP50-400V, SP50-440V, SP50D, STS60, STS60D, VS-X313, VS-X313-LP-DOS, VS-X515, VS-X515-LP-DOS		



GEV No.	511329	Ref. No.	31621
description	intake body thread 1¼" ID ø 32mm		

Зип Общепит
vsezip.ru
7(812)987-008-81

Зип Общепит

vsezip.ru

7(812)987-08-81



1

GEV No.	512343	Ref. No.	31621
description	intake body thread 1 1/4" ID 32mm		
For models:	60EBT, AP43E, AP48E, AP53E, AP60E, APS43, APS48, APS48B, APS53, APS60, APSE43, APSE48, APSE53, APSE60, BPN48, BPS43, BPS52, C53DE, C53E, C60DE, C60E, C68DE, C68E, C6DE, C6E, C6EBT, DP45DE, DP45E, DP50DE, DP50E, DP50EBT, FW35, FW35E, FW40, FW40B, FW40E, FW45, FW50, SP45DE, SP45E, SP50DE, SP50E, SP50E-400V3-50Hz-MARINE, SP50E-440V3-60Hz-MARINE, SP5DE, SP5E, SP68DE, SP68E, ST43DE, ST43E...(Other models you can see in the webshop)		



1

GEV No.	510815	Ref. No.	H180236
description	intake body thread 2" ID 51mm		
For models:	EDI13-2, EDI13ALTA-2, EDI6-2, EDI6BT, EDI8-2, EDT100, EDT140, EDT170, EDT200, EDT230, EDT85, LO134-2, LO134ALTA-2, LO67-2, LO83-2, TR100, TR140, TR170, TR200, TR230, TR90, TR-E100, TR-E150, TR-E170, TR-E200, TR-E230, TR-E90		



2

GEV No.	512113	Ref. No.	160310 30425
description	intake body thread 1 1/2" ED 50mm		
For models:	60EBT, AP43E, AP48E, AP53E, AP60E, APS43, APS48, APS48B, APS53, APSE43, APSE48, APSE53, BPN48, BPS43, BPS52, C35E, C43-2, C43DE, C43E, C46DE, C46E, C48-2, C48D-2, C48E, C53DE, C53E, C60DE, C60E, C68DE, C68E, C68EBT, C6DE, C6E, C6EBT, DP35-2, DP35D-2, DP40-2, DP40D-2, DP40D-rib2, DP40-rib2, DP45DE, DP45E, DP50DE, DP50E, DP50EBT, E40-2F, FW35, FW35E, FW40, FW40B...(Other models you can see in the webshop)		
accessories for	512113		
	GEV No.	Ref. No.	200842 31948
O-ring EPDM thickness 3mm ID 56mm Qty 1 pcs			



1

GEV No.	519583	Ref. No.	h180248
description	intake/drain body thread 1 1/2" ED 130mm ID 90mm hose 50mm		



1

GEV No.	512127	Ref. No.	25007
description	nut for drain assembly thread 1 1/2" ED 69mm		
For models:	CM43, CM48, CM52, CM60, CMD43, CMD48, CMD52, CMD60, E36, E40, E43, E50, ED600-95, ED630-90, ED650E, ED650E-90, ED650S, ED650S-90, ED700, ED700-90, ED900, ED900-90, EDI5, K80F, K80G, LO122, LO60, LO61, LO78, NK43, NK48, NK52, NK60, NKD43, NKD48, NKD52, NKD60, UNI43R, UNI43RD, UNI48R, UNI48RD, UNI53R, UNI53RD		



1

GEV No.	512153	Ref. No.	32715
description	intake body thread 1 1/2" hose 40mm		
For models:	60BT, 60BT-3, AP560, APSE60, C3, C4, C43ALTA, C48DDL, C48DL, C53, C53D, C6, C60, C60D, C6D, DP35, DP35D, DP40, DP40D, DP45, DP45D, DP50, DP50D, DP50D-115V, FW50, GS-X1011, GS-X1011-WEH, GS-X1021, GS-X1021-WEH, RSP50, RSP50A, SD5BT, SP35ALTA, SP40DDL, SP40DL, SP45, SP45D, SP5, SP50, SP50-400V, SP50-440V, SP50D, SP5D, STS43, STS43D, STS48, STS48D, STS53, STS53D, STS60...(Other models you can see in the webshop)		



1

GEV No.	512347	Ref. No.	25005
description	nut thread 1"		
For models:	CM43, CM48, CM52, CMD43, CMD48, CMD52, E36, E40, E43, E50, NK43, NK48, NK52, NKD43, NKD48, NKD52, T3-80, T4-80, UNI43R, UNI43RD, UNI48R, UNI48RD, UNI53R, UNI53RD		



1

GEV No.	510472	Ref. No.	180235 33451
description	intake body thread 2" ID 50mm		
For models:	C81, C81E, C81EBT, C90, C90DE, C90E, C90EBT, C98, CA120, CA55, CA90, CAP7, CAP7E, ED550, ED650E, ED650S, HG2LR, HGLR, LO50, LO50E, LO62, RCA1100, RCA1200, RCA1200i, RLO50, SMW15, SMW15E, SO55, SO55-400V3-50Hz-MARINE, SO55-440V3-60Hz-MARINE, SO55E, SP81, SP81E, US-X501		





Зип Общепит

vsezip.ru

(812)987-08-81

 <p>1</p>			
GEV No.	510356	Ref. No.	180102 33523 H180102
description	nut thread 1 1/2"		
For models:	AC101, AC151, AC181, AC201, AC241, AC91, C81, C81E, C81EBT, C90, C90DE, C90DE2, C90E, C90E2, C90EBT, C90EBT2, C98, CA120, CA55, CA90, CAP10, CAP10BT, CAP10DE, CAP12, CAP12DE, CAP12EBT, CAP15EBT, CAP7, CAP7E, ED550, ED600-95, ED650E, ED650S, ED700-90, EDI13, EDI13-2, EDI13ALTA, EDI13ALTA-2, EDI13ALTABT, EDI13BT, EDI4, EDI5, EDI6, EDI6-2, EDI6BT, EDI8, EDI8-2, EDI8BT, EDT100, EDT140... (Other models you can see in the webshop)		
accessories for	510356		
 <p>GEV No. 510876 Ref. No. 33530 H200412</p> <p>flat gasket rubber ED ø 45mm ID ø 33mm thickness 3mm Qty 1 pcs</p>			
 <p>GEV No. 511298 Ref. No. H160201</p> <p>hose connector hose ø 35mm</p>			

 <p>1</p>			
GEV No.	511332	Ref. No.	180145
description	nut thread 1 3/4"		
 <p>1</p>			
GEV No.	512146	Ref. No.	25009
description	nut thread 2" ED ø 60mm		
For models:	C60, C60D, CM60, CMD60, DP50, DP50D, NK60, NKD60, SP50, SP50-400V, SP50-440V, SP50D, STS60, STS60D, T5-80, T6-80, VS-X313, VS-X313-LP-DOS, VS-X515, VS-X515-LP-DOS		

 <p>1</p>			
GEV No.	510498	Ref. No.	33527 H180109
description	nut thread 1 1/2"		
For models:	C81, C81E, C90, C90DE, C90E, C90EBT, C98, CA120, CA55, CA90, CAP7, CAP7E, ED550, ED600-95, ED650E, ED650S, ED700-90, EDI13, EDI13ALTA, EDI5, EDI6, EDI8, EDT100, EDT140, EDT170, EDT200, EDT230, EDT85, LO134, LO134ALTA, LO50, LO50E, LO60, LO61, LO62, LO67, LO78, LO83, RCA1100, RCA1200, RCA1200i, RLO200, RLO300, RLO400, RLO50, SMW15, SMW15E, SO55, SO55-400V3-50Hz-MARINE, SO55-440V3-60Hz-MARINE... (Other models you can see in the webshop)		

 <p>1</p>			
GEV No.	510469	Ref. No.	191057 33452
description	opposite support ED ø 130mm H 74mm		
For models:	C81, C81E, C81EBT, C90, C90DE, C90E, C90EBT, C98, CA120, CA55, CA90, CAP7, CAP7E, ED550, ED650E, ED650S, LO50, LO50E, LO62, RCA1100, RCA1200, RCA1200i, RLO50, SMW15, SMW15E, SO55, SO55-400V3-50Hz-MARINE, SO55-440V3-60Hz-MARINE, SO55E, SP81, SP81E, US-X501		

 <p>1</p>			
GEV No.	512115	Ref. No.	25006
description	nut thread 1 1/2" H 10mm		
For models:	60BT, 60BT-3, 60EBT, AP43E, AP48E, AP53E, AP60E, APS43, APS48, APS48B, APS53, APS60, APSE43, APSE48, APSE53, APSE60, BPN48, BPS43, BPS52, C3, C35, C35E, C4, C43, C43-2, C43ALTA, C43D, C43DE, C43E, C46DE, C46E, C48, C48-2, C48D, C48D-2, C48DDL, C48DL, C48E, C53, C53D, C53DE, C53E, C6, C60, C60D, C60DE, C60E, C68DE, C68E, C68EBT... (Other models you can see in the webshop)		

 <p>1</p>			
GEV No.	512111	Ref. No.	28226
description	O-ring EPDM thickness 2.62mm ID ø 45.69mm Qty 1 pcs		
For models:	60BT, 60BT-3, 60EBT, AP43E, AP48E, AP53E, AP60E, APS43, APS48, APS48B, APS53, APS60, APSE43, APSE48, APSE53, APSE60, BPN48, BPS43, BPS52, C3, C35, C35E, C4, C43, C43-2, C43ALTA, C43D, C43DE, C43E, C46DE, C46E, C48, C48-2, C48D, C48D-2, C48DDL, C48DL, C48E, C53, C53D, C53DE, C53E, C6, C60, C60D, C60DE, C60E, C68DE, C68E, C68EBT... (Other models you can see in the webshop)		

 <p>1</p>			
GEV No.	511309	Ref. No.	H270104
description	nut thread 1 1/2" ø 66mm H 9mm WS 51 brass Qty 1 pcs		
For models:	EDI13-2, EDI13ALTA-2, EDI13ALTABT, EDI13BT, EDI6-2, EDI6BT, EDI8-2, EDI8BT, EDT100, EDT140, EDT170, EDT200, EDT230, EDT85, LO134-2, LO134ALTA-2, LO67-2, LO83-2, TR100, TR140, TR170, TR200, TR230, TR90, TR-E100, TR-E150, TR-E170, TR-E200, TR-E230, TR-E90		

 <p>1</p>			
GEV No.	528192	Ref. No.	200842 31948
description	O-ring EPDM thickness 3mm ID ø 56mm Qty 1 pcs		
For models:	60EBT, AP43E, AP48E, AP53E, AP60E, APS43, APS48, APS48B, APS53, APS60, APSE43, APSE48, APSE53, APSE60, BPN48, BPS43, BPS52, C35E, C43-2, C43DE, C43E, C46DE, C46E, C48-2, C48D-2, C48E, C53DE, C53E, C60DE, C60E, C68DE, C68E, C68EBT, C6DE, C6E, C6EBT, DP35-2, DP35D-2, DP40-2, DP40D-2, DP40D-rib2, DP40-rib2, DP45DE, DP45E, DP50DE, DP50E, DP50EBT, FW35, FW35E, FW40... (Other models you can see in the webshop)		



1

GEV No.	691940	Ref. No.	25293
description	plug		
For models:	AP43E, AP48E, APS43, APS48, APS48B, APS53, APS60, APSE43, APSE48, APSE53, APSE60, C3, C35, C4, C43, C43ALTA, C43D, C48, C48D, C48DDL, C48DL, C53, C53D, C60, C60D, C81, C90, CR43, CR43D, CR48, CR48D, DP35, DP35D, DP40, DP40D, DP45, DP45D, DP50, DP50D, E50, FW35, FW35E, FW40, FW40B, FW40E, FW45, FW50, GS-X1011, GS-X1011-WEH, GS-X1021...(Other models you can see in the webshop)		



1

GEV No.	512344	Ref. No.	34790
description	ring thread 1 1/4" ED ø 71mm ID ø 33mm		
For models:	60BT, 60BT-3, C6, C60, C60D, C6D, DP50, DP50D, DP50D-115V, RSP50, RSP50A, SD5BT, SP5, SP50, SP50-400V, SP50-440V, SP50D, SP5D, STS60, STS60D, TN-TDN5, TN-TDN6, VS-X313, VS-X313-LP-DOS, VS-X515, VS-X515-LP-DOS		



1

GEV No.	512143	Ref. No.	33734
description	ring thread 1 1/4" ID ø 33mm		
For models:	C35, C43, C43D, C48, C48D, CDN3, CDN4, CR43, CR43D, CR48, CR48D, SP35, SP35D, SP40, SP40D, SPB35, SPR36, SPR36D, SPR41, SPR41D		



1

GEV No.	512109	Ref. No.	180147 30422 31637
description	screw connection thread 1 1/4"		
For models:	60EBT, AP43E, AP48E, AP53E, AP60E, APS43, APS48, APS48B, APS53, APS60, APSE43, APSE48, APSE53, APSE60, BPN48, BPS43, BPS52, C3, C35E, C4, C43-2, C43ALTA, C43DE, C43E, C46DE, C46E, C48-2, C48D-2, C48DDL, C48DL, C48E, C53, C53D, C53DE, C53E, C60DE, C60E, C68DE, C68E, C68EBT, C6DE, C6E, C6EBT, DP35, DP35-2, DP35D, DP35D-2, DP40, DP40-2, DP40D...(Other models you can see in the webshop)		



1

GEV No.	510499	Ref. No.	33450 H180128
description	union nut thread 2"		
For models:	C81, C81E, C90, C90DE, C90E, C90EBT, C98, CA120, CA55, CA90, CAP7, CAP7E, ED550, ED650E, ED650S, EDI13-2, EDI13ALTA-2, EDI6-2, EDI6BT, EDI8-2, EDT100, EDT140, EDT170, EDT200, EDT230, EDT85, LO134-2, LO134ALTA-2, LO50, LO50E, LO62, LO67-2, LO83-2, RCA1100, RCA1200, RCA1200i, RLO50, SMW15, SMW15E, SO55, SO55-400V3-50Hz-MARINE, SO55-440V3-60Hz-MARINE, SO55E, SP81, SP81E, TR100, TR140, TR170, TR200, TR230...(Other models you can see in the webshop)		

Зип-Общепит

vsezip.ru

+7(812)987 08 01



1

GEV No.	517630	Ref. No.	36166
description	filter for dishwasher H 115mm L 515mm W 263mm SS with hole mounting pos. front		
For models:	EDI13-2, EDI13ALTA-2, EDI13ALTABT, EDI13BT, HD130BT, LO134-2, LO134ALTA-2		



1

GEV No.	517631	Ref. No.	36090
description	filter for dishwasher H 115mm L 515mm W 263mm SS without hole mounting pos. rear		
For models:	EDI13-2, EDI13ALTA-2, EDI13ALTABT, EDI13BT, HD130BT, LO134-2, LO134ALTA-2		



1

GEV No.	519557	Ref. No.	34876
description	filter for dishwasher H 75mm L 525mm W 200mm SS		
For models:	EDI13, EDI13ALTA, EDI6, EDI8, LO134, LO134ALTA, LO67, LO83, RLO400		



1

GEV No.	512353	Ref. No.	25018
description	filter support ø 63mm thread M6		
For models:	CM48, CMD48, NK48, NKD48, UNI48R, UNI48RD		



1

GEV No.	512138	Ref. No.	25019
description	filter support ø 64mm thread M6		
For models:	C35, C43, C43D, C48, C48D, CDN3, CDN4, CM43, CM52, CM60, CMD43, CMD52, CMD60, CR43, CR43D, CR48, CR48D, E36, E40, E43, E50, NK43, NK52, NK60, NKD43, NKD52, NKD60, SP35, SP35D, SP40, SP40D, SPB35, SPR36, SPR36D, SPR41, SPR41D, UNI43R, UNI43RD, UNI53R, UNI53RD		



Зип Общепит
vsezip.ru
+7(812)987-08-81



1

GEV No.	512105	Ref. No.	21451
description	flat filter		
For models:	E40-2F, INDY43F, INDY48F, TS43, TS48, UNI43C, UNI48C, UNI48CD, UNI53C, UNI60C		



1

GEV No.	512336	Ref. No.	34658
description	flat filter L 210mm W 210mm		
For models:	C43-2, C43ALTA, C43DE, C43E, C46DE, C46E, C48-2, C48D-2, C48DDL, C48DL, C48E, C53, C53D, DP35, DP35-2, DP35D, DP35D-2, DP40, DP40-2, DP40D, DP40D-2, DP40D-rib2, DP40-rib2, DP45, DP45D, GS-X1011, GS-X1011-2, GS-X1011-WEH, GS-X1011-WEH-2, GS-X1021, GS-X1021-2, GS-X1021-2rib, GS-X1021-WEH, GS-X1021-WEH-2, GS-X1021-WEH-2rib, RSP40, RSP40A, SP35-2, SP35ALTA, SP35DE, SP35E, SP40-2, SP40D-2, SP40DDL, SP40DE, SP40DL, SP40E, SP45, SP45D, ST43DE...(Other models you can see in the webshop)		



1

GEV No.	512145	Ref. No.	22012/R
description	flat filter		
For models:	AP560, C60, C60D, DP50, DP50D, FW50, SP50, SP50-400V, SP50-440V, SP50D, STS60, STS60D, VS-X313, VS-X313-LP-DOS, VS-X515, VS-X515-LP-DOS		



1

GEV No.	510224	Ref. No.	180831 36266
description	flat filter L 250mm W 265mm		
For models:	60EBT, C53DE, C53E, C60DE, C60E, C68DE, C68E, C68EBT, C6DE, C6E, C6EBT, DP45DE, DP45E, DP50DE, DP50E, DP50EBT, SP45DE, SP45E, SP50DE, SP50E, SP50E-400V3-50Hz-MARINE, SP50E-440V3-60Hz-MARINE, SP5DE, SP5E, SP68DE, SP68E, ST53DE, ST53E, ST60DE, ST60E, ST60EBT		



1

GEV No.	510370	Ref. No.	34420
description	flat filter H 15mm L 265mm W 200mm		
For models:	C90, C90DE, C90E, C90EBT, C98, CA120, ED650S, LO50, LO50E, LO62, RCA1200, RCA1200i, RLO50, SMW15, SMW15E, US-X501		

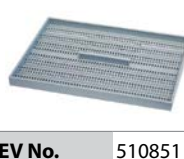

1

GEV No.	510851	Ref. No.	33895
description	flat filter L 265mm W 200mm		
For models:	C81, C81E, C81EBT, CA55, CA90, CAP7, CAP7E, ED550, ED650E, RCA1100, SO55, SO55-400V3-50Hz-MARINE, SO55-440V3-60Hz-MARINE, SO55E, SP81, SP81E		



1

GEV No.	510656	Ref. No.	H332003
description	flat filter H 38mm L 428mm W 278mm		
For models:	EDT100, EDT140, EDT170, EDT200, EDT230, EDT85		



1

GEV No.	512173	Ref. No.	35896
description	flat filter mounting pos. left		
For models:	60BT, 60BT-3, APS60, C6, C60, C60D, C6D, DP50, DP50D, DP50D-115V, FW50, RSP50, RSP50A, SD5BT, SP5, SP50, SP50-400V, SP50-440V, SP50D, SP5D, STS60, STS60D, TN-TDN5, TN-TDN6		



1

GEV No.	512155	Ref. No.	180848 30420
description	flat filter L 205mm W 205mm		
For models:	BPS43, C3, C35E, C4, C53, C53D, DP35, DP35D, DP40, DP40D, DP45, DP45D, E40-2F, INDY43F, INDY48F, SP45, SP45D, STS43, STS43D, STS48, STS48D, STS53, STS53D, TS48, UNI43C, UNI48C, UNI48CD, UNI53C, UNI60C		



1

GEV No.	512172	Ref. No.	35895
description	flat filter mounting pos. right		
For models:	60BT, 60BT-3, APS60, C6, C60, C60D, C6D, DP50, DP50D, DP50D-115V, FW50, RSP50, RSP50A, SD5BT, SP5, SP50, SP50-400V, SP50-440V, SP50D, SP5D, STS60, STS60D, TN-TDN5, TN-TDN6		



1

GEV No.	512333	Ref. No.	21574
description	flat filter L 205mm W 205mm		
For models:	APS43, APS48, APS48B, APS53, APSE43, APSE48, APSE53, BPN48, BPS43, BPS52, FW35, FW40, FW40B, FW45		

Зип Общепит

vsezip.ru

+7(812)987-08-81



			
1			
GEV No.	512151	Ref. No.	32795
description	flat filter ø 192mm		
For models:	60BT, 60BT-3, APS60, APSE60, C6, C60, C60D, C6D, DP50, DP50D, DP50D-115V, FW50, RSP50, RSP50A, SD5BT, SP5, SP50, SP50-400V, SP50-440V, SP50D, SP5D, STS60, STS60D, TN-TDN5, TN-TDN6, VS-X313, VS-X313-LP-DOS, VS-X515, VS-X515-LP-DOS		

			
1			
GEV No.	512354	Ref. No.	25020
description	protector		
For models:	CM52, CM60, CMD52, CMD60, E50, NK52, NK60, NKD52, NKD60, UNI53R, UNI53RD		

			
1			
GEV No.	512352	Ref. No.	16105 u. 25068 16110
description	rectangular filter suction		
For models:	CM52, CMD52, CMD60, E50, M60, NK52, NKD52, NKD60, T5-80, T6-80, UNI53R, UNI53RD		

			
1			
GEV No.	510914	Ref. No.	33459
description	round filters		
For models:	CA120, CA55, CA90, CAP7, CAP7E, ED550, ED650E, ED650S, RCA1100, RCA1200, RCA1200i, SO55, SO55-400V3-50Hz-MARINE, SO55-440V3-60Hz-MARINE, SO55E		

			
1			
GEV No.	512215	Ref. No.	34430
description	round filters		
For models:	C81, C81E, C81EBT, C90, C90DE, C90E, C90EBT, C98, LO50, LO50E, LO62, RLO50, SMW15, SMW15E, SP81, SP81E, US-X501		

			
1			
GEV No.	512147	Ref. No.	32719
description	round filter ø 151 mm H 63 mm		
For models:	60BT, 60BT-3, APS60, APSE60, C6, C60, C60D, C6D, DP50, DP50D, DP50D-115V, FW50, RSP50, RSP50A, SD5BT, SP5, SP50, SP50-400V, SP50-440V, SP50D, SP5D, STS60, STS60D, TN-TDN5, TN-TDN6, VS-X313, VS-X313-LP-DOS, VS-X515, VS-X515-LP-DOS		
accessories for	512147		
	GEV No.	512148	Ref. No. 32717
	gasket		

			
1			
GEV No.	512152	Ref. No.	32796
description	round filters ø 197mm		
For models:	60BT, 60BT-3, APS60, APSE60, C6, C60, C60D, C6D, DP50, DP50D, DP50D-115V, FW50, RSP50, RSP50A, SD5BT, SP5, SP50, SP50-400V, SP50-440V, SP50D, SP5D, STS60, STS60D, TN-TDN5, TN-TDN6, VS-X313, VS-X313-LP-DOS, VS-X515, VS-X515-LP-DOS		

			
1			
GEV No.	511333	Ref. No.	180818 H180818
description	round filters ø 240mm H 95mm		
For models:	CAP10, CAP10BT, CAP10DE, CAP12, CAP12DE, CAP12EBT, CAP7E, HT100, HT150, HTP195, HTP205, HTP220, SO100, SO100-400V3-50Hz-MARINE, SO100-440V3-60Hz-MARINE, SO120		

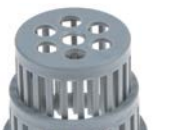
			
1			
GEV No.	519463	Ref. No.	180816 H180816
description	round filters ø 80mm H 72mm		
For models:	AC101, AC151, AC181, AC201, AC241, AC91, EDI13-2, EDI13ALTA-2, EDI13ALTABT, EDI13BT, EDI6-2, EDI6BT, EDI8-2, EDI8BT, EDT100, EDT140, EDT170, EDT200, EDT230, EDT85, HD130BT, HD60BT, HD80BT, LO134-2, LO134ALTA-2, LO67-2, LO83-2, TR100, TR140, TR170, TR200, TR230, TR90, TR-E100, TR-E150, TR-E170, TR-E200, TR-E230, TR-E90		

			
1			
GEV No.	512335 ¹	Ref. No.	31622
description	round filters outflow ø 24mm H 90mm		
For models:	AP43E, AP48E, APS43, APS48, APS48B, APS53, APS60, APSE43, APSE48, APSE53, APSE60, BPN48, BPS43, BPS52, FW35, FW35E, FW40, FW40B, FW40E, FW45, FW50		

¹for drain pump





Zip Общепит
vsezip.ru
7(812)987-08-81

			
1			
GEV No.	512334	Ref. No.	30839
description	round filters safety filter ø 39mm H 12mm		
For models:	APS43, APS48, APS48B, APS53, APS60, APSE43, APSE48, APSE53, APSE60, BPS43, FW35, FW40, FW40B, FW45, FW50		

			
1			
GEV No.	512171	Ref. No.	25021 34557
description	round filters suction ø 70mm H 86mm		
For models:	C35, C43, C43D, C48, C48D, CDN3, CDN4, CM43, CMD43, CR43, CR43D, CR48, CR48D, E36, E40, E43, NK43, NKD43, SP35, SP35D, SP40, SP40D, SPB35, SPR36, SPR36D, SPR41, SPR41D, UNI43R, UNI43RD		

			
1			
GEV No.	512137	Ref. No.	25021
description	round filters suction		

			
1			
GEV No.	512136	Ref. No.	25179 25789
description	wing nuts for filter		
For models:	C35, C43, C43D, C48, C48D, C53, C53D, C60, C60D, CM43, CM48, CM52, CMD43, CMD48, CMD52, CMD60, CR43, CR43D, CR48, CR48D, E36, E40, E43, E50, EDI13, EDI13ALTA, EDI6, EDI8, LO134, LO134ALTA, LO67, LO83, M60, NK43, NK48, NK52, NKD43, NKD48, NKD52, NKD60, RLO200, RLO300, RLO400, SP35, SP35D, SP40, SP40D, SP45, SP45D, SP50...(Other models you can see in the webshop)		

			
1			
GEV No.	512112	Ref. No.	31620
description	round filters suction ø 40mm H 47mm		
For models:	BPN48, BPS43, BPS52, C53, C53D, DP35, DP35D, DP40, DP40D, DP45, DP45D, INDY43F, INDY48F, SP45, SP45D, STS43, STS43D, STS48, STS48D, STS53, STS53D, UNI43C, UNI48C, UNI48CD, UNI53C, UNI60C		

overflow pipes			
			
1			
GEV No.	512028	Ref. No.	29466
description	funnel for overflow pipe suitable for HOONVED		
For models:	ED600-95, ED700-90, ED900-90, EDI5, LO122, LO60, LO61, LO78		

			
1			
GEV No.	512337	Ref. No.	34556
description	round filters suction ø 63mm H 87mm		
For models:	C43-2, C43ALTA, C43DE, C43E, C46DE, C46E, C48-2, C48D-2, C48DDL, C48DL, C48E, C53, C53D, DP35, DP35-2, DP35D, DP35D-2, DP40, DP40-2, DP40D, DP40D-2, DP40D-rib2, DP40-rib2, DP45, DP45D, GS-X1011, GS-X1011-2, GS-X1011-WEH, GS-X1011-WEH-2, GS-X1021, GS-X1021-2, GS-X1021-2rib, GS-X1021-WEH, GS-X1021-WEH-2, GS-X1021-WEH-2rib, RSP40, RSP40A, SP35-2, SP35ALTA, SP35DE, SP35E, SP40-2, SP40D-2, SP40DDL, SP40DE, SP40DL, SP40E, SP45, SP45D, ST43DE...(Other models you can see in the webshop)		

			
1			
GEV No.	510227	Ref. No.	200950 H200950
description	gasket Viton ID ø 27mm ED ø 44mm H 7mm		
For models:	C90DE2, C90E2, C90EBT2, CAP10, CAP10BT, CAP10DE, CAP12, CAP12DE, CAP12EBT, CAP15EBT, CAP7E, EDI4, HD40ALTABT, HD40BT, HT100, HT150, HTP195, HTP205, HTP220, LO56, SO100, SO100-400V3-50Hz-MARINE, SO100-440V3-60Hz-MARINE, SO120		

			
1			
GEV No.	512351	Ref. No.	25022
description	round filters suction ø 70mm H 116mm		
For models:	CM48, CMD48, NK48, NKD48, UNI48R, UNI48RD		



			
1			
GEV No.	511322	Ref. No.	200869 30479
description	O-ring EPDM thickness 3.53mm ID ø 20.22mm Qty 1 pcs		
For models:	60EBT, AP53E, AP60E, C35E, C43-2, C43ALTA, C43DE, C43E, C46DE, C46E, C48-2, C48D-2, C48DDL, C48DL, C48E, C53, C53D, C53DE, C53E, C60DE, C60E, C68DE, C68E, C68EBT, C6DE, C6E, C6EBT, DP35, DP35-2, DP35D, DP35D-2, DP40, DP40-2, DP40D, DP40D-2, DP40D-rib2, DP40-rib2, DP45, DP45D, DP45DE, DP45E, DP50DE, DP50E, DP50EBT, ED700-90, ED900-90, GS-X1011, GS-X1011-2, GS-X1011-WEH, GS-X1011-WEH-2...(Other models you can see in the webshop)		

Зип Общепит
vsezip.ru
7(812)987 08 81

			
1			
GEV No.	512168	Ref. No.	25014
description	overflow pipe L 102mm ø 25mm		
For models:	CM48, CMD48, NK48, NKD48, UNI48R, UNI48RD		

			
1			
GEV No.	512106	Ref. No.	21078 21078/R
description	overflow pipe L 105mm ø 26mm		
For models:	C3, C4, C43ALTA, C48DDL, C48DL, DP35, DP35D, DP40, DP40D, E40-2F, GS-X1011, GS-X1011-WEH, INDY43F, INDY48F, SP35ALTA, SP40DDL, SP40DL, STS43, STS43D, STS48, STS48D, TS43, TS48, UNI43C, UNI48C, UNI48CD		

			
1			
GEV No.	512169	Ref. No.	25015
description	overflow pipe L 113mm ø 25mm		
For models:	CM52, CMD52, E50, NKD52, T3-80, T4-80, UNI53R, UNI53RD		

			
1			
GEV No.	510028	Ref. No.	180730 36395
description	overflow pipe L 120mm ø 26mm		
For models:	60EBT, C53DE, C53E, C60DE, C60E, C68DE, C68E, C68EBT, C6DE, C6E, C6EBT, DP45DE, DP45E, DP50DE, DP50E, DP50EBT, SP45DE, SP45E, SP50DE, SP50E, SP50E-400V3-50Hz-MARINE, SP50E-440V3-60Hz-MARINE, SP5DE, SP5E, SP68DE, SP68E, ST53DE, ST53E, ST60DE, ST60E, ST60EBT		
accessories for	510028		
	GEV No.	511321	Ref. No.
			180725 30424
	GEV No.	511322	Ref. No.
			200869 30479

			
1			
GEV No.	512107	Ref. No.	21286 21286/R
description	overflow pipe L 120mm ø 40mm		
For models:	C43ALTA, C48DDL, C48DL, C53, C53D, DP45, DP45D, SP35ALTA, SP40DDL, SP40DL, SP45, SP45D, STS53, STS53D, TN-TDN5, TN-TDN6, UNI53C, UNI60C		

			
1			
GEV No.	512141	Ref. No.	33735
description	overflow pipe L 125mm ø 36mm		
For models:	C35, C43, C43D, C48, C48D, CDN3, CDN4, CR43, CR43D, CR48, CR48D, SP35, SP35D, SP40, SP40D, SPB35, SPR36, SPR36D, SPR41, SPR41D		

			
1			
GEV No.	510437	Ref. No.	25012 25016
description	overflow pipe L 143mm ø 35mm		
For models:	CM60, CMD60, M60, NK60, NKD60, T5-80, T6-80		

			
1			
GEV No.	512144	Ref. No.	18903
description	overflow pipe L 150mm ø 35mm		
For models:	C60, C60D, DP50, DP50D, SP50, SP50-400V, SP50-440V, SP50D, STS60, STS60D, VS-X313, VS-X313-LP-DOS, VS-X515, VS-X515-LP-DOS		

			
1			
GEV No.	512338	Ref. No.	34485
description	overflow pipe L 160mm ø 35mm		
For models:	60BT, 60BT-3, C6, C60, C60D, C6D, DP50, DP50D, DP50D-115V, RSP50, RSP50A, SD5BT, SP5, SP50, SP50-400V, SP50-440V, SP50D, SP5D, STS60, STS60D, TN-TDN5, TN-TDN6, VS-X313, VS-X313-LP-DOS, VS-X515, VS-X515-LP-DOS		

1

GEV No.	515046	Ref. No.	180708 33528
description	overflow pipe L 190mm ø 37mm		
For models:	C81, C81E, CA120, CA55, CA90, CAP7, CAP7E, ED550, ED650E, ED650S, RCA1100, RCA1200, RCA1200i, SO55, SO55-400V3-50Hz-MARINE, SO55-440V3-60Hz-MARINE, SO55E, SP81, SP81E		



1

GEV No.	517620	Ref. No.	36045
description	overflow pipe L 225mm ø 40mm		
For models:	C98, LO62		



1

GEV No.	512128	Ref. No.	20924
description	overflow pipe L 247mm ø 40mm		
For models:	ED650E, ED650E-90, ED650S-90		



1

GEV No.	510645	Ref. No.	H180729
description	overflow pipe L 283mm ø 42mm		
For models:	CAP10, CAP10BT, CAP12, SO100, SO100-400V3-50Hz-MARINE, SO100-440V3-60Hz-MARINE, SO120		
accessories for	510645		
	GEV No.	510227	Ref. No.
			200950 H200950
gasket Viton ID ø 27mm ED ø 44mm H 7mm			



1

GEV No.	512342	Ref. No.	20923
description	overflow pipe L 290mm ø 40mm		
For models:	ED630-90, ED650S		



1

GEV No.	512095	Ref. No.	21521 21521/R
description	overflow pipe L 360mm ø 170mm tube ø 40mm		
For models:	ED600-90, ED700-90, ED800-90, EDI5, LO122, LO60, LO61, LO78		



1

GEV No.	517619	Ref. No.	34865
description	overflow pipe L 455mm ø 40mm SS ID ø 34mm		
For models:	EDI13, EDI13ALTA, EDI6, EDI8, LO134, LO134ALTA, LO67, LO83, RLO200, RLO300, RLO400		



1

GEV No.	512341	Ref. No.	25013
description	overflow pipe L 81mm ø 25mm		
For models:	CM43, CMD43, E36, E40, E43, NK43, NKD43, UNI43R, UNI43RD		



1

GEV No.	517621	Ref. No.	30423
description	overflow pipe L 97mm ø 56mm tube ø 26mm plastic ID ø 18mm		
For models:	C43ALTA, C48DDL, C48DL, GS-X1011, GS-X1011-WEH, SP35ALTA, SP40DDL, SP40DL		



1

GEV No.	517779	Ref. No.	21452
description	overflow pipe with filter		

containers

salt tanks



1

GEV No.	524177	Ref. No.	25034
description	lid ø 69mm H 20mm for salt tank ID ø 50mm		
For models:	C43D, C43DE, C46DE, C46E, C48D, C48D-2, C48DDL, C48E, C53D, C53DE, C60D, C60DE, C68DE, C68E, C6D, C6DE, C90DE, C90DE2, CAP10DE, CAP12DE, CDN3, CDN4, CMD43, CMD48, CMD52, CMD60, CR43D, CR48D, DP35D, DP35D-2, DP40D, DP40D-2, DP40D-rib2, DP45D, DP45DE, DP50D, DP50D-115V, DP50DE, GS-X1011, GS-X1011-2, GS-X1011-WEH, GS-X1011-WEH-2, GS-X1021, GS-X1021-2, GS-X1021-2rib, GS-X1021-WEH, GS-X1021-WEH-2, GS-X1021-WEH-2rib, NKD43, NKD48...(Other models you can see in the webshop)		
accessories for	524177		
	GEV No.	524148	Ref. No. —
	O-ring EPDM thickness 3.53mm ID ø 40.86mm Qty 1 pcs		



1

GEV No.	510018	Ref. No.	26033
description	nut ø 92mm H 10.5mm for salt tank ID ø 64mm		







Зип Общепит

vsezip.ru

+7(812)987-08-81



1

GEV No.	510929	Ref. No.	20151 25051
description	salt tank ø 120mm H 117mm hose ø 10mm mounting ø 70mm overall height 157mm		
For models:	C43D, C48D, C48D-2, C48DDL, C48E, C53D, C53DE, C60D, C60DE, C68DE, C68E, C6D, C6DE, C90DE, C90DE2, CDN3, CDN4, CMD43, CMD48, CMD52, CMD60, CR43D, CR48D, DP35D, DP35D-2, DP40D, DP40D-2, DP40D-rib2, DP45D, DP45DE, DP50D, DP50D-115V, DP50DE, GS-X1011, GS-X1011-2, GS-X1011-WEH, GS-X1011-WEH-2, GS-X1021, GS-X1021-2, GS-X1021-2rib, GS-X1021-WEH, GS-X1021-WEH-2, GS-X1021-WEH-2rib, NKD43, NKD48, NKD52, NKD60, RSP40A, RSP50A, SP35D...(Other models you can see in the webshop)		
spare parts for	510929		
	GEV No.	506015	Ref. No. 25246
	O-ring EPDM thickness 3.53mm ID ø 39.69mm Qty 1 pcs		
	GEV No.	510018	Ref. No. 26033
	nut ø 92mm H 10.5mm for salt tank ID ø 64mm		
	GEV No.	524177	Ref. No. 25034
	lid ø 69mm H 20mm for salt tank ID ø 50mm		
accessories for	510929		
	GEV No.	510071	Ref. No. —
	flat gasket rubber ED ø 81mm ID ø 68mm thickness 3mm for salt tank Qty 1 pcs		
	GEV No.	510654	Ref. No. —
	gasket H 6mm D1 ø 82mm D2 ø 68mm		
	GEV No.	510883	Ref. No. 25265
	gasket rubber ED ø 86mm ID ø 66mm thickness 2mm for salt tank Qty 1 pcs		

accessories



1

GEV No.	512375	Ref. No.	21679 333013
description	filter for rinse aid container		
For models:	60EBT, AP43E, AP48E, AP53E, AP60E, C35, C35E, C43, C43ALTA, C43D, C43DE, C43E, C46DE, C46E, C48, C48D, C48DDL, C48DL, C53, C53D, C53DE, C53E, C60, C60D, C60DE, C60E, C68DE, C68E, C6DE, C6E, C81E, C81EBT, C90DE2, C90E2, C90EBT, C90EBT2, C98, CAP10, CAP10BT, CAP10DE, CAP12, CAP12DE, CAP12EBT, CAP7, CAP7E, CR43, CR43D, CR48, CR48D, DP35...(Other models you can see in the webshop)		



Зип Общепит

boilers

boilers for dishwashers

vsezip.ru

+7(812)987-08-81

 <p>1</p>			
GEV No.	510883	Ref. No.	25265
description	gasket rubber ED ø 86mm ID ø 66mm thickness 2mm for salt tank Qty 1 pcs		
For models:	C43D, C48D, C48D-2, C48DDL, C48E, C53D, C53DE, C60D, C60DE, C68DE, C68E, C6D, C6DE, C90DE2, CDN3, CDN4, CMD43, CMD48, CMD52, CR43D, CR48D, DP35D, DP35D-2, DP40D, DP40D-2, DP40D-rib2, DP45D, DP50D, DP50D-115V, GS-X1011, GS-X1011-2, GS-X1011-WEH, GS-X1011-WEH-2, GS-X1021, GS-X1021-2, GS-X1021-2rib, GS-X1021-WEH, GS-X1021-WEH-2, GS-X1021-WEH-2rib, NKD43, NKD48, NKD52, RSP40A, RSP50A, SP35D, SP40D, SP40D-2, SP40DDL, SP40E, SP45D...(Other models you can see in the webshop)		

 <p>1</p>			
GEV No.	524178	Ref. No.	25033
description	nut for salt tank		
For models:	C43D, C43DE, C46DE, C46E, C48D, C48D-2, C48DDL, C48E, C53D, C53DE, C60D, C60DE, C68DE, C68E, C6D, C6DE, C90DE, CAP10DE, CAP12DE, CDN3, CDN4, CMD43, CMD48, CMD52, CMD60, CR43D, CR48D, DP35D, DP35D-2, DP40D, DP40D-2, DP40D-rib2, DP45D, DP45DE, DP50D, DP50D-115V, DP50DE, GS-X1011, GS-X1011-2, GS-X1011-WEH, GS-X1011-WEH-2, GS-X1021, GS-X1021-2, GS-X1021-2rib, GS-X1021-WEH, GS-X1021-WEH-2, GS-X1021-WEH-2rib, NKD43, NKD48, NKD52...(Other models you can see in the webshop)		

 <p>1</p>			
GEV No.	510226	Ref. No.	180149 H180149
description	nut ø 65mm for backflow preventer		
For models:	60BT-3, 60EBT, C68EBT, C6EBT, C81EBT, C90EBT, C90EBT2, CAP10BT, CAP12EBT, CAP15EBT, DP50EBT, EDI13ALTABT, EDI13BT, EDI4, EDI6BT, EDI8BT, HD130BT, HD40ALTABT, HD40BT, HD60BT, HD80BT, HT100, HT150, HTP195, HTP205, HTP220, LO56, SD5BT, ST48EBT, ST60EBT		

 <p>1</p>			
GEV No.	512065	Ref. No.	21336
description	boiler		
For models:	UNI43C, UNI48C, UNI48CD, UNI53C, UNI60C		

 <p>1</p>			
GEV No.	512164	Ref. No.	20190
description	boiler		
For models:	CM43, CM48, CMD43, CMD48, E43, NK43, NK48, NKD43, NKD48, T3-80, T4-80, UNI43R, UNI43RD, UNI48R, UNI48RD		

 <p>1</p>			
GEV No.	512165	Ref. No.	21335
description	boiler		
For models:	E40-2F, INDY43F, INDY48F, TS43, TS48, UNI43C, UNI48C, UNI48CD, UNI53C, UNI60C		

 <p>1</p>			
GEV No.	512176	Ref. No.	330377 36713
description	boiler ø 125mm L 360mm flange 3 hole flange inlet ø 46		
For models:	C35E, C43DE, C43E, C46DE, C46E, SP35DE, SP35E, SP40DE, SP40E, ST43DE		

Зип Общепит
vsezip.ru

7(812)987-08-81

			
1			
GEV No.	512181	Ref. No.	18693 35426
description	boiler ø 125mm L 370mm flange 3 hole flange		
For models:	C3, C35, C4, C43, C43-2, C43ALTA, C43D, C48, C48-2, C48D, C48D-2, C48DDL, C48DL, C48E, CDN3, CDN4, CR43, CR43D, CR48, CR48D, DP35, DP35D, DP35D-2, GS-X1011, GS-X1011-2, GS-X1011-WEH, GS-X1011-WEH-2, RSP40, RSP40A, SP35, SP35-2, SP35ALTA, SP35D, SP40, SP40-2, SP40D, SP40D-2, SP40DDL, SP40DL, SP40E, SPB35, SPR36, SPR36D, SPR41, SPR41D, STS43, STS43D, STS43D-2, STS48D-2		

			
1			
GEV No.	512000	Ref. No.	330342 33403
description	boiler ø 150mm L 500mm		
For models:	C81, C81E, C90, C90DE, C90E, CA120, CA55, CA90, CAP10, CAP10DE, CAP12, CAP12DE, CAP7, CAP7E, ED550, ED650E, ED650S, EDI5, LO50, LO50E, LO61, RCA1100, RCA1200, RCA1200i, RLO50, SMW15, SMW15E, SO100, SO100-400V3-50Hz-MARINE, SO100-440V3-60Hz-MARINE, SO120, SO55, SO55-400V3-50Hz-MARINE, SO55-440V3-60Hz-MARINE, SO55E, SP81, SP81E, US-X501		

			
1			
GEV No.	512204	Ref. No.	34216 34647
description	boiler ø 150mm L 340mm		
For models:	DP35, DP35D, DP40, DP40D, DP45, DP45D, DP50, GS-X1021, GS-X1021-WEH, STS43, STS43D, STS48, STS48D, STS53, STS53D, STS60, STS60D		

			
1			
GEV No.	512386	Ref. No.	18212
description	boiler ø 150mm L 540mm		
For models:	ED700-90, ED900-90, LO122, LO78		

			
1			
GEV No.	524450	Ref. No.	34596
description	boiler ø 150mm L 445mm inlet ø 11		
For models:	C53, C53D, C6, C60, C60D, C6D, DP40, DP45, DP45D, DP50, DP50D, DP50D-115V, RSP50, RSP50A, SP45, SP45D, SP5, SP50, SP50-400V, SP50-440V, SP50D, SP5D, STS48, STS53, STS53D, STS60, STS60D, TN-TDN6, VS-X313, VS-X313-LP-DOS, VS-X515, VS-X515-LP-DOS		

			
1			
GEV No.	511000	Ref. No.	330331 330342 330342 old H330342
description	boiler ø 160mm L 500mm capacity 10l flange 3 hole flange inlet ø 12		

			
1			
GEV No.	419063	Ref. No.	330368/1+05990 36558 36558/1 36558+05990
description	boiler ø 150mm L 450mm flange 3 hole flange inlet ø 58		
For models:	AP53E, AP60E, C53DE, C53E, C60DE, C60E, C68DE, C68E, C6DE, C6E, DP45DE, DP45E, DP50DE, DP50E, SP45DE, SP45E, SP50DE, SP50E, SP50E-400V3-50Hz-MARINE, SP50E-440V3-60Hz-MARINE, SP5DE, SP5E, SP68DE, SP68E, ST53DE, ST53E, ST60DE, ST60E		

			
1			
GEV No.	524998	Ref. No.	330320 H330320
description	boiler ø 160mm L 630mm flange 3 hole flange inlet ø 11		
For models:	AC101, AC91, EDT100, EDT85, TR100, TR90, TR-E100, TR-E150, TR-E90		



Зип Общепит

vsezip.ru

+7(812)987-08-81



1

GEV No.	524999	Ref. No.	330339 H330339
description	boiler with insulation ø 200mm L 630mm flange 3 hole flange inlet ø 1/2" IT		



1

GEV No.	524997	Ref. No.	330322 H330322
description	boiler with insulation ø 230mm L 640mm flange 3 hole flange inlet ø 1/2" IT		
For models:	AC201, AC241, EDT200, EDT230, HG2LR, HGLR, HTP195, HTP205, HTP220, TR200, TR230, TR-E200, TR-E230, TR-E90		

gaskets



1

GEV No.	698576	Ref. No.	30007
description	gasket L 31.5mm W 12mm H 4.5mm thickness 4mm		
For models:	APS43, APS48, APS48B, APS53, APS60, APSE43, APSE48, APSE53, APSE60, C35, C43, C43ALTA, C43D, C48, C48D, C48DDL, C48DL, C53, C53D, C60, C60D, CDN3, CDN4, CR43, CR43D, CR48, CR48D, DP35, DP35D, DP40, DP40D, DP45, DP45D, DP50, DP50D, FW35, FW40, FW40B, FW45, FW50, SP35, SP35ALTA, SP35D, SP40, SP40D, SP40DDL, SP40DL, SP45, SP45D, SP50...(Other models you can see in the webshop)		

rotation plates

rotation plates



1

GEV No.	524189	Ref. No.	20071 20071/R 25053
description	rotation plate		
For models:	CDN3, CDN4, CM43, CM48, CM52, CMD43, CMD48, CMD52, CR43, CR43D, CR48, CR48D, E36, E40, E43, NK43, NK48, NKD43, NKD48, SPR36, SPR36D, SPR41, UNI43R, UNI43RD, UNI48R, UNI48RD, UNI53R, UNI53RD		

rotation plate bearings



1

GEV No.	524191	Ref. No.	20140
description	bearing for rotation plate complete		
For models:	CM43, E36, E40, E43, NK43		



1

GEV No.	519420	Ref. No.	15233
description	spindle for rotation plate ø 19.5mm		
For models:	CDN3, CDN4, CM43, CM48, CMD43, CMD48, CR43, CR43D, CR48, CR48D, E36, E40, E43, NK43, NK48, NKD43, NKD48, SPR36, SPR36D, SPR41, SPR41D, UNI43R, UNI43RD, UNI48R, UNI48RD, UNI53R, UNI53RD		

softener cartridges

softening columns



1

GEV No.	530000	Ref. No.	25030
description	softener 4-fold L 380mm W 180mm		



1

GEV No.	530019	Ref. No.	H640212
description	softener double		
For models:	C90DE, C90DE2		



1

GEV No.	530021	Ref. No.	33590
description	softener triple		
For models:	C43D, C48D, C48D-2, C48DDL, C48E, C53D, C60D, C6D, CDN3, CDN4, CR43D, CR48D, DP35D, DP35D-2, DP40D, DP40D-2, DP40D-rib2, DP45D, DP50D, DP50D-115V, GS-X1011, GS-X1011-2, GS-X1011-WEH, GS-X1011-WEH-2, GS-X1021, GS-X1021-2, GS-X1021-2rib, GS-X1021-WEH, GS-X1021-WEH-2, GS-X1021-WEH-2rib, RSP40A, RSP50A, SP35D, SP40D, SP40D-2, SP40DDL, SP40E, SP45D, SP50D, SP5D, SPR36D, SPR41D, STS43D, STS43D-2, STS48D, STS48D-2, STS48D-rib2, STS53D, STS60D, TDN4-2rib...(Other models you can see in the webshop)		

housing and bezels

miscellaneous



1

GEV No.	504350	Ref. No.	602222 H620222
description	equipment foot for dishwasher L 135-230mm		
For models:	EDT100, EDT140, EDT170, EDT200, EDT230, EDT85, TR100, TR140, TR170, TR200, TR230, TR90		

hood mechanics for dishwashers

bolts



1

GEV No.	524378	Ref. No.	H340443
description	pin ED ø 12mm L 61mm thread M8x1.25 for dishwasher		
For models:	EDT100, EDT140, EDT170, EDT200, EDT230, EDT85, TR100, TR140, TR170, TR200, TR230, TR90, TR-E100, TR-E150, TR-E170, TR-E200, TR-E230		

bushes



1

GEV No.	510817	Ref. No.	H160530
description	spacer bush for handle hood mechanics		
For models:	ED650E, ED650S		



1

GEV No.	510848	Ref. No.	H290821
description	spacer bush for switch hood mechanics		
For models:	C98, EDI5, LO61, LO62, RCA1100, RCA1200, RCA1200i		

hood handle supports



1

GEV No.	510350	Ref. No.	33446
description	guide for hood handle		
For models:	CA120, CA55, CA90, CAP10, CAP10BT, CAP12, CAP7, CAP7E, ED550, ED650E, ED650S, RCA1100, RCA1200, RCA1200i, SO100, SO100-400V3-50Hz-MARINE, SO100-440V3-60Hz-MARINE, SO120, SO55, SO55-400V3-50Hz-MARINE, SO55-440V3-60Hz-MARINE, SO55E		

Зип Общепит

vsezip.ru

+7(812)987-9879

GEV No.	510868	Ref. No.	191013 33438
description	handle holder hood mechanics		
For models:	CA120, CA55, CA90, CAP10, CAP10BT, CAP10DE, CAP12, CAP12DE, CAP12EBT, CAP15EBT, CAP7, CAP7E, ED550, ED650E, ED650S, RCA1100, RCA1200, RCA1200i, SO100, SO100-400V3-50Hz-MARINE, SO100-440V3-60Hz-MARINE, SO120, SO55, SO55-400V3-50Hz-MARINE, SO55-440V3-60Hz-MARINE, SO55E		

GEV No.	510869	Ref. No.	191014 33439
description	handle holder hood mechanics		
For models:	CA120, CA55, CA90, CAP10, CAP10BT, CAP10DE, CAP12, CAP12DE, CAP12EBT, CAP15EBT, CAP7, CAP7E, ED550, ED650E, ED650S, RCA1100, RCA1200, RCA1200i, SO100, SO100-400V3-50Hz-MARINE, SO100-440V3-60Hz-MARINE, SO120, SO55, SO55-400V3-50Hz-MARINE, SO55-440V3-60Hz-MARINE, SO55E		

miscellaneous



1

GEV No.	510864	Ref. No.	190607 33519
description	bush for spring holder hood mechanics		
For models:	CA120, CA55, CA90, CAP10, CAP10BT, CAP10DE, CAP12, CAP12DE, CAP12EBT, CAP15EBT, CAP7, CAP7E, ED550, ED650E, ED650S, RCA1100, RCA1200, RCA1200i, SO100, SO100-400V3-50Hz-MARINE, SO100-440V3-60Hz-MARINE, SO120, SO55, SO55-400V3-50Hz-MARINE, SO55-440V3-60Hz-MARINE, SO55E		

GEV No.	511393	Ref. No.	H190149
description	strengthening for handle holder hood mechanics		
For models:	CA120, CA55, CA90, CAP10, CAP10BT, CAP12, CAP7, CAP7E, ED550, ED650E, ED650S, RCA1100, RCA1200, RCA1200i, SO100, SO100-400V3-50Hz-MARINE, SO100-440V3-60Hz-MARINE, SO120, SO55, SO55-400V3-50Hz-MARINE, SO55-440V3-60Hz-MARINE, SO55E		







Зип Общепит
vsezip.ru
+7(812)987-08-81

basket guides			
guide bars			
 <p>1</p>			
GEV No.	510931	Ref. No.	191051 H191051
description	slide guide		
For models:	AC101, AC151, AC181, AC201, AC241, AC91, EDT100, EDT140, EDT170, EDT200, EDT230, EDT85, TR100, TR140, TR170, TR200, TR230, TR90, TR-E100, TR-E150, TR-E170, TR-E200, TR-E230		

miscellaneous			
 <p>1</p>			
GEV No.	512024	Ref. No.	H190620
description	guide L 44mm W 34mm H 20mm		

 <p>1</p>			
GEV No.	511223	Ref. No.	H191019
description	sleeve for magnetic switch L 76mm ø 16mm thread M10x1.5 plastic		
For models:	EDT100, EDT140, EDT170, EDT200, EDT230, EDT85, TR100, TR140, TR170, TR200, TR230, TR90, TR-E90		

air traps				
air traps				
 <p>1</p>				
GEV No.	510347	Ref. No.	161303 H161303	
description	air trap			
For models:	C90DE, C90EBT, C98, CA55, CAP7, CAP7E, ED550, LO62, RCA1100, RCA1200, RCA1200i, SO55, SO55-400V3-50Hz-MARINE, SO55-440V3-60Hz-MARINE, SO55E			
spare parts for	510347			
	GEV No.	510877	Ref. No.	200415 H200415
	flat gasket rubber ED ø 18mm ID ø 10mm thickness 3mm Qty 1 pcs			
	GEV No.	560197	Ref. No.	26758
	nut thread M10 H 8mm WS 17 SS DIN/ISO DIN 934 / ISO 4032/8673 Qty 1 pcs			
accessories for	510347			
	GEV No.	510877	Ref. No.	200415 H200415
	flat gasket rubber ED ø 18mm ID ø 10mm thickness 3mm Qty 1 pcs			



accessories for	510347			
	GEV No.	560197	Ref. No.	26758
	nut thread M10 H 8mm WS 17 SS DIN/ISO DIN 934 / ISO 4032/8673 Qty 1 pcs			

 <p>1</p>			
GEV No.	510759	Ref. No.	161316 25010
description	air trap		
For models:	60BT, 60BT-3, 60EBT, C3, C35, C35E, C4, C43, C43-2, C43ALTA, C43D, C43DE, C43E, C46DE, C46E, C48, C48-2, C48D, C48D-2, C48DDL, C48DL, C48E, C53, C53D, C53DE, C53E, C6, C60, C60D, C60DE, C60E, C68DE, C68E, C68EBT, C6D, C6DE, C6E, C6EBT, CDN3, CDN4, CM43, CM48, CM52, CMD43, CMD48, CMD52, CR43, CR43D, CR48, CR48D... (Other models you can see in the webshop)		

spare parts for	510759			
	GEV No.	502036	Ref. No.	200805 25239
	O-ring EPDM thickness 2.62mm ID ø 28.25mm Qty 1 pcs			

	GEV No.	510760	Ref. No.	161317 25011
	hose connector			

	GEV No.	510761	Ref. No.	25263
	flat gasket rubber D1 ø 38mm D2 ø 25mm thickness 2mm Qty 1 pcs			

accessories for	510759			
	GEV No.	510760	Ref. No.	161317 25011
	hose connector			
	GEV No.	510761	Ref. No.	25263
	flat gasket rubber D1 ø 38mm D2 ø 25mm thickness 2mm Qty 1 pcs			
	GEV No.	512283	Ref. No.	—
	flat gasket rubber D1 ø 38.5mm D2 ø 24.5mm thickness 2mm Qty 1 pcs			







 <p>1</p>				
GEV No.	511199	Ref. No.	131308 H161308	
description	air trap			
For models:	EDI13ALTABT, EDI13BT, EDI4, EDI5, EDI6BT, EDI8BT, EDT100, EDT140, EDT170, EDT200, EDT230, EDT85, LO56, LO61, TR100, TR140, TR170, TR200, TR230, TR90, TR-E100, TR-E150, TR-E170, TR-E200, TR-E230, TR-E90			
accessories for	511199			
	GEV No.	511283	Ref. No.	H200927
	flat gasket rubber ED ø 30mm ID ø 20mm thickness 2mm Qty 1 pcs			
	GEV No.	511284	Ref. No.	270121 H270121
	nut			
	GEV No.	511286	Ref. No.	—
	hose clamp ø 38mm wire gauge ø 3.2mm Qty 1 pcs			

Table continues overleaf

accessories for	511199		
	GEV No.	511289	Ref. No.
			—
	hose ED ø 9.5mm ID ø 5mm L 420mm equiv. no. 161312		

	1		
GEV No.	512258	Ref. No.	29640
description	air trap		
For models:	APS43, APS48, APS48B, APS53, APS60, APSE43, APSE48, APSE53, APSE60, FW35, FW40, FW40B, FW45, FW50		

	1		
GEV No.	512198	Ref. No.	180420
description	air trap L 70mm W 50mm ø 28mm hose ø 8.5mm		
For models:	C6EBT, C81EBT, CAP15EBT, EDI13ALTABT, EDI13BT, EDI6BT, EDI8BT, HT100, HT150, HTP195, HTP205, HTP220		

air trap accessories

	1		
GEV No.	510761	Ref. No.	25263
description	flat gasket rubber D1 ø 38mm D2 ø 25mm thickness 2mm Qty 1 pcs		
For models:	60BT, 60BT-3, 60EBT, APS43, APS48, APS48B, APS53, APS60, APSE43, APSE48, APSE53, APSE60, BPN48, BPS43, BPS52, C3, C35, C35E, C4, C43, C43-2, C43ALTA, C43D, C43DE, C43E, C46DE, C46E, C48, C48-2, C48D, C48D-2, C48DDL, C48DL, C48E, C53, C53D, C53DE, C53E, C6, C60, C60D, C60DE, C60E, C68DE, C68E, C68EBT, C6D, C6DE, C6E, C6EBT...(Other models you can see in the webshop)		

	1		
GEV No.	510877	Ref. No.	200415 H200415
description	flat gasket rubber ED ø 18mm ID ø 10mm thickness 3mm Qty 1 pcs		
For models:	60EBT, AC101, AC151, AC181, AC201, AC241, AC91, C53DE, C53E, C6, C60DE, C60E, C68DE, C68E, C68EBT, C6D, C6DE, C6E, C6EBT, DP45DE, DP45E, DP50DE, DP50E, DP50EBT, EDT100, EDT140, EDT170, EDT200, EDT230, EDT85, HG2LR, HGLR, SP45DE, SP45E, SP5, SP50DE, SP50E, SP50E-400V3-50Hz-MARINE, SP50E-440V3-60Hz-MARINE, SP5D, SP5DE, SP5E, SP68DE, SP68E, ST53DE, ST53E, ST60DE, ST60E, ST60EBT		

	1		
GEV No.	511283	Ref. No.	H200927
description	flat gasket rubber ED ø 30mm ID ø 20mm thickness 2mm Qty 1 pcs		
For models:	C81E, CAP10, CAP10BT, CAP12, EDI13ALTABT, EDI13BT, EDI4, EDI5, EDI6BT, EDI8BT, EDT100, EDT140, EDT170, EDT200, EDT230, EDT85, LO56, LO61, SO100, SO100-400V3-50Hz-MARINE, SO100-440V3-60Hz-MARINE, SO120, SP81E, TR100, TR140, TR170, TR200, TR230, TR90, TR-E100, TR-E150, TR-E170, TR-E200, TR-E230, TR-E90		

Зип Общепит

vsezip.ru

+7(812)987-08-81

	1		
GEV No.	510760	Ref. No.	161317 25011
description	hose connector		
For models:	60BT, 60BT-3, 60EBT, APS43, APS48, APS48B, APS53, APS60, APSE43, APSE48, APSE53, APSE60, BPN48, BPS43, BPS52, C3, C35, C35E, C4, C43, C43-2, C43ALTA, C43D, C43DE, C43E, C46DE, C46E, C48, C48-2, C48D, C48D-2, C48DDL, C48DL, C48E, C53, C53D, C53DE, C53E, C6, C60, C60D, C60DE, C60E, C68DE, C68E, C68EBT, C6D, C6DE, C6E, C6EBT...(Other models you can see in the webshop)		

	1		
GEV No.	511284	Ref. No.	270121 H270121
description	nut		
For models:	AC101, AC151, AC181, AC201, AC241, AC91, C81E, C81EBT, C90DE2, C90E2, C90EBT2, CAP10, CAP10BT, CAP10DE, CAP12, CAP12DE, CAP12EBT, CAP15EBT, CAP7E, EDI13ALTABT, EDI13BT, EDI4, EDI5, EDI6BT, EDI8BT, EDT100, EDT140, EDT170, EDT200, EDT230, EDT85, HD130BT, HD40ALTABT, HD40BT, HD60BT, HD80BT, LO56, LO61, SO100, SO100-400V3-50Hz-MARINE, SO100-440V3-60Hz-MARINE, SO120, SP81E, TR100, TR140, TR170, TR200, TR230, TR90, TR-E100...(Other models you can see in the webshop)		

mechanics for flight type dishwashers

	1		
GEV No.	529234	Ref. No.	620144 620648 H620144
description	drive shaft for transport system		
For models:	AC101, AC151, AC181, AC201, AC241, AC91, EDT100, EDT140, EDT170, EDT200, EDT230, EDT85, TR100, TR140, TR170, TR200, TR230, TR90, TR-E100, TR-E150, TR-E170, TR-E200, TR-E230		

	1		
GEV No.	504361	Ref. No.	H170238
description	lever L 95mm W 30mm H 35mm		



Zip Общепит

vsezip.ru



+7(812)987-08-81

			
1			
GEV No.	504346	Ref. No.	H170314
description	roller for transport system H 19.5mm ø 30mm hole ø 9mm		

backflow preventers

backflow preventers

			
1			
GEV No.	504265	Ref. No.	33506
description	backflow preventer		
For models:	C43-2, C43DE, C43E, C46DE, C46E, C48-2, C48D-2, C53DE, C6, C60DE, C68DE, C68E, C6D, C6DE, CA120, CA55, CA90, CAP10, CAP12, CAP7, DP35-2, DP35D-2, DP40-2, DP40D-2, DP40D-rib2, DP40-rib2, ED550, ED650E, ED650S, GS-X1011, GS-X1011-2, GS-X1011-WEH, GS-X1011-WEH-2, GS-X1021, GS-X1021-2, GS-X1021-2rib, GS-X1021-WEH, GS-X1021-WEH-2, GS-X1021-WEH-2rib, RCA1100, RCA1200, RCA1200i, SO100, SO100-400V3-50Hz-MARINE, SO100-440V3-60Hz-MARINE, SO120, SO55, SO55-400V3-50Hz-MARINE, SO55-440V3-60Hz-MARINE, SP35-2...(Other models you can see in the webshop)		

			
1			
GEV No.	510220	Ref. No.	191095 H191095
description	backflow preventer		
For models:	60BT-3, 60EBT, C68EBT, C6EBT, C81EBT, C90EBT, C90EBT2, CAP10BT, CAP12EBT, CAP15EBT, DP50EBT, EDI13ALTABT, EDI13BT, EDI4, EDI6BT, EDI8BT, LO56, SD5BT, ST48EBT, ST60EBT		
accessories for	510220		
	GEV No.	510226	Ref. No. 180149 H180149
	nut ø 65mm for backflow preventer		
	GEV No.	510234	Ref. No. —
	flat gasket rubber ED ø 65mm ID ø 47mm thickness 2mm Qty 1 pcs		

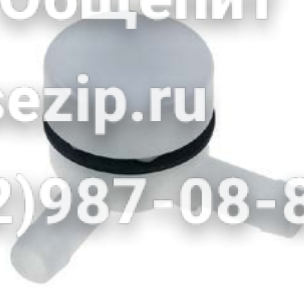
			
1			
GEV No.	512200	Ref. No.	620535 H620535
description	backflow preventer connection 12 90° hose ø 12mm		
For models:	AP43E, AP48E, AP53E, AP60E, C35E, C43-2, C43DE, C43E, C46DE, C46E, C48-2, C48D-2, C53DE, C53E, C6, C60DE, C60E, C68DE, C68E, C6D, C6DE, C6E, CA120, CA55, CA90, CAP10, CAP10DE, CAP12, CAP12DE, CAP7, CAP7E, DP45DE, DP45E, DP50DE, DP50E, ED550, ED650E, ED650S, FW35E, FW40E, SO100, SO120, SO55, SO55E, SP35DE, SP35E, SP40DE, SP40E, SP45DE, SP45E...(Other models you can see in the webshop)		

accessories

			
1			
GEV No.	511277	Ref. No.	33502
description	T-piece thread 1/2" ø 18mm		
For models:	C43-2, C43DE, C43E, C46DE, C46E, C48-2, C48D-2, C53DE, C6, C60DE, C68DE, C68E, C6D, C6DE, CA120, CA55, CA90, CAP10, CAP12, CAP7, DP35-2, DP35D-2, DP40-2, DP40D-2, DP40D-rib2, DP40-rib2, ED550, ED650E, ED650S, GS-X1011, GS-X1011-2, GS-X1011-WEH, GS-X1011-WEH-2, GS-X1021, GS-X1021-2, GS-X1021-2rib, GS-X1021-WEH, GS-X1021-WEH-2, GS-X1021-WEH-2rib, RCA1100, RCA1200, RCA1200i, SO100, SO100-400V3-50Hz-MARINE, SO100-440V3-60Hz-MARINE, SO120, SO55, SO55-400V3-50Hz-MARINE, SO55-440V3-60Hz-MARINE, SP35-2...(Other models you can see in the webshop)		

miscellaneous

			
1			
GEV No.	512063	Ref. No.	33505
description	gasket ID ø 21mm ED ø 30mm thickness 2mm		
For models:	C43-2, C43DE, C43E, C46DE, C46E, C48-2, C48D-2, C53, C53DE, C6, C60, C60DE, C68DE, C68E, C6D, C6DE, C90, CA120, CA55, CA90, CAP10, CAP12, CAP7, DP35-2, DP35D-2, DP40-2, DP40D-2, DP40D-rib2, DP40-rib2, ED550, ED650E, ED650S, EDI13, EDI13ALTA, EDI6, EDI8, GS-X1011, GS-X1011-2, GS-X1011-WEH, GS-X1011-WEH-2, GS-X1021, GS-X1021-2, GS-X1021-2rib, GS-X1021-WEH, GS-X1021-WEH-2, GS-X1021-WEH-2rib, LO134, LO134ALTA, LO50, LO67...(Other models you can see in the webshop)		



1

GEV No.	511394	Ref. No.	25032
description	lid for tank with thread D1 ø 88mm D2 ø 65mm		
For models:	APS43, APS48, APS48B, APS53, APS60, APSE43, APSE48, APSE53, APSE60, C35, C43, C43ALTA, C43D, C48, C48D, C48DDL, C48DL, C53, C53D, C60, C60D, CM43, CM48, CM52, CM60, CR43, CR43D, CR48, CR48D, DP35, DP35-2, DP35D, DP35D-2, DP40, DP40-2, DP40D, DP40D-2, DP40D-rib2, DP40-rib2, DP45, DP45D, DP50, DP50D, E40, E43, E50, FW35, FW40, FW40B, FW45...(Other models you can see in the webshop)		
accessories for	511394		
	GEV No.	Ref. No.	
	511395	25245	
	O-ring EPDM thickness 2.62mm ID ø 71.12mm Qty 1 pcs		
	GEV No.	Ref. No.	
	511396	25008	
	nut		



1

GEV No.	510349	Ref. No.	160755
description	plug D1 ø 87mm mounting ø 72mm ID ø 60mm		
For models:	60EBT, C43DE, C43E, C46DE, C46E, C53DE, C53E, C60DE, C60E, C68DE, C68E, C6DE, C6E, DP45DE, DP45E, DP50DE, DP50E, SP35DE, SP35E, SP40DE, SP40E, SP50DE, SP50E, ST53DE, ST53E, ST60DE, ST60E		
accessories for	510349		
	GEV No.	Ref. No.	
	510947	—	
	flat gasket rubber ED ø 85mm ID ø 73mm thickness 2mm Qty 1 pcs equiv. no. 200489 suitable for COMENDA		

door mechanics

bolts



1

GEV No.	502260	Ref. No.	15995
description	adaptor ø 7mm L 21.5mm thread M6 for door SS		
For models:	60BT, 60BT-3, APS43, APS48, APS48B, APS53, APS60, APSE43, APSE48, APSE53, APSE60, C3, C35, C4, C43, C43-2, C43ALTA, C43D, C48, C48-2, C48D, C48D-2, C48DDL, C48DL, C48E, C53, C53D, C6, C60, C60D, C6D, C81, C81E, C81EBT, C90, C90DE, C90DE2, C90E, C90E2, C90EBT, C90EBT2, C98, CDN3, CDN4, CR43, CR43D, CR48, CR48D, DP35, DP35-2...(Other models you can see in the webshop)		

Зип Общепит

vsezip.ru
+7(812)9800081

1

GEV No.	511392	Ref. No.	33444
description	bearing bolt		
For models:	CA120, CA55, CA90, CAP7, CAP7E, ED550, ED650E, ED650S, RCA1100, RCA1200, RCA1200i, SO35, SO35-400V3-50Hz-MARINE, SO55-440V3-50Hz-MARINE, SO55E		

springs

tension springs



1

GEV No.	510064	Ref. No.	36860 450298
description	tension spring ø 13mm total length 78mm wire gauge ø 2.5mm L1 14mm L2 50mm L3 14mm		
For models:	60EBT, C60DE, C60E, C68DE, C68E, C68EBT, C6DE, C6E, C6EBT, SP50DE, SP50E, SP68DE, SP68E		

linkage



1

GEV No.	512201	Ref. No.	34860
description	bar L 540mm thread M8x1.25 angled W 28.5mm ø 12mm		
For models:	EDI13, EDI13-2, EDI13ALTA, EDI13ALTA-2, EDI13BT, EDI6, EDI6-2, EDI6BT, EDI8, EDI8-2, EDI8BT, HD130BT, HD40ALTABT, HD40BT, HD60BT, HD80BT, LO134, LO134-2, LO134ALTA, LO134ALTA-2, LO67, LO67-2, LO83, LO83-2, RLO200, RLO300, RLO400		



1

GEV No.	512370	Ref. No.	34142
description	door pin tie bar		
For models:	APS43, APS48, APS48B, APS53, C35, C43, C43-2, C43ALTA, C43D, C48, C48-2, C48D, C48D-2, C48DDL, C48DL, C48E, C53, C53D, C60, C60D, CDN3, CDN4, CR43, CR43D, CR48, CR48D, DP35, DP35-2, DP35D, DP35D-2, DP40, DP40-2, DP40D, DP40D-2, DP40D-rib2, DP40-rib2, DP45, DP45D, FW35, FW40, FW40B, FW45, GS-X1011, GS-X1011-2, GS-X1011-WEH, GS-X1011-WEH-2, GS-X1021, GS-X1021-2, GS-X1021-2rib, GS-X1021-WEH...(Other models you can see in the webshop)		



1

GEV No.	519413	Ref. No.	34827
description	end stop for tie bar		
For models:	C90, LO50, RLO50, US-X501		



1

GEV No.	519412	Ref. No.	34440
description	tie bar L 234mm thread M5 ø 4.4mm		
For models:	C81, C90, LO50, RLO50, SP81, US-X501		





Зип Общепит

vsezip.ru

7(812)987-08-81



1 			
GEV No.	512026	Ref. No.	34144
description	tie bar L 235mm thread M5		
For models:	60BT, 60BT-3, APS48, APS48B, APS60, C48, C48D, C48DDL, C53, C53D, C6, C60, C60D, C6D, CR48, CR48D, DP50, DP50D, DP50D-115V, FW40, FW50, RSP50, RSP50A, SD5BT, SP5, SP50, SP50-400V, SP50-440V, SP50D, SP5D, STS60, STS60D, TN-TDN6, VS-X313, VS-X313-LP-DOS, VS-X515, VS-X515-LP-DOS		

threaded shafts			
1 			
GEV No.	512371	Ref. No.	34143
description	threaded part threaded part		
For models:	60BT, 60BT-3, APS43, APS48, APS48B, APS53, APS60, C35, C43, C43-2, C43ALTA, C43D, C48, C48-2, C48D, C48D-2, C48DDL, C48DL, C48E, C53, C53D, C6, C60, C60D, C6D, C81, C90, CDN3, CDN4, CR43, CR43D, CR48, CR48D, DP35, DP35-2, DP35D, DP35D-2, DP40, DP40-2, DP40D, DP40D-2, DP40D-rib2, DP40-rib2, DP45, DP45D, DP50, DP50D, DP50D-115V, FW35, FW40...(Other models you can see in the webshop)		

sliding plates			
1 			
GEV No.	510492	Ref. No.	160905 H331461
description	sliding plate for tie bar		
For models:	60BT, 60BT-3, APS43, APS48, APS48B, APS53, APS60, C35, C43, C43-2, C43ALTA, C43D, C48, C48-2, C48D, C48D-2, C48DDL, C48DL, C48E, C53, C53D, C6, C60, C60D, C6D, CDN3, CDN4, CR43, CR43D, CR48, CR48D, DP35, DP35-2, DP35D, DP35D-2, DP40, DP40-2, DP40D, DP40D-2, DP40D-rib2, DP40-rib2, DP45, DP45D, DP50, DP50D, DP50D-115V, FW35, FW40, FW40B, FW45...(Other models you can see in the webshop)		

1 			
GEV No.	511371	Ref. No.	H160909
description	sliding plate sliding plate		
For models:	APS43, APS48, APS48B, APS53, APS60, C81, C90, DP35, DP35-2, DP35D, DP35D-2, DP40, DP40-2, DP40D, DP40D-2, DP40D-rib2, DP40-rib2, DP45, DP45D, DP50, DP50D, FW35, FW40, FW40B, FW45, FW50, LO50, RLO50, SP81, STS43, STS43-2, STS43D, STS43D-2, STS48, STS48-2, STS48D, STS48D-2, STS48D-rib2, STS48-rib2, STS53, STS53D, STS60, STS60D, US-X501		

1 			
GEV No.	501444	Ref. No.	37339 450250+324170+190685
description	door hinge kit HOONVED		
For models:	AP43E, AP48E, AP53E, AP60E, DP45DE, DP45E, DP50DE, DP50E, FW35E, FW40E, ST43DE, ST43E, ST48DE, ST48E, ST53DE, ST53E, ST60DE, ST60E		

1 			
GEV No.	501443	Ref. No.	324170
description	door hinge L 150mm HOONVED		
For models:	AP43E, AP48E, AP53E, AP60E, DP45DE, DP45E, DP50DE, DP50E, DP50EBT, FW35E, FW40E, ST43DE, ST43E, ST48DE, ST48E, ST48EBT, ST53DE, ST53E, ST60DE, ST60E, ST60EBT		
spare parts for	501443		
	GEV No.	512405	Ref. No. 190685
	bush for door hinge plastic ø 10mm L 9mm		

hinge pins			
1 			
GEV No.	511375	Ref. No.	15568 342087 H15568
description	hinge pin ø 6mm D1 ø 4mm L 55mm thread M4 stainless steel		
For models:	60BT, 60BT-3, 60EBT, APS43, APS48, APS48B, APS53, APS60, C35, C35E, C43, C43-2, C43ALTA, C43D, C43DE, C43E, C46DE, C46E, C48, C48-2, C48D, C48D-2, C48DDL, C48DL, C48E, C53, C53D, C53DE, C53E, C6, C60, C60D, C60DE, C60E, C68DE, C68E, C68EBT, C6D, C6DE, C6E, C81, C81E, C81EBT, C90, C90DE, C90DE2, C90E, C90E2, C90EBT, C90EBT2...(Other models you can see in the webshop)		

1 			
GEV No.	511628	Ref. No.	H341927
description	hinge pin ø 6mm L 60mm thread M6x1 stainless steel		
For models:	C53DE, C53E, C60DE, C60E, SP45DE, SP45E, SP50DE, SP50E		

doors



1

GEV No.	524533	Ref. No.	36898 37531+200217+323724+323725+2x450
description	door kit for dishwasher W 589mm H 451mm		
For models:	60EBT, C53E, C60DE, C60E, C6DE, C6E, SP50DE, SP50E, SP50E-400V3-50Hz RINE, SP50E-440V3-60Hz-MARINE, SP5DE, SP5E		

Зип Общепит

vsezip.ru

+7(812)987 08 81



1

GEV No.	512369	Ref. No.	25052
description	counterpart door catch		
For models:	CM43, CM48, CM52, CM60, CMD43, CMD48, CMD52, CMD60, E36, E40, E40-2F, E43, E50, K80F, K80G, M60, NK43, NK48, NK52, NK60, NKD43, NKD48, NKD52, NKD60, T3-80, T4-80, T5-80, T6-80, TS43, TS48		



1

GEV No.	512160	Ref. No.	20018
description	door catch		
For models:	CM43, CM48, CM52, CM60, CMD43, CMD48, CMD52, CMD60, E36, E40, E40-2F, E43, E50, K80F, K80G, M60, NK43, NK52, NK60, NKD43, NKD48, NKD52, NKD60, T3-80, T4-80, T5-80, T6-80, TS43, TS48		

accessories for	512160	GEV No.	512369	Ref. No.	25052

door bumpers



1

GEV No.	510957	Ref. No.	190619 H190619
description	door bumper end stop		
For models:	60BT, 60BT-3, APS43, APS48, APS48B, APS53, APS60, C35, C43, C43-2, C43ALTA, C43D, C48, C48-2, C48D, C48D-2, C48DDL, C48DL, C48E, C53, C53D, C6, C60, C60D, C6D, C81, CDN3, CDN4, CR43, CR43D, CR48, CR48D, DP35, DP35-2, DP35D, DP35D-2, DP40, DP40-2, DP40D, DP40D-2, DP40D-rib2, DP40-rib2, DP45, DP45D, DP50, DP50D, DP50D-115V, FW35, FW40, FW40B...(Other models you can see in the webshop)		



1

GEV No.	512368	Ref. No.	22121
description	door catch catch		
For models:	APS43, APS48, APS53, APS60, APSE43, APSE48, APSE53, APSE60, C3, C4, FW35, FW40, FW45, FW50		

locks



1

GEV No.	511165	Ref. No.	331116 H331116
description	catch hook for door		
For models:	AC101, AC151, AC181, AC201, AC241, AC91, EDT100, EDT140, EDT170, EDT200, EDT230, EDT85, TR100, TR140, TR170, TR200, TR230, TR90, TR-E100, TR-E150, TR-E170, TR-E200, TR-E230, TR-E90		





1



GEV No.	510008	Ref. No.	33336
description	door catch for dishwasher		
For models:	60BT, 60BT-3, 60EBT, APS43, APS48, APS48B, APS53, APS60, APSE43, APSE48, APSE53, APSE60, C35, C35E, C43, C43-2, C43ALTA, C43D, C43DE, C43E, C46DE, C46E, C48, C48-2, C48D, C48D-2, C48DDL, C48DL, C48E, C53, C53D, C53DE, C53E, C6, C60, C60D, C60DE, C60E, C68DE, C68E, C68EBT, C6D, C6DE, C6E, C81, C81E, C81EBT, C90, C90DE, C90DE2...(Other models you can see in the webshop)		





Зип Общепит
vsezip.ru
+7(812)987-08-81

			
1			
GEV No.	692100	Ref. No.	180508 37198
description	snap lock L 36mm ø 17mm		
For models:	60EBT, C60DE, C60E, C6DE, C6E, C6EBT, SP50DE, SP50E		

miscellaneous			
			
1			
GEV No.	519411	Ref. No.	18069
description	bracket for door hinge		
For models:	APS43, APS48, APS48B, APS53, APS60, APSE43, APSE48, APSE53, APSE60, C3, C35, C4, C43, C43ALTA, C43D, C48, C48D, C48DDL, C48DL, C53, C53D, C60, C60D, CDN3, CDN4, CR43, CR43D, CR48, CR48D, DP35, DP35D, DP40, DP40D, DP45, DP45D, DP50, DP50D, FW35, FW40, FW40B, FW45, FW50, SP35, SP35ALTA, SP35D, SP40, SP40D, SP40DDL, SP40DL, SP45...(Other models you can see in the webshop)		

			
1			
GEV No.	512405	Ref. No.	190685
description	bush for door hinge plastic ø 10mm L 9mm		
For models:	AP43E, AP48E, AP53E, AP60E, DP45DE, DP45E, DP50DE, DP50E, DP50EBT, FW35E, FW40E, ST43DE, ST43E, ST48DE, ST48E, ST48EBT, ST53DE, ST53E, ST60DE, ST60E, ST60EBT		
accessories for	512405		
	GEV No.	501443	Ref. No.
			324170
	door hinge L 150mm HOONVED		

			
1			
GEV No.	512103	Ref. No.	31817
description	cam door catch		
For models:	BPN48, BPS43, BPS52, INDY43F, INDY48F, INDY53F, INDY60F, UNI43C, UNI43R, UNI43RD, UNI48C, UNI48CD, UNI48R, UNI48RD, UNI53C, UNI53R, UNI53RD, UNI60C		

			
1			
GEV No.	512104	Ref. No.	31956
description	cover for cam connection housing		
For models:	BPN48, INDY43F, INDY48F, INDY53F, INDY60F, UNI43C, UNI43R, UNI43RD, UNI48C, UNI48CD, UNI48R, UNI48RD, UNI53C, UNI53R, UNI53RD, UNI60C		

			
1			
GEV No.	510938	Ref. No.	H331764
description	fixing plate for door seal fixing plate		
For models:	EDI13-2, EDI13ALTA-2, EDI4, EDI6-2, EDI8-2, LO134-2, LO134ALTA-2, LO56, LO67-2, LO83-2		

			
1			
GEV No.	524451	Ref. No.	35202
description	threaded bush for tie bar L 12mm D1 ø 9.6mm D2 ø 7.75mm		
For models:	C90, LO50, RLO50, US-X501		

screw connections			
			
1			
GEV No.	512313	Ref. No.	30436
description	nut		
For models:	E40-2F, INDY43F, INDY48F, INDY53F, INDY60F, TS43, TS48, UNI43C, UNI48C, UNI48CD, UNI53C, UNI60C		

			
1			
GEV No.	510457	Ref. No.	H160755
description	nut for stuff		
For models:	60EBT, C43DE, C43E, C46DE, C46E, C53DE, C53E, C60DE, C60E, C68DE, C68E, C6DE, C6E, SP35DE, SP35E, SP40DE, SP40E, SP45DE, SP45E, SP50DE, SP50E, SP50E-400V3-50Hz-MARINE, SP50E-440V3-60Hz-MARINE, SP5DE, SP5E, SP68DE, SP68E, ST53DE, ST53E, ST60DE, ST60E		

			
1			
GEV No.	512074	Ref. No.	26651
description	nut thread 1/2" H 7mm WS 27 plastic Qty 1 pcs		
For models:	ED600-95, ED630-90, ED650S, ED650S-90, ED700, ED700-90, ED900, ED900-90, EDI13, EDI13-2, EDI13ALTA, EDI13ALTA-2, EDI6, EDI6-2, EDI8, EDI8-2, K80F, K80G, LO122, LO134, LO134-2, LO134ALTA, LO134ALTA-2, LO60, LO67, LO67-2, LO78, LO83, LO83-2, RLO200, RLO300, RLO400, T3-80, T4-80, T5-80		

Зип-Общепит

curtains

curtains

vsezip.ru

+7(812)987-08-81

1

GEV No.	510941	Ref. No.	190910 H190906
description	curtain W 620mm H 473mm N25		
For models:	EDT100, EDT140, EDT170, EDT200, EDT230, EDT85, TR100, TR140, TR170, TR200, TR230, TR90, TR-E100, TR-E150, TR-E170, TR-E200, TR-E230, TR-E90		

curtain rods

1

GEV No.	533175	Ref. No.	340422 H340422
description	curtain rod L 660mm ø 8mm		
For models:	AC101, AC151, AC181, AC201, AC241, AC91, EDT100, EDT140, EDT170, EDT200, EDT230, EDT85, TR100, TR140, TR170, TR200, TR230, TR90, TR-E100, TR-E150, TR-E170, TR-E200, TR-E230, TR-E90		

washing and rinsing systems

1

GEV No.	512233	Ref. No.	17922
description	blank thread 1/4" WS 24		
For models:	APS43, APS48, APS48B, APS53, APS60, APSE43, APSE48, APSE53, APSE60, FW35, FW40, FW40B, FW45, FW50		



1

GEV No.	511576	Ref. No.	160789
description	nut thread M10x1.5 H 5mm WS 19 plastic Qty 1 pcs		
For models:	CAP15EBT		



1

GEV No.	512382	Ref. No.	18463
description	screw connection for wash arm		



1

GEV No.	512177	Ref. No.	33476
description	screw connection thread 1/4" H 27mm Qty 1 pcs		
For models:	C98, CA120, CA55, CA90, CAP7, CAP7E, ED550, ED650E, ED650S, LO62, RCA1100, RCA1200, RCA1200i, SO55, SO55-400V3-50Hz-MARINE, SO55-440V3-60Hz-MARINE, SO55E		



1

GEV No.	512178	Ref. No.	33540
description	screw connection thread M16x1.25 H 31mm Qty 1 pcs		
For models:	C98, CA120, CA55, CA90, CAP7, CAP7E, ED550, ED650E, ED650S, LO62, RCA1100, RCA1200, RCA1200i, SO55, SO55-400V3-50Hz-MARINE, SO55-440V3-60Hz-MARINE, SO55E		





Зип Общепит
vsezip.ru
7(812)987-08-81



1

GEV No.	512240	Ref. No.	32282
description	bush for rinse arm		
For models:	APS43, APS48, APS48B, APS53, APSE43, APSE48, APSE53, FW35, FW40, FW40B, FW45		



1

GEV No.	512040	Ref. No.	25056
description	bush for wash arm		
For models:	ED630-90, ED650E, ED650E-90, ED650S, ED650S-90, ED700, ED900, T5-80		



1

GEV No.	512262	Ref. No.	H190641
description	bush for rinse arm		
For models:	C90DE2, C90E2, C90EBT2, C98, CA120, CA90, CAP10, CAP10BT, CAP12, CAP7, CAP7E, ED650E, ED650S, EDI13-2, EDI13ALTA-2, EDI13ALTABT, EDI13BT, EDI4, EDI6-2, EDI6BT, EDI8-2, EDI8BT, LO134-2, LO134ALTA-2, LO56, LO62, LO67-2, LO83-2, RCA1100, RCA1200, RCA1200i, SO100, SO100-400V3-50Hz-MARINE, SO100-440V3-60Hz-MARINE, SO120, SO55, SO55E		



1

GEV No.	512047	Ref. No.	30402
description	bush for wash arm		
For models:	DP35, DP35D, INDY43F, INDY48F, STS43, STS43D, TS48, UNI43C, UNI48C, UNI48CD		



1

GEV No.	511240	Ref. No.	35968
description	bush for wash arm		
For models:	C81, C81E, C81EBT, CA120, CA55, CA90, CAP10, CAP10BT, CAP10DE, CAP12, CAP12DE, CAP12EBT, CAP7, CAP7E, ED550, ED650E, ED650S, RCA1100, RCA1200, RCA1200i, SO100, SO100-400V3-50Hz-MARINE, SO100-440V3-60Hz-MARINE, SO120, SO55, SO55E, SP81, SP81E		



1

GEV No.	512050	Ref. No.	17972
description	bush for wash arm		
For models:	C53, C53D, C60, C60D, DP40, DP40D, DP45, DP45D, DP50, DP50D, INDY53F, INDY60F, SP45, SP45D, SP50, SP50-400V, SP50-440V, SP50D, STS48, STS48D, STS53, STS53D, STS60, STS60D, UNI53C, UNI60C		



1

GEV No.	511432	Ref. No.	33468
description	bush for wash arm		
For models:	C81, CA120, CA55, CA90, ED550, ED650E, ED650S, RCA1100, RCA1200, RCA1200i, SP81		



1

GEV No.	512053	Ref. No.	17971
description	bush for wash arm		
For models:	INDY43F, INDY48F, INDY53F, INDY60F, UNI43C, UNI48C, UNI48CD, UNI53C, UNI60C		



1

GEV No.	511434	Ref. No.	36188
description	bush for wash arm		
For models:	C81, C81E, C81EBT, CA120, CA55, CA90, CAP10, CAP10BT, CAP10DE, CAP12, CAP12DE, CAP12EBT, CAP7, CAP7E, ED550, ED650E, ED650S, RCA1100, SO100, SO100-400V3-50Hz-MARINE, SO100-440V3-60Hz-MARINE, SO120, SO55, SO55E, SP81, SP81E		



1

GEV No.	512062	Ref. No.	18703
description	bush for wash arm		
For models:	60BT, 60BT-3, C3, C4, C53, C53D, C60, C60D, DP35, DP35D, DP40, DP40D, DP45, DP45D, DP50, DP50D, DP50D-115V, GS-X1021, GS-X1021-WEH, RSP50, RSP50A, SD5BT, SP45, SP45D, SP50, SP50-400V, SP50-440V, SP50D, STS43, STS43D, STS48, STS48D, STS53, STS53D, STS60, STS60D, TN-TDN5, TN-TDN6, VS-X313, VS-X313-LP-DOS, VS-X515, VS-X515-LP-DOS		

Зип Общепит

vsezip.ru

+7(812)987-08-81

			
1			
GEV No.	512064	Ref. No.	32838
description	bush for wash arm		
For models:	60BT, 60BT-3, C53, C53D, C60, C60D, DP45, DP45D, DP50, DP50D, DP50D-115V, RSP50, RSP50A, SD5BT, SP45, SP45D, SP50, SP50-400V, SP50-440V, SP50D, STS43, STS43D, STS48, STS48D, STS53, STS53D, STS60, STS60D, TN-TDN5, TN-TDN6, VS-X313, VS-X313-LP-DOS, VS-X515, VS-X515-LP-DOS		

			
1			
GEV No.	511433	Ref. No.	36187
description	bush \varnothing 23mm H 20mm		
For models:	C81, C81E, C81EBT, CA120, CA55, CA90, CAP10, CAP10BT, CAP10DE, CAP12, CAP12DE, CAP12EBT, CAP7, CAP7E, ED550, ED650E, ED650S, RCA1100, SO100, SO100-400V3-50Hz-MARINE, SO100-440V3-60Hz-MARINE, SO120, SO55, SO55E, SP81, SP81E		

			
1			
GEV No.	512275	Ref. No.	34262
description	bush for wash arm		
For models:	60BT, 60BT-3, C53, C53D, C60, C60D, DP35, DP35D, DP40, DP40D, DP45, DP45D, DP50, DP50D, DP50D-115V, GS-X1021, GS-X1021-WEH, RSP50, RSP50A, SD5BT, SP45, SP45D, SP50, SP50-400V, SP50-440V, SP50D, STS43, STS43D, STS48, STS48D, STS53, STS53D, STS60, STS60D, TN-TDN5, TN-TDN6, VS-X313, VS-X313-LP-DOS, VS-X515, VS-X515-LP-DOS		

			
1			
GEV No.	513318	Ref. No.	190697
description	bush \varnothing 32mm H 28mm thread 3/4" ID \varnothing 15.8mm Qty 1 pcs		
For models:	HT100, HT150, HTP195, HTP205, HTP220		

			
1			
GEV No.	512291	Ref. No.	25057
description	bush for wash arm		
For models:	K80F, M60, T3-80, T4-80, T6-80		

			
1			
GEV No.	512211	Ref. No.	34383
description	bushing for rinse arm		
For models:	60BT, 60BT-3, 60EBT, C35, C43, C43D, C48, C48D, C53, C53D, C53DE, C53E, C60, C60D, C60DE, C60E, C81, C81E, C90, C90DE, C90E, C90EBT, DP35, DP35-2, DP35D, DP35D-2, DP40, DP40-2, DP40D, DP40D-2, DP40D-rib2, DP40-rib2, DP45, DP45D, DP50, DP50D, DP50D-115V, EDI13, EDI13ALTA, EDI6, EDI8, GS-X1021, GS-X1021-2, GS-X1021-2rib, GS-X1021-WEH, GS-X1021-WEH-2, GS-X1021-WEH-2rib, LO134, LO134ALTA, LO50...(Other models you can see in the webshop)		

			
1			
GEV No.	512321	Ref. No.	35233
description	bush for wash arm		
For models:	DP35-2, DP35D-2, DP40-2, DP40D-2, DP40D-rib2, DP40-rib2, GS-X1021-2, GS-X1021-2rib, GS-X1021-WEH-2, GS-X1021-WEH-2rib, ST43DE, ST43E, ST48DE, ST48E, ST48EBT, STS43-2, STS43D-2, STS48-2, STS48D-2, STS48D-rib2, STS48-rib2, TDN4-2rib		

			
1			
GEV No.	519571	Ref. No.	H180406
description	connecting fitting for wash distributor L 220mm W 120mm H 60mm ED \varnothing 51mm hole \varnothing 42mm thickness 4.75mm		
For models:	EDT100, EDT140, EDT170, EDT200, EDT230, EDT85, TR100, TR140, TR170, TR200, TR230, TR90, TR-E100, TR-E150, TR-E170, TR-E200, TR-E230, TR-E90		
accessories for	519571		
	GEV No.	519462	Ref. No.
			200428 H200428
	gasket L 100mm W 100mm		
	GEV No.	520118	Ref. No.
			—
	hose clamp \varnothing 50-70mm width 9mm Qty 5 pcs DIN 3017		

			
1			
GEV No.	512383	Ref. No.	31281
description	bush for wash arm		
For models:	INDY43F, INDY48F, INDY53F, INDY60F, TS43, TS48		





Зип Общепит
vsezip.ru
+7(812)987-08-81

			
1			
GEV No.	517796	Ref. No.	06785
description	connecting piece for rinse arm ID \varnothing 7mm ED \varnothing 10.7mm L 18mm		
For models:	APS43, APS48, APS48B, APS53, APS60, C3, C4, FW35, FW40, FW40B, FW45, FW50		

			
1			
GEV No.	512259	Ref. No.	30664
description	flange for wash arm support		
For models:	C53, C53D, C60, C60D, DP40, DP40D, DP45, DP45D, DP50, DP50D, E40-2F, INDY43F, INDY48F, INDY53F, INDY60F, SP45, SP45D, SP50, SP50-400V, SP50-440V, SP50D, STS48, STS48D, STS53, STS53D, STS60, STS60D, TS48, UNI43C, UNI48C, UNI48CD, UNI53C, UNI60C		

			
1			
GEV No.	512406	Ref. No.	30662
description	cover for washing arms ID \varnothing 48mm ED \varnothing 79mm thickness 8.5mm		
For models:	E40-2F, INDY43F, INDY48F, INDY53F, INDY60F, TS43, TS48		



			
1			
GEV No.	505399	Ref. No.	200977
description	gasket for wash arm \varnothing 21mm ID \varnothing 12mm thickness 5mm		

			
1			
GEV No.	517629	Ref. No.	25039
description	disc for rinse arm \varnothing 12/18mm		
For models:	ED630-90, ED650E-90, ED650S-90, ED700, ED900		

			
1			
GEV No.	505314	Ref. No.	31063
description	gasket for wash arm thickness 1mm L 74.5mm W 42mm		
For models:	ED600-95, ED700-90, ED900-90, EDI5, LO122, LO60, LO61, LO78		

			
1			
GEV No.	517628	Ref. No.	25038
description	disc for rinse arm \varnothing 16mm		
For models:	ED630-90, ED650E-90, ED650S-90, ED700, ED900		

			
1			
GEV No.	519462	Ref. No.	200428 H200428
description	gasket L 100mm W 100mm		

			
1			
GEV No.	507571	Ref. No.	180407 H180407
description	end piece for wash distributor L 170mm W 120mm H 60mm ED \varnothing 51mm hole \varnothing 41mm thickness 4.75mm suitable for COMENDA for ACxxx		
For models:	AC101, AC151, AC181, AC201, AC241, AC91, EDT100, EDT140, EDT170, EDT200, EDT230, EDT85, TR100, TR140, TR170, TR200, TR230, TR90, TR-E100, TR-E150, TR-E170, TR-E200, TR-E230, TR-E90		
accessories for	507571		
	GEV No.	519462	Ref. No.
			200428 H200428
	gasket L 100mm W 100mm		
	GEV No.	520118	Ref. No.
			—
	hose clamp \varnothing 50-70mm width 9mm Qty 5 pcs DIN 3017		

			
1			
GEV No.	512061	Ref. No.	18691
description	hose connector thread 1/2"		
For models:	C3, C35, C4, C43, C43ALTA, C43D, C48, C48D, C48DDL, C48DL, SP35, SP35ALTA, SP35D, SP40, SP40D, SP40DDL, SP40DL, SPB35		



1

GEV No.	512245	Ref. No.	33544
description	hose connector thread 1/2" grommet ø 30mm ID ø 16mm grommet length 28mm total length 35mm ED ø 31.5mm		
For models:	60BT, 60BT-3, C43, C43ALTA, C48, C48D, C48DDL, C48DL, C53, C53D, C60, C60D, DP35, DP35D, DP40, DP40D, DP45, DP45D, DP50, DP50D, DP50D-115V, GS-X1021, GS-X1021-WEH, GS-X1021, GS-X1021-WEH, RSP50, RSP50A, SD5BT, SP35, SP35ALTA, SP40, SP40D, SP40DDL, SP40DL, SP45, SP45D, SP50, SP50-400V, SP50-440V, SP50D, STS43, STS43D, STS48, STS48D, STS53, STS53D, STS60, STS60D, TN-TDN5, TN-TDN6...(Other models you can see in the webshop)		

Зип Общепит

vsezip.ru

+7(812)987 08 81



1

GEV No.	512212	Ref. No.	34998
description	knurled nut thread M10x1.5 ø 30mm H 6.4mm SS		
For models:	60EBT, C53DE, C53E, C60DE, C60E, C81, C81E, C81EBT, C90, C90DE, C90E, C90EBT, DP35-2, DP35D-2, DP40-2, DP40D-2, DP40D-rib2, DP40-rib2, DP45DE, DP45E, DP50DE, DP50E, DP50EBT, EDI13, EDI13ALTA, EDI6, EDI8, GS-X1021-2, GS-X1021-2rib, GS-X1021-WEH-2, GS-X1021-WEH-2rib, LO134, LO134ALTA, LO50, LO50E, LO67, LO83, RLO200, RLO300, RLO400, RLO50, SMW15, SMW15E, SP45DE, SP45E, SP50DE, SP50E, SP50E-400V3-50Hz-MARINE, SP50E-440V3-60Hz-MARINE, SP81...(Other models you can see in the webshop)		



2

GEV No.	512085	Ref. No.	31165
description	impulse nozzle		



1

GEV No.	512038	Ref. No.	31659
description	manifold		
For models:	INDY48F, UNI48C, UNI48CD		



1

GEV No.	698577	Ref. No.	36006
description	knurled nut mounting pos. upper/lower thread M18 ø 35.3mm H 6mm SS		
For models:	C81E, C81EBT, C90, C90DE, C90DE2, C90E, C90E2, C90EBT, C90EBT2, C98, CA55, CA90, CAP10, CAP10BT, CAP10DE, CAP12, CAP12DE, CAP12EBT, CAP7, CAP7E, ED550, ED650E, ED650S, EDI13, EDI13-2, EDI13ALTA, EDI13ALTA-2, EDI13ALTABT, EDI13BT, EDI4, EDI6, EDI6-2, EDI6BT, EDI8, EDI8-2, EDI8BT, HD130BT, HD40ALTABT, HD40BT, HD60BT, HD80BT, LO134, LO134-2, LO134ALTA, LO134ALTA-2, LO50, LO50E, LO56, LO62, LO67...(Other models you can see in the webshop)		



1

GEV No.	512042	Ref. No.	25055
description	nut		
For models:	ED630-90, ED650E, ED650E-90, ED650S, ED650S-90, ED700, ED900, K80F, M60, T3-80, T4-80, T5-80, T6-80		



1

GEV No.	512257	Ref. No.	34382
description	knurled nut thread M10L ø 30mm H 6.5mm SS		
For models:	60BT, 60BT-3, C35, C43, C43D, C48, C48D, C53, C53D, C60, C60D, C81, C90, DP35, DP35D, DP40, DP40D, DP45, DP45D, DP50, DP50D, DP50D-115V, GS-X1021, GS-X1021-WEH, LO50, RSP50, RSP50A, SD5BT, SP35, SP35D, SP40, SP40D, SP45, SP45D, SP50, SP50-400V, SP50-440V, SP50D, SP81, SPB35, STS43, STS43D, STS48, STS48D, STS53, STS53D, STS60, STS60D, TN-TDN5, TN-TDN6...(Other models you can see in the webshop)		



1

GEV No.	512377	Ref. No.	27155
description	nut		
For models:	60BT, 60BT-3, 60EBT, AP43E, AP48E, AP53E, AP60E, APS43, APS48, APS48B, APS53, APS60, APSE43, APSE48, APSE53, APSE60, BPS43, C35, C35E, C43, C43-2, C43ALTA, C43D, C43DE, C43E, C46DE, C46E, C48, C48-2, C48D, C48D-2, C48DDL, C48DL, C48E, C53, C53D, C53DE, C53E, C6, C60, C60D, C60DE, C60E, C68DE, C68E, C68EBT, C6D, C6DE, C6E, C6EBT...(Other models you can see in the webshop)		





1



GEV No.	512244	Ref. No.	32359
description	nut for wash arm		
For models:	APS43, APS48, APS48B, APS53, APS60, APSE43, APSE48, APSE53, APSE60, C3, C4, C53, C53D, C60, C60D, DP35, DP35D, DP40, DP40D, DP45, DP45D, DP50, DP50D, FW35, FW40, FW40B, FW45, FW50, SP45, SP45D, SP50, SP50-400V, SP50-440V, SP50D, STS43, STS43D, STS48, STS48D, STS53, STS53D, STS60, STS60D		





Зип Общепит
vsezip.ru
+7(812)987-08-81

			
1			
GEV No.	512157	Ref. No.	15362
description	nut thread M12		
For models:	APS60, APSE60, ED650E, ED650S, FW50, K80F		

			
1			
GEV No.	512242	Ref. No.	17915
description	rinse pipe		
For models:	APS60, APSE60, FW50		

			
1			
GEV No.	518085	Ref. No.	180232 H180232
description	opposite support for wash arm mounting pos. upper/lower L 102mm W 102mm		
accessories for	518085		
	GEV No.	510899	Ref. No. 200830 H200830
	O-ring EPDM thickness 3.53mm ID ø 37.69mm Qty 1 pcs		
	GEV No.	519462	Ref. No. 200428 H200428
	gasket L 100mm W 100mm		

			
1			
GEV No.	512248	Ref. No.	17913
description	rinse pipe		
For models:	APS43, APS48, APS48B, APS53, APSE43, APSE48, APSE53, DP35, DP35D, DP40, DP40D, FW35, FW40, FW40B, FW45, STS43, STS43D, STS48, STS48D, STS60, STS60D		

			
1			
GEV No.	510801	Ref. No.	160113 H160113
description	pipe ID ø 8mm ø 12mm plastic supplied by meter		
For models:	AC101, AC151, AC181, AC201, AC241, AC91, EDT100, EDT140, EDT170, EDT200, EDT230, EDT85, HG2LR, HGLR, TR100, TR140, TR170, TR200, TR230, TR90, TR-E100, TR-E150, TR-E170, TR-E200, TR-E230		

			
1			
GEV No.	512250	Ref. No.	17938
description	rinse pipe		
For models:	APS60, APSE60, FW50		

			
1			
GEV No.	511668	Ref. No.	H190674
description	reducer for wash pipe ø 18mm		
For models:	CAP10, CAP10BT, CAP12, SO100, SO100-400V3-50Hz-MARINE, SO100-440V3-60Hz-MARINE, SO120		

			
1			
GEV No.	512279	Ref. No.	34396
description	rinse pipe		
For models:	DP35, DP35D, DP40, DP40D, GS-X1021, GS-X1021-WEH, STS43, STS43D, STS48, STS48D, STS60, STS60D		

			
1			
GEV No.	512068	Ref. No.	25036
description	rinse arm support mounting pos. upper		
For models:	APS43, APS48, APS48B, APS53, APS60, APSE43, APSE48, APSE53, APSE60, C3, C35, C4, C43, C43D, C48, C48D, C53, C53D, C60, C60D, DP35, DP35D, DP40, DP40D, DP45, DP45D, DP50, DP50D, E40-2F, FW35, FW40, FW40B, FW45, FW50, INDY43F, INDY48F, INDY53F, INDY60F, SP45, SP45D, SP50, SP50-400V, SP50-440V, SP50D, STS43, STS43D, STS48, STS48D, STS53, STS53D...(Other models you can see in the webshop)		

			
1			
GEV No.	512280	Ref. No.	34397
description	rinse pipe		
For models:	60BT, 60BT-3, C53, C53D, C60, C60D, DP45, DP45D, DP50, DP50D, DP50D-115V, RSP50, RSP50A, SD5BT, SP45, SP45D, SP50, SP50-400V, SP50-440V, SP50D, STS43, STS43D, STS53, STS53D, STS60, STS60D, TN-TDN5, TN-TDN6, VS-X313, VS-X313-LP-DOS, VS-X515, VS-X515-LP-DOS		

			
1			
GEV No.	512197	Ref. No.	33729
description	rinse pipe mounting pos. lower ø 10/12mm L 270mm		
For models:	CA120, CA55, CA90, CAP7, CAP7E, ED550, ED650E, ED650S, RCA1100, RCA1200, RCA1200i, SO55, SO55-400V3-50Hz-MARINE, SO55-440V3-60Hz-MARINE, SO55E		

Зип Общепит

vsezip.ru

8(812)987-08-81

			
1			
GEV No.	524514	Ref. No.	33473
description	rinse pipe mounting pos. upper ø 12mm L 265mm		
For models:	CA120, CA55, CA90, CAP7, CAP7E, ED550, ED650E, ED650S, ICA1100, RCA1200, RCA1200i, SO55, SO55-400V3-50Hz-MARINE, SO55-410V3-60Hz-MARINE, SO55E, TS43		

			
1			
GEV No.	512241	Ref. No.	17920
description	screw		
For models:	APS43, APS48, APS48B, APS53, APS60, APSE43, APSE48, APSE53, APSE60, FW35, FW40, FW40B, FW45, FW50		

			
1			
GEV No.	511185	Ref. No.	261005
description	screw for wash arm support mounting pos. upper		
For models:	60EBT, AC101, AC151, AC181, AC201, AC241, AC91, C53DE, C53E, C6, C60DE, C60E, C68DE, C68E, C68EBT, C6D, C6DE, C6E, C6EBT, DP45DE, DP45E, DP50DE, DP50E, DP50EBT, EDT100, EDT140, EDT170, EDT200, EDT230, EDT85, SP45DE, SP45E, SP50DE, SP50E, ST53DE, ST53E, ST60DE, ST60E, ST60EBT		

			
1			
GEV No.	512322	Ref. No.	32234 35234
description	screw connection		
For models:	C3, C4, DP35-2, DP35D-2, DP40-2, DP40D-2, DP40D-rib2, DP40-rib2, GS-X1021-2, GS-X1021-2rib, GS-X1021-WEH-2, GS-X1021-WEH-2rib, ST43DE, ST43E, ST48DE, ST48E, ST48EBT, STS43-2, STS43D-2, STS48-2, STS48D-2, STS48D-rib2, STS48-rib2, TDN4-2rib		

			
1			
GEV No.	512069	Ref. No.	17933
description	screw connection for wash pipe		
For models:	APS43, APS48, APS48B, APS53, APS60, APSE43, APSE48, APSE53, APSE60, C3, C35, C4, C43, C43D, C48, C48D, C53, C53D, C60, C60D, DP35, DP35D, DP40, DP40D, DP45, DP45D, DP50, DP50D, FW35, FW40, FW40B, FW45, FW50, INDY43F, INDY48F, INDY53F, INDY60F, SP45, SP45D, SP50, SP50-400V, SP50-440V, SP50D, STS43, STS43D, STS48, STS48D, STS53, STS53D, STS60...(Other models you can see in the webshop)		

			
1			
GEV No.	512508	Ref. No.	36213
description	spacer ring ø 22mm ID ø 14mm H 14mm		
For models:	APS43, APS48, APS48B, APS53, APS60, FW35, FW40, FW40B, FW45, FW50		

			
1			
GEV No.	512043	Ref. No.	16575
description	throttle disc		
For models:	ED630-90, ED650E, ED650E-90, ED650S, ED650S-90		

			
1			
GEV No.	512239	Ref. No.	32358
description	wash arm bearing		
For models:	APS43, APS48, APS48B, APS53, APS60, APSE43, APSE48, APSE53, APSE60, FW35, FW40, FW40B, FW45, FW50		

			
1			
GEV No.	512307	Ref. No.	30483 35959
description	wash arm bearing		
For models:	E40-2F, ED600-95, ED700-90, ED900-90, EDI13, EDI13ALTA, EDI5, EDI6, EDI8, INDY43F, INDY48F, INDY53F, INDY60F, LO122, LO134, LO134ALTA, LO60, LO61, LO67, LO78, LO83, RLO200, RLO300, RLO400, TS43, TS48		

			
1			
GEV No.	512046	Ref. No.	30557
description	wash jet mounting pos. upper H 38mm ø 97mm		
For models:	DP35, DP35D, INDY43F, INDY48F, STS43, STS43D, TS48, UNI43C, UNI48C, UNI48CD		



washing and rinsing systems (sorted by product)

HOONVED



1

GEV No.	512005	Ref. No.	17976
description	wash arm		
For models:	C53, C60, DP45, DP45D, DP50, DP50D, INDY53F, INDY60F, STS43, STS43D, STS53, STS53D, STS60, STS60D, UNI53C, UNI60C		



1

GEV No.	518597	Ref. No.	H420553
description	wash arm		
For models:	C81, C81E, CA120, CA55, CA90, CAP10, CAP10BT, CAP12, CAP7, CAP7E, ED550, ED650E, ED650S, RCA1100, SO100, SO100-400V3-50Hz-MARINE, SO100-440V3-60Hz-MARINE, SO120, SO55, SO55E, SP81, SP81E		

spare parts for 518597

	GEV No.	509999	Ref. No.	—
	bush for rinse arm H 53mm ø 48.5mm SS			
	GEV No.	510236	Ref. No.	—
	plain washer ID ø 21mm ED ø 28mm thickness 1mm SS Qty 1 pcs			
	GEV No.	511241	Ref. No.	36011
	knurled nut thread M26x1 stainless steel ø 48.6mm H 10mm			



1

GEV No.	512300	Ref. No.	17974
description	wash arm L 385mm nozzles 7 mounting ø 22/49mm mounting pos. upper/lower		
For models:	C3, DP35, DP35D, DP40, DP40D, INDY43F, STS43, STS43D, STS48, STS48D, STS60, STS60D, UNI43C		

Зип Общепит

vsezip.ru

+7(812)987-08-81



GEV No.	512316	Ref. No.	35140
description	wash arm L 388mm nozzles 7 mounting ø 14/45.5mm mounting pos. lower		
For models:	DP35-2, DP35D-2, ST43DE, ST43E, STS43-2, STS43D-2		



1

GEV No.	512006	Ref. No.	17977
description	wash arm L 413mm nozzles 9 mounting ø 48.5mm mounting pos. lower		
For models:	INDY60F, UNI60C		



1

GEV No.	512004	Ref. No.	17975
description	wash arm L 415mm nozzles 9 mounting ø 32mm mounting pos. upper and bottom		
For models:	C4, C53, C53D, C60, C60D, DP40, DP40D, DP45, DP45D, GS-X1021, GS-X1021-WEH, INDY48F, INDY53F, SP45, SP45D, STS48, STS48D, STS53, STS53D, STS60, STS60D, UNI48C, UNI48CD, UNI53C		

accessories for 512004

	GEV No.	512050	Ref. No.	17972
	bush for wash arm			
	GEV No.	512053	Ref. No.	17971
	bush for wash arm			
	GEV No.	512062	Ref. No.	18703
	bush for wash arm			
	GEV No.	512275	Ref. No.	34262
	bush for wash arm			

Зип Общепит

vsezip.ru

+7(812)987-08-81



1

GEV No.	512317	Ref. No.	35141
description	wash arm L 417mm nozzles 9 mounting ø 14/45.5mm mounting pos. lower		
For models:	DP40-2, DP40D-2, DP40D-rib2, DP40-rib2, GS-X1021-2, GS-X1021-2rib, GS-X1021-WEH-2, GS-X1021-WEH-2rib, ST48DE, ST48E, ST48EBT, STS48-2, STS48D-2, STS48D-rib2, STS48-rib2, TDN4-2rib		



1

GEV No.	512002	Ref. No.	17085
description	wash arm L 540mm nozzles 10 mounting ø 60mm mounting pos. upper/lower		
For models:	C81, CA120, CA55, CA90, ED550, ED630-90, ED650E, ED650E-90, ED650S, ED650S-90, RCA1100, RCA1200, RCA1200i, SP81		



1

GEV No.	512007	Ref. No.	33586
description	wash arm L 480mm nozzles 8 mounting ø 48mm mounting pos. lower		
For models:	60BT, 60BT-3, C53, C53D, C60, C60D, DP45, DP45D, DP50, DP50D, DP50D-115V, RSP50, RSP50A, SD5BT, SP45, SP45D, SP50, SP50-400V, SP50-440V, SP50D, STS43, STS43D, STS48, STS48D, STS53, STS53D, STS60, STS60D, TN-TDN5, TN-TDN6, VS-X313, VS-X313-LP-DOS, VS-X515, VS-X515-LP-DOS		



1

GEV No.	512299	Ref. No.	21060
description	wash arm mounting pos. lower		
For models:	INDY53F		



1

GEV No.	510259	Ref. No.	H20548 H420548
description	wash arm L 505mm mounting pos. upper/lower nozzles 8 mounting ø 12/41mm		
For models:	60EBT, C53DE, C53E, C60DE, C60E, SP45DE, SP45E, SP50DE, SP50E, SP50E-400V3-50Hz-MARINE, SP50E-440V3-60Hz-MARINE, ST53DE, ST53E, ST60DE, ST60E		

spare parts for 510259



GEV No.	510313	Ref. No.	190617 H190617
----------------	--------	-----------------	-------------------

bush H 12mm D1 ø 20mm D2 ø 16mm D3 ø 12mm for wash arm boss



GEV No.	511007	Ref. No.	H191070
----------------	--------	-----------------	---------

bush for wash arm support



GEV No.	511231	Ref. No.	H191069
----------------	--------	-----------------	---------

wash arm bearing



1

GEV No.	511007	Ref. No.	H191070
description	bush for wash arm support		
For models:	60EBT, C53DE, C53E, C60DE, C60E, SP45DE, SP45E, SP50DE, SP50E, SP50E-400V3-50Hz-MARINE, SP50E-440V3-60Hz-MARINE, ST53DE, ST53E, ST60DE, ST60E		



1

GEV No.	510313	Ref. No.	190617 H190617
----------------	--------	-----------------	-------------------

bush H 12mm D1 ø 20mm D2 ø 16mm D3 ø 12mm for wash arm boss

For models: 60EBT, C53DE, C53E, C60DE, C60E, C68DE, C68E, CA120, CA55, CA90, DP45DE, DP45E, DP50DE, DP50E, DP50EBT, ED550, ED650E, ED650S, RCA1100, RCA1200, RCA1200i, SP45DE, SP45E, SP50DE, SP50E, SP50E-400V3-50Hz-MARINE, SP50E-440V3-60Hz-MARINE, SP68DE, SP68E, ST53DE, ST53E, ST60DE, ST60E, ST60EBT





Зип Общепит

vsezip.ru

+7(812)987-08-81

			
1			
GEV No.	512314	Ref. No.	35081
description	rinse arm L 340mm mounting ø 16mm nozzles 4		
For models:	DP35-2, DP35D-2, ST43DE, ST43E, STS43-2, STS43D-2		
spare parts for	512314		
	GEV No.	511237	Ref. No. 34360
	O-ring EPDM thickness 1mm ID ø 7mm Qty 1 pcs		
	GEV No.	511238	Ref. No. 34293
	opposite support for rinse jet		
	GEV No.	512210	Ref. No. 34997
	rinse arm shaft		
	GEV No.	512211	Ref. No. 34383
	bushing for rinse arm		
	GEV No.	512232	Ref. No. 34264
	rinse jet		





			
1			
GEV No.	512252	Ref. No.	34395 34395/R
description	rinse arm L 350mm mounting ø 16mm nozzles 4 mounting pos. upper		
For models:	C35, C43, C43D, C48, C48D, SP35, SP35D, SP40, SP40D		
spare parts for	512252		
	GEV No.	511237	Ref. No. 34360
	O-ring EPDM thickness 1mm ID ø 7mm Qty 1 pcs		
	GEV No.	511238	Ref. No. 34293
	opposite support for rinse jet		
	GEV No.	512211	Ref. No. 34383
	bushing for rinse arm		
	GEV No.	512232	Ref. No. 34264
	rinse jet		

			
1			
GEV No.	512270	Ref. No.	34385
description	rinse arm L 340mm mounting ø 16mm nozzles 42 mounting pos. lower		
For models:	C35, C43, C43D, C48, C48D, DP35, DP35D, SP35, SP35D, SP40, SP40D, SPB35, STS43, STS43D		
spare parts for	512270		
	GEV No.	511237	Ref. No. 34360
	O-ring EPDM thickness 1mm ID ø 7mm Qty 1 pcs		
	GEV No.	511238	Ref. No. 34293
	opposite support for rinse jet		
	GEV No.	512211	Ref. No. 34383
	bushing for rinse arm		
	GEV No.	512232	Ref. No. 34264
	rinse jet		
	GEV No.	512257	Ref. No. 34382
	knurled nut thread M10L ø 30mm H 6.5mm SS		

			
1			
GEV No.	512202	Ref. No.	36245
description	rinse arm L 415mm mounting ø 12mm nozzles 5 mounting pos. upper		





			
1			
GEV No.	512271	Ref. No.	34386
description	rinse arm L 417mm mounting ø 16mm nozzles 5 mounting pos. upper		
For models:	DP40, DP40D, DP45, DP45D, DP50, DP50D, GS-X1021, GS-X1021-WEH, STS48, STS48D, STS53, STS53D, STS60, STS60D		
spare parts for	512271		
	GEV No.	511237	Ref. No. 34360
	O-ring EPDM thickness 1mm ID ø 7mm Qty 1 pcs		
	GEV No.	511238	Ref. No. 34293
	opposite support for rinse jet		

Table continues overleaf

spare parts for		512271		
	GEV No.	512018	Ref. No.	34384
rinse arm shaft mounting pos. upper/lower ø 16mm thread M10L L 38mm				
	GEV No.	512211	Ref. No.	34383
bushing for rinse arm				
	GEV No.	512232	Ref. No.	34264
rinse jet				
	GEV No.	512257	Ref. No.	34382
knurled nut thread M10L ø 30mm H 6.5mm SS				



1

GEV No.	512315	Ref. No.	35082	
description	rinse arm L 418mm mounting ø 16mm nozzles 5 mounting pos. upper/lower			
For models:	DP40-2, DP40D-2, DP40D-rib2, DP40-rib2, GS-X1021-2, GS-X1021-2rib, GS-X1021-WEH-2, GS-X1021-WEH-2rib, ST48DE, ST48E, ST48EBT, STS48-2, STS48D-2, STS48D-rib2, STS48-rib2, TDN4-2rib			
spare parts for 512315				
	GEV No.	511237	Ref. No.	34360
O-ring EPDM thickness 1mm ID ø 7mm Qty 1 pcs				
	GEV No.	511238	Ref. No.	34293
opposite support for rinse jet				
	GEV No.	512210	Ref. No.	34997
rinse arm shaft				
	GEV No.	512211	Ref. No.	34383
bushing for rinse arm				
	GEV No.	512232	Ref. No.	34264
rinse jet				







1

GEV No.	512272	Ref. No.	34387	
description	rinse arm L 484mm mounting ø 16mm nozzles 6 mounting pos. upper/lower			
For models:	60BT, 60BT-3, C53, C53D, C60, C60D, DP45, DP45D, DP50, DP50D, DP50D-115V, RSP50, RSP50A, SD5BT, SP45, SP45D, SP50, SP50-400V, SP50-440V, SP50D, STS53, STS53D, STS60, STS60D, TN-TDN5, TN-TDN6, VS-X313, VS-X313-LP-DOS, VS-X515, VS-X515-LP-DOS			
spare parts for 512272				
	GEV No.	511237	Ref. No.	34360
O-ring EPDM thickness 1mm ID ø 7mm Qty 1 pcs				

Зип-Общепит







vsezip.ru

+7(812)987-08-81

spare parts for		512272		
	GEV No.	511238	Ref. No.	34293
opposite support for rinse jet				
	GEV No.	512018	Ref. No.	34384
rinse arm shaft mounting pos. upper/lower ø 16mm thread M10L L 38mm				
	GEV No.	512211	Ref. No.	34383
bushing for rinse arm				
	GEV No.	512232	Ref. No.	34264
rinse jet				
	GEV No.	512257	Ref. No.	34382
knurled nut thread M10L ø 30mm H 6.5mm SS				











1

GEV No.	512188	Ref. No.	430344 H430344	
description	rinse arm L 500mm mounting ø 16mm nozzles 6 mounting pos. upper/lower stainless steel			
For models:	CAP10, CAP10BT, CAP10DE, CAP7, CAP7E, SO100, SO100-400V3-50Hz-MARINE, SO100-440V3-60Hz-MARINE, SO55, SO55E			
spare parts for 512188				
	GEV No.	510307	Ref. No.	261009 H261009
Thumb screw thread M6 H 3mm thread L 8mm ø 28mm SS				
	GEV No.	511237	Ref. No.	34360
O-ring EPDM thickness 1mm ID ø 7mm Qty 1 pcs				
	GEV No.	511238	Ref. No.	34293
opposite support for rinse jet				
	GEV No.	511242	Ref. No.	H450218
connector holder L 30mm H 16mm W 22mm				
	GEV No.	512232	Ref. No.	34264
rinse jet				
	GEV No.	512262	Ref. No.	H190641
bush for rinse arm				











Зип-Общепит
vsezip.ru
+7(812)987-08-81

			
1			
GEV No.	512479	Ref. No.	36409 36410
description	rinse arm L 500mm mounting pos. upper/lower nozzles 6 for model C53/60 E		
For models:	60EBT, C53DE, C53E, C60DE, C60E, DP45DE, DP45E, DP50DE, DP50E, DP50EBT, SP45DE, SP45E, SP50DE, SP50E, SP50E-400V3-50Hz-MARINE, SP50E-440V3-60Hz-MARINE, ST53DE, ST53E, ST60DE, ST60E, ST60EBT		
accessories for	512479		
	GEV No.	511237	Ref. No. 34360
	O-ring EPDM thickness 1mm ID ø 7mm Qty 1 pcs		
	GEV No.	511238	Ref. No. 34293
	opposite support for rinse jet		
	GEV No.	512211	Ref. No. 34383
	bushing for rinse arm		
	GEV No.	512212	Ref. No. 34998
	knurled nut thread M10x1.5 ø 30mm H 6.4mm SS		
	GEV No.	512232	Ref. No. 34264
	rinse jet		

spare parts for 512209			
	GEV No.	512212	Ref. No. 34998
	knurled nut thread M10x1.5 ø 30mm H 6.4mm SS		
	GEV No.	560140	Ref. No. 30194
	hexagonal nut thread M4 H 4.8mm SS WS 7 Qty 20 pcs DIN/ISO DIN 985 self-locking		

			
1			
GEV No.	512186	Ref. No.	36237
description	wash arm L 335mm nozzles 4 mounting ø 15/26mm mounting pos. lower		

			
1			
GEV No.	512187	Ref. No.	36238
description	wash arm mounting pos. lower L 393mm nozzles 5 stainless steel		

			
1			
GEV No.	512209	Ref. No.	35404
description	rinse arm L 530mm mounting pos. upper/lower nozzles 6 mounting ø 16mm		
spare parts for	512209		
	GEV No.	510303	Ref. No. 31014 456030 H200818
	O-ring EPDM thickness 1.78mm ID ø 6.75mm Qty 1 pcs		
	GEV No.	510309	Ref. No. 170911 H170911
	nozzle for rinse arm mounting pos. right/left		
	GEV No.	510310	Ref. No. 170704 H170704
	opposite support for rinse jet		
	GEV No.	511004	Ref. No. H260226
	flat-headed bolt thread M4 thread L 12mm SS DIN 84/ISO 1207 Qty 1 pcs intake slotted L 14.5mm		
	GEV No.	512210	Ref. No. 34997
	rinse arm shaft		
	GEV No.	512211	Ref. No. 34383
	bushing for rinse arm		

			
1			
GEV No.	511242	Ref. No.	H450218
description	connector holder L 30mm H 16mm W 22mm		
For models:	C90DE2, C90E2, C90EBT2, C98, CA120, CA90, CAP10, CAP10BT, CAP12, CAP7, CAP7E, ED650E, ED650S, EDI13-2, EDI13ALTA-2, EDI13ALTABT, EDI13BT, EDI4, EDI6-2, EDI6BT, EDI8-2, EDI8BT, LO134-2, LO134ALTA-2, LO56, LO62, LO67-2, LO83-2, RCA1100, RCA1200, RCA1200i, SO100, SO100-400V3-50Hz-MARINE, SO100-440V3-60Hz-MARINE, SO120, SO55, SO55E		

			
1			
GEV No.	511238	Ref. No.	34293
description	opposite support for rinse jet		



			
1			
GEV No.	512320	Ref. No.	34293
description	opposite support for rinse jet		
For models:	60BT, 60BT-3, 60EBT, AP43E, AP48E, AP53E, AP60E, APS43, APS48, APS48B, APS53, APS60, C35, C43, C43D, C48, C48D, C53, C53D, C53DE, C53E, C60, C60D, C60DE, C60E, C68DE, C68E, C68EBT, C81, C90, CAP10, CAP10BT, CAP10DE, CAP7, CAP7E, DP35, DP35-2, DP35D, DP35D-2, DP40, DP40-2, DP40D, DP40D-2, DP40D-rib2, DP40-rib2, DP45, DP45D, DP45DE, DP45E, DP50...(Other models you can see in the webshop)		



1				
GEV No.	511237	Ref. No.	34360	
description	O-ring EPDM thickness 1mm ID ø 7mm Qty 1 pcs			
For models:	60BT, 60BT-3, 60EBT, AP43E, AP48E, AP53E, AP60E, APS43, APS48, APS48B, APS53, APS60, C35, C43, C43D, C48, C48D, C53, C53D, C53DE, C53E, C60, C60D, C60DE, C60E, C68DE, C68E, C68EBT, C81, C90, CAP10, CAP10BT, CAP10DE, CAP7, CAP7E, DP35, DP35-2, DP35D, DP35D-2, DP40, DP40-2, DP40D, DP40D-2, DP40D-rib2, DP40-rib2, DP45, DP45D, DP45DE, DP45E, DP50...(Other models you can see in the webshop)			

1				
GEV No.	512232	Ref. No.	34264	
description	rinse jet			
For models:	60BT, 60BT-3, 60EBT, AP43E, AP48E, AP53E, AP60E, APS43, APS48, APS48B, APS53, APS60, C35, C43, C43D, C48, C48D, C53, C53D, C53DE, C53E, C60, C60D, C60DE, C60E, C68DE, C68E, C68EBT, C81, C90, CAP10, CAP10BT, CAP10DE, CAP7, CAP7E, DP35, DP35-2, DP35D, DP35D-2, DP40, DP40-2, DP40D, DP40D-2, DP40D-rib2, DP40-rib2, DP45, DP45D, DP45DE, DP45E, DP50...(Other models you can see in the webshop)			

1				
GEV No.	510307	Ref. No.	261009 H261009	
description	Thumb screw thread M6 H 3mm thread L 8mm ø 28mm SS			
For models:	C35, C35E, C43, C43-2, C43ALTA, C43D, C43DE, C43E, C46DE, C46E, C48, C48-2, C48D, C48D-2, C48DDL, C48DL, C48E, C6, C68DE, C68E, C68EBT, C6D, C6DE, C6E, C6EBT, C90DE2, C90E2, C90EBT2, C98, CA120, CA55, CA90, CAP10, CAP10BT, CAP10DE, CAP12, CAP12DE, CAP12EBT, CAP15EBT, CAP7, CAP7E, ED550, ED650E, ED650S, EDI13-2, EDI13ALTA-2, EDI13ALTABT, EDI13BT, EDI4, EDI6-2...(Other models you can see in the webshop)			

1				
GEV No.	517625	Ref. No.	34263	
description	wash jet H 16mm ø 12mm			
For models:	APS43, APS48, APS48B, APS53, APS60, FW35, FW40, FW40B, FW45, FW50			

1				
GEV No.	512325	Ref. No.	33892 430316	
description	rinse arm L 490mm mounting ø 12mm nozzles 6 mounting pos. upper/lower			
For models:	CA120, CAP12, CAP12DE, CAP12EBT, CAP15EBT, ED650E, ED650S, RCA1100, RCA1200, RCA1200i, SO120			
spare parts for	512325			
	GEV No.	510307	Ref. No.	261009 H261009
		Thumb screw thread M6 H 3mm thread L 8mm ø 28mm SS		

spare parts for	512325			
	GEV No.	510369	Ref. No.	H380314
		nozzle for rinse arm		
	GEV No.	511242	Ref. No.	H450218
		connector holder L 30mm H 16mm W 22mm		
	GEV No.	512262	Ref. No.	H190641
		bush for rinse arm		

1				
GEV No.	511242	Ref. No.	H450218	
description	connector holder L 30mm H 16mm W 22mm			
For models:	C90DE2, C90E2, C90EBT2, C98, CA120, CA90, CAP10, CAP10BT, CAP12, CAP7, CAP7E, ED650E, ED650S, EDI13-2, EDI13ALTA-2, EDI13ALTABT, EDI13BT, EDI4, EDI6-2, EDI6BT, EDI8-2, EDI8BT, LO134-2, LO134ALTA-2, LO56, LO62, LO67-2, LO83-2, RCA1100, RCA1200, RCA1200i, SO100, SO100-400V3-50Hz-MARINE, SO100-440V3-60Hz-MARINE, SO120, SO55, SO55E			

1				
GEV No.	510369	Ref. No.	H380314	
description	nozzle for rinse arm			
For models:	CA120, CA90, CAP12, ED650E, ED650S, RCA1100, RCA1200, RCA1200i, SO120			

1				
GEV No.	510307	Ref. No.	261009 H261009	
description	Thumb screw thread M6 H 3mm thread L 8mm ø 28mm SS			
For models:	C35, C35E, C43, C43-2, C43ALTA, C43D, C43DE, C43E, C46DE, C46E, C48, C48-2, C48D, C48D-2, C48DDL, C48DL, C48E, C6, C68DE, C68E, C68EBT, C6D, C6DE, C6E, C6EBT, C90DE2, C90E2, C90EBT2, C98, CA120, CA55, CA90, CAP10, CAP10BT, CAP10DE, CAP12, CAP12DE, CAP12EBT, CAP15EBT, CAP7, CAP7E, ED550, ED650E, ED650S, EDI13-2, EDI13ALTA-2, EDI13ALTABT, EDI13BT, EDI4, EDI6-2...(Other models you can see in the webshop)			



1				
GEV No.	512008	Ref. No.	33957	
description	wash and rinse arm 2 wash arms/ 2 rinse arms			
For models:	C35, C43, C43ALTA, C43D, C48, C48D, C48DDL, C48DL, GS-X1011, GS-X1011-WEH, SP35, SP35ALTA, SP35D, SP40, SP40D, SP40DDL, SP40DL, SPB35			
spare parts for	512008			
	GEV No.	510307	Ref. No.	261009 H261009
		Thumb screw thread M6 H 3mm thread L 8mm ø 28mm SS		
	GEV No.	510321	Ref. No.	160736 H160736
		end cap for wash arm		

Table continues overleaf







spare parts for		512008	
	GEV No.	510322	Ref. No. 27050
O-ring EPDM thickness 1.78mm ID ø 17.17mm Qty 1 pcs			
	GEV No.	510323	Ref. No. 160734 33793
end cap for rinse arm			
	GEV No.	510325	Ref. No. 170956 H170956
nozzle for wash arm			
	GEV No.	510327	Ref. No. 170946 33791 H170946
nozzle for rinse arm			
	GEV No.	510329	Ref. No. 190624 190649 H190624 H190649
bush H 13.5mm D1 ø 20mm D2 ø 16mm D3 ø 12mm for wash arm			
	GEV No.	510901	Ref. No. H200843
O-ring EPDM thickness 2mm ID ø 13mm Qty 1 pcs			
	GEV No.	510902	Ref. No. 33790
O-ring EPDM thickness 2mm ID ø 9.5mm Qty 1 pcs			
	GEV No.	512265	Ref. No. 140106 H140108
connector holder			
	GEV No.	528583	Ref. No. 33792
O-ring EPDM thickness 2.62mm ID ø 9.13mm Qty 1 pcs			

1			
GEV No.	512264	Ref. No.	H420531
description	wash and rinse arm wash arm L 410mm rinse arm L 410mm mounting pos. lower w. jets 6 r. jets 4 mounting ø 12/45mm 2 wash arms/ 2 rinse arms		
For models:	C35, C35E, C43-2, C43DE, C43E, C46DE, C46E, C48-2, C48D-2, C48E, GS-X1011-2, GS-X1011-WEH-2, RSP40, RSP40A, SP35-2, SP35DE, SP35E, SP40-2, SP40D-2, SP40DE, SP40E, SPB35, SPB35E		
spare parts for	512264		
	GEV No.	510307	Ref. No. 261009 H261009
Thumb screw thread M6 H 3mm thread L 8mm ø 28mm SS			
	GEV No.	510321	Ref. No. 160736 H160736
end cap for wash arm			
	GEV No.	510322	Ref. No. 27050
O-ring EPDM thickness 1.78mm ID ø 17.17mm Qty 1 pcs			
	GEV No.	510323	Ref. No. 160734 33793
end cap for rinse arm			
	GEV No.	510325	Ref. No. 170956 H170956
nozzle for wash arm			
	GEV No.	510327	Ref. No. 170946 33791 H170946
nozzle for rinse arm			
	GEV No.	510329	Ref. No. 190624 190649 H190624 H190649
bush H 13.5mm D1 ø 20mm D2 ø 16mm D3 ø 12mm for wash arm			

spare parts for		512264	
	GEV No.	510327	Ref. No. 170946 33791 H170946
Thumb screw thread M6 H 3mm thread L 8mm ø 28mm SS			
nozzle for rinse arm			
	GEV No.	510325	Ref. No. 190624 190649 H190624 H190649
nozzle for wash arm			
	GEV No.	510901	Ref. No. H200843
bush H 13.5mm D1 ø 20mm D2 ø 16mm D3 ø 12mm for wash arm			
	GEV No.	510902	Ref. No. 33790
O-ring EPDM thickness 2mm ID ø 9.5mm Qty 1 pcs			
	GEV No.	512265	Ref. No. 140106 H140108
connector holder			
	GEV No.	528583	Ref. No. 33792
O-ring EPDM thickness 2.62mm ID ø 9.13mm Qty 1 pcs			

1			
GEV No.	512385	Ref. No.	33968 H420551
description	wash and rinse arm wash arm L 410mm rinse arm L 410mm mounting pos. upper w. jets 6 r. jets 4 mounting ø 12/45mm		
For models:	C35E, C43-2, C43ALTA, C43DE, C43E, C46DE, C46E, C48-2, C48D-2, C48DDL, C48DL, C48E, GS-X1011, GS-X1011-2, GS-X1011-WEH, GS-X1011-WEH-2, RSP40, RSP40A, SP35-2, SP35ALTA, SP35DE, SP35E, SP40-2, SP40D-2, SP40DDL, SP40DE, SP40DL, SP40E, SPB35E		
spare parts for	512385		
	GEV No.	510307	Ref. No. 261009 H261009
Thumb screw thread M6 H 3mm thread L 8mm ø 28mm SS			
	GEV No.	510322	Ref. No. 27050
O-ring EPDM thickness 1.78mm ID ø 17.17mm Qty 1 pcs			
	GEV No.	510323	Ref. No. 160734 33793
end cap for rinse arm			
	GEV No.	510325	Ref. No. 170956 H170956
nozzle for wash arm			
	GEV No.	510327	Ref. No. 170946 33791 H170946
nozzle for rinse arm			
	GEV No.	510329	Ref. No. 190624 190649 H190624 H190649
bush H 13.5mm D1 ø 20mm D2 ø 16mm D3 ø 12mm for wash arm			

Table continues overleaf

spare parts for 512385			
	GEV No.	510901	Ref. No. H200843
O-ring EPDM thickness 2mm ID ø 13mm Qty 1 pcs			
	GEV No.	510902	Ref. No. 33790
O-ring EPDM thickness 2mm ID ø 9.5mm Qty 1 pcs			
	GEV No.	512265	Ref. No. 140106 H140108
connector holder			
	GEV No.	528583	Ref. No. 33792
O-ring EPDM thickness 2.62mm ID ø 9.13mm Qty 1 pcs			



GEV No.	510275	Ref. No.	420526 H420526
description	wash and rinse arm wash arm L 505mm rinse arm L 505mm mounting pos. upper/lower w. jets 8 r. jets 5 mounting ø 12/45mm		
For models:	C6, C6D, C6DE, C6E, C6EBT, SP5, SP5D, SP5DE, SP5E		

spare parts for 510275			
	GEV No.	510307	Ref. No. 261009 H261009
Thumb screw thread M6 H 3mm thread L 8mm ø 28mm SS			
	GEV No.	510321	Ref. No. 160736 H160736
end cap for wash arm			
	GEV No.	510322	Ref. No. 27050
O-ring EPDM thickness 1.78mm ID ø 17.17mm Qty 1 pcs			
	GEV No.	510323	Ref. No. 160734 33793
end cap for rinse arm			
	GEV No.	510325	Ref. No. 170956 H170956
nozzle for wash arm			
	GEV No.	510327	Ref. No. 170946 33791 H170946
nozzle for rinse arm			
	GEV No.	510329	Ref. No. 190624 190649 H190624 H190649
bush H 13.5mm D1 ø 20mm D2 ø 16mm D3 ø 12mm for wash arm			
	GEV No.	510902	Ref. No. 33790
O-ring EPDM thickness 2mm ID ø 9.5mm Qty 1 pcs			
	GEV No.	512265	Ref. No. 140106 H140108
connector holder			
	GEV No.	528583	Ref. No. 33792
O-ring EPDM thickness 2.62mm ID ø 9.13mm Qty 1 pcs			

Зип Общепит

vsezip.ru

+7(812)987-08-81

	GEV No.	510329	Ref. No.	190624 190649 H190624 H190649
description	bush H 13.5mm D1 ø 20mm D2 ø 16mm D3 ø 12mm for wash arm			
For models:	C35, C35E, C43, C43-2, C43ALTA, C43D, C43DE, C43E, C46DE, C46E, C48, C48-2, C48D, C48D-2, C48DDL, C48DL, C48E, C6, C6D, C6DE, C6E, C6EBT, GS-X1011, GS-X1011-2, GS-X1011-WEH, GS-X1011-WEH-2, RSP40, RSP40A, SP35, SP35-2, SP35ALTA, SP35D, SP35DE, SP35E, SP40, SP40-2, SP40D, SP40D-2, SP40DDL, SP40DE, SP40DL, SP40E, SP5, SP5D, SP5DE, SP5E, SPB35, SPB35E			

	GEV No.	512265	Ref. No.	140106 H140108
description	connector holder			
For models:	C35, C35E, C43, C43-2, C43ALTA, C43D, C43DE, C43E, C46DE, C46E, C48, C48-2, C48D, C48D-2, C48DDL, C48DL, C6, C68DE, C68E, C6D, C6DE, C6E, CA120, CA55, CA90, ED550, ED650E, ED650S, RCA1100, RCA1200, RCA1200i, RSP40, RSP40A, SP35, SP35-2, SP35ALTA, SP35D, SP35DE, SP35E, SP40, SP40-2, SP40D, SP40D-2, SP40DDL, SP40DE, SP40DL, SP40E, SP5, SP5D, SP5DE... (Other models you can see in the webshop)			

	GEV No.	510323	Ref. No.	160734 33793
description	end cap for rinse arm			
For models:	C35, C35E, C43, C43-2, C43ALTA, C43D, C43DE, C43E, C46DE, C46E, C48, C48-2, C48D, C48D-2, C48DDL, C48DL, C48E, C6, C6D, C6DE, C6E, C6EBT, CDN3, CDN4, CR43, CR43D, CR48, CR48D, GS-X1011, GS-X1011-2, GS-X1011-WEH, GS-X1011-WEH-2, RSP40, RSP40A, SP35, SP35-2, SP35ALTA, SP35D, SP35DE, SP35E, SP40, SP40-2, SP40D, SP40D-2, SP40DDL, SP40DE, SP40DL, SP40E, SP5, SP5D... (Other models you can see in the webshop)			



	GEV No.	510321	Ref. No.	160736 H160736
description	end cap for wash arm			
For models:	C35, C35E, C43, C43-2, C43ALTA, C43D, C43DE, C43E, C46DE, C46E, C48, C48-2, C48D, C48D-2, C48DDL, C48DL, C48E, C6, C6D, C6DE, C6E, C6EBT, GS-X1011, GS-X1011-2, GS-X1011-WEH, GS-X1011-WEH-2, RSP40, RSP40A, SP35, SP35-2, SP35ALTA, SP35D, SP35DE, SP35E, SP40, SP40-2, SP40D, SP40D-2, SP40DDL, SP40DE, SP40DL, SP40E, SP5, SP5D, SP5DE, SP5E, SPB35, SPB35E			





Зип Общепит

vsezip.ru

+7(812)9813131

			
GEV No.	510327	Ref. No.	170946 33791 H170946
description	nozzle for rinse arm		
For models:	C35, C35E, C43, C43-2, C43ALTA, C43D, C43DE, C43E, C46DE, C46E, C48, C48-2, C48D, C48D-2, C48DDL, C48DL, C48E, C6, C6D, C6DE, C6E, C6EBT, CDN3, CDN4, CR43, CR43D, CR48, CR48D, GS-X1011, GS-X1011-2, GS-X1011-WEH, GS-X1011-WEH-2, RSP40, RSP40A, SP35, SP35-2, SP35ALTA, SP35D, SP35DE, SP35E, SP40, SP40-2, SP40D, SP40D-2, SP40DDL, SP40DE, SP40DL, SP40E, SP5, SP5D...(Other models you can see in the webshop)		
accessories for	510327		
			
GEV No.	510902	Ref. No.	33790
description	O-ring EPDM thickness 2mm ID ø 9.5mm Qty 1 pcs		

			
GEV No.	510325	Ref. No.	170956 H170956
description	nozzle for wash arm		
For models:	C35, C35E, C43, C43-2, C43ALTA, C43D, C43DE, C43E, C46DE, C46E, C48, C48-2, C48D, C48D-2, C48DDL, C48DL, C48E, C6, C6D, C6DE, C6E, C6EBT, GS-X1011, GS-X1011-2, GS-X1011-WEH, GS-X1011-WEH-2, RSP40, RSP40A, SP35, SP35-2, SP35ALTA, SP35D, SP35DE, SP35E, SP40, SP40-2, SP40D, SP40D-2, SP40DDL, SP40DE, SP40DL, SP40E, SP5, SP5D, SP5DE, SP5E, SPB35, SPB35E		

			
GEV No.	510322	Ref. No.	27050
description	O-ring EPDM thickness 1.78mm ID ø 17.17mm Qty 1 pcs		
For models:	C35, C35E, C43, C43-2, C43ALTA, C43D, C43DE, C43E, C46DE, C46E, C48, C48-2, C48D, C48D-2, C48DDL, C48DL, C48E, C6, C6D, C6DE, C6E, C6EBT, E40-2F, ED600-95, ED700-90, ED900-90, EDI5, GS-X1011, GS-X1011-2, GS-X1011-WEH, GS-X1011-WEH-2, INDY43F, INDY48F, INDY53F, INDY60F, K80F, LO122, LO60, LO61, LO78, RSP40, RSP40A, SP35, SP35-2, SP35ALTA, SP35D, SP35DE, SP35E, SP40, SP40-2...(Other models you can see in the webshop)		

			
GEV No.	528583	Ref. No.	33792
description	O-ring EPDM thickness 2.62mm ID ø 9.13mm Qty 1 pcs		
For models:	C35, C35E, C43, C43-2, C43ALTA, C43D, C43DE, C43E, C46DE, C46E, C48, C48-2, C48D, C48D-2, C48DDL, C48DL, C48E, C6, C6D, C6DE, C6E, C6EBT, CDN3, CDN4, CR43, CR43D, CR48, CR48D, GS-X1011, GS-X1011-2, GS-X1011-WEH, GS-X1011-WEH-2, RSP40, RSP40A, SP35, SP35-2, SP35ALTA, SP35D, SP35DE, SP35E, SP40, SP40-2, SP40D, SP40D-2, SP40DDL, SP40DE, SP40DL, SP40E, SP5, SP5D...(Other models you can see in the webshop)		

			
GEV No.	510901	Ref. No.	H200843
description	O-ring EPDM thickness 2mm ID ø 13mm Qty 1 pcs		
For models:	C35, C35E, C43, C43-2, C43ALTA, C43D, C43DE, C43E, C46DE, C46E, C48, C48-2, C48D, C48D-2, C48DDL, C48DL, C48E, C6, C6D, C6DE, C6E, GS-X1011, GS-X1011-2, GS-X1011-WEH, GS-X1011-WEH-2, RSP40, RSP40A, SP35, SP35-2, SP35ALTA, SP35D, SP35DE, SP35E, SP40, SP40-2, SP40D, SP40D-2, SP40DDL, SP40DE, SP40DL, SP40E, SP5, SP5D, SP5DE, SP5E, SPB35, SPB35E		

			
GEV No.	510902	Ref. No.	33790
description	O-ring EPDM thickness 2mm ID ø 9.5mm Qty 1 pcs		
For models:	C35, C35E, C43, C43-2, C43ALTA, C43D, C43DE, C43E, C46DE, C46E, C48, C48-2, C48D, C48D-2, C48DDL, C48DL, C48E, C6, C6D, C6DE, C6E, C6EBT, C6D, C6DE, C6E, C6EBT, C90, C90DE, C90E, C90EBT, CDN3, CDN4, CR43, CR43D, CR48, CR48D, EDI13, EDI13ALTA, EDI6, EDI8, GS-X1011, GS-X1011-2, GS-X1011-WEH, GS-X1011-WEH-2, LO134, LO134ALTA, LO50, LO50E, LO67, LO83, RLO200...(Other models you can see in the webshop)		

			
GEV No.	510307	Ref. No.	261009 H261009
description	Thumb screw thread M6 H 3mm thread L 8mm ø 28mm SS		
For models:	C35, C35E, C43, C43-2, C43ALTA, C43D, C43DE, C43E, C46DE, C46E, C48, C48-2, C48D, C48D-2, C48DDL, C48DL, C48E, C6, C6D, C6DE, C6E, C6EBT, C6D, C6DE, C6E, C6EBT, C90DE2, C90E2, C90EBT2, C98, CA120, CA55, CA90, CAP10, CAP10BT, CAP10DE, CAP12, CAP12DE, CAP12EBT, CAP15EBT, CAP7, CAP7E, ED550, ED650E, ED650S, EDI13-2, EDI13ALTA-2, EDI13ALTABT, EDI13BT, EDI4, EDI6-2...(Other models you can see in the webshop)		

			
GEV No.	510747	Ref. No.	H420545
description	wash and rinse arm wash arm L 410mm rinse arm L 410mm mounting pos. lower w. jets 6 r. jets 4 mounting ø 12/45mm nozzle type C		
spare parts for	510747		
			
GEV No.	510300	Ref. No.	—
description	end cap for wash arm		
			
GEV No.	510302	Ref. No.	29670 H200823 H200824
description	O-ring EPDM ID ø 12.42mm thickness 1.78mm Qty 1 pcs		
			
GEV No.	510303	Ref. No.	31014 456030 H200818
description	O-ring EPDM thickness 1.78mm ID ø 6.75mm Qty 1 pcs		
			
GEV No.	510305	Ref. No.	H180213
description	opposite support for wash jet		
			
GEV No.	510307	Ref. No.	261009 H261009
description	Thumb screw thread M6 H 3mm thread L 8mm ø 28mm SS		
			
GEV No.	510309	Ref. No.	170911 H170911
description	nozzle for rinse arm mounting pos. right/left		
			
GEV No.	510310	Ref. No.	170704 H170704
description	opposite support for rinse jet		
			
GEV No.	510313	Ref. No.	190617 H190617
description	bush H 12mm D1 ø 20mm D2 ø 16mm D3 ø 12mm for wash arm boss		

Table continues overleaf

spare parts for		510747		
	GEV No.	510315	Ref. No.	170929 H170929
nozzle for rinse arm mounting pos. centre/inside				
	GEV No.	510316	Ref. No.	—
blank nozzle mounting pos. centre for wash arm				
	GEV No.	510317	Ref. No.	170930 H170930
blank nozzle mounting pos. centre for rinse arm				
	GEV No.	510752	Ref. No.	—
wash jet mounting pos. right				
	GEV No.	510753	Ref. No.	—
wash jet mounting pos. left				
	GEV No.	510871	Ref. No.	H191022
wash arm boss				
	GEV No.	512265	Ref. No.	140106 H140108
connector holder				
	GEV No.	560140	Ref. No.	30194
hexagonal nut thread M4 H 4.8mm SS W5 7 Qty 20 pcs DIN/ISO DIN 985 self-locking				

	GEV No.	510317	Ref. No.	170930 H170930
description blank nozzle mounting pos. centre for rinse arm				
For models: C68DE, C68E, CA120, CA55, CA90, ED550, ED650E, ED650S, RCA1100, RCA1200, RCA1200i, SP68DE, SP68E				

	GEV No.	510313	Ref. No.	190617 H190617
description bush H 12mm D1 ø 20mm D2 ø 16mm D3 ø 12mm for wash arm boss				
For models: 60EBT, C53DE, C53E, C60DE, C60E, C68DE, C68E, CA120, CA55, CA90, DP45DE, DP45E, DP50DE, DP50E, DP50EBT, ED550, ED650E, ED650S, RCA1100, RCA1200, RCA1200i, SP45DE, SP45E, SP50DE, SP50E, SP50E-400V3-50Hz-MARINE, SP50E-440V3-60Hz-MARINE, SP68DE, SP68E, ST53DE, ST53E, ST60DE, ST60E, ST60EBT				

	GEV No.	512265	Ref. No.	140106 H140108
description connector holder				
For models: C35, C35E, C43, C43-2, C43ALTA, C43D, C43DE, C43E, C46DE, C46E, C48, C48-2, C48D, C48D-2, C48DDL, C48DL, C6, C68DE, C68E, C6D, C6DE, C6E, CA120, CA55, CA90, ED550, ED650E, ED650S, RCA1100, RCA1200, RCA1200i, RSP40, RSP40A, SP35, SP35-2, SP35ALTA, SP35D, SP35DE, SP35E, SP40, SP40-2, SP40D, SP40D-2, SP40DDL, SP40DE, SP40DL, SP40E, SP5, SP5D, SP5DE...(Other models you can see in the webshop)				

Зип Общепит

	GEV No.	510315	Ref. No.	170929 H170929
description nozzle for rinse arm mounting pos. centre/inside				
For models: C68DE, C68E, CA120, CA55, CA90, ED550, ED650E, ED650S, RCA1100, RCA1200, RCA1200i, SP68DE, SP68E				

	GEV No.	510309	Ref. No.	170911 H170911
description nozzle for rinse arm mounting pos. right/left				
For models: C68DE, C68E, C81E, C81EBT, C90, C90DE, C90DE2, C90E, C90E2, C90EBT, C90EBT2, C98, CA120, CA55, CA90, ED550, ED650E, ED650S, LO50, LO50E, LO62, RCA1100, RCA1200, RCA1200i, RLO50, SMW15, SMW15E, SP68DE, SP68E, SP81E, US-X501				

	GEV No.	510310	Ref. No.	170704 H170704
description opposite support for rinse jet				
For models: C68DE, C68E, C81E, C81EBT, C90, C90DE, C90DE2, C90E, C90E2, C90EBT, C90EBT2, C98, CA120, CA55, CA90, ED550, ED650E, ED650S, LO50, LO50E, LO62, RCA1100, RCA1200, RCA1200i, RLO50, SMW15, SMW15E, SP68DE, SP68E, SP81E, US-X501				

	GEV No.	510305	Ref. No.	H180213
description opposite support for wash jet				

	GEV No.	510302	Ref. No.	29670 H200823 H200824
description O-ring EPDM ID ø 12.42mm thickness 1.78mm Qty 1 pcs				
For models: AP43E, AP48E, AP53E, AP60E, APS43, APS48, APS48B, APS53, APS60, APSE43, APSE48, APSE53, APSE60, BPS43, BPS52, C68DE, C68E, E40-2F, EDT100, EDT140, EDT85, FW35, FW35E, FW40, FW40B, FW40E, FW45, FW50, INDY43F, INDY48F, INDY53F, INDY60F, SP68DE, SP68E, TR100, TR140, TR90, TR-E100, TR-E150, TR-E170, TR-E200, TR-E230, TS43, TS48, UNI43C, UNI48C, UNI48CD, UNI53C, UNI60C				

	GEV No.	510303	Ref. No.	31014 456030 H200818
description O-ring EPDM thickness 1.78mm ID ø 6.75mm Qty 1 pcs				
For models: APS43, APS48, APS48B, APS53, APS60, BPS43, C68DE, C68E, C81E, C81EBT, C90, C90DE, C90DE2, C90E, C90E2, C90EBT, C90EBT2, C98, CA120, CA55, CA90, ED550, ED650E, ED650S, FW35, FW40, FW40B, FW45, FW50, LO50, LO50E, LO62, RCA1100, RCA1200, RCA1200i, RLO50, SMW15, SMW15E, SP68DE, SP68E, SP81E, TS43, TS48, US-X501				





Зип Общепит
vsezip.ru
+7(812)98708-81

			
1			
GEV No.	510307	Ref. No.	261009 H261009
description	Thumb screw thread M6 H 3mm thread L 8mm ø 28mm SS		
For models:	C35, C35E, C43, C43-2, C43ALTA, C43D, C43DE, C43E, C46DE, C46E, C48, C48-2, C48D, C48D-2, C48DDL, C48DL, C48E, C6, C68DE, C68E, C68EBT, C6D, C6DE, C6E, C6EBT, C90DE2, C90E2, C90EBT2, C98, CA120, CA55, CA90, CAP10, CAP10BT, CAP10DE, CAP12, CAP12DE, CAP12EBT, CAP15EBT, CAP7, CAP7E, ED550, ED650E, ED650S, EDI13-2, EDI13ALTA-2, EDI13ALTABT, EDI13BT, EDI4, EDI6-2...(Other models you can see in the webshop)		

spare parts for 510272			
GEV No.	560052	Ref. No.	—
description	side bolts thread M5 L 10mm SS Qty 20 pcs intake slotted head ø 2.5mm		
GEV No.	560140	Ref. No.	30194
description	hexagonal nut thread M4 H 4.8mm SS WS 7 Qty 20 pcs DIN/ISO DIN 985 self-locking		
GEV No.	560454	Ref. No.	—
description	flat-headed bolt thread M4 thread L 22mm SS DIN 84/ISO 1207 Qty 1 pcs intake slotted head ø 7mm head thickness 2.5mm		

			
1			
GEV No.	510871	Ref. No.	H191022
description	wash arm boss		

			
1			
GEV No.	510317	Ref. No.	170930 H170930
description	blank nozzle mounting pos. centre for rinse arm		
For models:	C68DE, C68E, CA120, CA55, CA90, ED550, ED650E, ED650S, RCA1100, RCA1200, RCA1200i, SP68DE, SP68E		

			
1			
GEV No.	510272	Ref. No.	33479
description	rinse arm L 500mm mounting pos. upper/lower nozzles 6 mounting ø 12mm		
For models:	CA55, CA90, ED550, ED650E, RCA1100, RCA1200, RCA1200i		

			
1			
GEV No.	510313	Ref. No.	190617 H190617
description	bush H 12mm D1 ø 20mm D2 ø 16mm D3 ø 12mm for wash arm boss		
For models:	60EBT, C53DE, C53E, C60DE, C60E, C68DE, C68E, CA120, CA55, CA90, DP45DE, DP45E, DP50DE, DP50E, DP50EBT, ED550, ED650E, ED650S, RCA1100, RCA1200, RCA1200i, SP45DE, SP45E, SP50DE, SP50E, SP50E-400V3-50Hz-MARINE, SP50E-440V3-60Hz-MARINE, SP68DE, SP68E, ST53DE, ST53E, ST60DE, ST60E, ST60EBT		

spare parts for 510272				
	GEV No.	508122	Ref. No.	—
end cap				
	GEV No.	510303	Ref. No.	31014 456030 H200818
O-ring EPDM thickness 1.78mm ID ø 6.75mm Qty 1 pcs				
	GEV No.	510307	Ref. No.	261009 H261009
Thumb screw thread M6 H 3mm thread L 8mm ø 28mm SS				
	GEV No.	510309	Ref. No.	170911 H170911
nozzle for rinse arm mounting pos. right/left				
	GEV No.	510310	Ref. No.	170704 H170704
opposite support for rinse jet				
	GEV No.	510313	Ref. No.	190617 H190617
bush H 12mm D1 ø 20mm D2 ø 16mm D3 ø 12mm for wash arm boss				
	GEV No.	510315	Ref. No.	170929 H170929
nozzle for rinse arm mounting pos. centre/inside				
	GEV No.	510317	Ref. No.	170930 H170930
blank nozzle mounting pos. centre for rinse arm				
	GEV No.	510872	Ref. No.	191030 H191030
rinse arm boss				

			
1			
GEV No.	510315	Ref. No.	170929 H170929
description	nozzle for rinse arm mounting pos. centre/inside		
For models:	C68DE, C68E, CA120, CA55, CA90, ED550, ED650E, ED650S, RCA1100, RCA1200, RCA1200i, SP68DE, SP68E		

			
1			
GEV No.	510309	Ref. No.	170911 H170911
description	nozzle for rinse arm mounting pos. right/left		
For models:	C68DE, C68E, C81E, C81EBT, C90, C90DE, C90DE2, C90E, C90E2, C90EBT, C90EBT2, C98, CA120, CA55, CA90, ED550, ED650E, ED650S, LO50, LO50E, LO62, RCA1100, RCA1200, RCA1200i, RLO50, SMW15, SMW15E, SP68DE, SP68E, SP81E, US-X501		



			
1			
GEV No.	510310	Ref. No.	170704 H170704
description	opposite support for rinse jet		
For models:	C68DE, C68E, C81E, C81EBT, C90, C90DE, C90DE2, C90E, C90E2, C90EBT, C90EBT2, C98, CA120, CA55, CA90, ED550, ED650E, ED650S, LO50, LO50E, LO62, RCA1100, RCA1200, RCA1200i, RLO50, SMW15, SMW15E, SP68DE, SP68E, SP81E, US-X501		



			
1			
GEV No.	510303	Ref. No.	31014 456030 H200818
description	O-ring EPDM thickness 1.78mm ID ø 6.75mm Qty 1 pcs		
For models:	APS43, APS48, APS48B, APS53, APS60, BPS43, C68DE, C68E, C81E, C81EBT, C90, C90DE, C90DE2, C90E, C90E2, C90EBT, C90EBT2, C98, CA120, CA55, CA90, ED550, ED650E, ED650S, FW35, FW40, FW40B, FW45, FW50, LO50, LO50E, LO62, RCA1100, RCA1200, RCA1200i, RLO50, SMW15, SMW15E, SP68DE, SP68E, SP81E, TS43, TS48, US-X501		







			
1			
GEV No.	510872	Ref. No.	191030 H191030
description	rinse arm boss		
For models:	CA120, CA55, CA90, ED550, ED650E, ED650S, RCA1100, RCA1200, RCA1200i		

			
1			
GEV No.	510307	Ref. No.	261009 H261009
description	Thumb screw thread M6 H 3mm thread L 8mm ø 28mm SS		
For models:	C35, C35E, C43, C43-2, C43ALTA, C43D, C43DE, C43E, C46DE, C46E, C48, C48-2, C48D, C48D-2, C48DDL, C48DL, C48E, C6, C68DE, C68E, C68EBT, C6D, C6DE, C6E, C6EBT, C90DE2, C90E2, C90EBT2, C98, CA120, CA55, CA90, CAP10, CAP10BT, CAP10DE, CAP12, CAP12DE, CAP12EBT, CAP15EBT, CAP7, CAP7E, ED550, ED650E, ED650S, EDI13-2, EDI13ALTA-2, EDI13ALTABT, EDI13BT, EDI4, EDI6-2...(Other models you can see in the webshop)		

			
1			
GEV No.	512222	Ref. No.	21899
description	wash arm L 290mm nozzles 4 mounting ø 14/27mm mounting pos. upper		
For models:	APS43, APS48B, APSE43, FW35		

			
1			
GEV No.	512223	Ref. No.	21866
description	wash arm L 345mm nozzles 4 mounting ø 26.5mm mounting pos. upper		
For models:	APS43, APS48, APS48B, APS53, APSE43, APSE48, APSE53, FW35, FW40, FW40B, FW45		
spare parts for	512223		
	GEV No.	512091	Ref. No.
end cap			30516

spare parts for 512225			
	GEV No.	512194	Ref. No.
rinse arm boss ø 84mm H 30mm			32360
	GEV No.	512231	Ref. No.
wash jet			29156
	GEV No.	512240	Ref. No.
bush for rinse arm			32282

			
1			
GEV No.	512225	Ref. No.	21867
description	wash arm L 415mm nozzles 5 mounting ø 26.5mm mounting pos. lower		
For models:	APS48, APS48B, APS53, APSE48, FW40, FW40B		
spare parts for	512225		
	GEV No.	512091	Ref. No.
end cap			30516
	GEV No.	512194	Ref. No.
rinse arm boss ø 84mm H 30mm			32360
	GEV No.	512231	Ref. No.
wash jet			29156
	GEV No.	512240	Ref. No.
bush for rinse arm			32282
	GEV No.	512278	Ref. No.
shim			18345











			
1			
GEV No.	512227	Ref. No.	21884
description	wash arm L 472mm nozzles 5 mounting ø 14/26mm mounting pos. lower		
For models:	APS60, APSE60, FW50		
spare parts for	512227		
	GEV No.	512091	Ref. No.
end cap			30516
	GEV No.	512157	Ref. No.
nut thread M12			15362

Table continues overleaf



spare parts for 512227	
	GEV No. 512158 Ref. No. 29358 rinse jet holder L 70mm nozzles 1 mounting ø 12mm mounting pos. lower
	GEV No. 512231 Ref. No. 29156 wash jet
	GEV No. 512241 Ref. No. 17920 screw

	
1	
GEV No.	512226 Ref. No. 21868
description	wash arm L 485mm nozzles 6 mounting ø 14/27mm mounting pos. lower
For models:	APS53, APSE53, FW45

spare parts for 512226	
	GEV No. 512091 Ref. No. 30516 end cap
	GEV No. 512194 Ref. No. 32360 rinse arm boss ø 84mm H 30mm
	GEV No. 512231 Ref. No. 29156 wash jet
	GEV No. 512240 Ref. No. 32282 bush for rinse arm

	
1	
GEV No.	512091 Ref. No. 30516
description	end cap
For models:	APS43, APS48, APS48B, APS53, APS60, APSE43, APSE48, APSE53, APSE60, C3, C35, C4, C43, C43D, C48, C48D, C53, C53D, C60, C60D, DP35, DP35D, DP40, DP40D, DP45, DP45D, DP50, DP50D, FW35, FW40, FW40B, FW45, FW50, SP35, SP35D, SP40, SP40D, SP45, SP45D, SP50, SP50-400V, SP50-440V, SP50D, SPB35, STS43, STS43D, STS48, STS48D, STS53, STS53D...(Other models you can see in the webshop)







	
1	
GEV No.	512020 Ref. No. 25111
description	end cap for rinse arm
For models:	APS43, APS48, APS53, APS60, APSE43, APSE48, APSE53, APSE60, BPN48, BPS43, BPS52, C3, C4, E40-2F, M60, T3-80, T4-80, T5-80, T6-80

Зип Общепит

	
1	
GEV No.	512231 Ref. No. 29156
description	wash jet
For models:	APS43, APS48, APS48B, APS53, APS60, APSE43, APSE48, APSE53, APSE60, FW35, FW40, FW40B, FW45, FW50

	
1	
GEV No.	512001 Ref. No. 20502/R
description	rinse arm complete

	
1	
GEV No.	512228 Ref. No. 21863
description	rinse arm L 345mm mounting ø 34.5mm nozzles 4 mounting pos. lower
For models:	APS43, APS48, APS48B, APS53, APSE43, C3, DP35, DP35D, FW35, STS43, STS43D, STS48, STS48D

spare parts for 512228	
	GEV No. 512079 Ref. No. 29695 rinse jet
	GEV No. 512091 Ref. No. 30516 end cap
	GEV No. 512194 Ref. No. 32360 rinse arm boss ø 84mm H 30mm
	GEV No. 512238 Ref. No. 17917 34351 rinse arm shaft
	GEV No. 512244 Ref. No. 32359 nut for wash arm
	GEV No. 512278 Ref. No. 18345 shim





1

GEV No.	512229	Ref. No.	21864
description	rinse arm L 420mm mounting \varnothing 14/34.5mm nozzles 5 mounting pos. lower		
For models:	APS48, APS48B, APS53, APSE48, C4, DP40, DP40D, DP45, FW40, FW40B, STS48, STS48D, STS53		
spare parts for	512229		
	GEV No.	512079	Ref. No. 29695
			rinse jet
	GEV No.	512091	Ref. No. 30516
			end cap
	GEV No.	512194	Ref. No. 32360
			rinse arm boss \varnothing 84mm H 30mm
	GEV No.	512238	Ref. No. 17917 34351
			rinse arm shaft
	GEV No.	512244	Ref. No. 32359
			nut for wash arm
	GEV No.	512278	Ref. No. 18345
			shim
	GEV No.	517622	Ref. No. 32178
			rinse arm L 180mm nozzles 3 mounting \varnothing 19mm





1

GEV No.	512014	Ref. No.	21865
description	rinse arm L 485mm mounting \varnothing 14mm nozzles 6 mounting pos. lower		
For models:	APS53, APS60, APSE53, C53, C53D, C60, C60D, DP45, DP45D, DP50, DP50D, FW45, FW50, SP45, SP45D, SP50, SP50-400V, SP50-440V, SP50D, STS53, STS53D, STS60, STS60D		
spare parts for	512014		
	GEV No.	512079	Ref. No. 29695
			rinse jet
	GEV No.	512091	Ref. No. 30516
			end cap
	GEV No.	512194	Ref. No. 32360
			rinse arm boss \varnothing 84mm H 30mm

Зип-Общепит

vsezip.ru

+7(812)987-08-81

	GEV No.	512238	Ref. No.	17917 34351
				rinse arm shaft
	GEV No.	512244	Ref. No.	32359
				nut for wash arm
	GEV No.	512278	Ref. No.	18345
				shim



1

GEV No.	512167	Ref. No.	20901 21892
description	rinse arm L 520mm mounting \varnothing 10mm nozzles 6 mounting pos. upper/lower		
For models:	ED650E, ED650S, K80F		



1

GEV No.	512230	Ref. No.	21882
description	rinse arm L 520mm mounting \varnothing 14mm nozzles 6 mounting pos. lower		
For models:	APS60, APSE60, FW50		



1

GEV No.	512091	Ref. No.	30516
description	end cap		
For models:	APS43, APS48, APS48B, APS53, APS60, APSE43, APSE48, APSE53, APSE60, C3, C35, C4, C43, C43D, C48, C48D, C53, C53D, C60, C60D, DP35, DP35D, DP40, DP40D, DP45, DP45D, DP50, DP50D, FW35, FW40, FW40B, FW45, FW50, SP35, SP35D, SP40, SP40D, SP45, SP45D, SP50, SP50-400V, SP50-440V, SP50D, SPB35, STS43, STS43D, STS48, STS48D, STS53, STS53D...(Other models you can see in the webshop)		



1

GEV No.	512156	Ref. No.	29348
description	rinse arm L 138mm nozzles 1 mounting \varnothing 22mm mounting pos. lower		
For models:	ED650E, ED650S, K80F		





Зип Общепит

vsezip.ru

+7(812)987-08-81







			
1			
GEV No.	517622	Ref. No.	32178
description	rinse arm L 180mm nozzles 3 mounting ø 19mm		
For models:	APS43, APS48, APS48B, APS53, APSE43, APSE48, APSE53, BPN49, BPS43, BPS52, C3, C4, DP35, DP35D, DP40, DP40D, DP45, DP45D, DP50, DP50D, FW35, FW40, FW40B, FW45, STS43, STS43D, STS48, STS48D, STS53, STS53D, STS60, STS60D		

			
1			
GEV No.	517794	Ref. No.	32179
description	rinse arm mounting pos. lower L 180mm nozzles 2 mounting ø 19mm		
For models:	APS43, APS48, APS48B, APS53, APSE43, APSE48, APSE53, BPN48, BPS43, BPS52, C3, C4, DP35, DP35D, DP40, DP40D, DP45, DP45D, DP50, DP50D, FW35, FW40, FW40B, FW45, STS43, STS43D, STS48, STS48D, STS53, STS53D, STS60, STS60D		

			
1			
GEV No.	512194	Ref. No.	32360
description	rinse arm boss ø 84mm H 30mm		
For models:	APS43, APS48, APS48B, APS53, APS60, APSE43, APSE48, APSE53, APSE60, C3, C4, C53, C53D, C60, C60D, DP35, DP35D, DP40, DP40D, DP45, DP45D, DP50, DP50D, FW35, FW40, FW40B, FW45, FW50, SP45, SP45D, SP50, SP50-400V, SP50-440V, SP50D, STS43, STS43D, STS48, STS48D, STS53, STS53D, STS60, STS60D		

			
1			
GEV No.	512079	Ref. No.	29695
description	rinse jet		
For models:	APS43, APS48, APS48B, APS53, APS60, APSE43, APSE48, APSE53, APSE60, C3, C35, C4, C43, C43D, C48, C48D, C53, C53D, C60, C60D, DP35, DP35D, DP40, DP40D, DP45, DP45D, DP50, DP50D, ED600-95, ED630-90, ED650E, ED650S, ED700-90, ED900-90, EDI5, FW35, FW40, FW40B, FW45, FW50, K80F, LO122, LO60, LO61, LO78, SP35, SP35D, SP40, SP40D, SP45...(Other models you can see in the webshop)		

			
1			
GEV No.	512330	Ref. No.	26463
description	rinse jet		
For models:	ED650E-90, ED650S-90, ED700, ED900		

			
1			
GEV No.	512013	Ref. No.	20095
description	rinse arm L 280mm mounting ø 11mm nozzles 4 mounting pos. upper/lower complete		
For models:	C35, C43, C43D, C48, C48D, SP35, SP35D, SP40, SP40D, SPB35, T3-80		
spare parts for	512013		
	GEV No.	512019	Ref. No. 25109
	GEV No.	512079	Ref. No. 29695
	GEV No.	512087	Ref. No. 25110
	GEV No.	512091	Ref. No. 30516
accessories for	512013		
	GEV No.	512092	Ref. No. 33748
	GEV No.	512256	Ref. No. 33747









			
1			
GEV No.	512284	Ref. No.	20096
description	rinse arm L 335mm mounting ø 11.5mm nozzles 4 mounting pos. upper		
For models:	T3-80, T4-80		
spare parts for	512284		
	GEV No.	512019	Ref. No. 25109
	GEV No.	512020	Ref. No. 25111
	GEV No.	512080	Ref. No. 21021 25136
	GEV No.	512087	Ref. No. 25110

Table continues overleaf

spare parts for		512284		
	GEV No.	512094	Ref. No.	22155 25059
	rinse jet			
	GEV No.	512304	Ref. No.	—
	rinse jet			







1

GEV No.	512285	Ref. No.	20097	
description	rinse arm L 410mm mounting ø 12mm nozzles 5 mounting pos. lower			
For models:	T4-80, T5-80			
spare parts for		512285		
	GEV No.	510196	Ref. No.	25069
	rinse jet			
	GEV No.	512019	Ref. No.	25109
	rinse arm boss			
	GEV No.	512020	Ref. No.	25111
	end cap for rinse arm			
	GEV No.	512087	Ref. No.	25110
	nut thread M12			



1





GEV No.	512208	Ref. No.	20098	
description	rinse arm L 477mm mounting ø 12mm nozzles 6 mounting pos. lower			
For models:	M60, T5-80, T6-80			
spare parts for		512208		
	GEV No.	512019	Ref. No.	25109
	rinse arm boss			
	GEV No.	512020	Ref. No.	25111
	end cap for rinse arm			
	GEV No.	512080	Ref. No.	21021 25136
	rinse jet			
	GEV No.	512087	Ref. No.	25110
	nut thread M12			
	GEV No.	512094	Ref. No.	22155 25059
	rinse jet			

Зип-Общепит

spare parts for		512208		
	GEV No.	512282	Ref. No.	—
	rinse jet			



1

GEV No.	512161	Ref. No.	20099	
description	rinse arm L 515mm mounting ø 12mm nozzles 6 mounting pos. lower			
For models:	M60, T6-80			
spare parts for		512161		
	GEV No.	512019	Ref. No.	25109
	rinse arm boss			
	GEV No.	512020	Ref. No.	25111
	end cap for rinse arm			
	GEV No.	512082	Ref. No.	25062
	swirl			
	GEV No.	512087	Ref. No.	25110
	nut thread M12			
	GEV No.	512094	Ref. No.	22155 25059
	rinse jet			
	GEV No.	512136	Ref. No.	25179 25789
	wing nuts for filter			
	GEV No.	512282	Ref. No.	—
	rinse jet			

1

GEV No.	512091	Ref. No.	30516
description	end cap		
For models:	APS43, APS48, APS48B, APS53, APS60, APSE43, APSE48, APSE53, APSE60, C3, C35, C4, C43, C43D, C48, C48D, C53, C53D, C60, C60D, DP35, DP35D, DP40, DP40D, DP45, DP45D, DP50, DP50D, FW35, FW40, FW40B, FW45, FW50, SP35, SP35D, SP40, SP40D, SP45, SP45D, SP50, SP50-400V, SP50-440V, SP50D, SPB35, STS43, STS43D, STS48, STS48D, STS53, STS53D...(Other models you can see in the webshop)		

1

GEV No.	512019	Ref. No.	25109
description	rinse arm boss		
For models:	C35, C43, C43D, C48, C48D, M60, SP35, SP35D, SP40, SP40D, SPB35, T3-80, T4-80, T5-80, T6-80		



Зип Общепит
vsezip.ru
8(12)987-08-81

1			
GEV No.	512079	Ref. No.	29695
description	rinse jet		
For models:	APS43, APS48, APS48B, APS53, APS60, APSE43, APSE48, APSE53, APSE60, C3, C35, C4, C43, C43D, C48, C48D, C53, C53D, C60, C60D, DP35, DP35D, DP40, DP40D, DP45, DP45D, DP50, DP50D, ED630-90, ED630-90D, ED650E, ED650S, ED700-90, ED900-90, EDI5, FW35, FW40, FW40B, FW45, FW50, K80F, LO122, LO60, LO61, LO78, SP35, SP35D, SP40, SP40D, SP45...(Other models you can see in the webshop)		

1			
GEV No.	512163	Ref. No.	20108
description	wash arm		
For models:	CM52, CMD52, E50, NK52, NKD52, UNI53R, UNI53RD		

1			
GEV No.	512080	Ref. No.	21021 25136
description	rinse jet		
For models:	APS43, APS48, APS48B, APS53, APSE43, C3, C4, CM43, CM48, CM52, CM60, CMD43, CMD48, CMD52, CMD60, E36, E40, E40-2F, E43, E50, FW35, FW40, FW40B, FW45, INDY43F, K80G, M60, NK43, NK48, NK52, NK60, NKD43, NKD48, NKD52, NKD60, T3-80, T4-80, T5-80, T6-80, TS43, UNI43C, UNI43R, UNI43RD, UNI48R, UNI48RD, UNI53R, UNI53RD		

1			
GEV No.	512180	Ref. No.	25076
description	wash arm H 125mm L 260mm mounting ø 40mm nozzles 3 mounting pos. lower		
For models:	CM43, CMD43, E36, E40, E43, NK43, NKD43, UNI43R, UNI43RD		

1			
GEV No.	512094	Ref. No.	22155 25059
description	rinse jet		
For models:	APS43, APS48, APS48B, APS53, APS60, C53, C53D, C60, C60D, CM43, CM48, CM52, CM60, CMD43, CMD48, CMD52, CMD60, DP35, DP35D, DP40, DP40D, DP45, DP45D, DP50, DP50D, E36, E40, E43, E50, ED650E-90, ED650S-90, ED700, ED900, FW35, FW40, FW40B, FW45, FW50, K80G, NK43, NK48, NK52, NK60, NKD43, NKD48, NKD52, NKD60, SP45, SP45D, SP50...(Other models you can see in the webshop)		

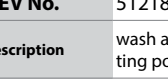
1			
GEV No.	512216	Ref. No.	20107
description	wash arm H 525mm L 280mm mounting ø 38.5mm nozzles 13 mounting pos. lower		
For models:	CM48, CMD48, NK48, NKD48, UNI48R, UNI48RD		

1			
GEV No.	512082	Ref. No.	25062
description	swirl		
For models:	APS43, APS48, APS53, APS60, APSE43, APSE48, APSE53, APSE60, C3, C4, C53, C60, ED700, ED900, INDY43F, INDY53F, INDY60F, M60, T3-80, T4-80, T5-80, T6-80, UNI43C, UNI48C, UNI48CD, UNI53C, UNI60C		

1			
GEV No.	512218	Ref. No.	25080
description	end cap		
For models:	CM48, CM52, CM60, CMD48, CMD52, CMD60, E50, NK48, NK52, NK60, NKD48, NKD52, NKD60, UNI48R, UNI48RD, UNI53R, UNI53RD		

1			
GEV No.	512162	Ref. No.	20106
description	wash arm		
For models:	CM43, CMD43, E36, E40, E43, NK43, NKD43, UNI43R, UNI43RD		

1			
GEV No.	512217	Ref. No.	25259
description	flat gasket rubber ED ø 61mm ID ø 47.5mm thickness 3mm Qty 1 pcs equiv. no. 25259 suitable for HOONVED		
For models:	CM43, CM48, CM52, CM60, CMD43, CMD48, CMD52, CMD60, E36, E40, E43, E50, NK43, NK48, NK52, NK60, NKD43, NKD48, NKD52, NKD60, UNI43R, UNI43RD, UNI48R, UNI48RD, UNI53R, UNI53RD		

Зип Общепит

vsezip.ru

812)987-08-81

			
1			
GEV No.	512127	Ref. No.	25007
description	nut for drain assembly thread 1½" ED ø 69mm		
For models:	CM43, CM48, CM52, CM60, CMD43, CMD48, CMD52, CMD60, E36, E40, E43, E50, ED600-95, ED630-90, ED650E, ED650E-90, ED650S, ED650S-90, ED700, ED700-90, ED900, ED900-90, EDI5, K80F, K80G, LO122, LO60, LO61, LO78, NK43, NK48, NK52, NK60, NKD43, NKD48, NKD52, NKD60, UNI43R, UNI43RD, UNI48R, UNI48RD, UNI53R, UNI53RD		

			
1			
GEV No.	512190	Ref. No.	25078
description	wash arm L 290mm nozzles 1 mounting ø 30mm mounting pos. upper		
For models:	CM43, CMD43, E36, E40, E43, NK43, NKD43, UNI43R, UNI43RD		

			
1			
GEV No.	512170	Ref. No.	25073
description	wash jet		
For models:	CM43, CM48, CMD43, CMD48, E36, E40, E43, NK43, NK48, NKD43, NKD48, UNI43R, UNI43RD, UNI48R, UNI48RD		

			
1			
GEV No.	512219	Ref. No.	25074
description	wash jet		
For models:	CM52, CM60, CMD52, CMD60, E50, NK52, NK60, NKD52, NKD60, UNI53R, UNI53RD		

			
1			
GEV No.	512220	Ref. No.	25075
description	wash jet		
For models:	CM52, CM60, CMD52, CMD60, E50, NK52, NK60, NKD52, NKD60, UNI53R, UNI53RD		

			
1			
GEV No.	510728	Ref. No.	33795
description	wash arm L 250mm mounting pos. lower nozzles 4 mounting ø 25mm suitable for B23-27-10-11		
For models:	CDN3, CDN4, CR43, CR43D, CR48, CR48D, SPR36, SPR36D, SPR41, SPR41D		
spare parts for	510728		
	GEV No.	510731	Ref. No.
			—
	GEV No.	560140	Ref. No.
			30194
	hexagonal nut thread M4 H 4.8mm SS WS 7 Qty 20 pcs DIN/ISO DIN 985 self-locking		

			
1			
GEV No.	510732	Ref. No.	33800
description	wash arm L 280mm mounting pos. upper nozzles 2 suitable for B20-B10t		
For models:	CDN3, CR43, CR43D, CR48, SPR36, SPR36D, SPR41		

			
1			
GEV No.	510280	Ref. No.	33805
description	wash arm L 282mm mounting pos. upper nozzles 2 lateral Hmm suitable for B23-12t		
For models:	CDN4, CR48, CR48D, SPR41, SPR41D		

			
1			
GEV No.	510761	Ref. No.	25263
description	flat gasket rubber D1 ø 38mm D2 ø 25mm thickness 2mm Qty 1 pcs		
For models:	60BT, 60BT-3, 60EBT, APS43, APS48, APS48B, APS53, APS60, APSE43, APSE48, APSE53, APSE60, BPN48, BPS43, BPS52, C3, C35, C35E, C4, C43, C43-2, C43ALTA, C43D, C43DE, C43E, C46DE, C46E, C48, C48-2, C48D, C48D-2, C48DDL, C48DL, C48E, C53, C53D, C53DE, C53E, C6, C60, C60D, C60DE, C60E, C68DE, C68E, C68EBT, C6D, C6DE, C6E, C6EBT...(Other models you can see in the webshop)		





Зип Общепит

vsezip.ru

+7(812)987-08-81

			
1			
GEV No.	510734	Ref. No.	33799
description	nozzle for wash arm suitable for B23-10-11-12		
For models:	CDN3, CDN4, CR43, CR43D, CR48, CR48D, SPR36, SPR36D, SPR41, SPR41D		

			
1			
GEV No.	510736	Ref. No.	33802
description	nozzle for wash arm suitable for B23-10-12		
For models:	CDN3, CDN4, CR43, CR43D, CR48, CR48D, SPR36, SPR36D, SPR41, SPR41D		

			
1			
GEV No.	510735	Ref. No.	33801
description	nozzle holder for wash arm		
For models:	CDN3, CDN4, CR43, CR43D, CR48, CR48D, SPR36, SPR36D, SPR41, SPR41D		

			
1			
GEV No.	511200	Ref. No.	15242
description	nut thread 1" H 6mm brass WS 45 Qty 1 pcs		
For models:	CDN3, CDN4, CM52, CM60, CMD52, CMD60, CR43, CR43D, CR48, CR48D, K80F, K80G, M60, NK52, NK60, NKD52, NKD60, SPR36, SPR36D, SPR41, SPR41D, T5-80, T6-80, UNI43R, UNI43RD, UNI48R, UNI48RD, UNI53R, UNI53RD		



			
1			
GEV No.	507309	Ref. No.	33798
description	O-ring EPDM thickness 2.62mm ID ø 17.13mm Qty 1 pcs		
For models:	CDN3, CDN4, CR43, CR43D, CR48, CR48D, SPR36, SPR36D, SPR41, SPR41D		

			
1			
GEV No.	510737	Ref. No.	33789
description	rinse arm L 205mm mounting pos. upper nozzles 3 mounting ø 12mm complete with nozzle		
For models:	CDN3, CDN4, CR43, CR43D, CR48, CR48D, SPR36, SPR36D, SPR41, SPR41D		

			
1			
GEV No.	512193	Ref. No.	33794
description	rinse arm L 240mm mounting ø 12mm nozzles 3 suitable for HOONVED mounting pos. lower		
For models:	CDN3, CDN4, CR43, CR43D, CR48, CR48D, SPR36, SPR36D, SPR41, SPR41D		

			
1			
GEV No.	510323	Ref. No.	160734 33793
description	end cap for rinse arm		
For models:	C35, C35E, C43, C43-2, C43ALTA, C43D, C43DE, C43E, C46DE, C46E, C48, C48-2, C48D, C48D-2, C48DDL, C48DL, C48E, C6, C6D, C6DE, C6E, C6EBT, CDN3, CDN4, CR43, CR43D, CR48, CR48D, GS-X1011, GS-X1011-2, GS-X1011-WEH, GS-X1011-WEH-2, RSP40, RSP40A, SP35, SP35-2, SP35ALTA, SP35D, SP35DE, SP35E, SP40, SP40-2, SP40D, SP40D-2, SP40DDL, SP40DE, SP40DL, SP40E, SP5, SP5D...(Other models you can see in the webshop)		

			
1			
GEV No.	510885	Ref. No.	33784
description	gasket suitable for COMENDA equiv. no. 200464 L 60mm W 30mm		
For models:	CDN3, CDN4, CR43, CR43D, CR48, CR48D, SPR36, SPR36D, SPR41, SPR41D		

			
1			
GEV No.	510327	Ref. No.	170946 33791 H170946
description	nozzle for rinse arm		
For models:	C35, C35E, C43, C43-2, C43ALTA, C43D, C43DE, C43E, C46DE, C46E, C48, C48-2, C48D, C48D-2, C48DDL, C48DL, C48E, C6, C6D, C6DE, C6E, C6EBT, CDN3, CDN4, CR43, CR43D, CR48, CR48D, GS-X1011, GS-X1011-2, GS-X1011-WEH, GS-X1011-WEH-2, RSP40, RSP40A, SP35, SP35-2, SP35ALTA, SP35D, SP35DE, SP35E, SP40, SP40-2, SP40D, SP40D-2, SP40DDL, SP40DE, SP40DL, SP40E, SP5, SP5D...(Other models you can see in the webshop)		
accessories for	510327		
	GEV No.	510902	Ref. No. 33790
	O-ring EPDM thickness 2mm ID ø 9.5mm Qty 1 pcs		



Зип Общепит

vsezip.ru

812)9813897

1			
GEV No.	528583	Ref. No.	33792
description	O-ring EPDM thickness 2.62mm ID ø 9.13mm Qty 1 pcs		
For models:	C35, C35E, C43, C43-2, C43ALTA, C43D, C43DE, C43E, C46DE, C46E, C48, C48-2, C48D, C48D-2, C48DDL, C48DL, C48E, C6, C6D, C6DE, C6E, C6EBT, CDN3, CDN4, CR43, CR43D, CR48, CR48D, GS-X1011, GS-X1011-2, GS-X1011-WEH, GS-X1011-WEH-2, RSP40, RSP40A, SP35, SP35-2, SP35ALTA, SP35D, SP35DE, SP35E, SP40, SP40-2, SP40D, SP40D-2, SP40DDL, SP40DE, SP40DL, SP40E, SP5, SP5D...(Other models you can see in the webshop)		

1			
GEV No.	510902	Ref. No.	33790
description	O-ring EPDM thickness 2mm ID ø 9.5mm Qty 1 pcs		
For models:	C35, C35E, C43, C43-2, C43ALTA, C43D, C43DE, C43E, C46DE, C46E, C48, C48-2, C48D, C48D-2, C48DDL, C48DL, C48E, C6, C6D, C6DE, C6E, C6EBT, C81, C81E, C81EBT, C90, C90DE, C90E, C90EBT, CDN3, CDN4, CR43, CR43D, CR48, CR48D, EDI13, EDI13ALTA, EDI6, EDI8, GS-X1011, GS-X1011-2, GS-X1011-WEH, GS-X1011-WEH-2, LO134, LO134ALTA, LO50, LO50E, LO67, LO83, RLO200...(Other models you can see in the webshop)		

1				
GEV No.	512189	Ref. No.	430176	
description	rinse arm L 485mm mounting pos. upper/lower nozzles 4 mounting ø 25.4mm complete with nozzle suitable for COMENDA, HOONVED			
For models:	AC101, AC151, AC181, AC201, AC241, AC91, EDT100, EDT140, EDT170, EDT200, EDT230, EDT85			
spare parts for	512189			
	GEV No.	511220	Ref. No.	380323 H380323
	nozzle for rinse arm			
	GEV No.	530293	Ref. No.	H200809
	O-ring EPDM thickness 1.78mm ID ø 8.73mm Qty 1 pcs			

1			
GEV No.	510277	Ref. No.	430136 H430136
description	rinse arm L 485mm mounting pos. upper/lower nozzles 6 mounting ø 25mm complete with nozzle		

1			
GEV No.	511220	Ref. No.	380323 H380323
description	nozzle for rinse arm		
For models:	AC101, AC151, AC181, AC201, AC241, AC91, EDT100, EDT140, EDT170, EDT200, EDT230, EDT85, HT10J, HT150, HTP195, HTP205, HTP220, TR100, TR90, TR-E100, TR-E150		

1			
GEV No.	530293	Ref. No.	H200809
description	O-ring EPDM thickness 1.78mm ID ø 8.73mm Qty 1 pcs		
For models:	EDI13, EDI13-2, EDI13ALTA, EDI13ALTA-2, EDI13ALTABT, EDI13BT, EDI4, EDI6, EDI6-2, EDI6BT, EDI8, EDI8-2, EDI8BT, EDT100, EDT140, EDT170, EDT200, EDT230, EDT85, LO134, LO134-2, LO134ALTA, LO134ALTA-2, LO56, LO67, LO67-2, LO83, LO83-2, RLO200, RLO300, RLO400, TR100, TR140, TR170, TR200, TR230, TR90, TR-E100, TR-E150, TR-E170, TR-E200, TR-E230, TR-E90		

1			
GEV No.	512084	Ref. No.	31313
description	opposite support for rinse jet		
For models:	APS43, APS48, APS48B, APS53, APS60, APSE43, APSE48, APSE53, APSE60, C3, C4, C53, C53D, C60, C60D, CM48, CM52, CMD43, CMD52, DP35, DP35D, DP40, DP40D, DP45, DP45D, DP50, DP50D, ED600-95, ED630-90, ED700-90, ED900-90, EDI5, FW35, FW40, FW40B, FW45, FW50, INDY43F, INDY48F, INDY53F, INDY60F, LO122, LO60, LO61, LO78, SP45, SP45D, SP50, SP50-400V, SP50-440V...(Other models you can see in the webshop)		

1			
GEV No.	510196	Ref. No.	25069
description	rinse jet		

1			
GEV No.	510197	Ref. No.	25070
description	rinse jet		
For models:	E40-2F, M60, T3-80, T4-80, T5-80, T6-80		



Зип Общепит

vsezip.ru

+7(812)987-08-81



1

GEV No.	512196	Ref. No.	170954
description	rinse jet H 18.5mm		
For models:	AC101, AC151, AC91, EDT100, EDT140, EDT85, HG2LR, HGLR		



1

GEV No.	517627	Ref. No.	31384
description	rinse jet H 24.5mm		
For models:	BPS43, BPS52		



1

GEV No.	512158	Ref. No.	29358
description	rinse jet holder L 70mm nozzles 1 mounting ø 12mm mounting pos. lower		
For models:	APS60, APSE60, ED650E, ED650S, FW50, K80F		



1

GEV No.	512083	Ref. No.	31314
description	rinse jet holder mounting pos. upper		
For models:	APS43, APS48, APS48B, APS53, APS60, APSE43, APSE48, APSE53, APSE60, C3, C4, C53, C53D, C60, C60D, CM48, CM52, CMD43, CMD52, DP35, DP35D, DP40, DP40D, DP45, DP45D, DP50, DP50D, ED600-95, ED630-90, ED700-90, ED900-90, EDI5, FW35, FW40, FW40B, FW45, FW50, INDY43F, INDY48F, INDY53F, INDY60F, LO122, LO60, LO61, LO78, SP45, SP45D, SP50, SP50-400V, SP50-440V...(Other models you can see in the webshop)		



1

GEV No.	510198	Ref. No.	25072
description	swirl hole ø 2.5mm H 4.5mm ø 18.5mm		
For models:	ED700, ED900, K80G, M60, T3-80, T5-80, T6-80		



1

GEV No.	517640	Ref. No.	37722
description	wash jet H 16mm ø 12mm		
For models:	AP43E, AP48E, AP53E, AP60E, FW35E, FW40E		



1

GEV No.	517624	Ref. No.	25135
description	wash jet thread 1/2" IT H 21mm ø 6mm		
For models:	ED700, ED900, K80G		



1

GEV No.	512324	Ref. No.	H190224
description	opposite support mounting pos. lower for wash arm support		
For models:	DP35-2, DP35D-2, DP40-2, DP40D-2, DP40D-rib2, DP40-rib2, GS-X1021-2, GS-X1021-2rib, GS-X1021-WEH-2, GS-X1021-WEH-2rib, ST-43DE, ST43E, ST48DE, ST48E, STS43-2, STS43D-2, STS48-2, STS48D-2, STS48D-rib2, STS48-rib2, TDN4-2rib		



1

GEV No.	512054	Ref. No.	32887
description	wash arm support		
For models:	C3, C4, C43, C48, DP35, DP35D, DP40, DP40D, DP45, DP45D, DP50, DP50D, GS-X1021, GS-X1021-WEH, STS43, STS43D, STS48, STS48D, STS53, STS53D, STS60, STS60D		

Зип Общепит

vsezip.ru

+7(812)987-08-81



1

GEV No.	512243	Ref. No.	32272
description	wash arm support for rinse arm mounting pos. upper		
For models:	APS60, APSE60, FW50		



1

GEV No.	512027	Ref. No.	190941 36280
description	wash arm support mounting pos. lower		
For models:	60EBT, C53DE, C53E, C60DE, C60E, DP45DE, DP45E, DP50DE, DP50E, DP50EBT, SP45DE, SP45E, SP50DE, SP50E, SP50E-400V3-50Hz-MARINE, SP50E-440V3-60Hz-MARINE, ST53DE, ST53E, ST60DE, ST60E, ST60EBT		



1

GEV No.	512051	Ref. No.	21035
description	wash arm support mounting pos. lower		
For models:	INDY43F, INDY48F, INDY53F, INDY60F, UNI43C, UNI48C, UNI48CD, UNI53C, UNI60C		



1

GEV No.	512057	Ref. No.	32350
description	wash arm support mounting pos. lower		
For models:	60BT, 60BT-3, APS43, APS48, APS48B, APS53, APS60, APSE43, APSE48, APSE53, APSE60, C3, C35, C4, C43, C43ALTA, C43D, C48, C48D, C48DDL, C48DL, C53, C53D, C60, C60D, DP35, DP35D, DP40, DP40D, DP45, DP45D, DP50, DP50D, DP50D-115V, FW35, FW40, FW40B, FW45, FW50, GS-X1011, GS-X1011-WEH, GS-X1021, GS-X1021-WEH, RSP50, RSP50A, SD5BT, SP35, SP35ALTA, SP35D, SP40...(Other models you can see in the webshop)		
accessories for	512057		



GEV No.	512245	Ref. No.	33544
description	hose connector thread 1/2" grommet ø 30mm ID ø 16mm grommet length 28mm total length 35mm ED ø 31.5mm		



1

GEV No.	512142	Ref. No.	33700
description	wash arm support mounting pos. lower		
For models:	C35, C43, C43ALTA, C43D, C48, C48D, C48DDL, C48DL, GS-X1011, GS-X1011-WEH, SP35, SP35ALTA, SP35D, SP40, SP40D, SP40DDL, SP40DL, SPB35		



1

GEV No.	512247	Ref. No.	32981 36431
description	wash arm support mounting pos. lower		
For models:	APS43, APS48, APS48B, APS53, APS60, APSE43, APSE48, APSE53, C90, FW35, FW40, FW40B, FW45, FW50, LO50, US-X501		



1

GEV No.	512249	Ref. No.	32357
description	wash arm support mounting pos. lower		
For models:	APS60, APSE60, FW50		



1

GEV No.	512268	Ref. No.	H191083
description	wash arm support mounting pos. lower		
For models:	C35E, C43-2, C43DE, C43E, C46DE, C46E, C48-2, C48D-2, C48E, DP35-2, DP35D-2, DP40-2, DP40D-2, DP40D-rib2, DP40-rib2, GS-X1011-2, GS-X1011-WEH-2, GS-X1021-2, GS-X1021-2rib, GS-X1021-WEH-2, GS-X1021-WEH-2rib, RSP40, RSP40A, SP35-2, SP35DE, SP35E, SP40-2, SP40D-2, SP40DE, SP40E, ST43DE, ST43E, ST48DE, ST48E, STS43-2, STS43D-2, STS48-2, STS48D-2, STS48D-rib2, STS48-rib2, TDN4-2rib		



1

GEV No.	512269	Ref. No.	H190223
description	wash arm support mounting pos. lower		
For models:	C35E, C43-2, C43DE, C43E, C46DE, C46E, C48-2, C48D-2, C48E, GS-X1011-2, GS-X1011-WEH-2, RSP40, RSP40A, SP35-2, SP35DE, SP35E, SP40-2, SP40D-2, SP40DE, SP40E, SPB35E		





1

GEV No.	512711	Ref. No.	35370
description	wash arm support mounting pos. lower		
For models:	C35, GS-X1011, GS-X1011-WEH, SPB35		





Зип Общепит
vsezip.ru
+7(812)987-08-81

			
1			
GEV No.	512294	Ref. No.	16082
description	wash arm support mounting pos. lower D1 ø 46mm D2 ø 49mm D3 ø 60mm H 178mm		
For models:	M60, T5-80		

			
1			
GEV No.	512049	Ref. No.	21906
description	wash arm support mounting pos. upper		

			
1			
GEV No.	511973	Ref. No.	38714
description	wash arm support mounting pos. lower ED ø 55.5mm L 110mm SS ID ø 50.7mm seat ø 20mm		

			
1			
GEV No.	512274	Ref. No.	34314
description	wash arm support mounting pos. upper		
For models:	60BT, 60BT-3, C53, C53D, C60, C60D, DP35, DP35D, DP40, DP40D, DP45, DP45D, DP50, DP50D, DP50D-115V, GS-X1021, GS-X1021-WEH, RSP50, RSP50A, SD5BT, SP45, SP45D, SP50, SP50-400V, SP50-440V, SP50D, STS43, STS43D, STS48, STS48D, STS53, STS53D, STS60, STS60D, TN-TDN5, TN-TDN6, VS-X313, VS-X313-LP-DOS, VS-X515, VS-X515-LP-DOS		

			
1			
GEV No.	524464	Ref. No.	191102 36279
description	wash arm support mounting pos. lower ø 59mm H 88mm ID ø 33mm		
For models:	60EBT, C53DE, C53E, C60DE, C60E, DP45DE, DP45E, DP50DE, DP50E, DP50EBT, SP45DE, SP45E, SP50DE, SP50E, SP50E-400V3-50Hz-MARINE, SP50E-440V3-60Hz-MARINE, STS3DE, STS3E, ST60DE, ST60E, ST60EBT		

			
1			
GEV No.	512308	Ref. No.	31470
description	wash arm support mounting pos. upper		
For models:	C53, C53D, C60, C60D, DP40, DP40D, DP45, DP45D, DP50, DP50D, INDY53F, INDY60F, SP45, SP45D, SP50, SP50-400V, SP50-440V, SP50D, STS48, STS48D, STS53, STS53D, STS60, STS60D, UNI53C, UNI60C		

			
1			
GEV No.	511268	Ref. No.	33471 510503 H510503
description	wash arm support mounting pos. upper		
For models:	C98, CA120, CA55, CA90, CAP7, CAP7E, ED550, ED650E, ED650S, LO62, RCA1100, RCA1200, RCA1200i, SO55, SO55-400V3-50Hz-MARINE, SO55-440V3-60Hz-MARINE, SO55E		

			
1			
GEV No.	512323	Ref. No.	H190222
description	wash arm support mounting pos. upper		
For models:	DP35-2, DP35D-2, DP40-2, DP40D-2, DP40D-rib2, DP40-rib2, GS-X1021-2, GS-X1021-2rib, GS-X1021-WEH-2, GS-X1021-WEH-2rib, ST-43DE, ST43E, ST48DE, ST48E, STS43-2, STS43D-2, STS48-2, STS48D-2, STS48D-rib2, STS48-rib2, TDN4-2rib		

			
1			
GEV No.	512044	Ref. No.	31448
description	wash arm support mounting pos. upper		
For models:	DP35, DP35D, INDY43F, INDY48F, STS43, STS43D, UNI43C, UNI48C, UNI48CD		

			
1			
GEV No.	511954	Ref. No.	38715
description	wash arm support mounting pos. upper ED ø 68mm L 110mm SS seat ø 20mm		

			
1			
GEV No.	512489	Ref. No.	190944
description	wash arm support mounting pos. upper thread M6		



GEV No.	511179	Ref. No.	190215 35F11
description	wash arm support mounting pos. upper thread M8 shaft L 55mm		
For models:	C6, C6D, C6DE, C6E, C6EBT, SP5, SP5D, SP5DE, SP5E		



GEV No.	510319	Ref. No.	33470 510238 H510238
description	wash arm support mounting pos. upper/lower		
For models:	C81, C81E, C81EBT, C90, C90DE, C90E, C90EBT, C98, CA120, CA55, CA90, CAP7, CAP7E, ED550, ED650E, ED650S, LO50, LO50E, LO62, RCA1100, RCA1200, RCA1200i, RLO50, SMW15, SMW15E, SO55, SO55-400V3-50Hz-MARINE, SO55-440V3-60Hz-MARINE, SO55E, SP81, SP81E, US-X501		



GEV No.	510448	Ref. No.	H190209
description	wash arm support with rinse arm shaft mounting pos. upper		
For models:	C35E, C43-2, C43DE, C43E, C46DE, C46E, C48-2, C48D-2, C48E, GS-X1011-2, GS-X1011-WEH-2, RSP40, RSP40A, SP35-2, SP35DE, SP35E, SP40-2, SP40D-2, SP40DE, SP40E, SPB35E		



GEV No.	510114	Ref. No.	190227 H190227
description	wash arm support with rinse arm shaft mounting pos. upper/lower ø 74mm H 142mm		
For models:	C90DE2, C90E2, C90EBT2, CAP10, CAP10BT, CAP10DE, CAP12, CAP12DE, CAP12EBT, CAP15EBT, CAP7E, EDI4, HD40ALTABT, HD40BT, LO56, SO100, SO100-400V3-50Hz-MARINE, SO100-440V3-60Hz-MARINE, SO120		

rinse arm shafts



GEV No.	510318	Ref. No.	33460 340499 H340499
description	rinse arm shaft		
For models:	C98, CA120, CA55, CA90, CAP7, CAP7E, ED550, ED650E, ED650S, LO62, RCA1100, RCA1200, RCA1200i, SO55, SO55-400V3-50Hz-MARINE, SO55-440V3-60Hz-MARINE, SO55E		



GEV No.	512066	Ref. No.	18825
description	rinse arm shaft		
For models:	C53, C53D, C60, C60D, DP45, DP45D, DP50, DP50D, SP45, SP45D, SP50, SP50-400V, SP50-440V, SP50D, STS43, STS43D, STS48, STS48D, STS53, STS53D, STS60, STS60D		



GEV No.	512210	Ref. No.	34997
description	rinse arm shaft		
For models:	C81, C81E, C81EBT, C90, C90DE, C90E, C90EBT, DP35-2, DP35D-2, DP40-2, DP40D-2, DP40D-rib2, DP40-rib2, EDI13, EDI13ALTA, EDI6, EDI8, GS-X1021-2, GS-X1021-2rib, GS-X1021-WEH-2, GS-X1021-WEH-2rib, LO134, LO134ALTA, LO50, LO50E, LO67, LO83, RLO200, RLO300, RLO400, RLO50, SMW15, SMW15E, SP81, SP81E, ST43DE, ST43E, ST48DE, ST48E, ST48EBT, STS43-2, STS43D-2, STS48-2, STS48D-2, STS48D-rib2, STS48-rib2, TDN4-2rib, US-X501		



GEV No.	512238	Ref. No.	17917 34351
description	rinse arm shaft		
For models:	APS43, APS48, APS48B, APS53, APS60, APSE43, APSE48, APSE53, APSE60, C3, C4, C53, C53D, C60, C60D, DP35, DP35D, DP40, DP40D, DP45, DP45D, DP50, DP50D, FW35, FW40, FW40B, FW45, FW50, SP45, SP45D, SP50, SP50-400V, SP50-440V, SP50D, STS43, STS43D, STS48, STS48D, STS53, STS53D, STS60, STS60D		



GEV No.	512251	Ref. No.	251200 32403
description	rinse arm shaft		
For models:	APS43, APS48, APS48B, APS53, APS60, APSE43, APSE48, APSE53, APSE60, EDI13ALTABT, EDI13BT, EDI6BT, EDI8BT, FW35, FW40, FW40B, FW45, FW50, HD130BT, HG2LR, HGLR		



GEV No.	512261	Ref. No.	33699
description	rinse arm shaft		
For models:	C35, C43, C43ALTA, C43D, C48, C48D, C48DDL, C48DL, GS-X1011, GS-X1011-WEH, SP35, SP35ALTA, SP35D, SP40, SP40D, SP40DDL, SP40DL, SPB35		

Зип Общепит

vsezip.ru

+7(812)98708-81



Зип Общепит
vsezip.ru
+7(812)987-08-81

			
1			
GEV No.	512292	Ref. No.	15243
description	rinse arm shaft mounting pos. lower		
For models:	T3-80, T4-80, T6-80		

			
1			
GEV No.	512255	Ref. No.	34375
description	rinse arm shaft mounting pos. upper		
For models:	C35, C43, C43D, C48, C48D, SP35, SP35D, SP40, SP40D, SPB35		

			
1			
GEV No.	512018	Ref. No.	34384
description	rinse arm shaft mounting pos. upper/lower ø 16mm thread M10L L 38mm		
For models:	60BT, 60BT-3, C53, C53D, C60, C60D, C81, C90, DP35, DP35D, DP40, DP40D, DP45, DP45D, DP50, DP50D, DP50D-115V, GS-X1021, GS-X1021-WEH, LOS0, RSP50, RSP50A, SD5BT, SP45, SP45D, SP50, SP50-400V, SP50-440V, SP50D, SP81, STS43, STS43D, STS48, STS48D, STS53, STS53D, STS60, STS60D, TN-TDN5, TN-TDN6, US-X501, VS-X313, VS-X313-LP-DOS, VS-X515, VS-X515-LP-DOS		

knobs

producer-specific knobs

HOONVED

			
1			
GEV No.	111397	Ref. No.	25097 26668 26669
description	knob ø 43.5mm shaft ø 6.5mm brown L 32mm		
For models:	CM43, CM48, CM60, CMD43, CMD48, CMD52, CMD60, K80F, K80G		

			
1			
GEV No.	110093	Ref. No.	450323 H450323
description	knob switch zero mark t.max.°C ø 42mm shaft ø 5x5mm shaft flat black		
For models:	C98, EDI5, HG2LR, HGLR, LO61, LO62		

			
GEV No.	110062	Ref. No.	H180111
description	knob switch zero mark t.max.°C ø 45mm shaft ø 5x5mm shaft flat black		
For models:	EDT100, EDT140, EDT170, EDT200, EDT230, EDT85, TR100, TR140, TR170, TR200, TR90, TR-E100, TR-E150, TR-E170, TR-E200, TR-E230, TR-E90		

accessories

button springs

			
1			
GEV No.	111497	Ref. No.	25828
description	knob spring L 17mm W 6.3mm H 8.3mm thickness 0.6mm Qty 1 pcs		
For models:	CM43, CM48, CM52, CM60, CMD43, CMD48, CMD52, CMD60, K80F, K80G		

rosettes

			
1			
GEV No.	110105	Ref. No.	191040 H191040
description	rosette knob ø 42mm ø 56mm zero mark		
For models:	60EBT, AC101, AC151, AC181, AC201, AC241, AC91, C35E, C43DE, C43E, C46DE, C46E, C53DE, C53E, C60DE, C60E, C68DE, C68E, C68EBT, C6DE, C6E, C6EBT, C90DE2, C90E2, C90EBT2, CA55, CAP7, CAP7E, DP45DE, DP45E, DP50DE, DP50E, DP50EBT, ED550, EDT100, EDT140, EDT170, EDT200, EDT230, EDT85, HD130BT, HD40ALTABT, HD40BT, HD60BT, HD80BT, HT100, HT150, RCA1100, RCA1200, RCA1200i... (Other models you can see in the webshop)		

handles and hand wheels

handle rails

handle rails

			
1			
GEV No.	510454	Ref. No.	170806 H170806
description	handle rail L 480mm W 52mm H 20mm Qty 1 pcs		

Зип-Общепит
equipment feet with stem

mechanical components, equipment accessories

locks

snap locks

producer-specific

HOONVED



GEV No.	692100	Ref. No.	180508 37198
description	snap lock L 36mm ø 17mm		
For models:	60EBT, C60DE, C60E, C6DE, C6E, C6EBT, SP50DE, SP50E		

GEV No.	701046	Ref. No.	210404 H210404
description	equipment foot push-in ø 35mm H 5mm mounting ø 9.5mm overall height 19mm rubber Qty 1 pcs		
For models:	AC101, AC151, AC181, AC201, AC241, AC91, EDT100, EDT140, EDT170, EDT200, EDT230, EDT85, TR100, TR140, TR170, TR200, TR230, TR90		

miscellaneous



GEV No.	701044	Ref. No.	341016 H341016
description	angle piece for catch hook L 54mm W 27mm H 8.5mm		
For models:	AC101, AC151, AC181, AC201, AC241, AC91, EDT100, EDT140, EDT170, EDT200, EDT230, EDT85, TR100, TR140, TR170, TR200, TR230, TR90, TR-E100, TR-E150, TR-E170, TR-E200, TR-E230, TR-E90		

baskets

warewashing baskets

steel wire baskets round

mix baskets



GEV No.	970519	Ref. No.	15412
description	mix basket ED ø 355mm H 190mm seat ø 280mm		

GEV No.	970312	Ref. No.	15414
description	mix basket ED ø 405mm H 160mm seat ø 280mm		
For models:	CM48, CMD48, NK48, NKD48		

GEV No.	970520	Ref. No.	15417
description	mix basket ED ø 455mm H 160mm seat ø 390mm		
For models:	CM52, CMD52, E50, NK52, NKD52		

equipment feet and end caps

equipment feet

with fixing plate



GEV No.	504350	Ref. No.	602222 H620222
description	equipment foot for dishwasher L 135-230mm		
For models:	EDT100, EDT140, EDT170, EDT200, EDT230, EDT85, TR100, TR140, TR170, TR200, TR230, TR90		

screw-in feet



GEV No.	691652	Ref. No.	25209
description	equipment foot thread M10 thread L 25mm H 8mm ø 25mm overall height 33mm WS 25 Qty 1 pcs		
For models:	60BT, 60BT-3, 60EBT, AP43E, AP48E, AP53E, AP60E, APS43, APS48, APS48B, APS53, APS60, APSE43, APSE48, APSE53, APSE60, C3, C35, C35E, C4, C43, C43-2, C43ALTA, C43D, C43DE, C43E, C46DE, C46E, C48, C48-2, C48D, C48D-2, C48DDL, C48DL, C48E, C53, C53D, C53DE, C53E, C6, C60, C60D, C60DE, C60E, C68DE, C68E, C68EBT, C6D, C6DE, C6E... (Other models you can see in the webshop)		



Зип Общепит

vsezip.ru
GEV

+7(812)947-08-81

plastic baskets round



GEV No.	970518	Ref. No.	25132
description	mix basket ED ø 360mm H 130mm seat ø 280mm mesh type wide-meshed/plastic		
For models:	CM43, CM52, CMD43, E36, E40, E43, NK43, NK52, NKD43		



GEV No.	970319	Ref. No.	660703 H660703
description	mix basket ED ø 380mm H 160mm seat ø 365mm mesh type close-meshed/plastic		

accessories

cutlery inserts



GEV No.	970349	Ref. No.	15464
description	cutlery insert L 130mm W 57mm ømm H 110mm		



GEV No.	976017	Ref. No.	15465
description	cutlery insert L 150mm W 130mm ømm H 110mm plastic		
For models:	CM52, CM60, CMD52, E50, ED650E-90, ED650S, ED650S-90, K80F, K80G, M60, NK52, NK60, NKD52, T5-80, T6-80		

basket holders



GEV No.	971146	Ref. No.	37807
description	basket support L 585mm W 530mm for basket 500x500mm suitable for CAP7 stainless steel		
For models:	CAP7E, SO55E		
accessories for	971146		



GEV No.	524465	Ref. No.	36465
----------------	--------	-----------------	-------

roller plastic for basket holder ø 34mm

GEV No.	970055	Ref. No.	H660803
description	pin for dishwasher rack		



GEV No.	970056	Ref. No.	H660804
description	pin for dishwasher rack		



GEV No.	524465	Ref. No.	36465
description	roller plastic for basket holder ø 34mm		
For models:	CAP7, CAP7E, SO55, SO55-400V3-50Hz-MARINE, SO55-440V3-60Hz-MARINE, SO55E		

gaskets

O-rings

EPDM



GEV No.	510302	Ref. No.	29670 H200823 H200824
description	O-ring EPDM ID ø 12.42mm thickness 1.78mm Qty 1 pcs		
For models:	AP43E, AP48E, AP53E, AP60E, APS43, APS48, APS48B, APS53, APS60, APSE43, APSE48, APSE53, APSE60, BPS43, BPS52, C68DE, C68E, E40-2F, EDT100, EDT140, EDT85, FW35, FW35E, FW40, FW40B, FW40E, FW45, FW50, INDY43F, INDY48F, INDY53F, INDY60F, SP68DE, SP68E, TR100, TR140, TR90, TR-E100, TR-E150, TR-E170, TR-E200, TR-E230, TS43, TS48, UNI43C, UNI48C, UNI48CD, UNI53C, UNI60C		



GEV No.	504512	Ref. No.	25243 H200826
description	O-ring EPDM thickness 1.78mm ID ø 14mm Qty 1 pcs		
For models:	BPN48, BPS43, BPS52, E40, E40-2F, E43, E50, INDY43F, INDY48F, INDY53F, INDY60F, TS43, TS48, UNI43C, UNI48C, UNI48CD, UNI53C, UNI60C		

Зип Общепит

vsezip.ru

+7(812)987-08-81



GEV No.	528243	Ref. No.	32831
description	O-ring EPDM thickness 1.78mm ID ø 15.6mm Qty 1 pcs		
For models:	60BT, 60BT-3, 60EBT, AP43E, AP48E, AP53E, AP60E, APS43, APS48, APS48B, APS53, APS60, APSE43, APSE48, APSE53, APSE60, BPN48, BPS43, BPS52, C3, C35, C35E, C4, C43, C43-2, C43ALTA, C43D, C43DE, C43E, C46DE, C46E, C48, C48-2, C48D, C48D-2, C48DDL, C48DL, C48E, C53, C53D, C53DE, C53E, C6, C60, C60D, C60DE, C60E, C68DE, C68E, C68EBT...(Other models you can see in the webshop)		



GEV No.	530293	Ref. No.	H200809
description	O-ring EPDM thickness 1.78mm ID ø 8.73mm Qty 1 pcs		
For models:	EDI13, EDI13-2, EDI13ALTA, EDI13ALTA-2, EDI13ALTABT, EDI13BT, EDI4, EDI6, EDI6-2, EDI6BT, EDI8, EDI8-2, EDI8BT, EDT100, EDT140, EDT170, EDT200, EDT230, EDT85, LO134, LO134-2, LO134ALTA, LO134ALTA-2, LO56, LO67, LO67-2, LO83, LO83-2, RLO200, RLO300, RLO400, TR100, TR140, TR170, TR200, TR230, TR90, TR-E100, TR-E150, TR-E170, TR-E200, TR-E230, TR-E90		

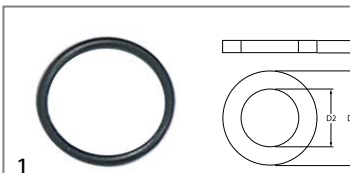

GEV No.	510322	Ref. No.	27050
description	O-ring EPDM thickness 1.78mm ID ø 17.17mm Qty 1 pcs		
For models:	C35, C35E, C43, C43-2, C43ALTA, C43D, C43DE, C43E, C46DE, C46E, C48, C48-2, C48D, C48D-2, C48DDL, C48DL, C48E, C6, C6D, C6DE, C6E, C6EBT, E40-2F, ED600-95, ED700-90, ED900-90, EDI5, GS-X1011, GS-X1011-2, GS-X1011-WEH, GS-X1011-WEH-2, INDY43F, INDY48F, INDY53F, INDY60F, K80F, LO122, LO60, LO61, LO78, RSP40, RSP40A, SP35, SP35-2, SP35ALTA, SP35D, SP35DE, SP35E, SP40, SP40-2...(Other models you can see in the webshop)		

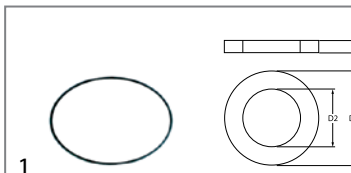

GEV No.	510556	Ref. No.	35497
description	O-ring EPDM thickness 1.78mm ID ø 94.97mm Qty 1 pcs pump type T110		
For models:	C35E, C43-2, C43DE, C43E, C46DE, C46E, C48-2, C48D-2, C48E, C68DE, C68E, C68EBT, DP35-2, DP35D-2, DP40-2, DP40D-2, DP40D-rib2, DP40-rib2, GS-X1011-2, GS-X1011-WEH-2, GS-X1021-2, GS-X1021-2rib, GS-X1021-WEH-2, GS-X1021-WEH-2rib, RSP40, RSP40A, SP35-2, SP35DE, SP35E, SP40-2, SP40D-2, SP40DE, SP40E, SP68DE, SP68E, SPB35E, ST43DE, ST43E, ST48DE, ST48E, ST48EBT, STS43-2, STS43D-2, STS48-2, STS48D-2, STS48D-rib2, STS48-rib2, TDN4-2rib		

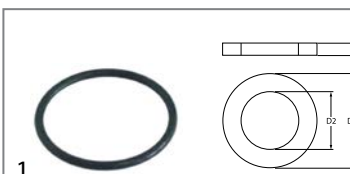

GEV No.	517045	Ref. No.	28224
description	O-ring EPDM thickness 1.78mm ID ø 21.95mm Qty 1 pcs		

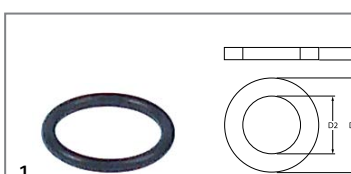

GEV No.	511237	Ref. No.	34360
description	O-ring EPDM thickness 1mm ID ø 7mm Qty 1 pcs		
For models:	60BT, 60BT-3, 60EBT, AP43E, AP48E, AP53E, AP60E, APS43, APS48, APS48B, APS53, APS60, C35, C43, C43D, C48, C48D, C53, C53D, C53DE, C53E, C60, C60D, C60DE, C60E, C68DE, C68E, C68EBT, C81, C90, CAP10, CAP10BT, CAP10DE, CAP7, CAP7E, DP35, DP35-2, DP35D, DP35D-2, DP40, DP40-2, DP40D, DP40D-2, DP40D-rib2, DP40-rib2, DP45, DP45D, DP45DE, DP45E, DP50...(Other models you can see in the webshop)		



GEV No.	510303	Ref. No.	31014 456030 H200818
description	O-ring EPDM thickness 1.78mm ID ø 6.75mm Qty 1 pcs		
For models:	APS43, APS48, APS48B, APS53, APS60, BPS43, C68DE, C68E, C81E, C81EBT, C90, C90DE, C90DE2, C90E, C90E2, C90EBT, C90EBT2, C98, CA120, CA55, CA90, ED550, ED650E, ED650S, FW35, FW40, FW40B, FW45, FW50, LO50, LO50E, LO62, RCA1100, RCA1200, RCA1200i, RLO50, SMW15, SMW15E, SP68DE, SP68E, SP81E, TS43, TS48, US-X501		

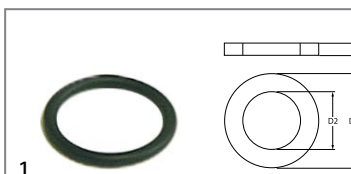

GEV No.	511191	Ref. No.	200813
description	O-ring EPDM thickness 2.21mm ID ø 16.36mm Qty 1 pcs		
For models:	C68DE, C68E, C68EBT, CAP15EBT, HD130BT, HD40ALTABT, HD40BT, HD60BT		

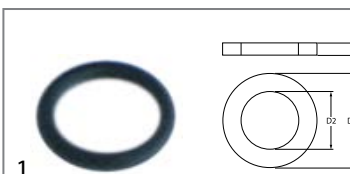

GEV No.	510177	Ref. No.	30475
description	O-ring EPDM thickness 1.78mm ID ø 7.66mm Qty 1 pcs		
For models:	BPS43, BPS52, E40-2F, INDY43F, INDY48F, INDY53F, INDY60F, TS43, TS48, UNI43C, UNI48C, UNI48CD, UNI53C, UNI60C		



Зип Общепит
vsezip.ru
+7(812)987-08-81



GEV No.	505310	Ref. No.	32589
description	O-ring EPDM thickness 2.62mm ID ø 17.62mm Qty 1 pcs		
For models:	APS43, APS48, APS48B, APS53, APS60, APSE43, APSE48, APSE53, APSE60, BPN48, BPS43, BPS52, FW35, FW40, FW40B, FW45, FW50		

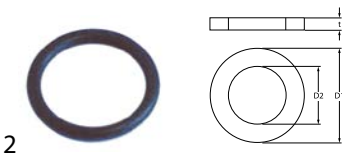

GEV No.	507309	Ref. No.	33798
description	O-ring EPDM thickness 2.62mm ID ø 17.13mm Qty 1 pcs		
For models:	CDN3, CDN4, CR43, CR43D, CR48, CR48D, SPR36, SPR36D, SPR41, SPR41D		

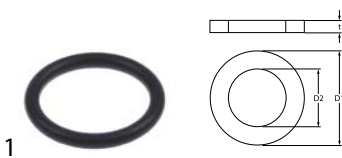

GEV No.	516026	Ref. No.	25242
description	O-ring EPDM thickness 2.62mm ID ø 17.86mm Qty 1 pcs		

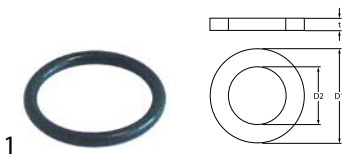

GEV No.	505073	Ref. No.	34332
description	O-ring EPDM thickness 2.62mm ID ø 20.63mm Qty 1 pcs		
For models:	60BT, 60BT-3, 60EBT, C35E, C43-2, C43ALTA, C43DE, C43E, C46DE, C46E, C48-2, C48D-2, C48DDL, C48DL, C48E, C53, C53D, C53DE, C53E, C60, C60D, C60DE, C60E, C68DE, C68E, C68EBT, C6DE, C6E, C6EBT, C81, C81E, C81EBT, C90, C90DE, C90E, C90EBT, C98, DP35, DP35-2, DP35D, DP35D-2, DP40, DP40-2, DP40D, DP40D-2, DP40D-rib2, DP40-rib2, DP45, DP45D, DP45DE...(Other models you can see in the webshop)		

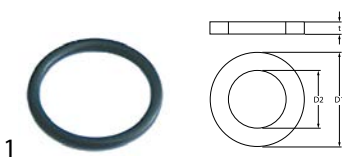

GEV No.	512071	Ref. No.	25238
description	O-ring EPDM thickness 2.62mm ID ø 22.22mm Qty 1 pcs		
For models:	APS43, APS48, APS53, APS60, APSE43, APSE48, APSE53, APSE60, C3, C4, E40, E40-2F, ED650S-90, INDY43F, INDY48F, INDY53F, INDY60F, UNI43C, UNI48C, UNI48CD, UNI53C, UNI60C		



GEV No.	502036	Ref. No.	200805 25239
description	O-ring EPDM thickness 2.62mm ID ø 28.25mm Qty 1 pcs		
For models:	60BT, 60BT-3, 60EBT, AP43E, AP48E, AP53E, AP60E, APS43, APS48, APS48B, APS53, APS60, APSE43, APSE48, APSE53, APSE60, BPN48, BPS43, BPS52, C3, C35, C35E, C4, C43, C43-2, C43ALTA, C43D, C43DE, C43E, C46DE, C46E, C48, C48-2, C48D, C48D-2, C48DDL, C48DL, C48E, C53, C53D, C53DE, C53E, C6, C60, C60D, C60DE, C60E, C68DE, C68E, C68EBT...(Other models you can see in the webshop)		

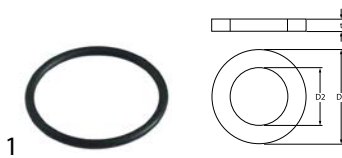

GEV No.	517104	Ref. No.	31639
description	O-ring EPDM thickness 2.62mm ID ø 31.42mm Qty 1 pcs		
For models:	E40-2F, INDY43F, INDY48F, INDY53F, INDY60F, TS48, UNI43C, UNI48C, UNI48CD, UNI53C, UNI60C		

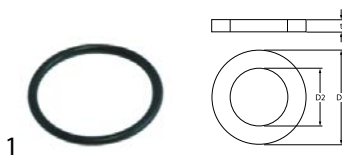

GEV No.	512111	Ref. No.	28226
description	O-ring EPDM thickness 2.62mm ID ø 45.69mm Qty 1 pcs		
For models:	60BT, 60BT-3, 60EBT, AP43E, AP48E, AP53E, AP60E, APS43, APS48, APS48B, APS53, APS60, APSE43, APSE48, APSE53, APSE60, BPN48, BPS43, BPS52, C3, C35, C35E, C4, C43, C43-2, C43ALTA, C43D, C43DE, C43E, C46DE, C46E, C48, C48-2, C48D, C48D-2, C48DDL, C48DL, C48E, C53, C53D, C53DE, C53E, C6, C60, C60D, C60DE, C60E, C68DE, C68E, C68EBT...(Other models you can see in the webshop)		



GEV No.	512056	Ref. No.	32310
description	O-ring EPDM thickness 2.62mm ID ø 50.47mm Qty 1 pcs		
For models:	60BT, 60BT-3, APS43, APS48, APS48B, APS53, APS60, APSE43, APSE48, APSE53, APSE60, C3, C35, C4, C43, C43ALTA, C43D, C48, C48D, C48DDL, C48DL, C53, C53D, C60, C60D, DP35, DP35D, DP40, DP40D, DP45, DP45D, DP50, DP50D, DP50D-115V, FW35, FW40, FW40B, FW45, FW50, GS-X1011, GS-X1011-WEH, GS-X1021, GS-X1021-WEH, RSP50, RSP50A, SD58T, SP35, SP35ALTA, SP35D, SP40...(Other models you can see in the webshop)		

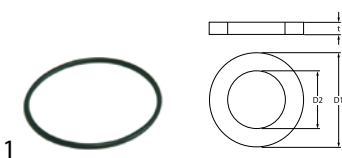

1

GEV No.	512114	Ref. No.	31557
description	O-ring EPDM thickness 2.62mm ID \varnothing 55.25mm Qty 1 pcs		
For models:	E40-2F, INDY43F, INDY48F, UNI43C, UNI48C, UNI48CD, UNI53C, UNI60C		



1

GEV No.	528583	Ref. No.	33792
description	O-ring EPDM thickness 2.62mm ID \varnothing 9.13mm Qty 1 pcs		
For models:	C35, C35E, C43, C43-2, C43ALTA, C43D, C43DE, C43E, C46DE, C46E, C48, C48-2, C48D, C48D-2, C48DDL, C48DL, C48E, C6, C6D, C6DE, C6E, C6EBT, CDN3, CDN4, CR43, CR43D, CR48, CR48D, GS-X1011, GS-X1011-2, GS-X1011-WEH, GS-X1011-WEH-2, RSP40, RSP40A, SP35, SP35-2, SP35ALTA, SP35D, SP35DE, SP35E, SP40, SP40-2, SP40D, SP40D-2, SP40DDL, SP40DE, SP40DL, SP40E, SP5, SP5D...(Other models you can see in the webshop)		

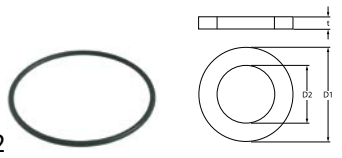

2

GEV No.	505311	Ref. No.	31386
description	O-ring EPDM thickness 2.62mm ID \varnothing 67.95mm Qty 1 pcs		
For models:	BPN48, BPS43, BPS52, CAP10, CAP12, ED600-95, ED700-90, ED900-90, EDI5, LO122, LO60, LO61, LO78, SO100, SO120		



1

GEV No.	510901	Ref. No.	H200843
description	O-ring EPDM thickness 2mm ID \varnothing 13mm Qty 1 pcs		
For models:	C35, C35E, C43, C43-2, C43ALTA, C43D, C43DE, C43E, C46DE, C46E, C48, C48-2, C48D, C48D-2, C48DDL, C48DL, C48E, C6, C6D, C6DE, C6E, GS-X1011, GS-X1011-2, GS-X1011-WEH, GS-X1011-WEH-2, RSP40, RSP40A, SP35, SP35-2, SP35ALTA, SP35D, SP35DE, SP35E, SP40, SP40-2, SP40D, SP40D-2, SP40DDL, SP40DE, SP40DL, SP40E, SP5, SP5D, SP5DE, SP5E, SPB35, SPB35E		

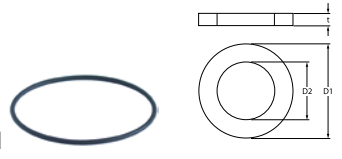

1

GEV No.	511395	Ref. No.	25245
description	O-ring EPDM thickness 2.62mm ID \varnothing 71.12mm Qty 1 pcs		
For models:	APS43, APS48, APS48B, APS53, APS60, APSE43, APSE48, APSE53, APSE60, C35, C43, C43ALTA, C43D, C48, C48D, C48DDL, C48DL, C53, C53D, C60, C60D, CM43, CM48, CM52, CM60, CR43, CR43D, CR48, CR48D, DP35, DP35-2, DP35D, DP35D-2, DP40, DP40-2, DP40D, DP40D-2, DP40D-rib2, DP40-rib2, DP45, DP45D, DP50, DP50D, FW35, FW40, FW40B, FW45, FW50, GS-X1021-2, GS-X1021-2rib...(Other models you can see in the webshop)		

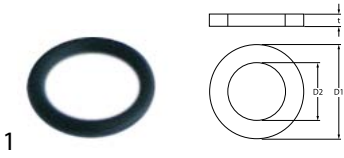

1

GEV No.	510902	Ref. No.	33790
description	O-ring EPDM thickness 2mm ID \varnothing 9.5mm Qty 1 pcs		
For models:	C35, C35E, C43, C43-2, C43ALTA, C43D, C43DE, C43E, C46DE, C46E, C48, C48-2, C48D, C48D-2, C48DDL, C48DL, C48E, C6, C6D, C6DE, C6E, C6EBT, C81, C81E, C81EBT, C90, C90DE, C90E, C90EBT, CDN3, CDN4, CR43, CR43D, CR48, CR48D, EDI13, EDI13ALTA, EDI6, EDI8, GS-X1011, GS-X1011-2, GS-X1011-WEH, GS-X1011-WEH-2, LO134, LO134ALTA, LO50, LO50E, LO67, LO83, RLO200...(Other models you can see in the webshop)		

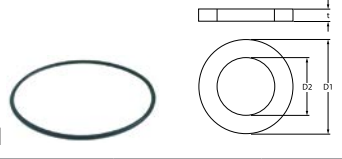

1

GEV No.	528800	Ref. No.	33183 34224
description	O-ring EPDM thickness 2.62mm ID \varnothing 75.87mm Qty 1 pcs		
For models:	C3, C35, C4, C43, C43D, C48, C48D, C98, CDN3, CDN4, CR43, CR43D, CR48, CR48D, EDI13, EDI13-2, EDI13ALTA, EDI13ALTA-2, EDI6, EDI6-2, EDI8, EDI8-2, HD130BT, HD60BT, HD80BT, LO134, LO134-2, LO134ALTA, LO134ALTA-2, LO62, LO67, LO67-2, LO83, LO83-2, RLO200, RLO300, RLO400, SMW15E, SP35, SP35D, SP40, SP40D, SPB35, SPR36, SPR36D, SPR41, SPR41D		

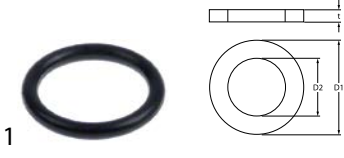

1

GEV No.	511322	Ref. No.	200869 30479
description	O-ring EPDM thickness 3.53mm ID \varnothing 20.22mm Qty 1 pcs		
For models:	60EBT, AP53E, AP60E, C35E, C43-2, C43ALTA, C43DE, C43E, C46DE, C46E, C48-2, C48D-2, C48DDL, C48DL, C48E, C53, C53D, C53DE, C53E, C60DE, C60E, C68DE, C68E, C68EBT, C6DE, C6E, C6EBT, DP35, DP35-2, DP35D, DP35D-2, DP40, DP40-2, DP40D, DP40D-2, DP40D-rib2, DP40-rib2, DP45, DP45D, DP45DE, DP45E, DP50DE, DP50E, DP50EBT, ED700-90, ED900-90, GS-X1011, GS-X1011-2, GS-X1011-WEH, GS-X1011-WEH-2...(Other models you can see in the webshop)		

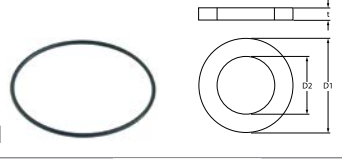

1

GEV No.	512235	Ref. No.	31057 31784
description	O-ring EPDM thickness 2.62mm ID \varnothing 88.57mm Qty 1 pcs		
For models:	APS43, APS48, APS48B, APS53, APS60, APSE43, APSE48, APSE53, APSE60, C53, C53D, C60, C60D, DP35, DP35D, DP40, DP40D, DP45, DP45D, DP50, DP50D, FW35, FW40, FW40B, FW45, FW50, INDY43F, INDY48F, INDY53F, INDY60F, SP45, SP45D, SP50, SP50-400V, SP50-440V, SP50D, STS43, STS43D, STS48, STS48D, STS53, STS53D, STS60, STS60D, TS48, UNI43C, UNI48C, UNI48CD, UNI53C, UNI60C		



Зип Общепит

vsezip.ru

+7(812)987-08-81



GEV No.	511521	Ref. No.	30344
description	O-ring EPDM thickness 3.53mm ID ø 28.17mm Qty 10 pcs		
For models:	BPN48, BPS43, BPS52		



GEV No.	521120	Ref. No.	25249
description	O-ring EPDM thickness 5.34mm ID ø 37.47mm Qty 1 pcs		

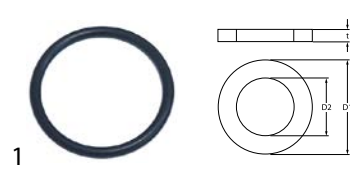

GEV No.	510899	Ref. No.	200830 H200830
description	O-ring EPDM thickness 3.53mm ID ø 37.69mm Qty 1 pcs		
For models:	AC101, AC151, AC181, AC201, AC241, AC91, EDT100, EDT140, EDT170, EDT200, EDT230, EDT85, TR100, TR140, TR170, TR200, TR230, TR90, TR-E100, TR-E150, TR-E170, TR-E200, TR-E230, TR-E90		

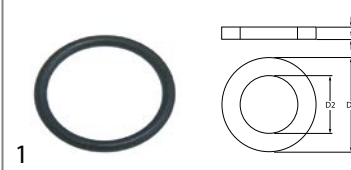

GEV No.	510408	Ref. No.	200820 8662
description	O-ring EPDM thickness 5.34mm ID ø 47mm Qty 1 pcs		
For models:	60EBT, AP43E, AP48E, C35E, C43DE, C43E, C46DE, C46E, C53DE, C53E, C6, C60DE, C60E, C68DE, C68E, C68EBT, C6D, C6DE, C6E, C6EBT, DP45DE, DP45E, DP50DE, DP50E, DP50EBT, FW35E, FW40E, SP35DE, SP35E, SP40DE, SP40E, SP45DE, SP45E, SP50DE, SP50E, SPB35E, ST43DE, ST43E, ST48DE, ST48E, ST48EBT, ST53DE, ST53E, ST60DE, ST60E, ST60EBT		

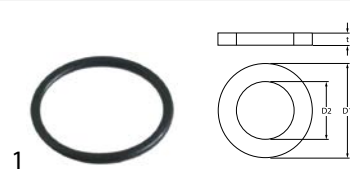

GEV No.	506015	Ref. No.	25246
description	O-ring EPDM thickness 3.53mm ID ø 39.69mm Qty 1 pcs		
For models:	C43D, C43DE, C46DE, C46E, C48D, C48D-2, C48DDL, C48E, C53D, C53DE, C60D, C60DE, C68DE, C68E, C6D, C6DE, C90DE, C90DE2, CDN3, CDN4, CMD43, CMD48, CMD52, CMD60, CR43D, CR48D, DP35D, DP35D-2, DP40D, DP40D-2, DP40D-rib2, DP45D, DP45DE, DP50D, DP50D-115V, DP50DE, GS-X1011, GS-X1011-2, GS-X1011-WEH, GS-X1011-WEH-2, GS-X1021, GS-X1021-2, GS-X1021-2rib, GS-X1021-WEH, GS-X1021-WEH-2, GS-X1021-WEH-2rib, NKD43, NKD48, NKD52, NKD60...(Other models you can see in the webshop)		

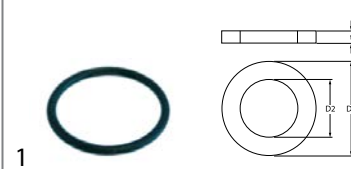

GEV No.	510409	Ref. No.	200815 33402 H200815
description	O-ring EPDM thickness 5.34mm ID ø 56.52mm Qty 1 pcs		
For models:	60BT, 60BT-3, 60EBT, AC101, AC151, AC181, AC201, AC241, AC91, AP53E, AP60E, APS43, APS48, APS48B, APS53, APS60, C53, C53D, C53DE, C53E, C60, C60D, C60DE, C60E, C68DE, C68E, C68EBT, C6DE, C6E, C6EBT, C81, C81E, C81EBT, C90, C90DE, C90DE2, C90E, C90E2, C90EBT, C90EBT2, C98, CA120, CA55, CA90, CAP10, CAP10BT, CAP10DE, CAP12, CAP12DE, CAP12EBT...(Other models you can see in the webshop)		



GEV No.	528192	Ref. No.	200842 31948
description	O-ring EPDM thickness 3mm ID ø 56mm Qty 1 pcs		
For models:	60EBT, AP43E, AP48E, AP53E, AP60E, APS43, APS48, APS48B, APS53, APS60, APSE43, APSE48, APSE53, APSE60, BPN48, BPS43, BPS52, C35E, C43-2, C43DE, C43E, C46DE, C46E, C48-2, C48D-2, C48E, C53DE, C53E, C60DE, C60E, C68DE, C68E, C68EBT, C6DE, C6E, C6EBT, DP35-2, DP35D-2, DP40-2, DP40D-2, DP40D-rib2, DP40-rib2, DP45DE, DP45E, DP50DE, DP50E, DP50EBT, FW35, FW35E, FW40...(Other models you can see in the webshop)		

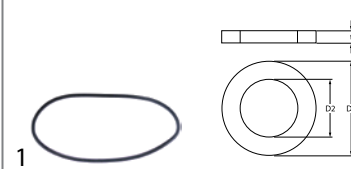

GEV No.	510551	Ref. No.	26223 27066 33855
description	pump cover gasket ID ø 158.3mm pump type 1214/1293/1225/2243/1226/1204/3473/1241 thickness 3.53mm EPDM Qty 1 pcs		
For models:	C81, C81E, C81EBT, C90, C90DE, C90DE2, C90E, C90E2, C90EBT, C90EBT2, C98, CA120, CA55, CA90, CAP10, CAP10BT, CAP10DE, CAP12, CAP12DE, CAP12EBT, CAP7, CAP7E, ED550, ED600-95, ED630-90, ED650E, ED650E-90, ED650S, ED650S-90, ED700, ED900-90, ED113, ED113-2, ED113ALTA, ED113ALTA-2, ED113ALTABT, ED113BT, EDI4, EDI5, EDI6, EDI6-2, EDI6BT, EDI8, EDI8-2, EDI8BT, HD130BT, HD40ALTABT, HD40BT, HD60BT, HD80BT...(Other models you can see in the webshop)		



GEV No.	524483	Ref. No.	200807
description	O-ring EPDM thickness 4mm ID ø 110mm Qty 1 pcs		
For models:	C90DE2, C90E2, C90EBT2, CAP10, CAP10DE, CAP12, CAP12DE, CAP12EBT, CAP15EBT, CAP7E, EDI4, HD40ALTABT, HD40BT, HT150, HTP195, HTP205, HTP220		

NBR



GEV No.	532720	Ref. No.	200878
description	O-ring NBR ID ø 17.86mm thickness 2.62mm Qty 1 pcs		
For models:	HT100, HT150, HTP195, HTP205, HTP220		

sealing washers

fibre gaskets



GEV No.	504431	Ref. No.	25274 460535
description	flat gasket FIBER ED ø 12mm ID ø 6mm thickness 2mm Qty 1 pcs		
For models:	AP43E, AP48E, AP53E, AP60E, APS43, APS48, APS48B, APS53, APS60, APSE43, APSE48, APSE53, APSE60, BPN48, BPS43, BPS52, C3, C35, C35E, C4, C43, C43-2, C43ALTA, C43D, C43DE, C43E, C46DE, C46E, C48, C48-2, C48D, C48D-2, C48DDL, C48DL, C48E, C53, C53D, C6, C60, C60D, C6D, CDN3, CDN4, CM43, CM48, CM52, CM60, CMD43, CMD48, CMD52...(Other models you can see in the webshop)		



GEV No.	503003	Ref. No.	32520
description	flat gasket FIBER ED ø 27mm ID ø 21mm thickness 2mm Qty 1 pcs		
For models:	ED600-95, ED700-90, ED900-90, EDI5, LO122, LO60, LO61, LO78		



GEV No.	510996	Ref. No.	H460502
description	flat gasket FIBER ED ø 31mm ID ø 21.5mm thickness 2mm for thread 1/2" Qty 1 pcs		
For models:	C90, C90DE, C90E, C90EBT, C98, CA120, CA55, CA90, CAP10, CAP10BT, CAP12, CAP7, CAP7E, ED550, ED650E, ED650S, EDI13-2, EDI13ALTA-2, EDI13ALTABT, EDI13BT, EDI6-2, EDI6BT, EDI8-2, EDI8BT, EDT100, EDT140, EDT170, EDT200, EDT230, EDT85, LO134-2, LO134ALTA-2, LO50, LO50E, LO62, LO67-2, LO83-2, RCA1100, RCA1200, RCA1200i, RLO50, SMW15, SMW15E, SO100, SO100-400V3-50Hz-MARINE, SO100-440V3-60Hz-MARINE, SO120, SO55, SO55-400V3-50Hz-MARINE, SO55-440V3-60Hz-MARINE...(Other models you can see in the webshop)		

Зип Общепит

vsezip.ru

+7(812)987-08-81



GEV No.	510355	Ref. No.	33372 460501
description	gasket fibre ED ø 24mm ID ø 17mm thickness 2mm Qty 1 pcs		
For models:	AC101, AC151, AC181, AC201, AC241, AC91, C81, C81E, C81EBT, C90, C90DE, C90E, C90EBT, C98, CA120, CA55, CA90, CAP7, CAP7E, ED550, ED650E, ED650S, EDI13, EDI13-2, EDI13ALTA, EDI13ALTA-2, EDI6, EDI8, EDI8-2, EDT100, EDT140, EDT170, EDT200, EDT230, EDT85, LO134, LO134-2, LO134ALTA, LO134ALTA-2, LO50, LO50E, LO62, LO67, LO83, LO83-2, RCA1100, RCA1200, RCA1200i, RLO300, RLO400...(Other models you can see in the webshop)		

rubber gaskets



GEV No.	505313	Ref. No.	200482 33453
description	flat gasket Neoprene ED ø 50mm ID ø 35mm thickness 4mm Qty 1 pcs		
For models:	C81, C81E, C81EBT, C90, C90DE, C90DE2, C90E, C90E2, C90EBT, C90EBT2, C98, CA120, CA55, CA90, CAP10, CAP10BT, CAP10DE, CAP12, CAP12DE, CAP12EBT, CAP15EBT, CAP7, CAP7E, ED550, ED650E, ED650S, EDI4, HD40ALTABT, HD40BT, LO50, LO50E, LO56, LO62, RCA1100, RCA1200, RCA1200i, RLO50, SMW15, SMW15E, SO100, SO100-400V3-50Hz-MARINE, SO100-440V3-60Hz-MARINE, SO120, SO55, SO55-400V3-50Hz-MARINE, SO55-440V3-60Hz-MARINE, SO55E, SP81, SP81E, US-X501		



GEV No.	510761	Ref. No.	25263
description	flat gasket rubber D1 ø 38mm D2 ø 25mm thickness 2mm Qty 1 pcs		
For models:	60BT, 60BT-3, 60EBT, APS43, APS48, APS48B, APS53, APS60, APSE43, APSE48, APSE53, APSE60, BPN48, BPS43, BPS52, C3, C35, C35E, C4, C43, C43-2, C43ALTA, C43D, C43DE, C43E, C46DE, C46E, C48, C48-2, C48D, C48D-2, C48DDL, C48DL, C48E, C53, C53D, C53DE, C53E, C6, C60, C60D, C60DE, C60E, C68DE, C68E, C68EBT, C6D, C6DE, C6E, C6EBT...(Other models you can see in the webshop)		





GEV No.	512070	Ref. No.	25257
description	flat gasket rubber ED ø 17.5mm ID ø 13mm thickness 2mm Qty 1 pcs		
For models:	APS43, APS48, APS53, APS60, APSE43, APSE48, APSE53, APSE60, C3, C35, C4, C43, C43D, C48, C48D, C53, C53D, C60, C60D, E36, E40, E40-2F, INDY43F, INDY48F, INDY53F, INDY60F, K80F, K80G, SP35, SP35D, SP40, SP40D, SP45, SP45D, SP50, SP50D, T3-80, T4-80, T5-80, UNI43C, UNI48C, UNI48CD, UNI53C, UNI60C		





Зип Общепит
vsezip.ru

			
1			
GEV No.	512376	Ref. No.	25266
description	flat gasket rubber ED ø 18mm ID ø 10mm thickness 2mm Qty 1 pcs		
For models:	60BT, 60BT-3, 60EBT, AP43E, AP48E, AP53E, AP60E, APS43, APS18, APS48B, APS53, APS60, APSE43, APSE48, APSE53, APSE60, BPN48, BPS43, BPS52, C3, C35, C35E, C4, C43, C43-2, C43ALTA, C43D, C43DE, C43E, C46DE, C46E, C48, C48-2, C48D, C48D-2, C48DDL, C48DL, C48E, C53, C53D, C53DE, C53E, C6, C60, C60D, C60DE, C60E, C68DE, C68E, C68EBT...(Other models you can see in the webshop)		

			
1			
GEV No.	510877	Ref. No.	200415 H200415
description	flat gasket rubber ED ø 18mm ID ø 10mm thickness 3mm Qty 1 pcs		
For models:	60EBT, AC101, AC151, AC181, AC201, AC241, AC91, C53DE, C53E, C6, C60DE, C60E, C68DE, C68E, C68EBT, C6D, C6DE, C6E, C6EBT, DP45DE, DP45E, DP50DE, DP50E, DP50EBT, EDT100, EDT140, EDT170, EDT200, EDT230, EDT85, HG2LR, HGLR, SP45DE, SP45E, SP5, SP50DE, SP50E, SP50E-400V3-50Hz-MARINE, SP50E-440V3-60Hz-MARINE, SP5D, SP5DE, SP5E, SP68DE, SP68E, ST53DE, ST53E, ST60DE, ST60E, ST60EBT		

			
1			
GEV No.	511283	Ref. No.	H200927
description	flat gasket rubber ED ø 30mm ID ø 20mm thickness 2mm Qty 1 pcs		
For models:	C81E, CAP10, CAP10BT, CAP12, EDI13ALTABT, EDI13BT, EDI4, EDI5, EDI6BT, EDI8BT, EDT100, EDT140, EDT170, EDT200, EDT230, EDT85, LO56, LO61, SO100, SO100-400V3-50Hz-MARINE, SO100-440V3-60Hz-MARINE, SO120, SP81E, TR100, TR140, TR170, TR200, TR230, TR90, TR-E100, TR-E150, TR-E170, TR-E200, TR-E230, TR-E90		

			
1			
GEV No.	512073	Ref. No.	25267
description	flat gasket rubber ED ø 31mm ID ø 22mm thickness 2mm Qty 1 pcs		
For models:	E36, E40-2F, ED600-95, ED630-90, ED650S, ED650S-90, ED700-90, ED900, ED900-90, EDI13, EDI13-2, EDI13ALTA, EDI13ALTA-2, EDI6, EDI6-2, EDI8, EDI8-2, K80F, K80G, LO122, LO134, LO134-2, LO134ALTA, LO134ALTA-2, LO60, LO67, LO67-2, LO78, LO83, LO83-2, RLO200, RLO300, RLO400, T3-80, T4-80, T5-80		

			
1			
GEV No.	512346	Ref. No.	25261
description	flat gasket rubber ED ø 44mm ID ø 32mm thickness 2.5mm Qty 1 pcs		
For models:	CM43, CM48, CM52, CM60, CMD43, CMD48, CMD52, CMD60, E36, E40, E43, E50, ED600-95, ED630-90, ED650E, ED650E-90, ED650S, ED650S-90, ED700, ED700-90, ED900, ED900-90, EDI5, K80F, K80G, LO122, LO60, LO61, LO78, M60, NK43, NK48, NK52, NK60, NKD43, NKD48, NKD52, NKD60, T3-80, T4-80, T5-80, T6-80, UNI43R, UNI43RD, UNI48R, UNI48RD, UNI53R, UNI53RD		

			
1			
GEV No.	510876	Ref. No.	33530 H200412
description	flat gasket rubber ED ø 45mm ID ø 33mm thickness 3mm Qty 1 pcs		
For models:	C81, C81E, C81EBT, C90, C90DE, C90DE2, C90E, C90E2, C90EBT, C90EBT2, C98, CA120, CA55, CA90, CAP10, CAP10BT, CAP10DE, CAP12, CAP12DE, CAP12EBT, CAP7, CAP7E, ED550, ED600-95, ED650E, ED650S, ED700-90, EDI13, EDI13-2, EDI13ALTA, EDI13ALTA-2, EDI13ALTABT, EDI13BT, EDI4, EDI5, EDI6, EDI6-2, EDI6BT, EDI8, EDI8-2, EDI8BT, EDT100, EDT140, EDT170, EDT200, EDT230, EDT85, HD130BT, HD40ALTABT, HD40BT...(Other models you can see in the webshop)		

			
1			
GEV No.	511196	Ref. No.	200919
description	flat gasket rubber ED ø 59mm ID ø 48mm thickness 2mm Qty 1 pcs		
For models:	60EBT, C68EBT, C6EBT, C81EBT, C90EBT2, CAP10BT, CAP12EBT, DP50EBT, EDI13ALTABT, EDI13BT, EDI4, EDI6BT, EDI8BT, HD130BT, HD40ALTABT, HD40BT, HD60BT, HD80BT, ST48EBT, ST60EBT		

			
1			
GEV No.	512217	Ref. No.	25259
description	flat gasket rubber ED ø 61mm ID ø 47.5mm thickness 3mm Qty 1 pcs equiv. no. 25259 suitable for HOONVED		
For models:	CM43, CM48, CM52, CM60, CMD43, CMD48, CMD52, CMD60, E36, E40, E43, E50, NK43, NK48, NK52, NK60, NKD43, NKD48, NKD52, NKD60, UNI43R, UNI43RD, UNI48R, UNI48RD, UNI53R, UNI53RD		

			
1			
GEV No.	512140	Ref. No.	31423
description	flat gasket rubber ED ø 65mm ID ø 51mm thickness 3mm Qty 1 pcs		
For models:	60BT, 60BT-3, APS60, C35, C43, C43ALTA, C43D, C48, C48D, C48DDL, C48DL, C53, C53D, C6, C60, C60D, C6D, CDN3, CDN4, CM48, CM52, CMD43, CMD52, CR43, CR43D, CR48, CR48D, DP35, DP35D, DP40, DP40D, DP45, DP45D, DP50, DP50D, DP50D-115V, FW50, GS-X1011, GS-X1011-WEH, GS-X1021, GS-X1021-WEH, RSP50, RSP50A, SD5BT, SP35, SP35ALTA, SP35D, SP40, SP40D, SP40DDL...(Other models you can see in the webshop)		

			
1			
GEV No.	512350	Ref. No.	25260
description	flat gasket rubber ED ø 65mm ID ø 51mm thickness 3mm Qty 1 pcs equiv. no. 25260 suitable for HOONVED		
For models:	BPS43, C3, C4, C53, C60, CM43, CM48, CM52, CM60, CMD43, CMD48, CMD52, CMD60, E36, E40, E43, E50, ED630-90, M60, NK43, NK48, NK52, NK60, NKD43, NKD48, NKD52, NKD60, T3-80, T4-80, T5-80, T6-80, TS43, TS48		

Зип, Общепит

plastic gaskets

vsezip.ru

17(812)987-08-81



1

GEV No.	516254	Ref. No.	33529 H200410
description	flat gasket rubber ED ø 66mm ID ø 46mm thickness 2mm Qty 1 pcs		
For models:	60BT-3, C81, C81E, C90, C90DE, C90E, C90EBT, C98, CA120, CA55, CA90, CAP7, CAP7E, ED550, ED600-95, ED650E, ED650S, ED700-90, EDI13, EDI13-2, EDI13ALTA, EDI13ALTA-2, EDI13ALTABT, EDI13BT, EDI5, EDI6, EDI6-2, EDI6BT, EDI8, EDI8-2, EDI8BT, EDT100, EDT140, EDT170, EDT200, EDT230, EDT85, LO134, LO134-2, LO134ALTA, LO134ALTA-2, LO50, LO50E, LO60, LO61, LO62, LO67, LO67-2, LO78, LO83...(Other models you can see in the webshop)		



1

GEV No.	510875	Ref. No.	26289
description	flat gasket rubber ED ø 68mm ID ø 48mm thickness 2mm Qty 1 pcs		
For models:	ED600-95, ED630-90, ED650E, ED650E-90, ED650S, ED650S-90, ED700, ED700-90, ED900, ED900-90, EDI5, K80F, K80G, LO122, LO60, LO61, LO78		



1

GEV No.	510832	Ref. No.	H200906
description	flat gasket rubber ED ø 92mm ID ø 66mm thickness 2mm Qty 1 pcs equiv. no. 200906/33456		
For models:	C81, C90, C90EBT, C98, CA120, CA55, CA90, CAP7, CAP7E, ED550, ED650E, ED650S, EDI13-2, EDI13ALTA-2, EDI6-2, EDI6BT, EDI8-2, EDT100, EDT140, EDT170, EDT200, EDT230, EDT85, LO134-2, LO134ALTA-2, LO50, LO62, LO67-2, LO83-2, RCA1100, RCA1200, RCA1200i, RLO50, SMW15, SO55, SO55E, SP81, TR100, TR140, TR170, TR200, TR230, TR90, TR-E100, TR-E150, TR-E170, TR-E200, TR-E230, TR-E90, US-X501		



1

GEV No.	510883	Ref. No.	25265
description	gasket rubber ED ø 86mm ID ø 66mm thickness 2mm for salt tank Qty 1 pcs		
For models:	C43D, C48D, C48D-2, C48DDL, C48E, C53D, C53DE, C60D, C60DE, C68DE, C68E, C6D, C6DE, C90DE2, CDN3, CDN4, CMD43, CMD48, CMD52, CR43D, CR48D, DP35D, DP35D-2, DP40D, DP40D-2, DP40D-rib2, DP45D, DP50D, DP50D-115V, GS-X1011, GS-X1011-2, GS-X1011-WEH, GS-X1011-WEH-2, GS-X1021, GS-X1021-2, GS-X1021-2rib, GS-X1021-WEH, GS-X1021-WEH-2, GS-X1021-WEH-2rib, NKD43, NKD48, NKD52, RSP40A, RSP50A, SP35D, SP40D, SP40D-2, SP40DDL, SP40E, SP45D...(Other models you can see in the webshop)		

1

GEV No.	510450	Ref. No.	34192
description	gasket plastic ED ø 14mm ID ø 8mm thickness 3mm Qty 1 pcs		
For models:	AP53E, AP60E, C53DE, C53E, C60DE, C60E, C68DE, C68E, C6DE, C6E, C81EBT, C90EBT2, C98, DP45DE, DP45E, DP50DE, DP50E, EDI13, EDI13-2, EDI13ALTA, EDI13ALTA-2, EDI4, EDI6, EDI6-2, EDI8, EDI8-2, HD40ALTABT, HD40BT, HD60BT, HD80BT, LO134, LO134-2, LO134ALTA, LO134ALTA-2, LO56, LO62, LO67, LO67-2, LO83, LO83-2, RLO200, RLO300, RLO400, SP45DE, SP45E, SP50DE, SP50E, SP50E-400V3-50Hz-MARINE, SP50E-440V3-60Hz-MARINE, SP5DE...(Other models you can see in the webshop)		



1

GEV No.	511146	Ref. No.	H200495
description	gasket plastic ED ø 43mm ID ø 36mm Qty 1 pcs		

foam rubber gaskets



1

GEV No.	505307	Ref. No.	00991 35996
description	foam rubber gasket W 15mm thickness 5mm suitable for HOONVED with layer		
For models:	C98, ED600-95, ED700-90, ED900-90, EDI13, EDI13-2, EDI13ALTA, EDI13ALTA-2, EDI5, EDI6, EDI6-2, EDI8, EDI8-2, LO122, LO134, LO134-2, LO134ALTA, LO134ALTA-2, LO60, LO61, LO62, LO67, LO67-2, LO78, LO83, LO83-2, RLO200, RLO300, RLO400		



1

GEV No.	505303	Ref. No.	200957 H200957
description	foam rubber gasket W 28mm thickness 2.7mm self-adhesive Qty 640mm punched		
For models:	CAP10, CAP10BT, CAP10DE, CAP12, CAP12DE, CAP12EBT, CAP7E, SO100, SO100-400V3-50Hz-MARINE, SO100-440V3-60Hz-MARINE, SO120		



Зип Общежит
Special gaskets

vsezip.ru

+7(812)987-08-814



1

GEV No.	505309	Ref. No.	33409
description	foam rubber gasket W 29mm thickness 3mm self-adhesive Qty 600mm suitable for HOONVED punched		
For models:	CA120, CA55, CA90, CAP7, CAP7E, ED550, ED650E, ED650S, RCA1100, RCA1200, RCA1200i, SO55, SO55-400V3-50Hz-MARINE, SO55-440V3-60Hz-MARINE, SO55E		



1

GEV No.	510881	Ref. No.	H200433
description	foam rubber gasket W 6mm thickness 2.5mm self-adhesive Qty 1m		
For models:	C35E, C43DE, C43E, C46DE, C46E, C98, EDI13-2, EDI13ALTA-2, EDI13ALTABT, EDI13BT, EDI4, EDI6-2, EDI6BT, EDI8-2, EDI8BT, LO134-2, LO134ALTA-2, LO56, LO62, LO67-2, LO83-2, SP35DE, SP35E, SP40DE, SP40E, SPB35E, TR170, TR-E170		



1

GEV No.	510880	Ref. No.	33408
description	foam rubber gasket W 8mm thickness 4mm self-adhesive Qty supplied by meter		
For models:	60BT, 60BT-3, 60EBT, C35, C43-2, C48-2, C48D-2, C48E, C53DE, C53E, C6, C60DE, C60E, C68DE, C68E, C68EBT, C6D, C6DE, C6E, C6EBT, C81, C81E, C81EBT, CA120, CA55, CA90, CAP7, CAP7E, DP35, DP35-2, DP35D, DP35D-2, DP40, DP40-2, DP40D, DP40D-2, DP40D-rib2, DP40-rib2, DP45, DP45D, DP50, DP50D, DP50D-115V, ED550, ED650E, ED650S, EDI13-2, EDI13ALTA-2, EDI13ALTABT, EDI13BT...(Other models you can see in the webshop)		

shaft gaskets

v-rings



1

GEV No.	511631	Ref. No.	H200480
description	gasket ID ø 13.5mm ED ø 26mm H 10mm		
For models:	EDT100, EDT140, EDT170, EDT200, EDT230, EDT85, TR100, TR140, TR170, TR200, TR230, TR90, TR-E100, TR-E150, TR-E170, TR-E200, TR-E230		

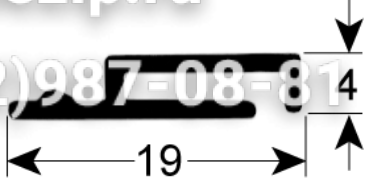

1

GEV No.	511311	Ref. No.	H200923
description	door seal L 1000mm dishwasher suitable for COMENDA equiv. no. 200923		
For models:	EDI13-2, EDI13ALTA-2, EDI6-2, EDI8-2, LO134-2, LO134ALTA-2, LO67-2, LO83-2		

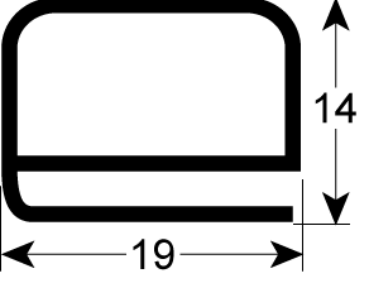

1

GEV No.	511990	Ref. No.	36926
description	door seal L 590mm		
For models:	60EBT, C53DE, C53E, C60DE, C60E, C68DE, C68E, C68EBT, C6DE, C6E, SP45DE, SP45E, SP50DE, SP50E, SP50E-400V3-50Hz-MARINE, SP50E-440V3-60Hz-MARINE, SP5DE, SP5E, SP68DE, SP68E		

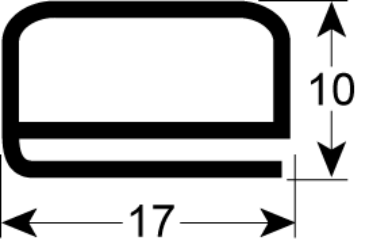

1

GEV No.	511989	Ref. No.	36883
description	door seal Qty supplied by meter		
For models:	EDI13-2, EDI13ALTA-2, EDI13ALTABT, EDI13BT, EDI4, EDI6-2, EDI6BT, EDI8-2, EDI8BT, HD130BT, HD40ALTABT, HD40BT, HD60BT, HD80BT, LO134-2, LO134ALTA-2, LO56, LO67-2, LO83-2		



1

GEV No.	510881	Ref. No.	H200433
description	foam rubber gasket W 6mm thickness 2.5mm self-adhesive Qty 1m		
For models:	C35E, C43DE, C43E, C46DE, C46E, C98, EDI13-2, EDI13ALTA-2, EDI13ALTABT, EDI13BT, EDI4, EDI6-2, EDI6BT, EDI8-2, EDI8BT, LO134-2, LO134ALTA-2, LO56, LO62, LO67-2, LO83-2, SP35DE, SP35E, SP40DE, SP40E, SPB35E, TR170, TR-E170		

Зип-Общепит

the most gaskets

vsezip.ru

+7(812)987-08-81



1

GEV No.	510880	Ref. No.	33408
description	foam rubber gasket W 8mm thickness 4mm self-adhesive Qty supplied by meter		
For models:	60BT, 60BT-3, 60EBT, C35, C43-2, C48-2, C48D-2, C48E, C53DE, C53E, C6, C60DE, C60E, C68DE, C68E, C68EBT, C6D, C6DE, C6E, C6EBT, C81, C81E, C81EBT, CA120, CA55, CA90, CAP7, CAP7E, DP35, DP35-2, DP35D, DP35D-2, DP40, DP40-2, DP40D, DP40D-2, DP40D-rib2, DP40-rib2, DP45, DP45D, DP50, DP50D, DP50D-115V, ED550, ED650E, ED650S, EDI13-2, EDI13ALTA-2, EDI13ALTABT, EDI13BT...(Other models you can see in the webshop)		



1

GEV No.	501353	Ref. No.	200491 H200491
description	gasket for thermostat hole ø 6.6mm L 98mm W 68mm thickness 2mm		
For models:	AC101, AC151, AC181, AC201, AC241, AC91, EDT100, EDT140, EDT170, EDT200, EDT230, EDT85, TR100, TR140, TR170, TR200, TR230, TR90, TR-E100, TR-E150, TR-E170, TR-E200, TR-E230, TR-E90		

miscellaneous



1

GEV No.	512039	Ref. No.	26515
description	gasket for boiler		
For models:	CM43, CM48, CM52, CM60, CMD43, CMD48, CMD52, CMD60, E40, E43, E50, ED700-90, ED900-90, K80F, K80G, LO122, LO78, NK43, NK48, NK52, NK60, NKD43, NKD48, NKD52, NKD60, T3-80, T4-80, T5-80, T6-80, UNI43R, UNI43RD, UNI48R, UNI48RD, UNI53R, UNI53RD		



1

GEV No.	512154	Ref. No.	H200494
description	gasket for thermostat ID ø 20mm equiv. no. 200494/H200494 hole distance 41mm suitable for COMENDA, HOONVED		
For models:	60BT, 60BT-3, APS43, APS48, APS48B, APS53, APS60, APSE43, APSE48, APSE53, APSE60, C35, C35E, C43, C43-2, C43ALTA, C43D, C43DE, C43E, C46DE, C46E, C48, C48-2, C48D, C48D-2, C48DDL, C48DL, C48E, C53, C53D, C6, C60, C60D, C6D, CDN3, CDN4, CR43, CR43D, CR48, CR48D, DP35, DP35-2, DP35D, DP35D-2, DP40, DP40-2, DP40D, DP40D-2, DP40D-rib2, DP40-rib2...(Other models you can see in the webshop)		



1

GEV No.	505314	Ref. No.	31063
description	gasket for wash arm thickness 1mm L 74.5mm W 42mm		
For models:	ED600-95, ED700-90, ED900-90, EDI5, LO122, LO60, LO61, LO78		



transmission technology and ball bearings

chains

roller chains 08B-1 single



1

GEV No.	697897	Ref. No.	H410801
description	roller chain DIN/ISO 08 B-1 splitting 1/2" / 12.7mm links 39 internal width 7.75mm rollerø 8.51mm single		
For models:	EDT100, EDT140, EDT170, EDT200, EDT230, EDT85, TR100, TR140, TR170, TR200, TR230, TR90, TR-E100, TR-E150, TR-E170, TR-E200, TR-E230		
accessories for	697897		
	GEV No.	693276	Ref. No. H410903
	connector single DIN/ISO 08 B-1 splitting 1/2" links 1 L 23mm internal width 11.8mm rollerø 4.3mm metal		
	GEV No.	697841	Ref. No. H410902
	half link single DIN/ISO 08 B-1 splitting 1/2"		



1

GEV No.	511370	Ref. No.	160837 H160837
description	gasket L 34mm W 14mm for door guides ID ø 7mm thickness 3mm		
For models:	APS43, APS48, APS48B, APS53, APS60, C81, C90, DP35, DP35-2, DP35D, DP35D-2, DP40, DP40-2, DP40D, DP40D-2, DP40D-rib2, DP40-rib2, DP45, DP45D, DP50, DP50D, FW35, FW40, FW40B, FW45, FW50, LO50, RLO50, SP81, STS43, STS43-2, STS43D, STS43D-2, STS48, STS48-2, STS48D, STS48D-2, STS48D-rib2, STS48-rib2, STS53, STS53D, STS60, STS60D, US-X501		



1

GEV No.	510885	Ref. No.	33784
description	gasket suitable for COMENDA equiv. no. 200464 L 60mm W 30mm		
For models:	CDN3, CDN4, CR43, CR43D, CR48, CR48D, SPR36, SPR36D, SPR41, SPR41D		



connectors



GEV No.	693276	Ref. No.	H410903
description	connector single DIN/ISO 08 B-1 splitting 1/2" links 1 L 23mm internal width 11.8mm rollerø 4.3mm metal		
For models:	EDT100, EDT140, EDT170, EDT200, EDT230, EDT85, TR100, TR140, TR170, TR200, TR230, TR90, TR-E100, TR-E150, TR-E170, TR-E200, TR-E230		

half links



GEV No.	697841	Ref. No.	H410902
description	half link single DIN/ISO 08 B-1 splitting 1/2"		
For models:	EDT100, EDT140, EDT170, EDT200, EDT230, EDT85, TR100, TR140, TR170, TR200, TR230, TR90, TR-E100, TR-E150, TR-E170, TR-E200, TR-E230		

springs

torsion springs



GEV No.	512017	Ref. No.	35870
description	spring ø 11mm wire gauge ø 2mm for filter		

compression springs



GEV No.	512102	Ref. No.	30438
description	compression spring		
For models:	60BT, 60BT-3, 60EBT, APS43, APS48, APS48B, APS53, APS60, APSE43, APSE48, APSE53, APSE60, BPN48, BPS43, BPS52, C3, C35, C4, C43, C43-2, C43ALTA, C43D, C43DE, C43E, C46DE, C46E, C48, C48-2, C48D, C48D-2, C48DDL, C48DL, C48E, C53, C53D, C53DE, C53E, C6, C60, C60D, C60DE, C60E, C68DE, C68E, C6D, C6DE, C6E, C81, C81E, C81EBT...(Other models you can see in the webshop)		

Зип Общепит

vsezip.ru

+7(812)987-08-81

GEV No.	512108	Ref. No.	30426
description	compression spring ø 4mm L 60mm wire gauge ø 2mm		
For models:	60EBT, AP53E, AP60E, BPS43, C3, C35E, C4, C43-2, C43ALTA, C43DE, C43E, C46DE, C46E, C48-2, C48D-2, C48DDL, C48DL, C48E, C53, C53D, C53DE, C53E, C60DE, C60E, C68DE, C68E, C68EBT, C6DE, C6E, C6EBT, DP35, DP35-2, DP35D, DP35D-2, DP40, DP40-2, DP40D, DP40D-2, DP40D-rib2, DP40-rib2, DP45, DP45D, DP45DE, DP45E, DP50DE, DP50E, DP50EBT, E40-2F, GS-X1011, GS-X1011-2...(Other models you can see in the webshop)		



GEV No.	511376	Ref. No.	450234
description	compression spring ø 6mm L 25mm wire gauge ø 0.65mm		
For models:	C35E, C68DE, C68E, C68EBT, C90DE2, C90E2, C90EBT2		

roller springs

roller springs



GEV No.	511663	Ref. No.	391318 H391318
description	roller spring 4.5kg complete incl. holder L 125mm W 40mm lug length 125mm		



GEV No.	511922	Ref. No.	H391309
description	roller spring 4kg complete incl. holder L 125mm W 40mm ID ømm lug length 125mm		
For models:	EDT100, EDT140, EDT170, EDT200, EDT230, EDT85, TR200, TR-E200, TR-E230		



GEV No.	511578	Ref. No.	391332 H391332
description	roller spring 5.5kg complete incl. holder W 40mm		
For models:	C98, EDT100, EDT140, EDT170, EDT200, EDT230, EDT85, HG2LR, HGLR, LO62		

Зип Общепит

GEV No.	512033	Ref. No.	34927
description	tension spring ø 21.6mm total length 190mm wire gauge ø 3mm L1 121.5mm		
For models:	EDI13, EDI13-2, EDI13ALTA, EDI13ALTA-2, EDI13ALTABT, EDI13BT, EDI4, EDI5, EDI6-2, EDI6BT, EDI8, EDI8-2, EDI8BT, HD130BT, LO134, LO134-2, LO134ALTA, LO134ALTA-2, LO56, LO67, LO67-2, LO83, LO83-2, RLO200, RLO300, RLO400		



GEV No.	511552	Ref. No.	391351 H391331
description	roller spring complete incl. holder W 40mm ID ømm lug length 70mm		
For models:	AC101, AC151, AC181, AC201, AC241, AC91, EDT100, EDT140, EDT170, EDT200, EDT230, EDT85, HG2LR, HGLR, TR100, TR140, TR170, TR200, TR230, TR90, TR-E100, TR-E150		

tension springs



GEV No.	512373	Ref. No.	25826
description	tension spring		
For models:	ED650E, ED650E-90, ED650S, ED650S-90		



GEV No.	512031	Ref. No.	36625
description	tension spring ø 13.5mm total length 67mm wire gauge ø 1.5mm		
For models:	60EBT, C53DE, C53E, C60DE, C60E, C6DE, C6E, SP50DE, SP50E, SP50E-400V3-50Hz-MARINE, SP50E-440V3-60Hz-MARINE, SP5DE, SP5E		



GEV No.	701045	Ref. No.	450222 H450222
description	tension spring ø 13mm total length 195mm wire gauge ø 1.2mm		



GEV No.	510064	Ref. No.	36860 450298
description	tension spring ø 13mm total length 78mm wire gauge ø 2.5mm L1 14mm L2 50mm L3 14mm		
For models:	60EBT, C60DE, C60E, C68DE, C68E, C68EBT, C6DE, C6E, C6EBT, SP50DE, SP50E, SP68DE, SP68E		



GEV No.	511580	Ref. No.	34773
description	tension spring ø 16.5mm total length 98mm wire gauge ø 2.5mm for dishwasher		
For models:	C81, C81E, C81EBT, C90, C90DE, C90E, C90EBT, LO50, LO50E, RLO50, SMW15, SMW15E, SP81, SP81E, US-X501		



GEV No.	510928	Ref. No.	33522 391316
description	tension spring ø 37mm total length 910mm wire gauge ø 5.3mm for hood C85/140-G75		
For models:	CA120, CA55, CA90, CAP10, CAP10BT, CAP10DE, CAP12, CAP12DE, CAP12EBT, CAP15EBT, CAP7, CAP7E, ED550, ED650E, ED650S, RCA1100, RCA1200, RCA1200i, SO100, SO100-400V3-50Hz-MARINE, SO100-440V3-60Hz-MARINE, SO120, SO55, SO55-400V3-50Hz-MARINE, SO55-440V3-60Hz-MARINE, SO55E		

dosing pumps



peristaltic dosing pumps

SEKO

wall-mounted version

with speed control



GEV No.	361907 ¹	Ref. No.	32570 38127
description	dosing pump SEKO speed control 1-7l/h 230VAC detergent hose ø 4x6mm hose type K hose Santoprene suction level 1.5m type PR with inlet and conveyor hose 6W cable length 2700mm set CODE PPR0007A1000_A		
For models:	C81E, C81EBT, C90DE2, C90E2, C90EBT, C90EBT2, C98, CAP10, CAP10BT, CAP10DE, CAP12, CAP12DE, CAP12EBT, CAP7E, ED600-95, ED700-90, ED900-90, EDI13, EDI13-2, EDI13ALTA, EDI13ALTA-2, EDI13ALTABT, EDI13BT, EDI4, EDI5, EDI6, EDI6-2, EDI6BT, EDI8, EDI8-2, EDI8BT, HD130BT, HD40ALTABT, HD40BT, HD60BT, HD80BT, LO122, LO134, LO134-2, LO134ALTA, LO134ALTA-2, LO56, LO60, LO61, LO62, LO67, LO67-2, LO78, LO83, LO83-2...(Other models you can see in the webshop)		
spare parts for	361907		
	GEV No.	361815	Ref. No. 35137
	pump hose detergent hose ø 6x10mm hose ø 4x6mm hose type K hose Santoprene type SEKO		
	GEV No.	361909	Ref. No. 34024
	hose connector for dosing pump connection 6x4 grommet ø 7mm grommet length 19mm total length 35mm plastic		

¹with accessories



3ип Общежит
membrane dosing pumps

self-priming
various

+7(812)987-08-81

built-in version

with frequency control



GEV No.	361906 ¹	Ref. No.	34358
description	dosing pump SEKO frequency control 2.8l/h 230VAC detergent hose ø 4x6mm hose Santoprene type NBR 3 8W CODE NBR0003A1004		
For models:	60BT, 60BT-3, 60EBT, AP43E, AP48E, AP53E, AP60E, C35E, C43DE, C43E, C46DE, C46E, C53DE, C53E, C60DE, C60E, C68DE, C68E, C68EBT, C6DE, C6E, C6EBT, CAP7E, DP45DE, DP45E, DP50DE, DP50E, FW35E, FW40E, GS-X1021, GS-X1021-2, GS-X1021-2rib, GS-X1021-WEH, GS-X1021-WEH-2, GS-X1021-WEH-2rib, SD5BT, SP35DE, SP35E, SP40DE, SP40E, SP45DE, SP45E, SP50DE, SP50E, SP50E-400V3-50Hz-MARINE, SP50E-440V3-60Hz-MARINE, SPB35E, ST43DE, ST43E, ST48DE...(Other models you can see in the webshop)		

¹with accessories

spare parts



GEV No.	361815	Ref. No.	35137
description	pump hose detergent hose ø 6x10mm hose ø 4x6mm hose type K hose Santoprene type SEKO		
For models:	60BT, 60BT-3, 60EBT, AP43E, AP48E, AP53E, AP60E, C35E, C43DE, C43E, C46DE, C46E, C53DE, C53E, C60DE, C60E, C68DE, C68E, C68EBT, C6DE, C6E, C81E, C81EBT, C90DE2, C90E2, C90EBT, C90EBT2, C98, CAP10, CAP10BT, CAP10DE, CAP12, CAP12DE, CAP12EBT, CAP7E, DP45DE, DP45E, DP50DE, DP50E, EDI13, EDI13-2, EDI13ALTA, EDI13ALTA-2, EDI13ALTABT, EDI13BT, EDI4, EDI5, EDI6, EDI6-2, EDI6BT...(Other models you can see in the webshop)		

miscellaneous



GEV No.	361909	Ref. No.	34024
description	hose connector for dosing pump connection 6x4 grommet ø 7mm grommet length 19mm total length 35mm plastic		
For models:	EDI13, EDI13-2, EDI13ALTA, EDI13ALTA-2, EDI4, EDI6, EDI6-2, EDI8, EDI8-2, HD130BT, HD40ALTABT, HD40BT, HD60BT, HD80BT, LO134, LO134-2, LO134ALTA, LO134ALTA-2, LO56, LO67, LO67-2, LO83, LO83-2		



GEV No.	361002	Ref. No.	620120 H620120
description	dosing pump rinse aid inlet 6x8mm outlet 4x6mm pressure connection ø 4x6mm suction connection ø 6x8mm		
spare parts for	361002		
GEV No.	510297	Ref. No.	H630614
description	membrane for dosing pump ED ø 83mm thickness 1mm dosing pump equiv. no. 630614 suitable for COMENDA		
GEV No.	510298	Ref. No.	—
description	lip valve dosing pump suitable for DB2/DS5		
GEV No.	510299	Ref. No.	—
description	hose connector for dosing pump		
GEV No.	510338	Ref. No.	—
description	union nut dosing pump thread 1/2" ø 32mm H 15mm for dosing pump		
GEV No.	510847	Ref. No.	—
description	gasket polishing agent dosing ID ø 22mm ED ø 32mm external height 5mm		
GEV No.	510870	Ref. No.	H191018
description	filter support for dosing pump		
GEV No.	510916	Ref. No.	—
description	filter for dosing pump		

spare parts



GEV No.	510870	Ref. No.	H191018
description	filter support for dosing pump		







GEV No.	510297	Ref. No.	H630614
description	membrane for dosing pump ED ø 83mm thickness 1mm dosing pump equiv. no. 630614 suitable for COMENDA		



self-priming with supporting pressure

HOONVED



GEV No.	361010	Ref. No.	20007 20008 21428 21560 21729 21951 22060
description	dosing pump rinse aid pressure connection ø 4x6mm suction connection ø 4mm auxiliary pressure connection 10mm HOONVED		
For models:	60BT, 60BT-3, 60EBT, APS43, APS48, APS48B, APS53, APS50, APSE43, APSE48, APSE60, C3, C35, C4, C43, C43ALTA, C43D, C48, C48D, C48DDL, C48DL, C53, C53D, C60, C60D, C68EBT, C6EBT, C81, C81EBT, C90, C90DE2, C90EBT, C90EBT2, CA120, CA55, CA90, CAP10BT, CAP12EBT, CDN3, CDN4, CM43, CM48, CM52, CM60, CMD43, CMD48, CMD52, CMD60, CR43, CR43D...(Other models you can see in the webshop)		
spare parts for	361010		
	GEV No.	Ref. No.	25211
	lip valve rinse aid pressure connection ømm suction connection ømm auxiliary pressure connectionmm		
	GEV No.	Ref. No.	31596 630632
	membrane rinse aid pressure connection ømm suction connection ømm auxiliary pressure connectionmm		
accessories for	361010		
	GEV No.	Ref. No.	—
	PVC hose ID ø 4mm ED ø 6mm L 2m thickness 1mm t.max. 60°C transparent		
	GEV No.	Ref. No.	—
	nylon hose ID ø 4mm ED ø 6mm L 2m thickness 1mm operating p. 10bar burst p. 50bar t.max. 100°C transparent		



GEV No.	361908	Ref. No.	35991 620736V01
description	dosing pump rinse aid pressure connection ø 7mm suction connection ø 5mm auxiliary pressure connection 10mm		
For models:	AP43E, AP48E, C35E, C43DE, C43E, C46DE, C46E, C90E2, FW35E, FW40E, SP35DE, SP35E, SP40DE, SP40E		

Зип Общепит

vsezip.ru

+7(812)987-08-81



GEV No.	361387	Ref. No.	35388
description	dosing pump rinse aid pressure connection ø 8mm suction connection ø 4mm auxiliary pressure connection 10mm		
For models:	60BT, AP53E, AP60E, C35, C43-2, C48-2, C48D-2, C48E, C53DE, C53E, C6, C60DE, C60E, C68DE, C68E, C6D, C6DE, C6E, C81E, C90, C90DE, C90DE2, C90E, C98, CAP10, CAP10DE, CAP12, CAP12DE, CAP7, CAP7E, CDN3, CDN4, DP35-2, DP35D-2, DP40-2, DP40D-2, DP40D-rib2, DP40-rib2, DP45DE, DP45E, DP50DE, DP50E, EDI13, EDI13-2, EDI13ALTA, EDI13ALTA-2, EDI5, EDI6, EDI6-2, EDI8...(Other models you can see in the webshop)		
spare parts for	361387		
	GEV No.	Ref. No.	25211
	lip valve rinse aid pressure connection ømm suction connection ømm auxiliary pressure connectionmm		
	GEV No.	Ref. No.	31596 630632
	membrane rinse aid pressure connection ømm suction connection ømm auxiliary pressure connectionmm		
	GEV No.	Ref. No.	—
	O-ring EPDM thickness 2.62mm ID ø 15.88mm Qty 1 pcs		
accessories for	361387		
	GEV No.	Ref. No.	—
	PVC hose ID ø 8mm ED ø 12mm L 10m thickness 2mm t.max. 60°C transparent		
	GEV No.	Ref. No.	—
	PVC hose ID ø 4mm ED ø 6mm L 2m thickness 1mm t.max. 60°C transparent		



GEV No.	361383	Ref. No.	25211
description	lip valve rinse aid pressure connection ømm suction connection ømm auxiliary pressure connectionmm		
For models:	60BT, 60BT-3, 60EBT, AP43E, AP48E, AP53E, AP60E, APS43, APS48, APS48B, APS53, APS60, APSE43, APSE48, APSE53, APSE60, BPN48, BPS43, BPS52, C3, C35, C35E, C4, C43, C43-2, C43ALTA, C43D, C43DE, C43E, C46DE, C46E, C48, C48-2, C48D, C48D-2, C48DDL, C48DL, C48E, C53, C53D, C53DE, C53E, C6, C60, C60D, C60DE, C60E, C68DE, C68E, C68EBT...(Other models you can see in the webshop)		

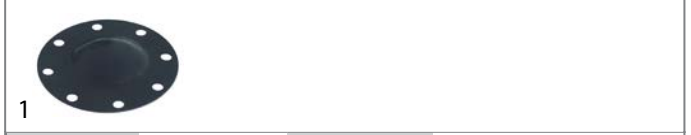

GEV No.	361384	Ref. No.	31596 630632
description	membrane rinse aid pressure connection ømm suction connection ømm auxiliary pressure connectionmm		
For models:	60BT, 60BT-3, 60EBT, AP43E, AP48E, AP53E, AP60E, APS43, APS48, APS48B, APS53, APS60, APSE43, APSE48, APSE53, APSE60, C3, C35, C35E, C4, C43, C43-2, C43ALTA, C43D, C43DE, C43E, C46DE, C46E, C48, C48-2, C48D, C48D-2, C48DDL, C48DL, C48E, C53, C53D, C53DE, C53E, C6, C60, C60D, C60DE, C60E, C68DE, C68E, C68EBT, C6D, C6DE, C6E...(Other models you can see in the webshop)		



electronic controllers



1

GEV No.	361831	Ref. No.	31822
description	conductivity meter GICAR type 8.5.01.56		
For models:	ED600-95, ED700-90, ED900-90, LO122, LO60, LO78		

accessories

T-pieces

without non-return valve



1

GEV No.	512093	Ref. No.	33817
description	T-piece connection 1: 12mm connection 2: 4mm		
For models:	C35, C43, C43ALTA, C43D, C48, C48D, C48DDL, C48DL, C53, C53D, C60, C60D, C81, C90, CA120, CA55, CA90, CR43, CR43D, CR48, CR48D, DP35, DP35D, DP40, DP40D, DP45, DP45D, DP50, DP50D, DP50D-115V, ED550, ED650E, ED650S, GS-X1011, GS-X1011-WEH, GS-X1021, GS-X1021-WEH, LO50, RCA1100, RCA1200, RCA1200i, RLO50, SP35, SP35ALTA, SP35D, SP40, SP40D, SP40DDL, SP40DL, SP45...(Other models you can see in the webshop)		
accessories for	512093		
	GEV No.	361083	Ref. No.
			—
	union nut T1: M10x1 for hose 6mm		

tank inlets



1

GEV No.	361270	Ref. No.	H251213
description	tank inlet SS M12 hose ø 4mm		
For models:	60EBT, AP43E, AP48E, C43DE, C43E, C46DE, C46E, C53DE, C53E, C60DE, C60E, C68DE, C68E, C68EBT, C6DE, C6E, C81E, C90DE2, C90E2, C90EBT, C90EBT2, C98, CAP10, CAP10BT, CAP12, CAP7E, EDI13, EDI13-2, EDI13ALTA, EDI13ALTA-2, EDI4, EDI6, EDI6-2, EDI8, EDI8-2, FW35E, FW40E, LO134-2, LO134ALTA-2, LO62, LO67-2, LO83-2, SMW15E, SO100, SO100-400V3-50Hz-MARINE, SO100-440V3-60Hz-MARINE, SO120, SO55E, SP35DE, SP35E...(Other models you can see in the webshop)		

Зип-Общепит hoses

supply hoses

PVC supply hoses



1

GEV No.	520631	Ref. No.	25235
description	supply hose PVC straight-straight DN13 connections 3/4" L 1500mm operating p. 10bar burst p. 32bar t.max. 90°C approval VDE flat seal		
For models:	APS43, APS48, APS48B, APS53, APS60, APSE43, APSE48, APSE53, APSE60, BPN48, BPS43, BPS52, C3, C35, C4, C43, C43-2, C43ALTA, C43D, C43DE, C43E, C46DE, C46E, C48, C48-2, C48D, C48D-2, C48DDL, C48DL, C48E, C53, C53D, C53DE, C53E, C6, C60, C60D, C60DE, C60E, C68DE, C68E, C6D, C6DE, C6E, C81, C81E, C90, C90E, CA55, CAP7...(Other models you can see in the webshop)		

drain hoses



1

GEV No.	530587	Ref. No.	24044 27110
description	drain hose DN28 L 2000mm straight ø inside 32mm straight ext. ø 40mm outer hose ø 35mm		
For models:	C81, C81E, C81EBT, C90, C90DE, C90DE2, C90E, C90E2, C90EBT, C90EBT2, C98, CA120, CA55, CA90, CAP10, CAP10BT, CAP10DE, CAP12, CAP12DE, CAP12EBT, CAP7, CAP7E, ED550, ED600-95, ED630-90, ED650E, ED650E-90, ED650S, ED650S-90, ED700-90, ED900-90, EDI13, EDI13-2, EDI13ALTA, EDI13ALTA-2, EDI13ALTABT, EDI13BT, EDI4, EDI5, EDI6, EDI6-2, EDI6BT, EDI8, EDI8-2, EDI8BT, HD130BT, HD40ALTABT, HD40BT, HD60BT, HD80BT...(Other models you can see in the webshop)		

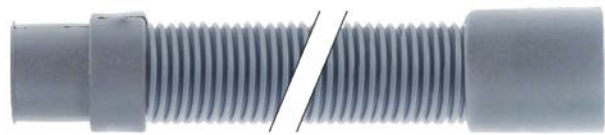

1

GEV No.	530607	Ref. No.	200779 34106
description	drain hose DN24 L 2000mm A int. ø 24mm A ext. ø 28mm B int. ø 28mm B ext. ø 35mm outer hose ø 29mm temp.-resist. 90°C		
For models:	C35E, C43DE, C43E, C46DE, C46E, SP35DE, SP35E, SP40DE, SP40E, SPB35E, ST48EBT		



Зип Общепит
Industrial hoses

Niplaflex hoses
vsezip.ru

+7(812)987-08-81



1

GEV No.	530616	Ref. No.	27078
description	drain hose L 1500mm A int. ø 25mm B int. ø 25mm outer hose ø 32mm		
For models:	60BT, 60BT-3, 60EBT, C3, C4, C53, C53D, C53DE, C53E, C6, C60, C60D, C60DE, C60E, C68DE, C68E, C68EBT, C6D, C6DE, C6E, C6EBT, C98, CM43, CM48, CM52, CM60, CMD43, CMD48, CMD52, CMD60, DP45, DP45D, DP45DE, DP45E, DP50, DP50D, DP50D-115V, DP50DE, DP50E, DP50EBT, E36, E40, E40-2F, E43, E50, INDY43F, INDY48F, LO62, M60, NK43...(Other models you can see in the webshop)		



1

GEV No.	530561	Ref. No.	00182 200122 H200122
description	pressure hose ID ø 10mm ED ø 17mm L 5m thickness 3.5mm operating p. 10bar burst p. 30bar t.max. 110°C		
For models:	60BT, 60BT-3, 60EBT, AP43E, AP48E, AP53E, AP60E, APS43, APS48, APS48B, APS53, APS60, APSE43, APSE48, APSE53, APSE60, BPS43, C3, C35, C35E, C4, C43, C43-2, C43ALTA, C43D, C43DE, C43E, C46DE, C46E, C48, C48-2, C48D, C48D-2, C48DDL, C48DL, C48E, C53, C53D, C53DE, C53E, C6, C60, C60D, C60DE, C60E, C68DE, C68E, C68EBT, C6D, C6DE...(Other models you can see in the webshop)		



1

GEV No.	506207	Ref. No.	27386
description	drain hose DN19 L 1500mm straight ø inside 19mm straight ext. ø 24mm elbow ø inside 21mm elbow ext. ø 27mm outer hose ø 25mm		
For models:	60EBT, AP43E, AP48E, APS43, APS48, APS48B, APS53, APS60, APSE43, APSE48, APSE53, APSE60, BPN48, BPS43, BPS52, C35E, C43DE, C43E, C46DE, C46E, C53DE, C53E, C60DE, C60E, C68DE, C68E, C6DE, C6E, FW35, FW35E, FW40, FW40B, FW40E, FW45, FW50, SP35DE, SP35E, SP40DE, SP40E, SP45DE, SP45E, SP50DE, SP50E, SP50E-400V3-50Hz-MARINE, SP50E-440V3-60Hz-MARINE, SP5DE, SP5E, SP68DE, SP68E, SPB35E...(Other models you can see in the webshop)		

pressure control hoses



1

GEV No.	530560	Ref. No.	00181 H160121
description	pressure control hose ID ø 5mm ED ø 9mm L 5m operating p. 30bar burst p. 90bar temp.-resist. 60°C		
For models:	60BT, 60BT-3, 60EBT, APS43, APS48, APS48B, APS53, APS60, APSE43, APSE48, APSE53, APSE60, BPN48, BPS43, BPS52, C3, C35, C35E, C4, C43, C43-2, C43ALTA, C43D, C43DE, C43E, C46DE, C46E, C48, C48-2, C48D, C48D-2, C48DDL, C48DL, C48E, C53, C53D, C53DE, C53E, C6, C60, C60D, C60DE, C60E, C68DE, C68E, C68EBT, C6D, C6DE, C6E, C90DE...(Other models you can see in the webshop)		



1

GEV No.	530613	Ref. No.	200346 34106
description	drain hose DN19 L 3000mm straight ø inside 21mm straight ext. ø 27mm elbow ø inside 21mm elbow ext. ø 27mm outer hose ø 20mm		
For models:	C35, C35E, C43, C43-2, C43ALTA, C43D, C43DE, C43E, C46DE, C46E, C48, C48-2, C48D, C48D-2, C48DDL, C48DL, C48E, CAP15EBT, CDN3, CDN4, CR43, CR43D, CR48, CR48D, DP35, DP35-2, DP35D, DP35D-2, DP40, DP40-2, DP40D, DP40D-2, DP40D-rib2, DP40-rib2, EDI13, EDI13ALTA, EDI6, EDI8, GS-X1011, GS-X1011-2, GS-X1011-WEH, GS-X1011-WEH-2, GS-X1021, GS-X1021-2, GS-X1021-2rib, GS-X1021-WEH, GS-X1021-WEH-2, GS-X1021-WEH-2rib, LO134, LO134ALTA...(Other models you can see in the webshop)		

formed hoses

straight



1

GEV No.	512133	Ref. No.	33949
description	formed hose D1 ø 43mm D2 ø 37mm L 141mm dishwasher straight		
For models:	C53, C53D, DP45, DP45D, SP45, SP45D, STS53, STS53D, TN-TDN5, TN-TDN6		



Зип Общепит

vsezip.ru

+7(812)987-08-81



1

GEV No.	511362	Ref. No.	33455
description	formed hose dishwasher straight equiv. no. 200758		
For models:	CA120, CA55, CA90, CAP7, CAP7E, ED550, ED650E, ED650S, RCA1100, RCA1200, RCA1200i, SO55, SO55-400V3-50Hz-MARINE, SO55-440V3-60Hz-MARINE, SO55E		



1

GEV No.	506412	Ref. No.	200105 H200105
description	formed hose dishwasher straight hose ext. ø 60mm hose int. ø 50mm		
For models:	AC101, AC181, AC201, AC241, AC91, EDT100, EDT140, EDT170, EDT200, EDT230, EDT85, TR100, TR140, TR170, TR200, TR230, TR90, TR-E100, TR-E150, TR-E170, TR-E200, TR-E230, TR-E90		



1

GEV No.	511366	Ref. No.	200759 H200759
description	formed hose dishwasher straight equiv. no. 200759		
For models:	60BT, C81EBT, C90EBT, CAP10BT, CAP12EBT, CAP15EBT, EDT100, EDT140, EDT170, EDT200, EDT230, EDT85, HD130BT, HD60BT, HD80BT, HTP195, HTP205, HTP220, SD5BT, TR100, TR140, TR170, TR200, TR230, TR90, TR-E100, TR-E150, TR-E170		

GEV No.	506412	Ref. No.	200105 H200105
description	formed hose dishwasher straight hose ext. ø 60mm hose int. ø 50mm		
For models:	AC101, AC181, AC201, AC241, AC91, EDT100, EDT140, EDT170, EDT200, EDT230, EDT85, TR100, TR140, TR170, TR200, TR230, TR90, TR-E100, TR-E150, TR-E170, TR-E200, TR-E230, TR-E90		



1

GEV No.	512359	Ref. No.	32055
description	formed hose dishwasher straight equiv. no. 32055		
For models:	APS43, APS48, APS48B, APS53, APS60, APSE43, APSE48, APSE53, APSE60, FW35, FW40, FW40B, FW45, FW50		

form L



1

GEV No.	530054	Ref. No.	200767 H200767
description	formed hose		



1

GEV No.	512363	Ref. No.	32880
description	formed hose dishwasher straight equiv. no. 32880		
For models:	C3, C4		



1

GEV No.	524821	Ref. No.	36028
description	formed hose end piece A ext. ø 35mm end piece A int. ø 27mm AD2 ø 35mm ø end piece B 27mm L 145mm Qty 1 warewashing L-shape		
For models:	60BT-3, 60EBT, C68EBT, C6EBT, C90EBT, C90EBT2, CAP10BT, CAP12EBT, DP50EBT, EDI4, LOS6, SD5BT, ST48EBT, ST60EBT		



1

GEV No.	512365	Ref. No.	33541
description	formed hose dishwasher straight equiv. no. 35498		
For models:	C43ALTA, C48DDL, C48DL, DP35, DP35D, DP40, DP40D, GS-X1011, GS-X1011-WEH, GS-X1021, GS-X1021-WEH, SP35ALTA, SP40DDL, SP40DL, STS43, STS43D, STS48, STS48D		



1

GEV No.	512358	Ref. No.	30014
description	formed hose end piece A ext. ø 53mm end piece A int. ø 39mm AD2 ø 58mm ø end piece B 45mm warewashing L-shape equiv. no. 30014 L1 150mm L2 90mm		
For models:	APS60, APSE60, FW50		

Зип Общепит

vsezip.ru

+7(812)987-08-81



1

GEV No.	512364	Ref. No.	H201029
description	formed hose end piece A ext. ø 60mm end piece A int. ø 45mm AD2 ø 45mm ø end piece B 29mm warewashing L-shape equiv. no. H201029		
For models:	DP35-2, DP35D-2, DP40-2, DP40D-2, GS-X1021-2, GS-X1021-2rib, GS-X1021-WEH-2, GS-X1021-WEH-2rib, STS43-2, STS43D-2, STS48-2, STS48D-2, TDN4-2rib		



1

GEV No.	530577	Ref. No.	33454
description	formed hose L 350mm warewashing L-shape equiv. no. 200750 ID ø 60mm		
For models:	CA120, CA55, CA90, CAP7, CAP7E, ED550, ED650E, ED650S, RCA1100, RCA1200, RCA1200i, SO55, SO55-400V3-50Hz-MARINE, SO55-440V3-60Hz-MARINE, SO55E		



1

GEV No.	524515	Ref. No.	25225
description	formed hose end piece A ext. ø 75mm end piece A int. ø 58mm AD2 ø 75mm ø end piece B 59mm inlet hose warewashing L-shape Qty 1 black L2 155mm L1 160mm		
For models:	ED600-95, ED650S, ED700, ED900, EDI5, K80F, K80G, LO60, LO61		



1

GEV No.	512134	Ref. No.	33743
description	formed hose warewashing L-shape		
For models:	C35, C43, C43D, C48, C48D, CDN3, CDN4, CR43, CR43D, CR48, CR48D, SP35, SP35D, SP40, SP40D, SPB35, SPR36, SPR36D, SPR41, SPR41D		



1

GEV No.	512129	Ref. No.	29532
description	formed hose end piece A ext. ø 75mm end piece A int. ø 59mm AD2 ø 75mm ø end piece B 59mm warewashing L-shape equiv. no. 29532		
For models:	C81, C81E, C81EBT, C90, C90DE, C90E, C90EBT, C98, ED650E, ED650E-90, ED650S-90, ED700-90, LO50, LO50E, LO62, LO78, RLO50, SMW15, SMW15E, SP81, SP81E, US-X501		



1

GEV No.	512381	Ref. No.	200612 36296
description	formed hose warewashing L-shape		
For models:	60EBT, AP53E, AP60E, C53DE, C53E, C60DE, C60E, C68DE, C68E, C68EBT, C6DE, C6E, C6EBT, DP45DE, DP45E, DP50DE, DP50E, DP50EBT, SP45DE, SP45E, SP50DE, SP50E, SP50E-400V3-50Hz-MARINE, SP50E-440V3-60Hz-MARINE, SP5DE, SP5E, SP68DE, SP68E, ST53DE, ST53E, ST60DE, ST60E, ST60EBT		



1

GEV No.	512135	Ref. No.	32984
description	formed hose end piece A int. ø 51mm ø end piece B 52mm L 460mm warewashing L-shape W 150mm		
For models:	C81, C90, ED600-95, EDI5, LO60, LO61, SP81		



1

GEV No.	511365	Ref. No.	201017 H201017
description	formed hose warewashing L-shape equiv. no. 201017		
For models:	60BT, 60BT-3, 60EBT, C68EBT, C6EBT, DP50EBT, SD5BT, ST48EBT, ST60EBT		





Зип Общепит

vsezip.ru

+7(812)987-08-81

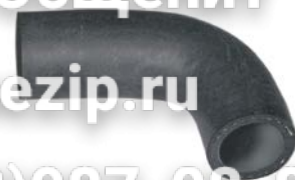
			
1			
GEV No.	512362	Ref. No.	25223
description	formed hose warewashing L-shape equiv. no. 25223		
For models:	M60, T5-80, T6-80		

			
1			
GEV No.	512131	Ref. No.	32881
description	formed hose warewashing L-shape equiv. no. 32881		
For models:	C3, C4, C43, C43D, C48, C48D, CR43, CR43D, CR48, CR48D, SP35, SP35D, SP40, SP40D, SPR36, SPR36D, SPR41, SPR41D		

			
1			
GEV No.	512356	Ref. No.	26907
description	formed hose warewashing L-shape equiv. no. 26907		
For models:	APS48, APS48B, APS53, APSE48, APSE53, CM48, CMD48, FW40, FW40B, FW45, NK48, NKD48, T3-80, T4-80, T5-80, T6-80, UNI48R, UNI48RD		

			
1			
GEV No.	512357	Ref. No.	33767
description	formed hose warewashing L-shape equiv. no. 33767		
For models:	APS43, APS48, APS48B, APS53, APS60, APSE43, APSE48, APSE53, FW35, FW40, FW40B, FW45, FW50		

			
1			
GEV No.	512355	Ref. No.	26909
description	formed hose warewashing L-shape equiv. no. 26909		
For models:	APS43, APS48B, APSE43, E50, FW35, FW40B, M60		

			
1			
GEV No.	512366	Ref. No.	35454
description	formed hose warewashing L-shape equiv. no. 35454		
For models:	C43-2, C48-2, C48D-2, C48E, DP40D-rib2, DP40-rib2, GS-X1011-2, GS-X1011-WEH-2, RSP40, RSP40A, SP35-2, SP40-2, SP40D-2, SP40E, ST43DE, ST43E, ST48DE, ST48E, STS48D-rib2, STS48-rib2, TDN4-2rib		

			
1			
GEV No.	512361	Ref. No.	28421
description	formed hose warewashing L-shape equiv. no. 28421		
For models:	T3-80, T4-80		

			
1			
GEV No.	512367	Ref. No.	H201030
description	formed hose warewashing L-shape equiv. no. H201030		
For models:	C43-2, C48-2, GS-X1011-2, GS-X1011-WEH-2, GS-X1021-2, GS-X1021-2rib, GS-X1021-WEH-2, GS-X1021-WEH-2rib, SP35-2, SP40-2, TDN4-2rib		

			
1			
GEV No.	512118	Ref. No.	31236
description	formed hose warewashing L-shape equiv. no. 31236		
For models:	TS48, UNI48C, UNI48CD		

			
1			
GEV No.	512380	Ref. No.	201059 35498
description	pressure hose L-shape		
For models:	C35E, C43-2, C43DE, C43E, C46DE, C46E, C48-2, C48D-2, C48E, DP35-2, DP35D-2, DP40-2, DP40D-2, DP40D-rib2, DP40-rib2, RSP40, RSP40A, SP35-2, SP35DE, SP35E, SP40-2, SP40D-2, SP40DE, SP40E, ST43DE, ST43E, ST48DE, ST48E, ST48EBT, STS43-2, STS43D-2, STS48-2, STS48D-2, STS48D-rib2, STS48-rib2, TDN4-2rib		



Зип Общепит

vsezip.ru

+7(812)987-08-81

with branch



GEV No.	511208	Ref. No.	200768
description	formed hose warewashing equiv. no. 200768 with piggyback		



GEV No.	512130	Ref. No.	25227
description	formed hose ID ø 50mm S-shape warewashing equiv. no. 25227		
For models:	C90DE2, C90E2, C90EBT2, ED630-90, ED650E, ED650E-90, ED650S, ED650S-90, EDI4, HD40ALTABT, HD40BT, K80F, K80G, LO56		



GEV No.	512132	Ref. No.	33583
description	formed hose warewashing U-shape		
For models:	60BT, 60BT-3, C53, C53D, C60, C60D, DP45, DP45D, DP50, DP50D, DP50D-115V, RSP50, RSP50A, SD5BT, SP45, SP45D, SP50, SP50-400V, SP50-440V, SP50D, STS53, STS53D, STS60, STS60D, TN-TDN5, TN-TDN6, VS-X313, VS-X313-LP-DOS, VS-X515, VS-X515-LP-DOS		



GEV No.	512120	Ref. No.	30453
description	formed hose S-shape warewashing equiv. no. 30453		
For models:	UNI60C		

form S



GEV No.	511479	Ref. No.	201004 H201004
description	formed hose hose ext. ø 65mm hose int. ø 50mm S-shape		
For models:	AC101, AC151, AC181, AC201, AC241, AC91, EDT100, EDT140, EDT170, EDT200, EDT230, EDT85		



GEV No.	512119	Ref. No.	30460
description	formed hose S-shape warewashing equiv. no. 30460		
For models:	UNI53C		



GEV No.	512360	Ref. No.	30466
description	formed hose S-shape warewashing equiv. no. 30466		
For models:	UNI60C		



Зип Общежит

miscellaneous

vsezip.ru

+7(812)987-08-81



1

GEV No.	512123	Ref. No.	31150
description	formed hose S-shape warewashing equiv. no. 31150		
For models:	UNI53C		



1

GEV No.	512121	Ref. No.	31193
description	formed hose warewashing equiv. no. 31193		
For models:	E40-2F, TS43, UNI43C		

form U



1

GEV No.	512388	Ref. No.	37630
description	formed hose D1 ø 30mm D2 ø 34mm L 540mm Qty 1		
For models:	AP43E, AP48E, FW35E, FW40E		



1

GEV No.	512117	Ref. No.	31194
description	formed hose warewashing equiv. no. 31194		
For models:	E40-2F, TS43, UNI43C		



1

GEV No.	512032	Ref. No.	200611 36295
description	formed hose D1 ø 30mm D2 ø 37mm L 645mm Qty 1		
For models:	60EBT, C53DE, C53E, C60DE, C60E, C68E, C6DE, C6E, C6EBT, DP45DE, DP45E, DP50DE, DP50E, DP50EBT, SP45DE, SP45E, SP50DE, SP50E, SP50E-400V3-50Hz-MARINE, SP50E-440V3-60Hz-MARINE, SP5DE, SP5E, SP68E, ST53DE, ST53E, ST60DE, ST60E, ST60EBT		

for dishwashers

miscellaneous



1

GEV No.	530590	Ref. No.	200117 H200117
description	hose ED ø 15mm ID ø 8mm equiv. no. 200117 Qty supplied by meter		
For models:	60BT, 60BT-3, 60EBT, AP43E, AP48E, AP53E, AP60E, C35, C35E, C43-2, C43DE, C43E, C46DE, C46E, C48-2, C48D-2, C48E, C53DE, C53E, C6, C60DE, C60E, C68DE, C68E, C68EBT, C6D, C6DE, C6E, C6EBT, C81E, C81EBT, C90, C90DE, C90DE2, C90E, C90E2, C90EBT, C90EBT2, C98, CAP10, CAP10BT, CAP10DE, CAP12, CAP12DE, CAP12EBT, CAP15EBT, CAP7, CAP7E, CDN3, CDN4...(Other models you can see in the webshop)		



1

GEV No.	512132	Ref. No.	33583
description	formed hose warewashing U-shape		
For models:	60BT, 60BT-3, C53, C53D, C60, C60D, DP45, DP45D, DP50, DP50D, DP50D-115V, RSP50, RSP50A, SD5BT, SP45, SP45D, SP50, SP50-400V, SP50-440V, SP50D, STS53, STS53D, STS60, STS60D, TN-TDN5, TN-TDN6, VS-X313, VS-X313-LP-DOS, VS-X515, VS-X515-LP-DOS		



1



GEV No.	530589	Ref. No.	200113 H200113
description	hose ED ø 22mm ID ø 12mm L 1000mm		
For models:	AC101, AC151, AC181, AC201, AC241, AC91, EDT100, EDT140, EDT170, EDT200, EDT230, EDT85, HG2LR, HGLR, TR100, TR140, TR200, TR230, TR90, TR-E100, TR-E150, TR-E170, TR-E200, TR-E230, TR-E90		

Зип Общепит

vsezip.ru

+7(812)987-08-81

			
1			
GEV No.	512036	Ref. No.	31913
description	hose int. ø 1 14mm int. ø 2 18mm		
For models:	INDY48F, UNI48C, UNI48CD		

			
1			
GEV No.	512035	Ref. No.	37918 37918+28224
description	double nipple brass thread 1/2" - 3/4" Qty 1 pcs L1 7mm L2 19mm		
spare parts for	512035		
	GEV No.	517045	Ref. No. 28224
	O-ring EPDM thickness 1.78mm ID ø 21.95mm Qty 1 pcs		

fittings, hose and pipe connectors

hose connectors

without screw connection

			
1			
GEV No.	510842	Ref. No.	180403
description	T-piece plastic hose ø 13-13-13mm 3-way		
For models:	AC101, AC151, AC181, AC201, AC241, AC91, EDT100, EDT140, EDT170, EDT200, EDT230, EDT85, HG2LR, HGLR		

			
1			
GEV No.	511950	Ref. No.	35273
description	reducer thread 3/8" ET - 1/4" IT stainless steel		

fittings

double nipples

			
1			
GEV No.	506277	Ref. No.	332162
description	double nipple SS thread 3/8" - 3/4" Qty 1 pcs		

			
1			
GEV No.	510464	Ref. No.	33477
description	angle piece thread 1/4" IT - 3/8" IT brass		
For models:	C81, C81E, C81EBT, C90, C90DE, C90DE2, C90E, C90E2, C90EBT, C90EBT2, C98, CA120, CA55, CA90, CAP7, CAP7E, ED550, ED650E, ED650S, EDI13, EDI13-2, EDI13ALTA, EDI13ALTA-2, EDI13ALTABT, EDI13BT, EDI6, EDI6-2, EDI6BT, EDI8, EDI8-2, EDI8BT, HD130BT, HD60BT, HD80BT, LO134, LO134-2, LO134ALTA, LO134ALTA-2, LO50E, LO62, LO67, LO67-2, LO83, LO83-2, RCA1100, RCA1200, RCA1200i, RLO200, RLO300...(Other models you can see in the webshop)		

			
1			
GEV No.	506272	Ref. No.	190696
description	double nipple plastic thread 3/8" - 3/4" Qty 1 pcs		
For models:	HT100, HT150, HTP195, HTP205, HTP220		

			
1			
GEV No.	520821	Ref. No.	37667
description	angle piece thread 1/4" IT - 1/4" IT nickel-plated brass		
For models:	CAP7E		





Зип Общежит

nickel-plated brass

vsezip.ru

+7(812)987-08-81

			
1			
GEV No.	511951	Ref. No.	35272
description	angle piece thread 3/8" IT - 3/8" IT stainless steel		

			
1			
GEV No.	520201	Ref. No.	34426
description	hose connector nickel-plated brass straight thread 1/4" hose ø 12mm Qty 1 pcs		
For models:	C81, C81E, C81EBT, C90, C90DE, C90DE2, C90E, C90E2, C90EBT, C90EBT2, C98, CAP7E, EDI13, EDI13-2, EDI13ALTA, EDI13ALTA-2, EDI13ALTABT, EDI13BT, EDI6, EDI6-2, EDI6BT, EDI8, EDI8-2, EDI8BT, HD130BT, HD60BT, HD80BT, LO134, LO134-2, LO134ALTA, LO134ALTA-2, LO50, LO50E, LO62, LO67, LO67-2, LO83, LO83-2, RLO200, RLO300, RLO400, RLO50, SMW15, SMW15E, SP81, SP81E, US-X501		

hose connectors

plastic

			
1			
GEV No.	361997	Ref. No.	180331
description	hose connector plastic angled thread 3/8" hose ø 12mm Qty 1 pcs		
For models:	HT100, HT150, HTP195, HTP205, HTP220		

			
1			
GEV No.	361756	Ref. No.	35392
description	hose connector plastic angled thread 3/8" hose ø 6mm Qty 1 pcs		
For models:	60BT, AP43E, AP48E, AP53E, AP60E, C35E, C43-2, C43DE, C43E, C46DE, C46E, C48-2, C48D-2, C48E, C53DE, C53E, C6, C60DE, C60E, C68DE, C68E, C6D, C6DE, C6E, C81E, C90, C90DE, C90E, C90E2, C98, CAP10, CAP10DE, CAP12, CAP12DE, CAP7, CAP7E, CDN3, CDN4, DP35-2, DP35D-2, DP40-2, DP40D-2, DP40D-rib2, DP40-rib2, DP45DE, DP45E, DP50DE, DP50E, EDI13, EDI13-2...(Other models you can see in the webshop)		

brass

			
1			
GEV No.	520877	Ref. No.	34767
description	hose connector brass straight thread M14x1 hose ø 11mm Qty 1 pcs		
For models:	APS43, APS48, APS48B, APS53, APS60, C35, C43, C43D, C48, C48D, C53, C53D, C60, C60D, FW35, FW40, FW40B, FW45, FW50, SP35, SP35D, SP40, SP40D, SP45, SP45D, SP50, SP50-400V, SP50-440V, SP50D, SPB35		

producer-specific

			
1			
GEV No.	510912	Ref. No.	H290217
description	angle piece connection 3/8"-1/2" for pipe ø 12-14mm		
For models:	EDT100, EDT140, EDT170, EDT200, EDT230, EDT85, TR100, TR140, TR170, TR200, TR230, TR90, TR-E100, TR-E150, TR-E170, TR-E200, TR-E230		

			
1			
GEV No.	512021	Ref. No.	H200117+35392+2x33424+H180408+2x25803
description	conversion kit for T-piece		

			
1			
GEV No.	512058	Ref. No.	32352
description	hose connector angled connection 1/4" IT hose ø 10mm		
For models:	APS43, APS48, APS48B, APS53, APS60, APSE43, APSE48, APSE53, APSE60, C3, C35, C4, C43, C43ALTA, C43D, C48, C48D, C48DDL, C48DL, C53, C53D, C60, C60D, DP35, DP35D, DP40, DP40D, DP45, DP45D, DP50, DP50D, FW35, FW40, FW40B, FW45, FW50, GS-X1011, GS-X1011-WEH, GS-X1021, GS-X1021-WEH, RSP50, RSP50A, SP35, SP35ALTA, SP35D, SP40, SP40D, SP40DDL, SP40DL, SP45...(Other models you can see in the webshop)		



Зип Общепит

vsezip.ru

+7(812)987-08-81

			
1			
GEV No.	512245	Ref. No.	33544
description	hose connector thread 1/2" grommet ø 30mm ID ø 16mm grommet length 28mm total length 35mm ED ø 31.5mm		
For models:	60BT, 60BT-3, C43, C43ALTA, C48, C48D, C48DDL, C48DL, C53, C53D, C60, C60D, DP35, DP35D, DP40, DP40D, DP45, DP45D, DP50, DP50D, DP50D-115V, GS-X1011, GS-X1011-WEH, GS-X1021, GS-X1021-WEH, RSP50, RSP50A, SD5BT, SP35, SP35ALTA, SP40, SP40D, SP40DDL, SP40DL, SP45, SP45D, SP50, SP50-400V, SP50-440V, SP50D, STS43, STS43D, STS48, STS48D, STS53, STS53D, STS60, STS60D, TN-TDN5, TN-TDN6...(Other models you can see in the webshop)		



			
1			
GEV No.	512309	Ref. No.	31244
description	T-piece connectionmm plastic		
For models:	TS43		

			
2			
GEV No.	512025	Ref. No.	190315 33474
description	hose connector thread M16x1.25 for hose ID 11mm		
For models:	C98, CA120, CA55, CA90, CAP7, CAP7E, ED550, ED650E, ED650S, LO62, RCA1100, RCA1200, RCA1200i, SO55, SO55-400V3-50Hz-MARINE, SO55-440V3-60Hz-MARINE, SO55E		

			
1			
GEV No.	510984	Ref. No.	H190311
description	T-piece plastic		

			
1			
GEV No.	511274	Ref. No.	180415 H180415
description	manifold 4-way hose ø 12-12-12-12mm plastic		
For models:	DP35-2, DP35D-2, DP40-2, DP40D-2, DP40D-rib2, DP40-rib2, GS-X1021-2, GS-X1021-2rib, GS-X1021-WEH-2, GS-X1021-WEH-2rib, STS43-2, STS43D-2, STS48-2, STS48D-2, STS48D-rib2, STS48-rib2, TDN4-2rib		

			
1			
GEV No.	512311	Ref. No.	30435
description	T-piece plastic		
For models:	E40-2F, INDY53F, UNI53C, UNI60C		

			
1			
GEV No.	512093	Ref. No.	33817
description	T-piece connection 1: 12mm connection 2: 4mm		
For models:	C35, C43, C43ALTA, C43D, C48, C48D, C48DDL, C48DL, C53, C53D, C60, C60D, C81, C90, CA120, CA55, CA90, CR43, CR43D, CR48, CR48D, DP35, DP35D, DP40, DP40D, DP45, DP45D, DP50, DP50D, DP50D-115V, ED550, ED650E, ED650S, GS-X1011, GS-X1011-WEH, GS-X1021, GS-X1021-WEH, LO50, RCA1100, RCA1200, RCA1200i, RLO50, SP35, SP35ALTA, SP35D, SP40, SP40D, SP40DDL, SP40DL, SP45...(Other models you can see in the webshop)		
accessories for	512093		
	GEV No.	361083	Ref. No. —
	union nut T1: M10x1 for hose 6mm		

			
1			
GEV No.	512310	Ref. No.	30434
description	T-piece plastic for dishwashers		
For models:	INDY43F, INDY48F, TS48, UNI43C, UNI48C, UNI48CD		

			
1			
GEV No.	511277	Ref. No.	33502
description	T-piece thread 1/2" ø 18mm		
For models:	C43-2, C43DE, C43E, C46DE, C46E, C48-2, C48D-2, C53DE, C6, C60DE, C68DE, C68E, C6D, C6DE, CA120, CA55, CA90, CAP10, CAP12, CAP7, DP35-2, DP35D-2, DP40-2, DP40D-2, DP40D-rib2, DP40-rib2, ED550, ED650E, ED650S, GS-X1011, GS-X1011-2, GS-X1011-WEH, GS-X1011-WEH-2, GS-X1021, GS-X1021-2, GS-X1021-2rib, GS-X1021-WEH, GS-X1021-WEH-2, GS-X1021-WEH-2rib, RCA1100, RCA1200, RCA1200i, SO100, SO100-400V3-50Hz-MARINE, SO100-440V3-60Hz-MARINE, SO120, SO55, SO55-400V3-50Hz-MARINE, SO55-440V3-60Hz-MARINE, SP35-2...(Other models you can see in the webshop)		



water cycle components

supply filters

			
1			
GEV No.	510836	Ref. No.	620209 H620209
description	supply filter thread 3/4" ET - 3/4" IT total length 76mm plastic		
For models:	CAP15EBT		

ancillary products

clamps

hose clamps

DIN 3017 - W2

			
1			
GEV No.	520111	Ref. No.	33424
description	hose clamp ø 10-16mm width 9mm Qty 10 pcs DIN 3017		
For models:	60BT, AP43E, AP48E, AP53E, AP60E, C35, C35E, C43-2, C43DE, C43E, C46DE, C46E, C48-2, C48D-2, C48E, C53DE, C53E, C6, C60DE, C60E, C68DE, C68E, C6D, C6DE, C6E, C81E, C90, C90DE, C90DE2, C90E, C90E2, C98, CAP10, CAP10DE, CAP12, CAP12DE, CAP7, CAP7E, CDN3, CDN4, DP35-2, DP35D-2, DP40-2, DP40D-2, DP40D-rib2, DP40-rib2, DP45DE, DP45E, DP50DE, DP50E...(Other models you can see in the webshop)		

			
1			
GEV No.	520113	Ref. No.	25807
description	hose clamp ø 16-27mm width 9mm Qty 10 pcs DIN 3017		
For models:	60BT, 60BT-3, 60EBT, AP43E, AP48E, AP53E, AP60E, APS43, APS48, APS48B, APS53, APS60, APSE43, APSE48, APSE53, APSE60, BPN48, BPS43, BPS52, C3, C35, C35E, C4, C43, C43-2, C43ALTA, C43D, C43DE, C43E, C46DE, C46E, C48, C48-2, C48D, C48D-2, C48DDL, C48DL, C48E, C53, C53D, C53DE, C53E, C6, C60, C60D, C60DE, C60E, C68DE, C68E, C68EBT...(Other models you can see in the webshop)		

Зип Общепит

vsezip.ru

+7(812)987-08-81

			
1			
GEV No.	520117	Ref. No.	25809 450135 H450135
description	hose clamp stainless steel ø 40-60mm width 9mm Qty 5 pcs DIN 3017		
For models:	60BT, 60BT-3, 60EBT, AC101, AC151, AC181, AC201, AC241, AC91, AP43E, AP48E, AP53E, AP60E, APS43, APS48, APS48B, APS53, APS60, APSE43, APSE48, APSE53, APSE60, BPN48, BPS43, BPS52, C35E, C43-2, C43DE, C43E, C46DE, C46E, C48-2, C48D-2, C48E, C53, C53D, C53DE, C53E, C6, C60, C60D, C60DE, C60E, C68DE, C68E, C68EBT, C6D, C6DE, C6E, C6EBT...(Other models you can see in the webshop)		

DIN 3017 - W4

			
1			
GEV No.	520120	Ref. No.	25803
description	hose clamp SS W4 ø 12-20mm width 9mm Qty 1 pcs DIN 3017		
For models:	60BT, 60BT-3, 60EBT, AP43E, AP48E, AP53E, AP60E, APS43, APS48, APS48B, APS53, APS60, APSE43, APSE48, APSE53, APSE60, BPN48, BPS43, BPS52, C3, C35, C35E, C4, C43, C43-2, C43ALTA, C43D, C43DE, C43E, C46DE, C46E, C48, C48-2, C48D, C48D-2, C48DDL, C48DL, C48E, C53, C53D, C53DE, C53E, C6, C60, C60D, C60DE, C60E, C68DE, C68E, C68EBT...(Other models you can see in the webshop)		

measuring equipment

thermometers

built-in thermometers

			
1			
GEV No.	541095	Ref. No.	26236
description	thermometer mounting measurements 58x25.5mm 0 up to +120°C capillary pipe 3000mm probe ø 6.5mm probe L 20mm		
For models:	C81, C90, C98, CA120, CA55, CA90, CAP7, CM43, CM48, CM52, CM60, CMD43, CMD48, CMD52, CMD60, ED550, ED600-95, ED630-90, ED650E, ED650E-90, ED650S, ED650S-90, ED700, ED700-90, ED900, ED900-90, EDI13, EDI13ALTA, EDI5, EDI6, EDI8, INDY43F, INDY48F, INDY53F, INDY60F, K80F, K80G, LO122, LO134, LO134ALTA, LO50, LO60, LO61, LO62, LO67, LO78, LO83, M60, NK43, NK48...(Other models you can see in the webshop)		

water and beverage technology

ø52mm



GEV No.	541065	Ref. No.	450905 H450905
description	thermometer mounting ø 52mm t.max. 120°C 0 up to +120°C probe ø 6.5mm probe L 28mm capillary pipe 1500mm		

Зип Общепит

vsezip.ru

+7(812)987-08-81

GEV No.	560231	Ref. No.	33277
description	sheet metal screws ø 2.9mm L 9.5mm SS Qty 20 pcs DIN 7982/ISO 7050 head ø 5.5mm sunk head		
For models:	60BT, 60BT-3, 60EBT, APS43, APS48, APS48B, APS53, APS60, APSE43, APSE48, APSE53, APSE60, C35, C35E, C43, C43-2, C43ALTA, C43D, C43DE, C43E, C46DE, C46E, C48, C48-2, C48D, C48D-2, C48DDL, C48DL, C48E, C53, C53D, C53DE, C53E, C6, C60, C60D, C60DE, C60E, C68DE, C68E, C68EBT, C6D, C6DE, C6E, C81, C81E, C81EBT, C90, C90DE, C90DE2...(Other models you can see in the webshop)		

fastening material

screws

sheet metal screws



GEV No.	560095	Ref. No.	25684
description	sheet metal screws ø 2.9mm L 9.5mm SS Qty 20 pcs DIN 7981/ISO 7049 head ø 5.6mm oval head		
For models:	60BT, 60BT-3, AP43E, AP48E, APS43, APS48, APS48B, APS53, APS60, APSE43, APSE48, APSE53, APSE60, BPN48, BPS43, BPS52, C3, C4, C53, C53D, C6, C60, C60D, C6D, DP35, DP35D, DP40, DP40D, DP45, DP45D, DP50, DP50D, DP50D-115V, E40, E40-2F, E43, E50, ED900-90, FW35, FW35E, FW40, FW40B, FW40E, FW45, FW50, LO122, RSP50, RSP50A, SD5BT, SP45...(Other models you can see in the webshop)		

GEV No.	560459	Ref. No.	260706 34815
description	screw ø 3.3mm L 13mm SS Qty 1 pcs intake Phillips head ø 4mm		
For models:	60EBT, AP53E, AP60E, C35E, C43-2, C43ALTA, C43DE, C43E, C46DE, C46E, C48-2, C48D-2, C48DDL, C48DL, C48E, C53DE, C53E, C6, C60DE, C60E, C68DE, C68E, C68EBT, C6D, C6DE, C6E, C6EBT, CDN3, CDN4, DP35-2, DP35D-2, DP40-2, DP40D-2, DP40D-rib2, DP40-rib2, DP45DE, DP45E, DP50D-115V, DP50DE, DP50E, DP50EBT, GS-X1011-2, GS-X1011-WEH-2, GS-X1021-2, GS-X1021-2rib, GS-X1021-WEH-2, GS-X1021-WEH-2rib, RSP40, RSP40A, RSP50...(Other models you can see in the webshop)		

GEV No.	517795	Ref. No.	34503
description	screw ø 3.9mm L 9mm SS Qty 1 pcs for rinse arm		
For models:	APS43, APS48, APS48B, APS53, APS60, FW35, FW40, FW40B, FW45, FW50		

GEV No.	560100	Ref. No.	25714
description	sheet metal screws ø 3.5mm L 19mm SS Qty 20 pcs DIN 7981/ISO 7049 head ø 6.9mm oval head		
For models:	APS43, APS48, APS48B, APS53, APS60, APSE43, APSE48, APSE53, APSE60, C3, C4, C53, C53D, C60, C60D, CM43, CM48, CM52, CM60, CMD43, CMD48, CMD52, CMD60, DP35, DP35D, DP40, DP40D, DP45, DP45D, DP50, DP50D, E36, E40, E43, E50, ED600-95, ED630-90, ED650E-90, ED650S-90, ED700, ED700-90, ED900, ED900-90, EDI5, FW35, FW40, FW40B, FW45, FW50, INDY43F...(Other models you can see in the webshop)		

GEV No.	560450	Ref. No.	26691
description	countersunk screw thread M4 L 8mm SS DIN 965/ISO 7046 Qty 1 pcs intake Phillips head ø 7.3mm		
For models:	60BT, 60BT-3, 60EBT, APS43, APS48, APS48B, APS53, APS60, C35, C35E, C43, C43-2, C43ALTA, C43D, C43DE, C43E, C46DE, C46E, C48, C48-2, C48D, C48D-2, C48DDL, C48DL, C48E, C53, C53D, C53DE, C53E, C60, C60D, C60DE, C60E, C68DE, C68E, C68EBT, C6DE, C6E, C81, C81E, C81EBT, C90, C90DE, C90DE2, C90E, C90E2, C90EBT, C90EBT2, CDN3, CDN4...(Other models you can see in the webshop)		



Зип Общепит
vsezip.ru
77(812)987-08-81

flat-headed bolts



GEV No.	560062	Ref. No.	23699
description	flat-headed bolt thread M4 thread L 10mm SS DIN 7985/ISO 7045 Qty 20 pcs intake Phillips head ø 8mm head thickness 2mm		
For models:	60EBT, AP53E, AP60E, APS43, APS48, APS48B, APS53, APS60, APSE43, APSE48, APSE53, APSE60, C3, C35, C4, C43, C43ALTA, C43D, C48, C48D, C48DDL, C48DL, C53, C53D, C53DE, C53E, C60, C60D, C60DE, C60E, C68DE, C68E, C6DE, C6E, C81, C81E, C81EBT, C90, C90DE, C90DE2, C90E, C90E2, C90EBT, C90EBT2, C98, CA120, CA55, CA90, CAP10, CAP10BT...(Other models you can see in the webshop)		



GEV No.	560088	Ref. No.	25716 260105
description	hexagonal screw thread M6 thread L 20mm SS WS 10 Qty 20 pcs DIN 933 / ISO 4017		
For models:	60EBT, AP43E, AP48E, AP53E, AP60E, C35E, C43, C43-2, C43ALTA, C43D, C43DE, C43E, C46DE, C46E, C48, C48-2, C48D, C48D-2, C48DDL, C48DL, C48E, C53, C53D, C53DE, C53E, C6, C60, C60D, C60DE, C60E, C68DE, C68E, C68EBT, C6D, C6DE, C6E, C6EBT, C90EBT, CR43, CR43D, CR48, CR48D, DP35-2, DP35D-2, DP40-2, DP40D-2, DP40D-rib2, DP40-rib2, DP45DE, DP45E...(Other models you can see in the webshop)		



GEV No.	511004	Ref. No.	H260226
description	flat-headed bolt thread M4 thread L 12mm SS DIN 84/ISO 1207 Qty 1 pcs intake slotted L 14.5mm		
For models:	C68DE, C68E, CA120, CA55, CA90, ED550, ED650E, ED650S, EDT100, EDT140, EDT85, RCA1100, RCA1200, RCA1200i, SP68DE, SP68E, TR100, TR140, TR90, TR-E100, TR-E150, TR-E170, TR-E200, TR-E230		



GEV No.	560089	Ref. No.	25719
description	hexagonal screw thread M6 thread L 25mm SS WS 10 Qty 20 pcs DIN 933 / ISO 4017		
For models:	APS43, APS48, APS53, APS60, APSE43, APSE48, APSE53, APSE60, C90DE2, C90E2, C90EBT2, CDN3, CDN4, ED630-90, EDI13, EDI13ALTA, EDI6, EDI8, LO134, LO134ALTA, LO67, LO83, RLO200, RLO300, RLO400		



GEV No.	560529	Ref. No.	H260207
description	flat-headed bolt thread M4 thread L 25mm SS DIN 84/ISO 1207 Qty 1 pcs intake slotted head ø 7mm head thickness 2.5mm		
For models:	CA120, CA55, CA90, ED550, ED650E, ED650S, RCA1100, RCA1200, RCA1200i		



GEV No.	503122	Ref. No.	25728
description	hexagonal screw thread M8 thread L 10mm SS WS 13 Qty 1 pcs DIN 933 / ISO 4017		
For models:	AP53E, AP60E, BPN48, BPS43, BPS52, C81EBT, C90EBT2, DP45DE, DP45E, DP50DE, DP50E, E36, E40, E40-2F, ED700, ED900, EDI13-2, EDI13ALTA-2, EDI4, EDI6-2, EDI8-2, HD40ALTABT, HD40BT, HD60BT, HD80BT, INDY43F, INDY48F, INDY53F, INDY60F, LO134-2, LO134ALTA-2, LO56, LO67-2, LO83-2, ST53DE, ST53E, ST60DE, ST60E, TS43, TS48, UNI43C, UNI48C, UNI48CD, UNI53C, UNI60C		

hexagonal screws



GEV No.	560083	Ref. No.	25708
description	hexagonal screw thread M5 thread L 10mm SS WS 8 Qty 20 pcs DIN 933 / ISO 4017		
For models:	60BT, 60BT-3, APS43, APS48, APS48B, APS53, APS60, APSE43, APSE48, APSE53, APSE60, C3, C35, C35E, C4, C43, C43-2, C43ALTA, C43D, C48, C48-2, C48D, C48D-2, C48DDL, C48DL, C48E, C53, C53D, C6, C60, C60D, C68DE, C68E, C68EBT, C6D, C81, C81E, C81EBT, C90, C90DE, C90DE2, C90E, C90E2, C90EBT, C90EBT2, C98, CDN3, CDN4, CR43, CR43D...(Other models you can see in the webshop)		



GEV No.	560464	Ref. No.	25729
description	hexagonal screw thread M8 thread L 12mm SS WS 13 Qty 1 pcs head thickness 5mm DIN 933 / ISO 4017		
For models:	ED650S, ED650S-90, EDI13, EDI13ALTA, EDI6, EDI8, LO134, LO134ALTA, LO67, LO83, RLO200, RLO300, RLO400		



GEV No.	560084	Ref. No.	25705 H260126
description	hexagonal screw thread M5 thread L 16mm SS WS 8 Qty 20 pcs DIN 933 / ISO 4017		
For models:	60BT, 60BT-3, 60EBT, C53DE, C53E, C60, C60D, C60DE, C60E, C68DE, C68E, C68EBT, C81, C81E, C90, C90DE, C90DE2, C90E, C90E2, CA55, CAP10DE, CAP12DE, CAP7, CAP7E, CDN3, CDN4, CR43, CR43D, CR48, CR48D, DP50, DP50D, DP50DE, DP50E, DP50EBT, ED550, ED630-90, ED700-90, EDI13-2, EDI13ALTA-2, EDI13ALTABT, EDI13BT, EDI4, EDI6-2, EDI6BT, EDI8-2, EDI8BT, EDT100, EDT140, EDT170...(Other models you can see in the webshop)		

Зип-Общепит

cylinder head bolts

DIN 912/ISO 4762



1

GEV No.	560025	Ref. No.	25700
description	cylinder head bolt thread M4 thread L 10mm WS 3 SS Qty 20 pcs DIN 912/ISO 4762		
For models:	60BT, 60BT-3, AP43E, AP48E, AP53E, AP60E, APS43, APS48, APS48B, APS53, APS60, APSE43, APSE48, APSE53, APSE60, BPN48, BPS43, BPS52, C3, C35, C35E, C4, C43, C43-2, C43ALTA, C43D, C43DE, C43E, C46DE, C46E, C48, C48-2, C48D, C48D-2, C48DDL, C48DL, C48E, C53, C53D, C53E, C6, C60, C60D, C60E, C68DE, C68E, C6D, C6E, C81, C81E... (Other models you can see in the webshop)		



2

GEV No.	560402	Ref. No.	25990
description	cylinder head bolt thread M5 thread L 10mm L 15.5mm WS 4 SS Qty 1 pcs intake hexagonal DIN 912/ISO 4762		
For models:	APS43, APS48, APS53, APS60, APSE43, APSE48, APSE53, APSE60, C35, C43, C43ALTA, C43D, C48, C48D, C48DDL, C48DL, C53, C53D, C60, C60D, CDN3, CDN4, CR43, CR43D, CR48, CR48D, DP35, DP35D, DP40, DP40D, DP45, DP45D, DP50, DP50D, FW35, FW40, FW45, FW50, SP35, SP35ALTA, SP35D, SP40, SP40D, SP40DDL, SP40DL, SP45, SP45D, SP50, SP50-400V, SP50-440V... (Other models you can see in the webshop)		

knurled screws



1

GEV No.	510307	Ref. No.	261009 H261009
description	Thumb screw thread M6 H 3mm thread L 8mm ø 28mm SS		
For models:	C35, C35E, C43, C43-2, C43ALTA, C43D, C43DE, C43E, C46DE, C46E, C48, C48-2, C48D, C48D-2, C48DDL, C48DL, C48E, C6, C68DE, C68E, C68EBT, C6D, C6DE, C6E, C6EBT, C90DE2, C90E2, C90EBT2, C98, CA120, CA55, CA90, CAP10, CAP10BT, CAP10DE, CAP12, CAP12DE, CAP12EBT, CAP15EBT, CAP7, CAP7E, ED550, ED650E, ED650S, EDI13-2, EDI13ALTA-2, EDI13ALTABT, EDI13BT, EDI4, EDI6-2... (Other models you can see in the webshop)		

nuts

cap nuts



1

GEV No.	560136	Ref. No.	26761
description	cap nuts thread M5 WS 8 SS Qty 20 pcs DIN/ISO DIN 1587		
For models:	AP43E, AP48E, AP53E, AP60E, APS43, APS48, APS53, APS60, APSE43, APSE48, APSE53, APSE60, BPN48, C3, C4, CM43, CM48, CM52, CM60, CMD43, CMD48, CMD52, CMD60, DP35, DP35D, DP40, DP40D, DP45, DP45D, DP45DE, DP45E, DP50, DP50D, DP50DE, DP50E, DP50EBT, E36, E40, E40-2F, E43, E50, ED600-95, ED700-90, ED900-90, EDI5, FW35, FW35E, FW40, FW40E, FW45... (Other models you can see in the webshop)		

knurled nuts

vsezip.ru

1

GEV No.	512257	Ref. No.	34382
description	knurled nut thread M10L ø 30mm H 6.5mm SS		
For models:	60BT, 60BT-3, C35, C43, C43D, C48, C48D, C53, C53D, C60, C60D, C81, C90, DP35, DP35D, DP40, DP40D, DP45, DP45D, DP50, DP50D, DP50D-115V, GS-X1021, GS-X1021-WEH, LO50, RSP50, RSP50A, SD5BT, SP35, SP35D, SP40, SP40D, SP45, SP45D, SP50, SP50-400V, SP50-440V, SP50D, SP81, SPB35, STS43, STS43D, STS48, STS48D, STS53, STS53D, STS60, STS60D, TN-TDN5, TN-TDN6... (Other models you can see in the webshop)		



1

GEV No.	512212	Ref. No.	34998
description	knurled nut thread M10x1.5 ø 30mm H 6.4mm SS		
For models:	60EBT, C53DE, C53E, C60DE, C60E, C81, C81E, C81EBT, C90, C90DE, C90E, C90EBT, DP35-2, DP35D-2, DP40-2, DP40D-2, DP40D-rib2, DP40-rib2, DP45DE, DP45E, DP50DE, DP50E, DP50EBT, EDI13, EDI13ALTA, EDI6, EDI8, GS-X1021-2, GS-X1021-2rib, GS-X1021-WEH-2, GS-X1021-WEH-2rib, LO134, LO134ALTA, LO50, LO50E, LO67, LO83, RLO200, RLO300, RLO400, RLO50, SMW15, SMW15E, SP45DE, SP45E, SP50DE, SP50E, SP50E-400V3-50Hz-MARINE, SP50E-440V3-60Hz-MARINE, SP81... (Other models you can see in the webshop)		



1

GEV No.	510346	Ref. No.	H280409
description	knurled nut thread M17x1 ø 35mm H 6mm SS		

hexagonal nuts

DIN 934 / ISO 4032/8673



1

GEV No.	560340	Ref. No.	25773
description	hexagonal nut thread M4 H 3.2mm WS 7 SS DIN/ISO DIN 934 / ISO 4032/8673 Qty 1 pcs		
For models:	60BT, 60BT-3, 60EBT, AP43E, AP48E, AP53E, AP60E, APS43, APS48, APS48B, APS53, APS60, APSE43, APSE48, APSE53, APSE60, BPN48, BPS43, BPS52, C3, C35, C35E, C4, C43, C43-2, C43ALTA, C43D, C43DE, C43E, C46DE, C46E, C48, C48-2, C48D, C48D-2, C48DDL, C48DL, C48E, C53, C53D, C53DE, C53E, C6, C60, C60D, C60DE, C60E, C68DE, C68E, C68EBT... (Other models you can see in the webshop)		





Зип Общепит

vsezip.ru

7(812)987-08-81

			
1			
GEV No.	560131	Ref. No.	25773
description	hexagonal nut thread M4 H 3.2mm WS 7 SS DIN/ISO DIN 934 / ISO 4032/8673 Qty 20 pcs		

			
1			
GEV No.	560129	Ref. No.	25774
description	hexagonal nut thread M5 H 4mm WS 8 SS DIN/ISO DIN 934 / ISO 4032/8673 Qty 1 pcs		
For models:	60BT, 60BT-3, 60EBT, AP43E, AP48E, AP53E, AP60E, APS43, APS48, APS48B, APS53, APS60, APSE43, APSE48, APSE53, APSE60, BPN48, BPS43, BPS52, C3, C35, C35E, C4, C43, C43-2, C43ALTA, C43D, C43DE, C43E, C46DE, C46E, C48, C48-2, C48D, C48D-2, C48DDL, C48DL, C48E, C53, C53D, C53DE, C53E, C6, C60, C60D, C60DE, C60E, C68DE, C68E, C68EBT...(Other models you can see in the webshop)		

			
1			
GEV No.	511212	Ref. No.	25775
description	hexagonal nut thread M6 H 5mm WS 10 SS DIN/ISO DIN 934 / ISO 4032/8673 Qty 1 pcs		
For models:	60BT, 60BT-3, 60EBT, AP43E, AP48E, AP53E, AP60E, APS43, APS48, APS48B, APS53, APS60, APSE43, APSE48, APSE53, APSE60, BPN48, BPS43, BPS52, C3, C35, C35E, C4, C43, C43-2, C43ALTA, C43D, C43DE, C43E, C46DE, C46E, C48, C48-2, C48D, C48D-2, C48DDL, C48DL, C48E, C53, C53D, C53DE, C53E, C6, C60, C60D, C60DE, C60E, C68DE, C68E, C68EBT...(Other models you can see in the webshop)		

			
1			
GEV No.	560197	Ref. No.	26758
description	nut thread M10 H 8mm WS 17 SS DIN/ISO DIN 934 / ISO 4032/8673 Qty 1 pcs		
For models:	ED550, ED600-95, ED700-90, ED900-90, EDI5, LO122, LO60, LO61, LO78		

DIN 985			
			
1			
GEV No.	560140	Ref. No.	30194
description	hexagonal nut thread M4 H 4.8mm WS 7 Qty 20 pcs DIN/ISO DIN 985 self-locking		
For models:	60EBT, AP43E, AP48E, AP53E, AP60E, C43DE, C43E, C46DE, C46E, C53DE, C53E, C60DE, C60E, C68DE, C68E, C68EBT, C6DE, C6E, C6EBT, C98, DP45DE, DP45E, DP50DE, DP50E, DP50EBT, EDI13, EDI13-2, EDI13ALTA, EDI13ALTA-2, EDI6, EDI6-2, EDI8, EDI8-2, FW35E, FW40E, LO134, LO134-2, LO134ALTA, LO134ALTA-2, LO62, LO67, LO67-2, LO83, LO83-2, SP35DE, SP35E, SP40DE, SP40E, SP45DE, SP45E...(Other models you can see in the webshop)		

			
1			
GEV No.	560142	Ref. No.	25792
description	hexagonal nut thread M6 H 6mm SS WS 10 Qty 20 pcs DIN/ISO DIN 985 self-locking		

hexagonal nuts metric (without norm)			
			
1			
GEV No.	512313	Ref. No.	30436
description	nut		
For models:	E40-2F, INDY43F, INDY48F, INDY53F, INDY60F, TS43, TS48, UNI43C, UNI48C, UNI48CD, UNI53C, UNI60C		

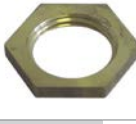
hexagonal nuts inch thread			
			
1			
GEV No.	511200	Ref. No.	15242
description	nut thread 1" H 6mm brass WS 45 Qty 1 pcs		
For models:	CDN3, CDN4, CM52, CM60, CMD52, CMD60, CR43, CR43D, CR48, CR48D, K80F, K80G, M60, NK52, NK60, NKD52, NKD60, SPR36, SPR36D, SPR41, SPR41D, T5-80, T6-80, UNI43R, UNI43RD, UNI48R, UNI48RD, UNI53R, UNI53RD		

			
1			
GEV No.	511309	Ref. No.	H270104
description	nut thread 1 1/2" ø 66mm H 9mm WS 51 brass Qty 1 pcs		
For models:	EDI13-2, EDI13ALTA-2, EDI13ALTABT, EDI13BT, EDI6-2, EDI6BT, EDI8-2, EDI8BT, EDT100, EDT140, EDT170, EDT200, EDT230, EDT85, LO134-2, LO134ALTA-2, LO67-2, LO83-2, TR100, TR140, TR170, TR200, TR230, TR90, TR-E100, TR-E150, TR-E170, TR-E200, TR-E230, TR-E90		

washers

spring rings

			
1			
GEV No.	560123	Ref. No.	260512
description	lock washer ID ø 6.3mm ED ø 11mm SS DIN127 Qty 20 pcs for thread M6		
For models:	AC151, CAP15EBT, EDT140, HG2LR, HGLR, HTP195, HTP205, HTP220, TR200, TR230		

washers

DIN 125A



1

GEV No.	560332	Ref. No.	25743
description	plain washer ID ø 4.3mm ED ø 9mm thickness 0.8mm SS Qty 1 pcs		
For models:	60BT, 60BT-3, 60EBT, AP43E, AP48E, AP53E, AP60E, APS43, APS48, APS48B, APS53, APS60, APSE43, APSE48, APSE53, APSE60, BPN48, BPS43, BPS52, C3, C35, C35E, C4, C43, C43-2, C43ALTA, C43D, C43DE, C43E, C46DE, C46E, C48, C48-2, C48D, C48D-2, C48DDL, C48DL, C48E, C53, C53D, C53DE, C53E, C6, C60, C60D, C60DE, C60E, C68DE, C68E, C68EBT...(Other models you can see in the webshop)		



1

GEV No.	560112	Ref. No.	25744
description	plain washer ID ø 5.3mm ED ø 10mm thickness 1mm SS Qty 20 pcs DIN 125A for thread M5		
For models:	60BT, 60BT-3, 60EBT, AP43E, AP48E, AP53E, AP60E, APS43, APS48, APS48B, APS53, APS60, APSE43, APSE48, APSE53, APSE60, BPN48, BPS43, BPS52, C3, C35, C35E, C4, C43, C43-2, C43ALTA, C43D, C43DE, C43E, C46DE, C46E, C48, C48-2, C48D, C48D-2, C48DDL, C48DL, C48E, C53, C53D, C53DE, C53E, C6, C60, C60D, C60DE, C60E, C68DE, C68E, C68EBT...(Other models you can see in the webshop)		



1

GEV No.	560333	Ref. No.	25745
description	plain washer ID ø 6.4mm ED ø 12mm thickness 1.6mm SS Qty 1 pcs DIN 125A for thread M6		
For models:	AP43E, AP48E, AP53E, AP60E, APS43, APS48, APS48B, APS53, APS60, APSE43, APSE48, APSE53, APSE60, BPN48, BPS43, BPS52, C3, C35, C4, C43, C43-2, C43ALTA, C43D, C48, C48-2, C48D, C48D-2, C48DDL, C48DL, C48E, C53, C53D, C6, C60, C60D, C6D, C81, C81E, C81EBT, C90, C90DE, C90DE2, C90E, C90E2, C90EBT, C90EBT2, C98, CA120, CA55, CA90...(Other models you can see in the webshop)		

DIN 9021



1

GEV No.	560117	Ref. No.	25746 260538
description	plain washer ID ø 6.4mm ED ø 18mm thickness 1.5mm SS Qty 20 pcs DIN 9021 for thread M6		
For models:	60EBT, AC101, AC151, AC181, AC201, AC241, AC91, AP43E, AP48E, AP53E, AP60E, BPS43, C35E, C43-2, C43DE, C43E, C46DE, C46E, C48-2, C48D-2, C48E, C6, C68EBT, C6D, C6EBT, C81E, C81EBT, C90DE, C90DE2, C90E, C90E2, C90EBT, C90EBT2, C98, CA120, CA55, CA90, CAP10, CAP10BT, CAP10DE, CAP12, CAP12DE, CAP12EBT, CAP7, CAP7E, CDN3, CDN4, CM48, CM52, CMD43...(Other models you can see in the webshop)		

tooth lock washers

DIN 6798A



1

GEV No.	512379	Ref. No.	33836
description	disc		
For models:	AP43E, AP48E, AP53E, AP60E, APS43, APS48, APS48B, APS53, APS60, APSE43, APSE48, APSE53, APSE60, FW35, FW35E, FW40, FW40B, FW40E, FW45, FW50		



1

GEV No.	512060	Ref. No.	33346
description	plain washer ID ø 13mm ED ø 37mm thickness 2.5mm SS Qty 1 pcs for wash arm support		
For models:	60BT, 60BT-3, APS43, APS48, APS48B, APS53, APS60, APSE43, APSE48, APSE53, APSE60, C35, C43, C43ALTA, C43D, C48, C48D, C48DDL, C48DL, C53, C53D, C60, C60D, DP35, DP35D, DP40, DP40D, DP45, DP45D, DP50, DP50D, DP50D-115V, FW35, FW40, FW40B, FW45, FW50, GS-X1011, GS-X1011-WEH, GS-X1021, GS-X1021-WEH, RSP50, RSP50A, SDSBT, SP35, SP35ALTA, SP35D, SP40, SP40D, SP40DDL...(Other models you can see in the webshop)		



1

GEV No.	512041	Ref. No.	25122
description	plain washer ID ø 14mm ED ø 23.5mm thickness 2mm plastic Qty 1 pcs for wash arm		
For models:	C3, C35, C4, C43, C48, C53, C60, DP35, DP35D, DP40, DP40D, DP45, DP45D, DP50, DP50D, ED630-90, ED650E, ED650E-90, ED650S, ED650S-90, ED700, ED900, GS-X1021, GS-X1021-WEH, K80F, STS43, STS43D, STS48, STS48D, STS53, STS53D, STS60, STS60D		

tooth lock washers

DIN 6798A



1

GEV No.	560126	Ref. No.	25753
description	tooth lock washer ID ø 5.2mm ED ø 10mm SS DIN/ISO DIN 6798A Qty 20 pcs for thread M5		



1

GEV No.	560127	Ref. No.	25750
description	tooth lock washer ID ø 6.2mm ED ø 11mm SS DIN/ISO DIN 6798A Qty 20 pcs for thread M6		
For models:	60BT, 60BT-3, 60EBT, AP43E, AP48E, AP53E, AP60E, APS43, APS48, APS48B, APS53, APS60, APSE43, APSE48, APSE53, APSE60, BPN48, BPS43, BPS52, C3, C35, C35E, C4, C43, C43-2, C43ALTA, C43D, C43DE, C43E, C46DE, C46E, C48, C48-2, C48D, C48D-2, C48DDL, C48DL, C48E, C53, C53D, C53DE, C53E, C6, C60, C60D, C60DE, C60E, C68DE, C68E, C68EBT...(Other models you can see in the webshop)		

Зип-Общепит

vsezip.ru

+7(812)987-08-81



Зип Общепит

vsezip.ru

+7(812)987-08-81

fasteners

clamps

hose clamps

DIN 3017 - W2



1

GEV No.	520111	Ref. No.	33424
description	hose clamp ø 10-16mm width 9mm Qty 10 pcs DIN 3017		
For models:	60BT, AP43E, AP48E, AP53E, AP60E, C35, C35E, C43-2, C43DE, C43E, C46DE, C46E, C48-2, C48D-2, C48E, C53DE, C53E, C6, C60DE, C60E, C68DE, C68E, C6D, C6DE, C6E, C81E, C90, C90DE, C90DE2, C90E, C90E2, C98, CAP10, CAP10DE, CAP12, CAP12DE, CAP7, CAP7E, CDN3, CDN4, DP35-2, DP35D-2, DP40-2, DP40D-2, DP40D-rib2, DP40-rib2, DP45DE, DP45E, DP50DE, DP50E...(Other models you can see in the webshop)		



1

GEV No.	520113	Ref. No.	25807
description	hose clamp ø 16-27mm width 9mm Qty 10 pcs DIN 3017		
For models:	60BT, 60BT-3, 60EBT, AP43E, AP48E, AP53E, AP60E, APS43, APS48, APS48B, APS53, APS60, APSE43, APSE48, APSE53, APSE60, BPN48, BPS43, BPS52, C3, C35, C35E, C4, C43, C43-2, C43ALTA, C43D, C43DE, C43E, C46DE, C46E, C48, C48-2, C48D, C48D-2, C48DDL, C48DL, C48E, C53, C53D, C53DE, C53E, C6, C60, C60D, C60DE, C60E, C68DE, C68E, C68EBT...(Other models you can see in the webshop)		



1

GEV No.	520117	Ref. No.	25809 450135 H450135
description	hose clamp stainless steel ø 40-60mm width 9mm Qty 5 pcs DIN 3017		
For models:	60BT, 60BT-3, 60EBT, AC101, AC151, AC181, AC201, AC241, AC91, AP43E, AP48E, AP53E, AP60E, APS43, APS48, APS48B, APS53, APS60, APSE43, APSE48, APSE53, APSE60, BPN48, BPS43, BPS52, C35E, C43-2, C43DE, C43E, C46DE, C46E, C48-2, C48D-2, C48E, C53, C53D, C53DE, C53E, C6, C60, C60D, C60DE, C60E, C68DE, C68E, C68EBT, C6D, C6DE, C6E, C6EBT...(Other models you can see in the webshop)		



GEV No.	520120	Ref. No.	25803
description	hose clamp SS W4 ø 12-20mm width 9mm Qty 1 pcs DIN 3017		
For models:	60BT, 60BT-3, 60EBT, AP43E, AP48E, AP53E, AP60E, APS43, APS48, APS48B, APS53, APS60, APSE43, APSE48, APSE53, APSE60, BPN48, BPS43, BPS52, C3, C35, C35E, C4, C43, C43-2, C43ALTA, C43D, C43DE, C43E, C46DE, C46E, C48, C48-2, C48D, C48D-2, C48DDL, C48DL, C48E, C53, C53D, C53DE, C53E, C6, C60, C60D, C60DE, C60E, C68DE, C68E, C68EBT...(Other models you can see in the webshop)		

miscellaneous



1

GEV No.	510923	Ref. No.	440817 H440817
description	clamping ring for shaft ø 10mm ID ø 9.4mm H 6mm		
For models:	C98, EDI5, HG2LR, HGLR, LO61, LO62		

retaining rings

DIN 471



1

GEV No.	512260	Ref. No.	32923
description	retaining ring shaft ø 14mm thickness 1.2mm steel DIN 471		
For models:	60BT, 60BT-3, C3, C35, C4, C43, C48, C53, C53D, C60, C60D, DP35, DP35D, DP40, DP40D, DP45, DP45D, DP50, DP50D, DP50D-115V, GS-X1021, GS-X1021-WEH, RSP50, RSP50A, SD5BT, SP45, SP45D, SP50, SP50-400V, SP50-440V, SP50D, STS43, STS43D, STS48, STS48D, STS53, STS53D, STS60, STS60D, TN-TDN5, TN-TDN6, VS-X313, VS-X313-LP-DOS, VS-X515, VS-X515-LP-DOS		



1

GEV No.	514030	Ref. No.	33160
description	retaining ring shaft ø 20mm thickness 1.3mm steel DIN 471		
For models:	APS43, APS48, APS48B, APS53, APS60, APSE43, APSE48, APSE53, APSE60, FW35, FW40, FW40B, FW45, FW50		

Зип Общепит

vsezip.ru

+7(812)987-08-81

screw caps

			
1			
GEV No.	510233	Ref. No.	290105 H290105
description	screw cap thread 1/2" thread L 12mm brass WS 27 head thickness 7mm		
For models:	AC101, AC151, AC181, AC201, AC241, AC91, EDT100, EDT140, EDT170, EDT200, EDT230, EDT85, HG2LR, HGLR, HTP195, HTP205, HTP220, TR100, TR140, TR170, TR200, TR230, TR90, TR-E100, TR-E150, TR-E170, TR-E200, TR-E230, TR-E90		

			
1			
GEV No.	358032	Ref. No.	28118
description	fine fuse size ϕ 10x38mm 25A rated 500V type Gg fast-acting Qty 1 pcs		
For models:	ED600-95, ED700-90, ED14, ED15, ED16, ED16-2, ED16BT, ED18, ED18-2, ED18BT, LO56, LO60, LO61, LO67, LO67-2, LO78, LO83, LO83-2, RLO200, RLO300		

			
1			
GEV No.	358021	Ref. No.	130260 H130260
description	fine fuse size ϕ 10x38mm 2A rated 500V type gl fast-acting Qty 1 pcs		
For models:	AC101, AC151, AC181, AC201, AC241, AC91, EDT100, EDT140, EDT170, EDT200, EDT230, EDT85, TR100, TR140, TR170, TR200, TR230, TR90, TR-E100, TR-E150, TR-E170, TR-E200, TR-E230		

			
1			
GEV No.	358023	Ref. No.	28048
description	fine fuse size ϕ 10x38mm 6A rated 500V type Gg fast-acting Qty 1 pcs		
For models:	E40, E43, E50, ED600-95, ED630-90, ED700-90, EDI13, EDI13-2, EDI13ALTA, EDI13ALTA-2, EDI13ALTABT, EDI13BT, EDI4, ED15, ED16, ED16-2, ED16BT, ED18, ED18-2, ED18BT, LO134, LO134-2, LO134ALTA, LO134ALTA-2, LO56, LO60, LO61, LO67, LO67-2, LO78, LO83, LO83-2, RLO200, RLO300, RLO400		

consumables

fuses

fine fuses

 ϕ 10x38mm 500V

			
1			
GEV No.	358028	Ref. No.	130248 H130248
description	fine fuse size ϕ 10x38mm 20A rated 500V type Gg fast-acting Qty 1 pcs		
For models:	AC101, AC151, AC181, AC201, AC241, AC91, EDT100, EDT140, EDT170, EDT200, EDT230, EDT85, HTP195, HTP205, HTP220, TR100, TR140, TR170, TR200, TR230, TR90, TR-E100, TR-E150, TR-E170, TR-E200, TR-E230		

Зип Общепит

vsezip.ru

+7(812)987-08-81

B		I	
bi-metal thermostats	8, 8	immersion heating elements	3
booster pumps I	45	indicator lights	20
booster pumps II	47	indicator lights (complete)	21
		industrial hoses	120
C		K	
cables	48	knurled nuts	132
cap nuts	132	knurled screws	132
clamps	129, 135		
coil heating elements	3	L	
condensators & interference suppression filters	47	lamps	20
consumables	136		
contactors	25	M	
control equipment	17	magnetic switches	16
control thermostats	8	measuring equipment	129
countersunk screws	130	microswitches	12
cylinder head bolts	132	motors	36
D		N	
digital timers	25	neon light bulbs	20, 21
door seals for dishwashers	113	Niplaflex hoses	120
dosing pumps	116	nuts	132
double nipples	126		
drain hoses	119	O	
drain pumps	46	operating capacitors	47
		O-rings	105
E			
electric accessories	48	P	
electrodes	36	plunger sockets	10
		position switches	13
F		pressure control hoses	120
fasteners	135	pressure switches	35
fastening material	130	probes	27
filters	47	programme timers	22
fine fuses	136	pumps	37
fittings	126	push/momentary push switches	11
flat-headed bolts	131	PVC supply hoses	119
float switches	15		
foam rubber gaskets	112	R	
foil heating elements	8	reducers	126
formed hoses	120	relays	26
fuses	48, 136	retaining rings	135
		ribbon cables	48
H		rocker/momentary rocker switches	11
heating elements	3	rotary switches	15
heating elements for pasta cookers	3		
hexagonal nuts	132	S	
hexagonal screws	131	safety bi-metal thermostats	8
hose clamps	129, 135	safety thermostats	9
hose connectors	126, 127	screw caps	136
hoses	119	screws	130

Зип Общепит

vsezip.ru

+7(812)987-08-81

sealing washers	110
shaft gaskets	113
sheet metal screws	130
snap locks	104
solenoid valves	100
spring rings	153
supply filters	129, 129
supply hoses	119
switches and momentary switches	11
system switches (ROLD)	13

T

tank inlets	119
terminals	48
thermostat gaskets	114
thermostats	8
time relays	27
timers	22
tooth lock washers	134

W

wash and rinse pumps	37
washers	134
water cycle components	129