

Зип Общепит

vsezip.ru

+7(812)987-08-81

612

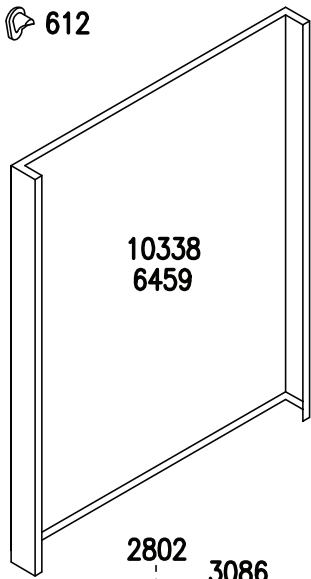

10338  
6459

2194

93  
897

3528

10293

10273

10846 (DA)

4350

10940

4350

35110

4251

2779

10539

10533

4092

4043

4090

10468

6126(DA)

4091

4042

6143

10790  
11120

4744

10808

2919

3165

3164

10471

11498

359

10294

6642

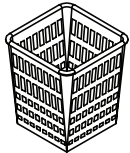

10472

4084

10321

11499

10294

6662

10784

10342

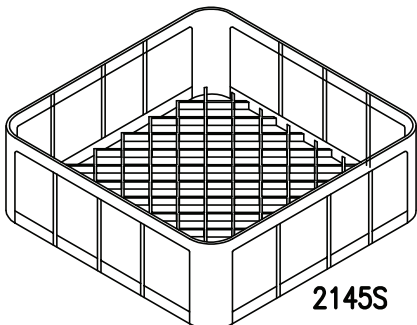

2145S

10321

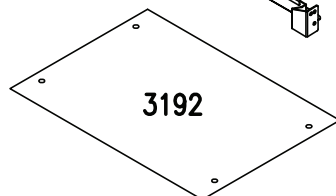

3192

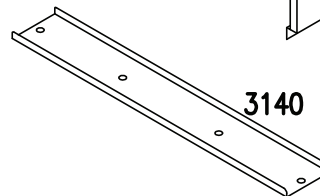

3140

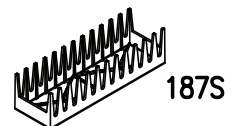





187S

Зип Общепит

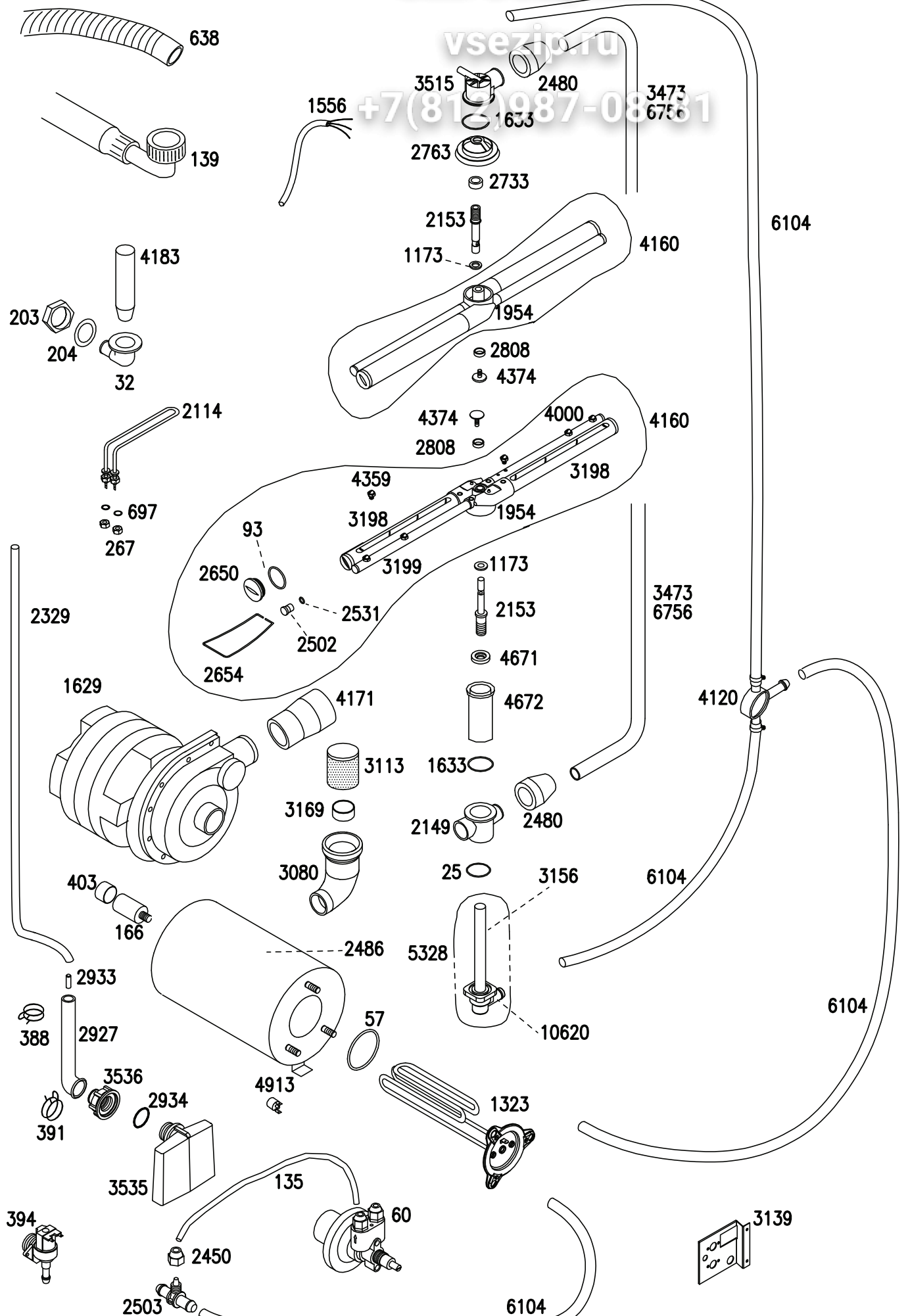
vsezip.ru

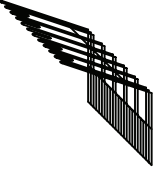
+7(812)987-0831

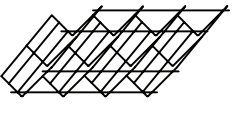
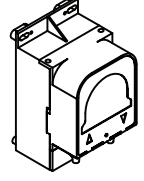
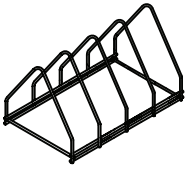
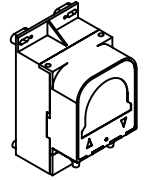
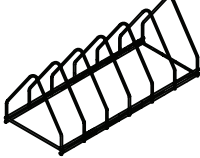
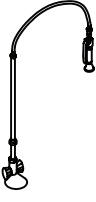
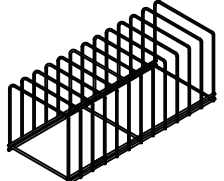
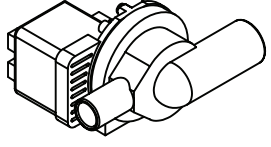
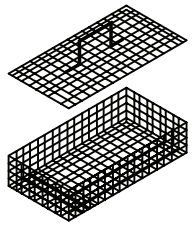
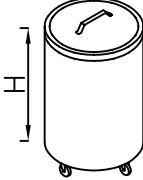
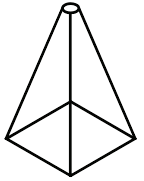
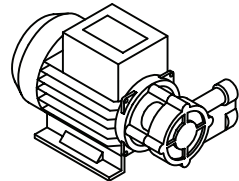
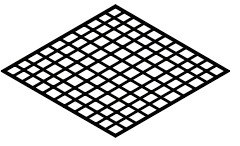
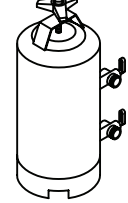
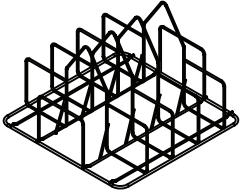

	INSERTO PORTACALICI (DAL CESTO 380X380)	CODICE		KIT DOSATORE ELETTRICO PER DETERSIVO LIQUIDO 1.5 Lt/h	CODICE	
		00002144		KIT DOSATORE ELETTRICO PER DETERSIVO LIQUIDO 3 Lt/h	00001206	
	INSERTO PORTABICCHIERI INCLINATO	CODICE		KIT DOSATORE ELETTRONICO REGOLABILE PER DETERSIVO LIQUIDO 0÷3 Lt/h	CODICE	
		00002252			00006223	
	SUPPORTO INOX PORTATEGLIE 4 DIVISORI  Lavapentole LP 55-65 Lavapentole LP 55-80	CODICE		DOSATORE ELETTRONICO REGOLABILE PER BRILLANTANTE LIQUIDO 0÷0.4 Lt/h	CODICE	
		OB005970			00006449	
	SUPPORTO INOX PORTATEGLIE 6 DIVISORI  Lavapentole LP 65-65 Lavapentole LP 125-80	CODICE		DOCCIONE COMPLETO	CODICE	
		OB005971			OB005942	
	SUPPORTO INOX PORTATEGLIE 12 DIVISORI  Lavapentole LP 65-65 Lavapentole LP 125-80	CODICE		POMPA DI SCARICO	CODICE	
		OB005972			00000379	
	CESTO PORTAOGGETTI CON COPERCHIO	CODICE		PATTUMIERA CON RUOTE Ø=400mm H=465mm CAPIENZA=58 Lt.	CODICE	
		OB009910			OB005941	
	PORTA SACCHETTI CREMA INOX	CODICE		POMPA SUPPLEMENTARE	CODICE	
		OB009903			00000380	
	GRIGLIA BASE DI SUPPORTO  Lavapentole LP 55-65 Lavapentole LP 55-80	CODICE		DEPURATORE	CODICE	
		OB006308			8 Lt.	OB005961
					12 Lt.	OB005962
					16 Lt.	OB005963
20 Lt.	OB005964					
	INSERTO CON INCLINATORE  Serie LP	CODICE		INCLINATORE PER CESTI IN PLASTICA DA mm. 400X400	CODICE	
		OB006309			00001877	

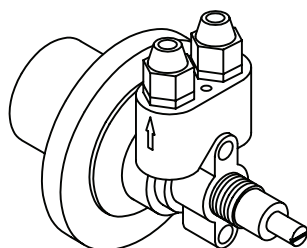
**DOSATRON**

60

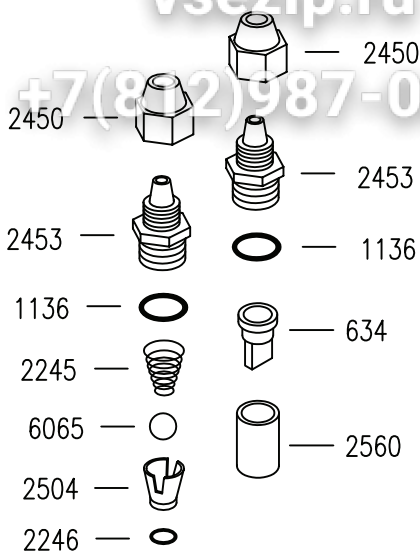

634	VALVOLA A LABBRO
1136	OR 3056
6065	SFERA 3/8"
2245	MOLLA CONICA INOX
2246	OR 2025
2450	SERRATUBO
2453	TAPPO VALVOLA
2504	DISTANZIATORE
2560	SEDE VALVOLA A LABBRO

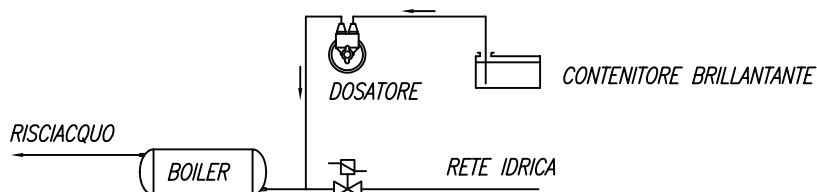
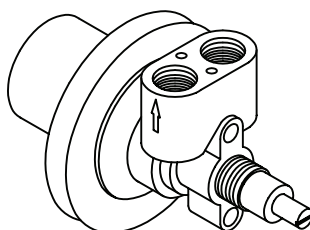

SCHEMA DI COLLEGAMENTO

**DOSATORE BRILLANTANTE "DOSATRON"****CARATTERISTICHE TECNICHE**

**FUNZIONAMENTO:** UTILIZZA LA PRESSIONE DI RISCIACQUO DELLA MACCHINA.

**COLLEGAMENTO IDRICO:** UTILIZZARE LA CANNUCCIA INSTALLATA NELLA MACCHINA PER COLLEGARE IL DOSATORE LATO "FRECCIA USCITA" ALL'IMPIANTO DI RISCIACQUO DELLA LAVASTOVIGLIE NEL TRATTO COMPRESO FRA L'ELETTROVALVOLA E IL BOILER. CON LA CANNUCCIA IN DOTAZIONE COLLEGARE IL DOSATORE LATO "FRECCIA ENTRATA" AL CONTENITORE DI BRILLANTANTE.

**FISSAGGIO MECCANICO:** UTILIZZARE IL DADO IN DOTAZIONE. N.B. IL DOSATORE PUO' AVERE QUALSIASI ORIENTAMENTO DI MONTAGGIO.

**INNESCO:** PROCEDERE NEL SEGUENTE MODO: SVITARE LA VITE DI REGOLAZIONE FINO ALL'ARRESTO, QUINDI SPINGERLA ALL'INTERNO PIU' VOLTE AFFINCHÉ IL BRILLANTANTE ASPIRATO RIEMPIA ENTRAMBE LE CANNUCCE.

**REGOLAZIONE:** AD OGNI RISCIACQUO INIETTA UNA QUANTITA' DI BRILLANTANTE REGOLABILE DA 0 A 4cm cubi, EQUIVALENTE AD UNA LUNGHEZZA ASPIRATA DELLA CANNUCCIA DA 0 A 30cm. LA PORTATA NULLA SI HA AVVITANDO COMPLETAMENTE LA VITE DI REGOLAZIONE (SENSO ORARIO), MENTRE LA PORTATA MASSIMA SI OTTIENE CON LA VITE SVITATA DI CIRCA 13 GIRI (SENSO ANTIORARIO). PER OGNI GIRO DELLA VITE LA DOSE VARIA DI 2cm ASPIRATI IN CANNUCCIA (0.3cm cubi/GIRO).

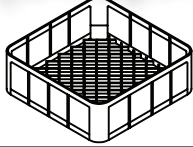
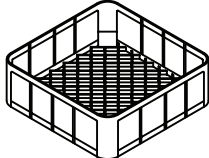
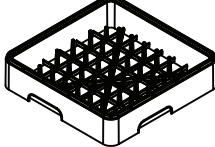
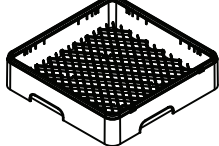
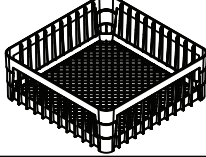
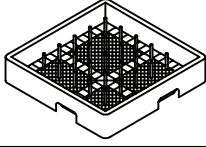
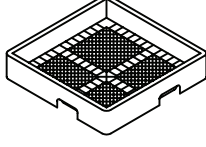
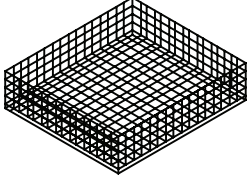
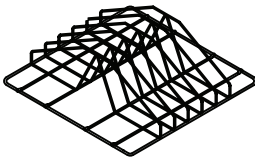
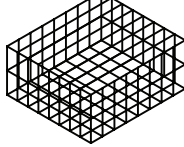
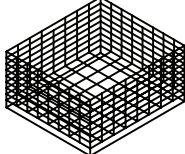
CODICE	DESCRIZIONE	CESTO	MODELLO APPARECCHIO
2461S	CESTO QUADRO 350 x 350 x 150 mm IN POLIPROPILENE		COMPACT 20 AE/AP 35.21
630S	CESTO QUADRO 380 x 380 x 150 mm IN POLIPROPILENE		GEMINI CF PROGRAM 25 CF AE/AP 38.25
2145S	CESTO QUADRO 400 x 400 x 150 mm IN PLASTICA		ALISEO 422 AE/AP 40.29 AL 40.28 E ALISEO 40.28 E
2492S	CESTO QUADRO 14 PIATTI 450 x 450 x 105 mm IN PLASTICA		AE/AP 45.30 AL 45.32 E ALISEO 45.32 E
3513	CESTO QUADRO BICCHIERI 450 x 450 x 110 mm IN PLASTICA		AE/AP 45.30 AL 45.32 E ALISEO 45.32 E
2491S	CESTO QUADRO 450 x 450 x 165 mm IN PLASTICA		ALISEO 450 AE/AP 45.30 AL 45.32 E ALISEO 45.32 E
237	CESTO QUADRO 12/18 PIATTI 500 x 500 x 105mm IN PLASTICA		AE/AP 50.32 - AP 50.35 AE/AP 1000 AL 50.34 E - AL 50.40 E GL 1040 - GL 1240
239	CESTO QUADRO PER POSATE ED UTENSILI 500 x 500 x 105mm IN PLASTICA		AE/AP 50.32 - AP 50.35 AE/AP 1000 AL 50.34 E - AL 50.40 E GL 1040 - GL 1240
5025	CESTO QUADRO 550 x 550 x 110mm INOX		AP 55.40 AL 55.45 E/P
5120	INSERTO PORTATEGLIE INOX		AP 55.40 AL 55.45 E/P
808	CESTO QUADRO 18 PIATTI 550 x 550 x 130mm		AL 55.45 E
803	CESTO QUADRO 550 x 550 x 130mm		AL 55.45 E

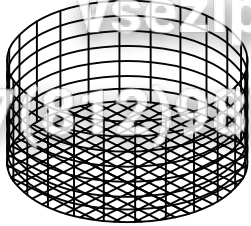
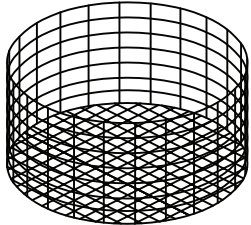
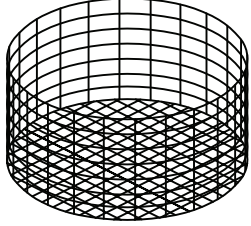
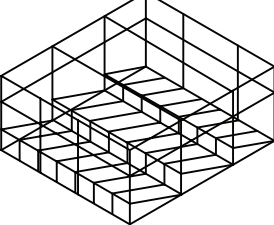
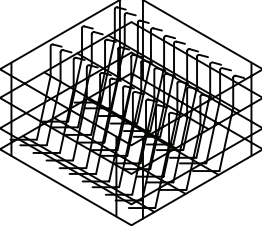
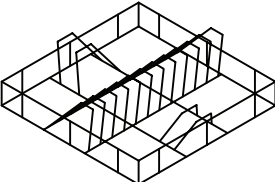
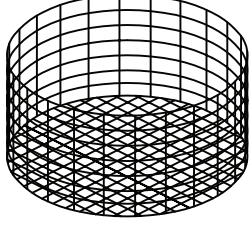
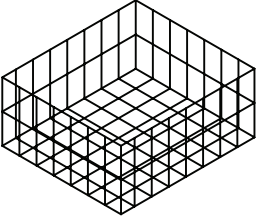
CODICE	DESCRIZIONE	CESTO	MODELLO APPARECCHIO
4065	CESTO BICCHIERI Ø 350x110 mm		AE/AP 35.21 (*) * = CON INSERTO INOX
195	CESTO TONDO Ø 360x180 mm		PROGRAM 25 CR
4073	CESTO BICCHIERI Ø 380x130 mm		PROGRAM 25 CF (*) AE/AP 38.25 (*) GEMINI CF (*) * = CON INSERTO INOX
63010	CESTO QUADRO CON ANGOLARI FONDO INCLINATO A 3 DIVISORI 380x380x175 mm		GEMINI CF PROGRAM 25 CF AE/AP 38.25
398	CESTO QUADRO CON ANGOLARI PER CALICI 380x380x200 mm		PROGRAM 25 CF AE/AP 38.25
493	CESTO 12 PIATTI 400x400x120 mm		ALISEO 422 AE/AP 40.29 ALISEO 40.28 E AL 40.28 E
2778	CESTO TONDO Ø 400x145 mm		ALISEO 422 (*) AE/AP 40.29 (*) * = CON INSERTO INOX
377	CESTO QUADRO CON ANGOLARI 400x400x250 mm		ALISEO 422 AE/AP 40.29 ALISEO 40.28 E AL 40.28 E

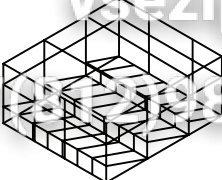
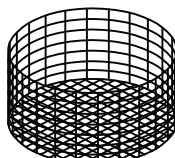
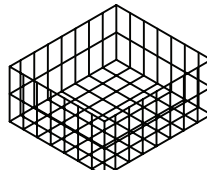
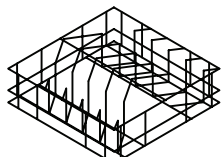
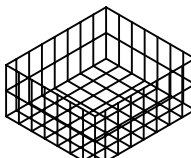
CODICE	DESCRIZIONE	CESTO	MODELLO APPARECCHIO
6296	CESTO QUADRO CON ANGOLARI FONDO INCLINATO A 3 DIVISORI 400x400x150 mm		ALISEO 422 AE/AP 40.29 ALISEO 40.28 E AL 40.28 E
5780	CESTO BICCHIERI Ø 350x170 mm		AE/AP 35.21 (*) (*) = CON INSERTO INOX
63011	CESTO QUADRO CON ANGOLARI 375x375x170 mm		PROGRAM 25 AE/AP 38.25
2492	CESTO QUADRO 14 PIATTI 450 x 450 x 105 mm		AE/AP 45.30 AL 45.32 E ALISEO 45.32 E
2491	CESTO QUADRO CON ANGOLARI 450 x 450 x 127 mm		ALISEO 450 AE/AP 45.30 AL 45.32 E ALISEO 45.32 E

- COD. 10326: SEPARATORE DA 9 BICCHIERI Ø148
- COD. 1880: SEPARATORE DA 16 BICCHIERI Ø110
- COD. 1881: SEPARATORE DA 25 BICCHIERI Ø87
- COD. 1882: SEPARATORE DA 36 BICCHIERI Ø72
- COD. 1833: SEPARATORE DA 49 BICCHIERI Ø60
- COD. 1834: SEPARATORE CON INCLINATORE DA 16 BICCHIERI
- COD. 1890: SEPARATORE CON INCLINATORE DA 25 BICCHIERI
- COD. 1891: SEPARATORE CON INCLINATORE DA 36 BICCHIERI

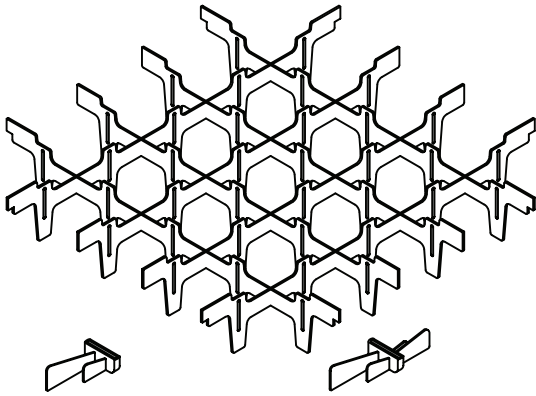

COD.10736  
INCL. SINGOLO

COD.10735  
INCL. DOPPIO

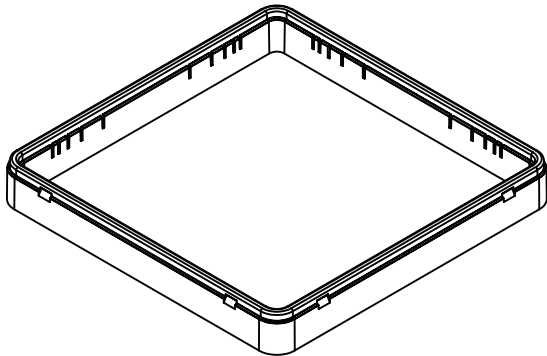

COD. 1879: TELAIO 50mm PER OGNI LIVELLO

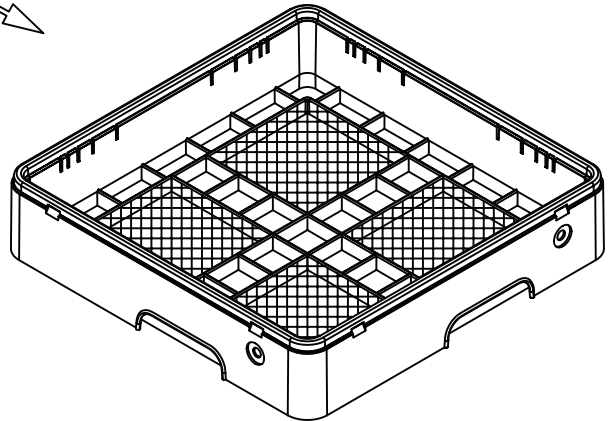

COD. 239: CESTO PER POSATE  
COD. 240: CESTO PER TAZZE E BICCHIERI

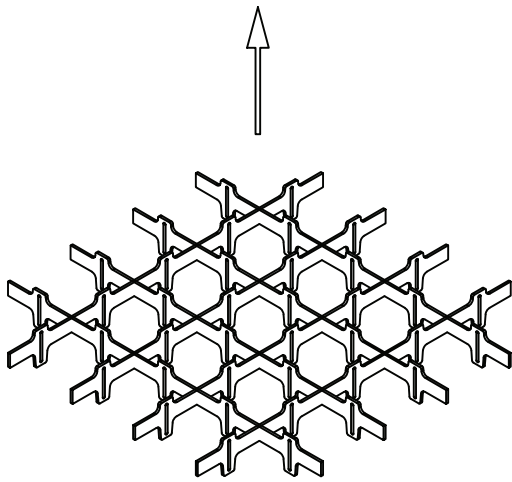

- COD. 10308 SEPARATORE A 9 SCOMPARTI PER TELAIO 50mm
- COD. 10309 SEPARATORE A 16 SCOMPARTI PER TELAIO 50mm
- COD. 10310 SEPARATORE A 25 SCOMPARTI PER TELAIO 50mm
- COD. 10311 SEPARATORE A 36 SCOMPARTI PER TELAIO 50mm
- COD. 10312 SEPARATORE A 49 SCOMPARTI PER TELAIO 50mm

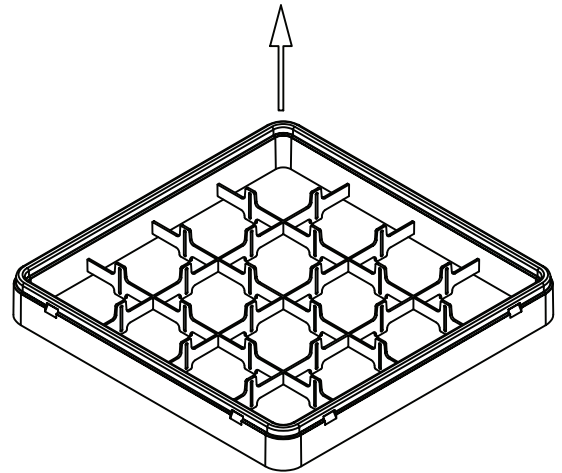

- COD. 10313 TELAIO 50mm A 9 SCOMPARTI
- COD. 10314 TELAIO 50mm A 16 SCOMPARTI
- COD. 10315 TELAIO 50mm A 25 SCOMPARTI
- COD. 10316 TELAIO 50mm A 36 SCOMPARTI
- COD. 10317 TELAIO 50mm A 49 SCOMPARTI

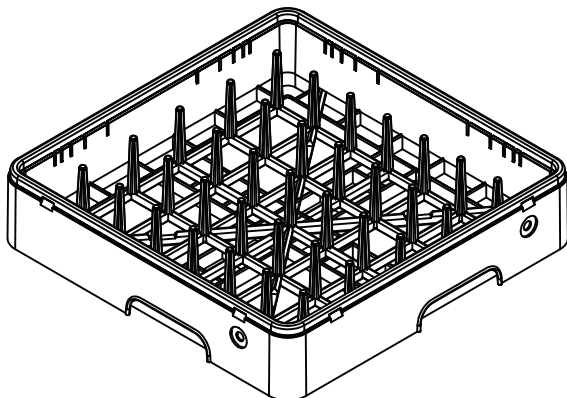



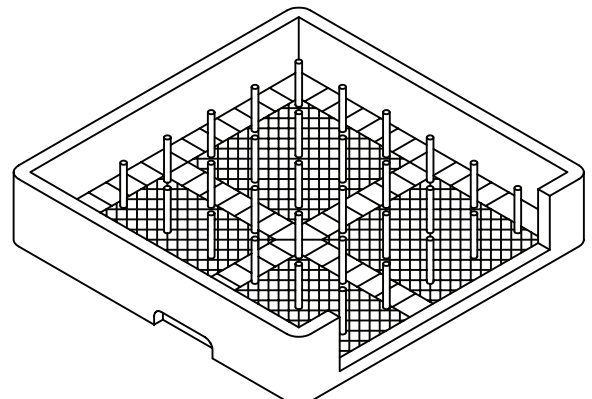

COD. 237: CESTO 18/12 PIATTI

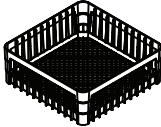
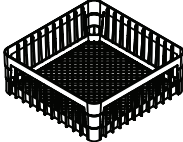
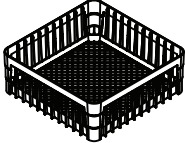
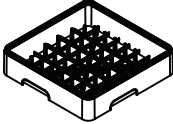
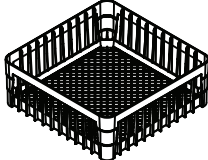
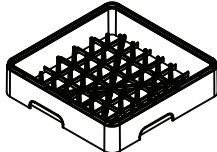
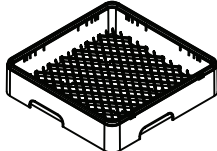

COD. 238: CESTO PER VASSOI



CODICE	DESCRIZIONE	CESTO	MODELLO APPARECCHIO
2461S	CESTO QUADRO 350 x 350 x 150 mm SENZA ANGOLARI INTERNI		AE/AP 35.21 COMPACT 20
630S	CESTO QUADRO 380 x 380 x 150 mm CON ANGOLARI INTERNI		AE/AP 38.25 GEMINI PROGRAM 25 CF
3295	CESTO QUADRO 400 x 400 x 150 mm SENZA ANGOLARI INTERNI		AE/AP 40.29 AL 40.28E ALISEO 40.28E
2145S	CESTO QUADRO 400 x 400 x 150 mm CON ANGOLARI INTERNI		AE/AP 40.29 AL 40.28E ALISEO 40.28E
493S	CESTO QUADRO 400 x 400 x 110 PIATTI		AE/AP 40.29 AL 40.28E ALISEO 40.28E
2491S	CESTO QUADRO 450 x 450 x 165 mm CON ANGOLARI INTERNI		AE/AP 45.30 AL 45.32 ALISEO 45.32
2492S	CESTO QUADRO 450 x 450 x 105 PIATTI		AE/AP 45.30 AL 45.32 ALISEO 45.32
3513	CESTO QUADRO 450 x 450 x 105 BICCHIERI		AE/AP 45.30 AL 45.32 ALISEO 45.32
3424	CESTO TONDO D350 H160 mm		AE/AP 35.21 COMPACT 20
3512	CESTO TONDO D380 H170 mm		AE/AP 38.25 GEMINI PROGRAM 25 CF
3497	CESTO TONDO D400 H180 mm		AE/AP 40.29 AL 40.28E ALISEO 40.28E

Seite	Kredtor Artikel Nr.	IT
001	00000612	FERMACAVO
001	00010338	PANN. POSTERIORE AP/AE 40.29
001	00010940	TIMER ELETTRONICO 1 TEMPO - MOD. NOALIA
001	00006188	ASS. CAPPOTTINA AP 40.28
001	00010293	GUARNIZIONE PER MICRO
001	00010273	DADO M10x0.75 OTTONE PER MICRO
001	00002194	ASS. CRICCO PORTA
001	00000093	OR 121
001	00000897	DADO INFERIORE BLOCCAGGIO
001	00003528	MICRO COMPLETO AE35
001	00004350	SUPPORTO PER CIRCUITO STAMPATO
001	00004251	MORSETTIERA PA76 3X6mmq 32A T125
001	00002779	FILTRO ANTIDISTURBO 0,47MF
001	00010539	PANN. COM. AP 40.28 AP SERIES
001	00004092	ASS. LAMPADA CON GEMMA NEUTRA 230V
001	00035110	PRESSOSTATO LIVELLO 55/30 LAVAST.
001	00010533	SCHEDA ELETTRICA AP 35/38/40
001	00004042	ASS. INTERRUTTORE CM - NA
001	00004091	ASS. LAMPADA CON GEMMA VERDE 230V
001	00004090	ASS. LAMPADA CON GEMMA ARANCIO 230V
001	00004043	ASS. PULSANTE AVVIO CICLO
001	00010468	MEMBRANA AD. AP 35-38-40
001	00006143	GUARNIZ. AUTOAD. X LABIRINTO mm15x4
001	00004744	ASS. TIRANTE PORTA DX/SX SERIE AP/AE
001	00003165	TESTINA PERNO A40-A50 DIS.1322
001	00003164	DADO BLOCCA PIASTRINA A35-A40-A50
001	00011498	ASS. CERNIERA PORTA DX AP/AE - FINITO
001	00010294	GUARNIZIONE LATERALE CERNIERA SERIE AE
001	00002919	GUIDA TIRANTE
001	00010471	FRANGIFLUTTI INT. VASCA DX AP/AE 35/38/40/45
001	00000359	TERMOSTATO DA 0 A 90° PER LAV.
001	00004084	SPUGNA ADESIVA mm20x2
001	00010321	SLITTA INTERNA DX - SX AP/AE 38-40
001	00010342	PANN. SOTTOPORTA AP/AE 40.29 BUGNA ARI + 90X30
001	00010784	ASS. PORTA AP 40.29 - PER CARROZZERIA UNIFICATA
001	00001875	INSERTO IN PLASTICA PORTAPIATTINI 12 POSTI
001	00003140	SUPP. POMPA A38-A40
001	00003192	PROTEZIONE FONDO PASSPORT 40.28
001	00021455	CESTO PLASTICA mm.400x400x150H
001	00006662	PIEDINO REGOLABILE ESAG. D.27
001	00011499	ASS. CERNIERA PORTA SX AP/AE - FINITO
001	00006642	INSERTO IN PLASTICA PER POSATE QUADRO
001	00010472	FRANGIFLUTTI INT. VASCA SX AP/AE 35/38/40/45
001	00010808	TAPPO FORO ø10 DOSATORE DETERSIVO
001	00010790	ASS. CARROZZ. AP/AE 40.29
001	00000486	COPERCHIO VALVOLA ANTIRIFLUSSO
001	00000123	OR 115
001	00006104	TUBO GOMMA 11,5 X 19 AIR WATER/10
001	00002803	GHIERA VALVOLA ANTIRIFLUSSO
001	00000144	SFERA 5/8' PTFE
001	00003086	GUARNIZIONE GOMMA d27xd40x1.5mm
001	00002802	CORPO VALVOLA ANTIRIFLUSSO DIS.1251
002	00000638	TUBO SCARICO øint 18 x 2000mm
002	00000139	TUBO CARICO MM1500 C/CURVA
002	00004183	TROPPOPIENO PLASTICA ø35x80 AP 35/38/40/45
002	00000203	DADO PILETTA NYLON
002	00000204	GUARNIZIONE GOMMA 59x45x2.5mm
002	00000032	PILETTA DI SCARICO
002	00002114	RESISTENZA 230V 2000W
002	00001556	CAVO ALIMENTAZIONE 3X2.5X2500
002	00003515	CONCHIGLIA SUP. GRIGIO C/INS. M12x1
002	00002480	MANICOTTO TUBO LAV. PROJECT
002	00001633	OR 147
002	00002733	DISTANZ. FULCRO INOX
002	00002763	ASS. FLANGIA BOCCAGLIO INOX
002	00002153	FULCRO INOX CROCIERA
002	00001173	RONDELLA TEFLON 16X10X2mm
002	00001954	DISTRIBUTORE 4RP DIS.1217
002	00002808	ANELLO PTFE X DISTRIB. 2RP(1955)

Seite	Kreditor Artikel Nr.	IT
002	00004374	VITE GODRONATA VER.OT DIS.406
002	00004160	ASS. CROCERA AP/PASSPORT 38/40 - C/FORNI LASERATI
002	00003473	RAMPA LAVAGGIO AP 40.28 IN GOMMA
002	00006104	TUBO GOMMA 11,5 X 19 AIR WATER/10
002	00004000	TUBO SPEZZONE SX RISCIAQUO A38-A40
002	00003198	TUBO SPEZZONE LAVAGGIO A 38 - A 40
002	00004359	UGELLO RISCIAQUO OTTONE CROMATO
002	00003199	TUBO SPEZZONE DX RISCIAQUO A38-A40
002	00004671	RONDELLA D'APPOGGIO DIS.1647
002	00002531	OR 106
002	00002502	TAPPO GIRELLO RISCIAQUO
002	00004171	MANICOTTO IN GOMMA MM30-38 A38-A40
002	00004672	CILINDRO COPRITIRANTE H=98 RESINA NORYL
002	00004120	DISTRIBUTORE A 3 VIE PLASTICA
002	00002149	CONCHIGLIA INFERIORE
002	00000025	OR 128
002	00003156	TIRANTE INOX PASSPORT/38.25-40.28
002	00003113	FILTRO POMPA PASSPORT A35-A38-A40
002	00003169	ANELLO X MANICOTTO A35-38-40 PLAST.
002	00002654	MOLLA AD ARCHETTO BRACCIO LAVAGGIO ø25
002	00003080	MANICOTTO ASPIRAZIONE A35-A38-A40
002	00002486	ASS. BOILER 3L AP 38.25 - AP 40.29
002	00005328	ASS. TIRANTE INF. A38 - A40
002	00010620	RACCORDO AD ANGOLO INF C/INS. M13x1 COL. NERO
002	00000057	OR PER FLANGIA
002	00004913	TERMOSTATO BIMETALLICO R.M.100o
002	00001323	RESISTENZA 220V 2500W C/FLANGIA BOILER A 3 FORI
002	00003139	SUPPORTO DOSATORE-TERMOSTATI
002	00000060	DOSATORE BRILLANTANTE A PRESSIONE DI RETE (60)
002	00000135	TUBO RILSAN MM.4 X 6 PA12
002	00002450	SERRATUBO DIS.506
002	00002503	PRESA DI PRESSIONE
002	00000394	ELETTROVALVOLA SING. 90o 230V
002	00003535	GABBIA D'ARIA IN POLIPROPILENE
002	00002934	OR 4081
002	00000391	FASCETTA BIFILARE 19.6x20.6
002	00000388	FASCETTA A FILO HLS/A14.8X15.9
002	00002927	RACCORDO ANTICONDENSA
002	00003536	DADO GABBIA D'ARIA
002	00002933	TUBETTO TENUTA GABBIA D'ARIA
002	00000166	CONDENSATORE 10 æF CON CODOLO
002	00000403	CAPPUCCIO PER CONDENSATORE 5 MICROF
002	00001629	POMPA LAVAGGIO 0.25 HP V230M 50Hz ROTAZIONE ORARIA
002	00002329	TUBO EPDM NERO mm5x10
002	00000093	OR 121
002	00000697	OR 112
002	00000267	DADO M10 X 1 OTTONE
003	00002144	INSERTO PORTACAUCI (DAL CESTO 380X380)
003	00002252	INSERTO PORTABICCHIERI INCLINATO
003	0B009910	CESTO PORTAOGGETTI CON COPERCHIO
003	0B009903	PORTA SACCHETTI CREMA INOX
003	00001206	KIT DOSATORE ELETTRICO PER DETERSIVO LIQUIDO 1.5 Lt/h
003	00004880	KIT DOSATORE ELETTRICO PER DETERSIVO LIQUIDO 3 Lt/h
003	00006223	KIT DOSATORE ELETTRONICO REGOLABILE PER DETERSIVO LIQUIDO 0:3 Lt/h
003	00006449	DOSATORE ELETTRONICO REGOLABILE PER BRILLANTANTE LIQUIDO 0:0.4 Lt/h
003	0B005942	DOCCIONE COMPLETO
003	00000379	POMPA DI SCARICO
003	0B005941	PATTUMIERA CON RUOTE ø=400mm H=465mm CAPIENZA=58 Lt
003	00000380	POMPA SUPPLEMENTARE
003	0B005961	DEPURATORE 8 Lt.
003	0B005962	DEPURATORE 12 Lt.
003	0B005960	DEPURATORE 16 Lt.
003	0B005964	DEPURATORE 20 Lt.
003	00001877	INCUNATORE PER CESTI IN PLASTICA DA mm. 400X400
004	00000060	DOSATORE BRILLANTANTE A PRESSIONE DI RETE (60)
004	00000634	VALVOLA X DOSATORE
004	00001136	OR 3056
004	00006065	SFERA 3/8' IN DELRIN
004	00002245	MOLLA INOX CONICA

Seite	Kreditor Artikel Nr.	IT
004	00002246	GUARNIZIONE OR 2025 X DOSAT.BRILL.
004	00002450	SERRATUBO DIS.506
004	00002453	TAPPO VALVOLA DOSAT. ARISTARCO
004	00002504	DISTANZ. DOSAT. ARISTARCO DIS.546
004	00002560	SEDE VALVOLA A LABBRO PER DOS.
005	00021455	CESTO PLASTICA mm.400x400x150H
006	00000493	CESTO 12 PIATTI MM400X400X120
006	00002778	CESTO RETE D. MM400X145H
006	00000377	CESTO MM400X400X250 C/ANG.
007	00006296	CESTO RETE MM400x400x150
008	00010736	INCLINATORE SINGOLO PER SEPARATORI
008	00010735	INCLINATORE DOPPIO PER SEPARATORI
008	00010326	SEPARATORE DA 9 BICCHIERI 148/9
008	00001880	SEPARATORE DA 16 BICCHIERI 110/16
008	00001881	SEPARATORE DA 25 BICCHIERI 87/25
008	00001882	SEPARATORE DA 36 BICCHIERI 72/36
008	00001883	SEPARATORE DA 49 BICCHIERI 60/49
008	00001884	SEPARATORE CON INCUNATORE DA 16 BICCHIERI
008	00001890	SEPARATORE CON INCUNATORE DA 25 BICCHIERI
008	00001891	SEPARATORE CON INCUNATORE DA 36 BICCHIERI
008	00001879	TELAIO PLASTICA AUMENTO H 50MM
008	00000239	CESTO PLASTICA RETE PER POSATE/UTEN
008	00000240	CESTO PLASTICA PER TAZZE/BICCHIERI
008	00010308	SEPARATORE A 9 SCOMPARTI PER TELAIO
008	00010309	SEPARATORE A 16 SCOMPARTI PER TELAI
008	00010310	SEPARATORE A 25 SCOMPARTI PER TELAI
008	00010311	SEPARATORE A 36 SCOMPARTI PER TELAI
008	00010312	SEPARATORE A 49 SCOMPARTI PER TELAI
008	00010313	TELAIO 50mm A 9 SCOMPARTI
008	00010314	TELAIO 50mm A 16 SCOMPARTI
008	00010315	TELAIO 50mm A 25 SCOMPARTI
008	00010316	TELAIO 50mm A 36 SCOMPARTI
008	00010317	TELAIO 50mm A 49 SCOMPARTI
008	00000237	CESTO PLASTICA 18 PIATTI PIANI/12
008	00000238	CESTO PLASTICA 8 VASSOI
009	00003295	CESTO QUADRO 400 x 400 x 150 mm SENZA ANGOLARI INTERNI
009	00021455	CESTO PLASTICA mm.400x400x150H
009	00004935	CESTO PLASTICA MM400X400X110 - PIATTI (9 F-11 L)
009	00003497	CESTO d.400mm x h180mm PLASTICA

Зип-Общепит

vsezip.ru

+7(812)987-08-81